

JOHN DEERE
WORLDWIDE COMMERCIAL & CONSUMER
EQUIPMENT DIVISION



Compact Utility Tractors
4500, 4600 and 4700

OMLVU11184 E0

OPERATOR'S MANUAL



 **WARNING:** The Engine Exhaust from this product contains chemicals known to the State of California to cause cancer, birth defects or other reproductive harm.

California Proposition 65 Warning

North American Version
Litho in U.S.A.

INTRODUCTION

Thank You for Purchasing a John Deere Product

We appreciate having you as a customer and wish you many years of safe and satisfied use of your machine.

Using Your Operator's Manual

This manual is an important part of your machine and should remain with the machine when you sell it.

Reading your operator's manual will help you and others avoid personal injury or damage to the machine. Information given in this manual will provide the operator with the safest and most effective use of the machine. Knowing how to operate this machine safely and correctly will allow you to train others who may operate this machine.

This manual and safety signs on your machine may also be available in other languages (see your John Deere dealer to order).

Sections in your operator's manual are placed in a specific order to help you understand all the safety messages and learn the controls so you can operate this machine safely. You can also use this manual to answer any specific operating or servicing questions. A convenient index located at the end of this book will help you to find needed information quickly.

The machine shown in this manual may differ slightly from your machine, but will be similar enough to help you understand our instructions.

RIGHT-HAND and LEFT-HAND sides are determined by facing in the direction the machine will travel when going forward. When you see a broken line arrow (----->), the item referred to is hidden from view.

Before delivering this machine, your dealer performed a predelivery inspection to ensure best performance.

Special Messages

Your manual contains special messages to bring attention to potential safety concerns, machine damage as well as helpful operating and servicing information. Please read all the information carefully to avoid injury and machine damage.



CAUTION: Avoid injury! This symbol and text highlight potential hazards or death to the operator or bystanders that may occur if the hazards or procedures are ignored.

IMPORTANT: Avoid damage! This text is used to tell the operator of actions or conditions that might result in damage to the machine.

NOTE: General information is given throughout the manual that may help the operator in the operation or service of the machine.

PRODUCT IDENTIFICATION

Record Identification Numbers

Compact Utility Tractor with Gear or Hydrostatic Transmissions

4500 PIN (190001 -)

4600 PIN (190001 -)

4700 PIN (190001 -)

If you need to contact an Authorized Service Center for information on servicing, always provide the product model and identification numbers.

You will need to locate the identifications numbers for the product. Record the information in the spaces provided below.

DATE OF PURCHASE:

DEALER NAME:

DEALER PHONE:



PRODUCT IDENTIFICATION NUMBER (A):



ENGINE SERIAL NUMBER (B):

<https://www.ebooklibonline.com>

Hello dear friend!

Thank you very much for reading.

Enter the link into your browser.

The full manual is available for immediate download.

<https://www.ebooklibonline.com>

TABLE OF CONTENTS

Safety	1
Operating	10
Replacement Parts	44
Service Intervals	45
Service Lubrication	47
Service Engine	49
Service Transmission.....	63
Service Electrical	66
Service Miscellaneous.....	72
Troubleshooting	79
Storage	84
Assembly	86
Specifications	88
Warranty	97
Index	100

All information, illustrations and specifications in this manual are based on the latest information at the time of publication. The right is reserved to make changes at any time without notice.

COPYRIGHT© 2000
Deere & Co.

John Deere Worldwide Commercial and
Consumer Equipment Division
Horicon, WI

All rights reserved
Previous Editions
COPYRIGHT© 1999

OMLVU11184 E0 - English

SAFETY

Understanding The Machine Safety Labels

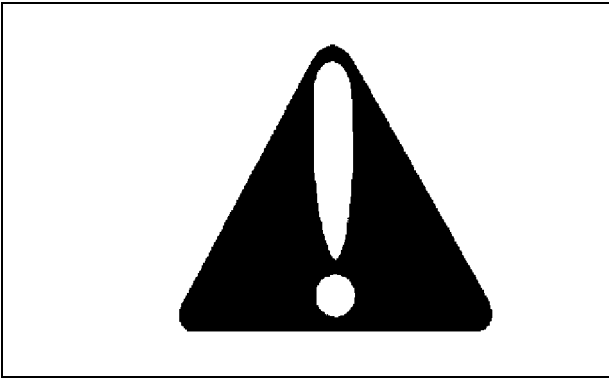

The machine safety labels shown in this section are placed in important areas on your machine to draw attention to potential safety hazards.

On your machine safety labels, the words DANGER, WARNING, and CAUTION are used with this safety-alert symbol, (▲). DANGER identifies the most serious hazards.

The operator's manual also explains any potential safety hazards whenever necessary in special safety messages that are identified with the word, CAUTION, and the safety-alert symbol, (▲).

CAUTION: READ OPERATOR'S MANUAL

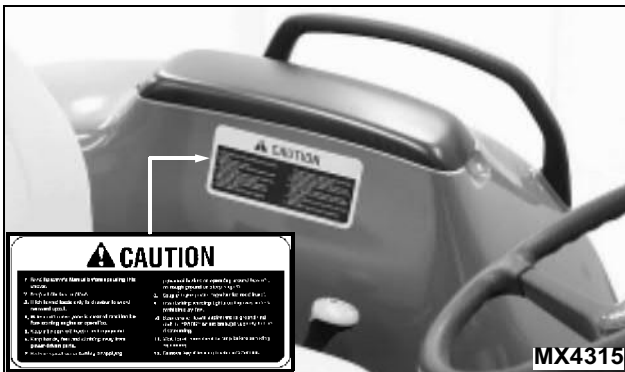

1. Read Operator's Manual before operating this tractor.
2. Keep all shields in place.
3. Hitch towed loads only to drawbar to avoid rearward upset.
4. Make certain everyone is clear of machine before starting engine or operation.
5. Keep all riders off tractor and equipment.
6. Keep hands, feet and clothing away from power-driven parts.
7. Reduce speed when turning or applying individual

brakes or operating around hazards on rough ground or steep slopes.

8. Couple brake pedals together for road travel.
9. Use flashing warning lights on highway unless prohibited by law.
10. Stop engine, lower implement to ground and shift to "PARK" or set brake(s) securely before dismounting.
11. Wait for all movement to stop before servicing machinery.
12. Remove key if leaving tractor unattended.

WARNING: AVOID INJURY FROM PTO

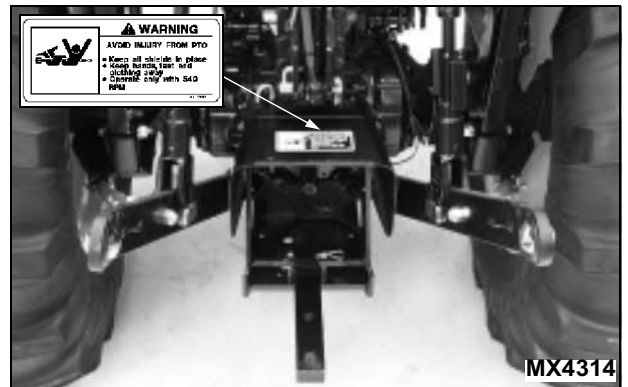

- Keep all shields in place.
- Keep hands, feet and clothing away.
- Operate with only 540 RPM.

CAUTION: HOT SURFACE

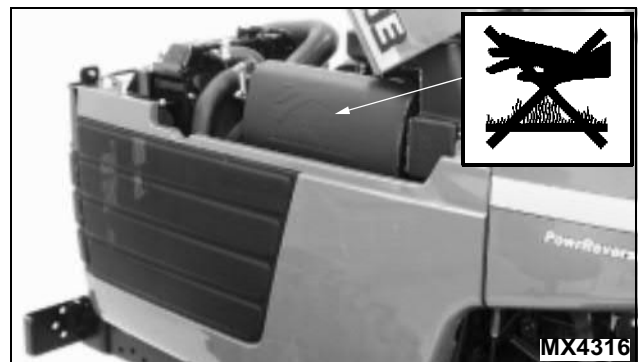

Picture Note: No-text warning molded into muffer.

DO NOT touch engine muffer, it may be hot.

SAFETY

WARNING: AVOID CRUSHING



Picture Note: Label attached to left fender when tractor is equipped with a fixed ROPS

Do not jump if machine tips
USE SEAT BELT

WARNING: AVOID CRUSHING



Picture Note: Label attached to right fender when tractor is equipped with a folding ROPS

- Keep Rollover Protective Structure fully extended.
- Do not jump if machine tips.
- Use seat belt.

When structure must be down;

- Do not use seat belt.
- Drive with extra care.

DANGER-POISON: SHIELD EYES, EXPLOSIVE GASES CAN CAUSE BLINDNESS OR INJURY

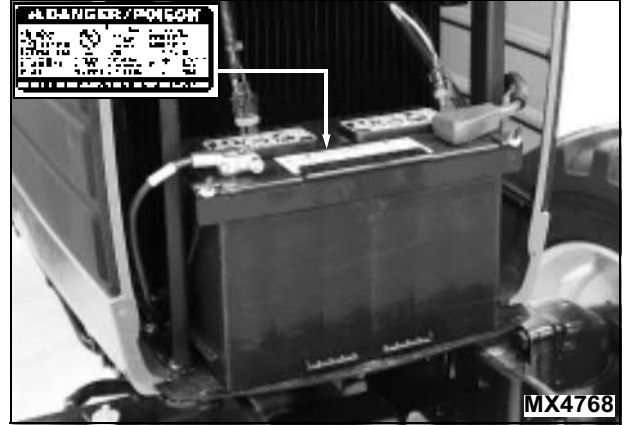

- No sparks, flames, smoking.
- Sulfuric acid can cause blindness or severe burns.
- Flush eyes immediately with water.
- Get medical help fast.
- Keep out of reach of children.
- Do not tip.
- Keep vent caps tight and level.

DANGER

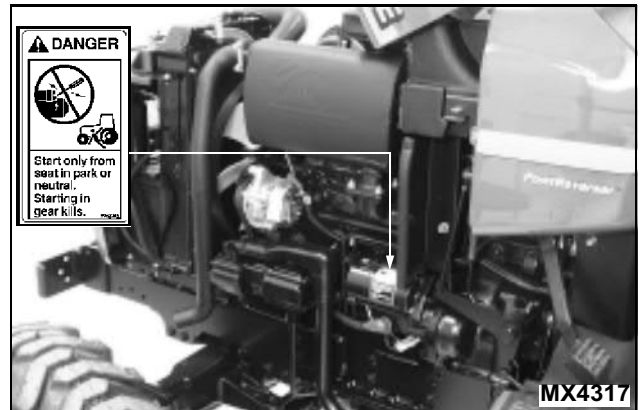

Picture Note: Remove LEFT side panel to locate safety label.

- Start only from seat, in park or neutral.
- Starting in gear kills.

SAFETY

CAUTION: UNEXPECTED HITCH MOVEMENT



Picture Note: Label installed on tractors equipped with optional draft sensing kit.

Move draft control lever (2) to “MAX” position before leaving seat.

- The owner/user can prevent accidents with proper use of the machine. The owner/user is responsible for accidents or injuries occurring to themselves, other people or property.
- Do not allow operation of the machine by untrained persons.
- Read the operator manual and study the safety and operation sections before operating the machine.
- If the operator of the machine cannot read or understand this manual, the machine owner is responsible to explain this material to the operator. This publication is available in other languages.
- Operate the machine in an open, unobstructed area under the direction of an experienced operator.
- Learn the use of all controls.
- Operator practice is required to learn the moving, stopping, turning and other operating characteristics of the machine.

WARNING



1. COUPLE BRAKE PEDALS TOGETHER FOR ROAD TRAVEL OR SETTING PARK BRAKE.
2. SET BRAKES SECURELY BEFORE DISMOUNTING.
3. TO SET BRAKES, FULLY DEPRESS BRAKE PEDALS WHILE PULLING BRAKE KNOB TOWARDS YOU.
4. TO DISENGAGE BRAKES, PUSH KNOB FULLY FORWARD, DEPRESS BRAKE PEDAL(S) TO RELEASE LOCK.

Operator Training Required

- The owner of the machine is responsible for training the users of the machine.

Operating Safely

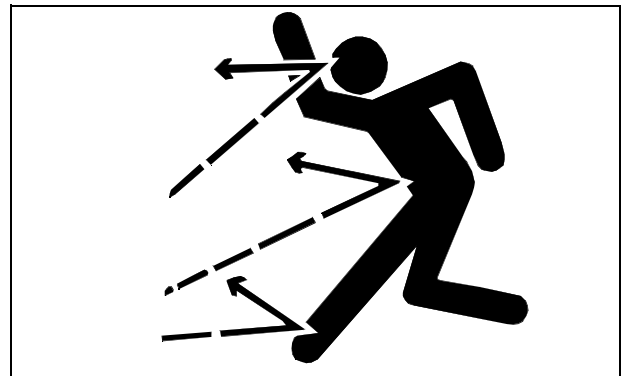

- Inspect machine before you operate. Be sure hardware is tight. Repair or replace damaged, badly worn, or missing parts. Be sure guards and shields are in good condition and fastened in place. Make any necessary adjustments before you operate.
- Check before each use that operator presence controls are functioning correctly. Test safety systems. Do not operate unless they are functioning correctly.
- Do not change the engine governor setting or overspeed the engine.
- Check brake action before you operate. Adjust or service brakes as necessary.
- Stop machine if anyone enters the area.
- If you hit an object, stop and inspect the machine. Make repairs before you operate. Keep machine and attachments properly maintained and in good working order.

SAFETY

- Do not leave machine unattended when it is running.
- Only operate during daylight or with good artificial light.
- Slow down and be careful of traffic when operating near or crossing roadways. Make sure to stop blades before crossing roads or sidewalks. Use care when approaching blind corners, shrubs, trees, or other objects that may obscure vision.
- Be aware of the mower discharge direction and make sure that no one is in the path of the discharge direction.
- Do not wear radio or music headphones while operating the machine. Safe operation requires your full attention.

Use Seat Belt Properly

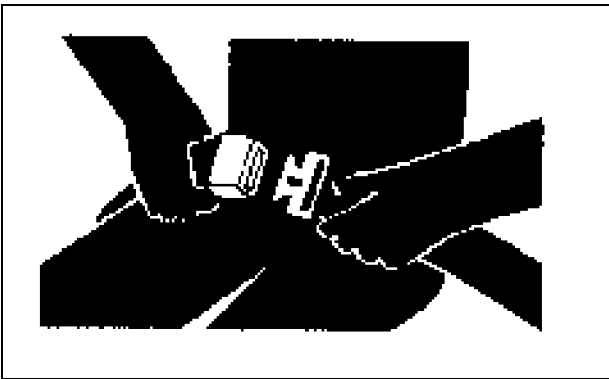

Use a seat belt when you operate with a Roll-Over Protective Structure (ROPS) to minimize chance of injury from an accident, such as an overturn.

Do not use a seat belt if operating without a ROPS.

Rotating Blades are Dangerous

HELP PREVENT SERIOUS OR FATAL ACCIDENTS:

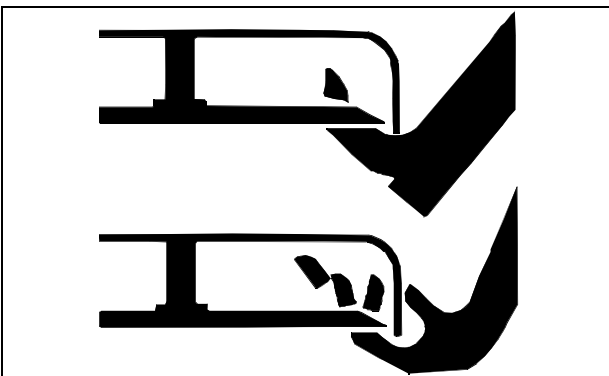

- Rotating blades can cut off arms and legs.

- Keep hands, feet and clothing away from mower deck when engine is running.
- Be alert at all times, drive forward carefully. People, especially children can move quickly into the mowing area before you know it.
- Before backing up, shut off PTO and look down and behind the machine carefully, especially for children.
- Do not mow in reverse.
- Shut off blades when you are not mowing.
- Do not operate machine if you are under the influence of drugs or alcohol.
- Park machine safely before inspecting or unplugging mower or bagger.

PROTECT CHILDREN:

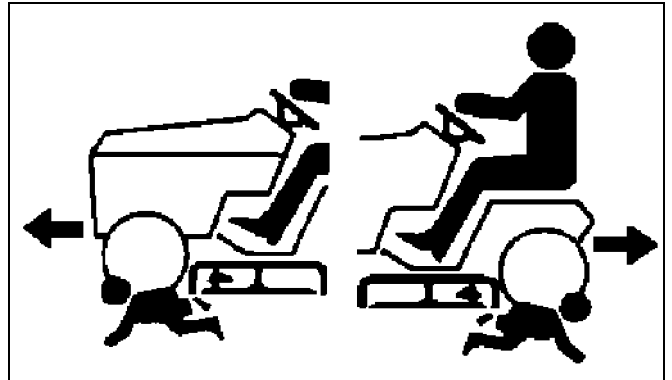

- Never assume that children will remain where you last saw them. Children are attracted to mowing activity, stay alert to the presence of children.
- Keep children indoors when you are mowing. Turn the machine off if a child enters the mowing area.
- Use extra care when you come to blind corners, shrubs, trees, or other objects that may block your vision.
- Do not let children or an untrained person operate the machine.
- Do not carry or let children ride on any attachment or machine even with the blades off. Do not tow children in a cart or trailer.

SAFETY

Checking Mowing Area

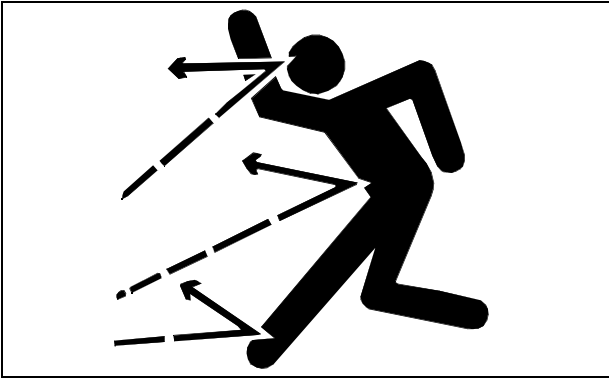

- Clear mowing area of objects that might be thrown. Keep people and pets out of mowing area.
- Study mowing area. Set up a safe mowing pattern. Do not mow where traction or stability is doubtful.
- Test drive area with mower lowered but not running. Slow down when you travel over rough ground.

Keep Riders Off



- Only allow the operator on the machine. Keep riders off.
- Riders on the machine or attachment may be struck by foreign objects or thrown off the machine causing serious injury.
- Riders obstruct the operator's view resulting in the machine being operated in an unsafe manner.

Avoid Tipping

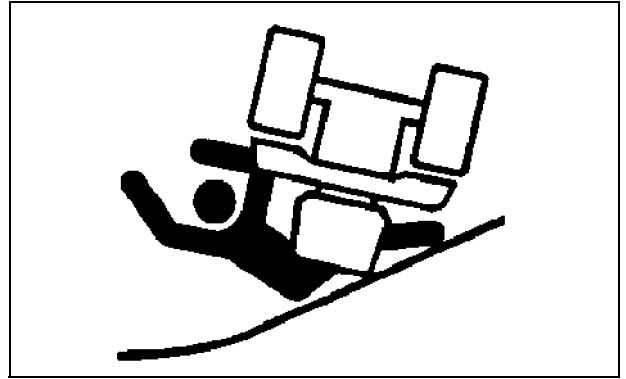

- Slopes are a major factor related to loss-of-control and tip-over accidents, which can result in severe injury or death. If you cannot back up the slope or if you feel uneasy on it, do not mow it.
- Do not drive where machine could slip or tip.
- Stay alert for holes and other hidden hazards in the terrain.
- Keep away from drop-offs, ditches and embankments.
- Slow down before you make a sharp turn or operate on a slope. Choose a low gear so that you will not have to stop or shift while on the slope.
- Limit loads to those you can safely control. Use only approved hitches when pulling loads or using heavy equipment. Use counterweights or wheel weights as required in this manual or your attachment manual.
- Use wheel weights for added stability when operating on slopes or using rear mounted attachments.
- Drive up and down a hill - not across. Turn slowly and turn downhill. Do not shift to neutral and coast downhill.
- Do not stop when going up hill or down hill. If machine stops going up hill, disengage mower blades and back down slowly.
- Mowing when grass is wet can cause reduced traction and sliding.
- Do not try to stabilize the machine by putting your foot on the ground.

SAFETY

Stay Clear of Rotating Drivelines



Entanglement in rotating driveline can cause serious injury or death.

- Wear close fitting clothing.
- STOP the engine and be sure PTO driveline is stopped before getting near it.

Checking Wheel Bolts

- A serious accident could occur causing serious injury if wheel bolts are not tight.
- Check wheel bolt tightness often during the first 100 hours of operation.
- Wheel hardware must be tightened to specified torque using the proper procedure anytime it is loosened.

Wear Appropriate Clothing

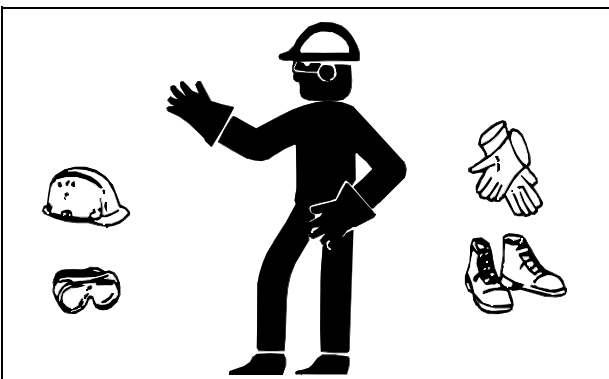

- Wear close fitting clothing and safety equipment appropriate for the job.
- Always wear safety goggles or safety glasses with side shields when operating the mower.
- Wear a suitable protective device such as earplugs. Loud noise can cause impairment or loss of hearing.

- Do not wear radio or music headphones. Safe service and operation requires your full attention.

Parking Safely

1. Stop machine on a level surface, not on a slope.
2. Disengage PTO.
3. Lower attachments to the ground.
4. Lock park brake.
5. Stop engine.
6. Remove key.
7. Before you leave the operator's station, wait for engine and all moving parts to stop.

Driving Safely on Public Roads

Avoid personal injury or death resulting from a collision with another vehicle on public roads:

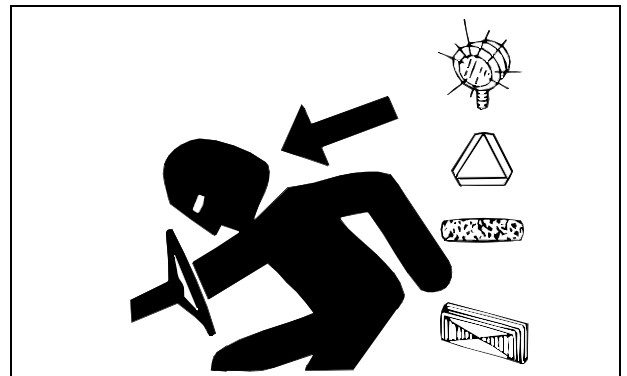

- Use safety lights and devices. Slow moving machines when driven on public roads are hard to see, especially at night.
- Use extra care when loading or unloading the machine into a trailer or truck.
- Whenever driving on public roads, use flashing warning lights and turn signals according to local regulations. Extra flashing warning lights may need to be installed.

SAFETY

Practice Safe Maintenance



- Understand service procedure before doing work. Keep area clean and dry.
- Never lubricate, service, or adjust machine while it is moving. Keep safety devices in place and in working condition. Keep hardware tight.
- Keep hands, feet, clothing, jewelry, and long hair away from any moving parts, to prevent them from getting caught.
- Lower attachments to the ground before servicing machine. Disengage all power and stop the engine. Lock park brake and remove the key. Let machine cool.
- Disconnect battery or remove spark plug wire before making any repairs.
- Before servicing the machine, carefully release pressure from any components with stored energy, such as hydraulic components.
- Keep all nuts and bolts tightened, especially blade attachment bolts.
- Securely support any machine elements that must be raised for service work.
- Never run engine unless park brake is locked.
- Keep all parts in good condition and properly installed. Fix damage immediately. Replace worn or broken parts. Replace all worn or damaged safety and instruction decals.
- To prevent fires, remove any buildup of grease, oil, or debris from the machine, especially the engine compartment.
- Charge batteries in an open, well-ventilated area, away from sparks. Unplug battery charger before connecting or disconnecting from the battery. Use insulated tools.
- Do not modify machine or safety devices. Unauthorized modifications may impair its function and safety.
- Do not wear radio or music headphones while servicing the machine. Safe service requires your full attention.

Prevent Fires

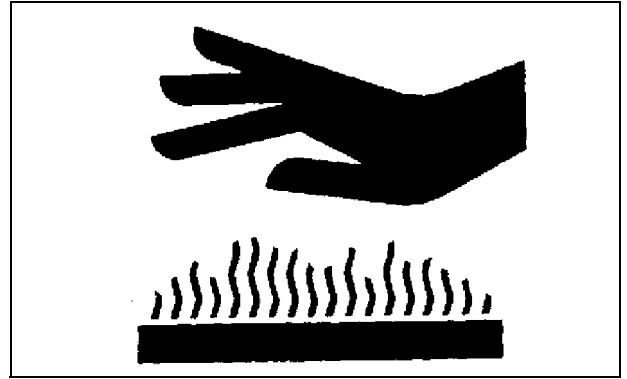

- Never remove fuel cap, or add fuel with engine running or hot. Allow engine to cool for several minutes.
- Never store equipment with fuel in the tank inside a building where fumes may reach an open flame or spark.
- Allow engine to cool before storing in any enclosure.
- To reduce fire hazard, keep engine free of grass, leaves, or excessive grease.

Avoid High Pressure Fluids



- Hydraulic hoses and lines can fail due to physical damage, kinks, age, and exposure. Check hoses and lines regularly. Replace damaged hoses and lines.
- Hydraulic fluid connections can loosen due to physical damage and vibration. Check connections regularly. Tighten loose connections.
- Escaping fluid under pressure can penetrate the skin causing serious injury. Avoid the hazard by relieving pressure before disconnecting hydraulic or other lines. Tighten all connections before applying pressure.
- Search for leaks with a piece of cardboard. Protect hands and body from high pressure fluids.
- If an accident occurs, see a doctor immediately. Any fluid injected into the skin must be surgically removed within a few hours or gangrene may result. Doctors

SAFETY

unfamiliar with this type of injury should reference a knowledgeable medical source. Such information is available from Deere & Company Medical Department in Moline, Illinois, U.S.A. Information may be obtained in the United States and Canada only by calling 1-800-822-8262.

Tire Safety

Explosive separation of a tire and rim parts can cause serious injury or death:

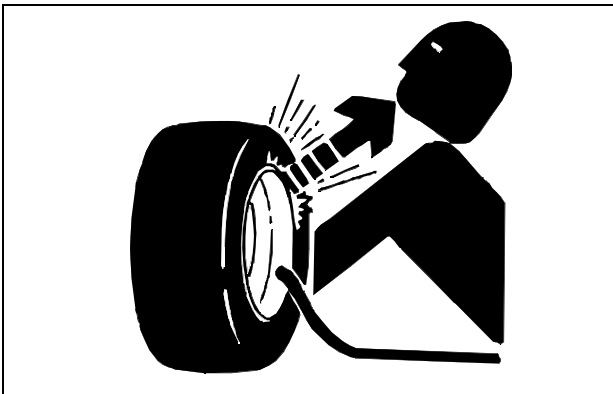

- Do not attempt to mount a tire without the proper equipment and experience to perform the job.
- Always maintain the correct tire pressure. Do not inflate the tires above the recommended pressure. Never weld or heat a wheel and tire assembly. The heat can cause an increase in air pressure resulting in a tire explosion. Welding can structurally weaken or deform the wheel.
- When inflating tires, use a clip-on chuck and extension hose long enough to allow you to stand to one side and NOT in front of or over the tire assembly.
- Check tires for low pressure, cuts, bubbles, damaged rims or missing lug bolts and nuts.

Handling Fuel Safely

Fuel and fuel vapors are highly flammable:

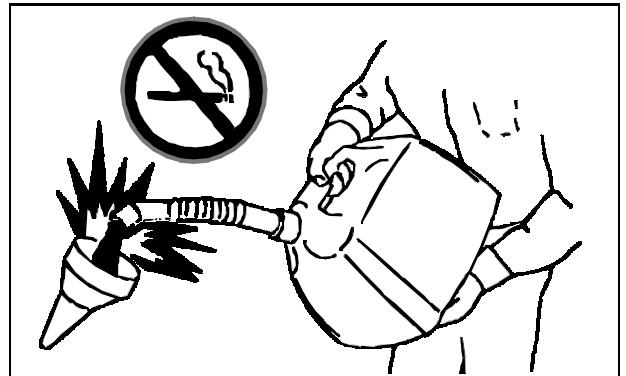

- Do not refuel machine while you smoke, when machine is near an open flame or sparks, or when engine is running. Stop engine and allow to cool before filling.
- Never remove the fuel cap or add fuel with the engine running.
- Never fill fuel tank or drain fuel from a machine in an enclosed area. Fill fuel tank outdoors.
- Prevent fires. Clean up spilled fuel immediately.
- Do not store machine with fuel in tank in a building where fumes may reach an open flame or spark.
- Prevent fire and explosion caused by static electric discharge. Use only non-metal, portable fuel containers approved by the Underwriter's Laboratory (U.L.) or the American Society for Testing & Materials (ASTM). If using a funnel, make sure it is plastic and has no screen or filter.



- Static electric discharge can ignite gasoline vapors in an ungrounded fuel container. Remove the fuel container from the bed of a vehicle or the trunk of a car and place on the ground away from the vehicle before filling. Keep nozzle in contact with container opening while filling.
- When practical, remove equipment from trailers or truck

SAFETY

beds and refuel them on the ground. If this is not possible, use a portable, plastic fuel container to refuel equipment on a truck bed or trailer.

- For gasoline engines, do not use gas with methanol. Methanol is harmful to your health and to the environment.

Handling Waste Product and Chemicals

Waste products, such as, used oil, fuel, coolant, brake fluid, and batteries, can harm the environment and people:

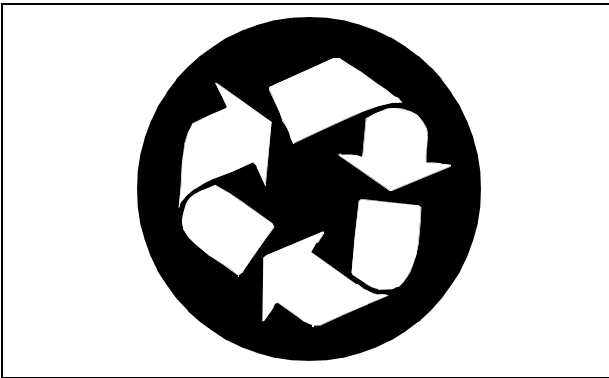

- DO NOT use beverage containers for waste fluids - someone may drink from them.
- See your local Recycling Center or John Deere dealer to learn how to recycle or get rid of waste products.
- A Material Safety Data Sheet (MSDS) provides specific details on chemical products: physical and health hazards, safety procedures, and emergency response techniques. The seller of the chemical products used with your machine is responsible for providing the MSDS for that product.

OPERATING

Daily Operating Checklist

- Test safety systems.
- Check tire pressure.
- Check fuel level.
- Check engine oil level.
- Check transmission oil level.
- Check coolant level on liquid cooled engine.
- Remove grass and debris from machine.
- Clean air intake screen.
- Check area below machine for leaks.

Avoid Damage to Plastic and Painted Surfaces

- Do not wipe plastic parts unless rinsed first.
- Insect repellent spray may damage plastic and painted surfaces. Do not spray insect repellent near machine.
- Be careful not to spill fuel on machine. Fuel may damage surface. Wipe up spilled fuel immediately.

Operator Station Controls

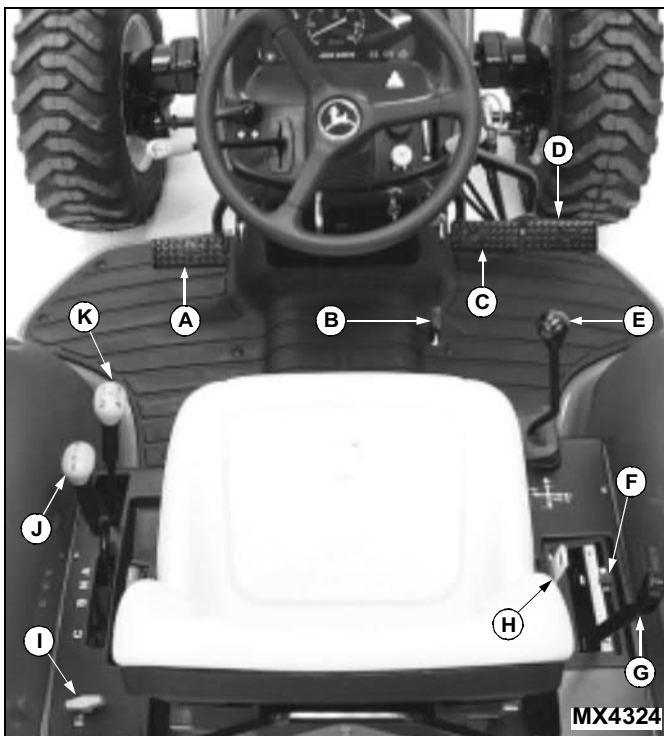

Picture Note: PowrReverser Model

- A - Clutch Pedal
- B - Engine Speed Foot Throttle
- C - Left Turn Brake Pedal
- D - Right Turn Brake Pedal
- E - Selective Control Valve (SCV) Lever
- F - Rockshaft Adjustable Depth Stop Knob
- G - Rockshaft Control Lever
- H - Seat Belt
- I - MFWD Control Handle
- J - Transmission Range Shift Lever
- K - Transmission Gear Shift Lever

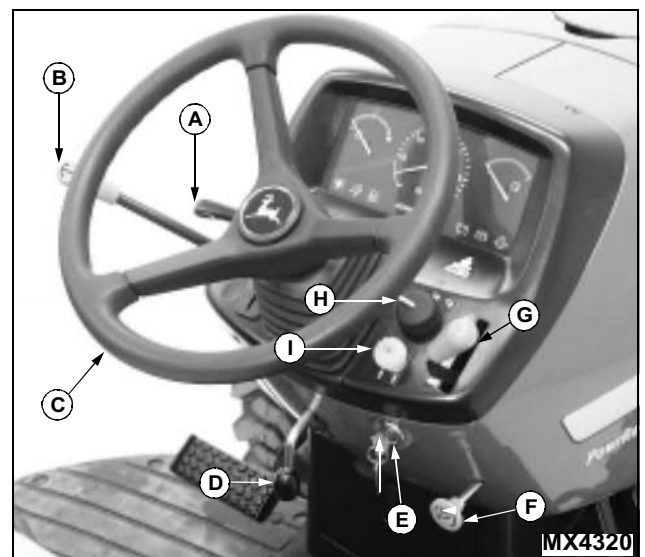

Picture Note: PowrReverser Model

- A - Turn Signal Lever
- B - Reverser Lever (PowrReverser Models)
- C - Steering Wheel
- D - Tilt Steering Control Lever
- E - Ignition Key Switch
- F - Park Brake Lock
- G - Engine Speed Hand Throttle
- H - Light Control Switch
- I - PTO Control Knob

OPERATING

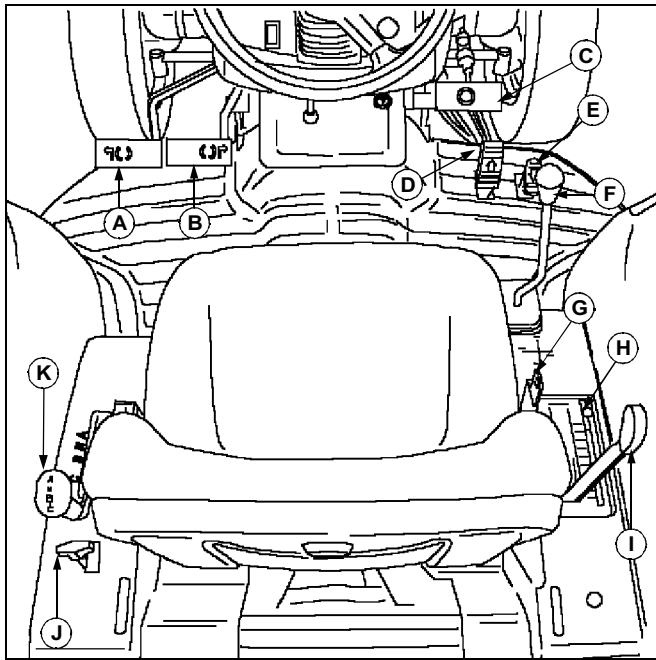

Picture Note: Hydrostatic Model

- A - Left Turn Brake Pedal
- B - Right Turn Brake Pedal
- C - Master Brake Pedal
- D - Forward Travel Pedal
- E - Reverse Travel Pedal
- F - Selective Control Valve (SCV) Lever
- G - Seat Belt
- H - Rockshaft Adjustable Depth Stop Knob
- I - Rockshaft Control Lever
- J - MFWD Control Handle
- K - Transmission Range Shift Lever

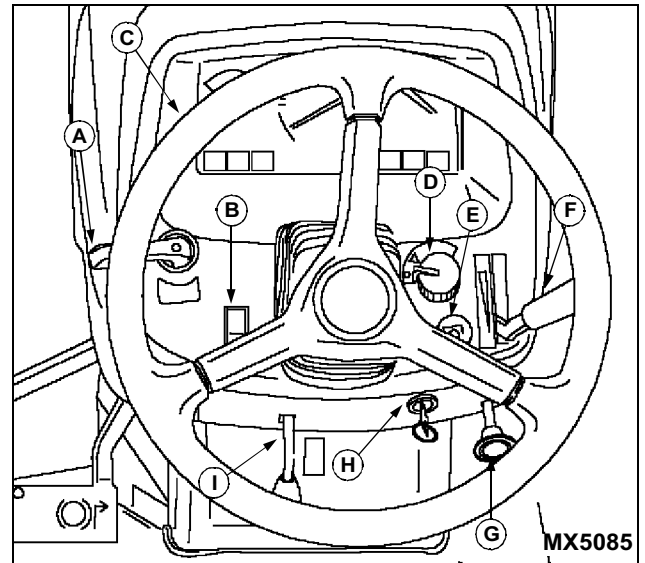

Picture Note: Hydrostatic Model

- A - Turn Signal Lever
- B - Cruise Control Switch
- C - Steering Wheel
- D - Light Control Switch
- E - PTO Control Knob
- F - Engine Speed Hand Throttle
- G - Park Brake Lock
- H - Ignition Key Switch
- I - Tilt Steering Control Lever

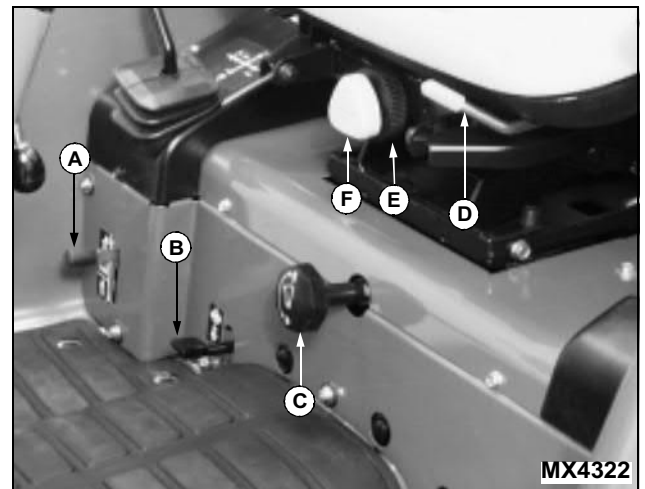

- A - Selective Control Valve (SCV) Lock Lever
- B - Differential Lock Lever
- C - Rockshaft Rate-of-Drop Control Knob
- D - Operator Seat Adjustment Lever
- E - Operator Seat Height Adjustment Knob
- F - Operator Seat Suspension Adjustment Knob

OPERATING

3-Point Hitch

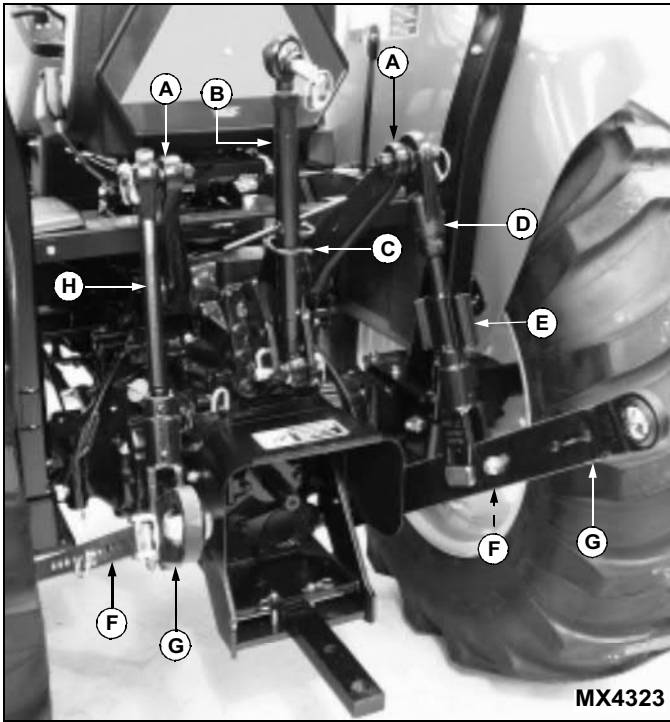

- A - Lift Arms
- B - Center Link
- C - Center Link Storage Hook
- D - Adjustable Lift Link
- E - Lift Link Turn Handle
- F - Sway Link
- G - Draft Link
- H - Non-Adjustable Lift Link

- B - Turn Signal/ Warning Flasher Lights
- C - Tachometer
- D - Coolant Temperature Gauge
- E - Oil Pressure Light
- F - Park Brake Light
- G - Alternator/Battery Charging Light
- H - Hour Meter
- I - Cold Start Indicator Light
- J - Cruise Control Indicator Light (Operational on Hydrostatic Models Only)
- K - PTO Engaged Light

Hood Controls

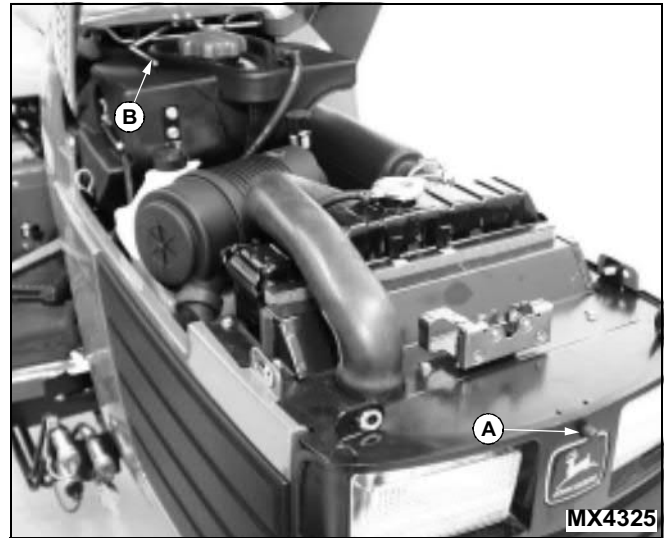

- A - Hood Release Button
- B - Hood Support Latch

Instrument Panel

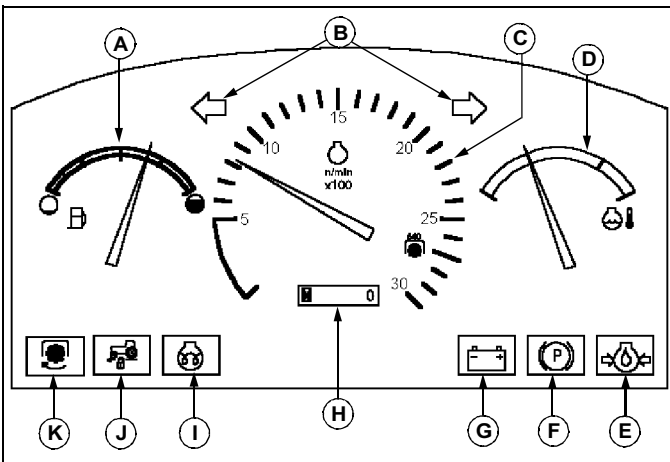

- A - Fuel Gauge

Using Step



Step (A) is located on the left side of tractor. Use step for entering and exiting the operator station.

OPERATING

Adjusting Operator Seat

Before starting engine to operate tractor, adjust operator seat position, height and suspension.

Adjusting Seat Position

1. Sit on the operator seat.

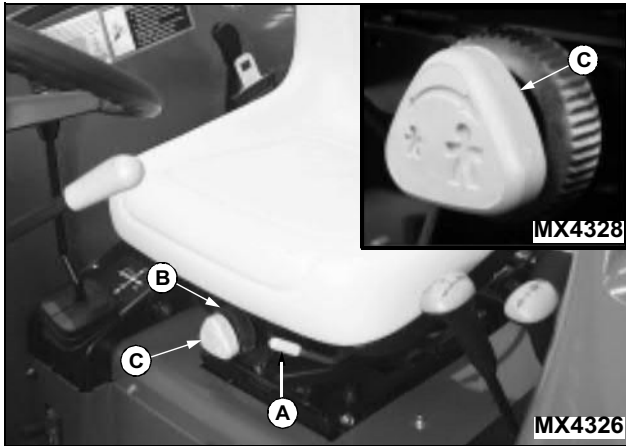

2. Pull up on seat lever (A).
3. Slide seat forward or rearward to desired position.
4. Release lever to lock seat in position. Make sure all controls can be easily accessed.

Adjusting Seat Height

1. Turn height adjustment knob (B) clockwise to raise operator seat.
2. Turn height adjustment knob (B) counterclockwise to lower operator seat.

Adjusting Seat Suspension

Adjust seat suspension to accommodate the weight of the operator. Operator size indications are molded into the suspension knob.

1. Hold height adjustment knob (B) with one hand.
2. Turn suspension knob (C) clockwise to increase seat spring tension and provide a firmer ride.
3. Turn seat suspension knob (C) counterclockwise to decrease seat spring tension and provide a softer ride.

Using Seat Belt



CAUTION: Avoid injury!

- Use a seat belt when you operate with a Roll-Over Protective Structure (ROPS) to minimize chance of injury from an accident, such as an overturn.
- Do not use a seat belt if operating without a ROPS, or with an optional folding ROPS in the folded position.

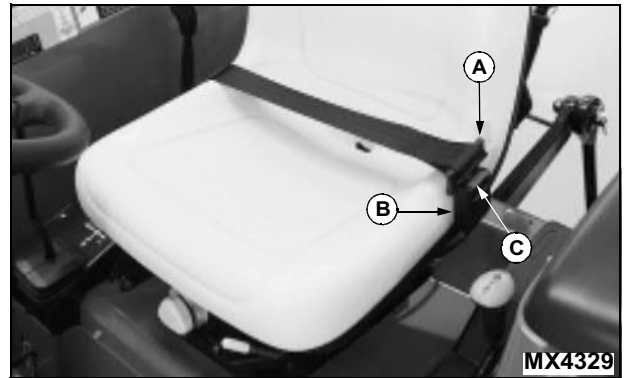

Fasten Belt

1. Pull belt end (A) across operator lap.
2. Install tab into buckle (B).
 - A “click” will be heard when the tab locks into the buckle.

Release Belt

1. Press red button (C) to release seat belt allowing the belt to automatically retract.

Adjusting Tilt Steering Wheel



CAUTION: Avoid injury! Attempting to adjust the steering wheel while the machine is moving may cause the operator to lose control of the machine.

- Stop the machine before adjusting the steering wheel.
- Lock the steering wheel in position before driving the machine.

1. Park machine safely. (See Parking Safely in the SAFETY section.)



Suggest:

If the above button click is invalid.

Please download this document

first, and then click the above link

to download the complete manual.

Thank you so much for reading

OPERATING

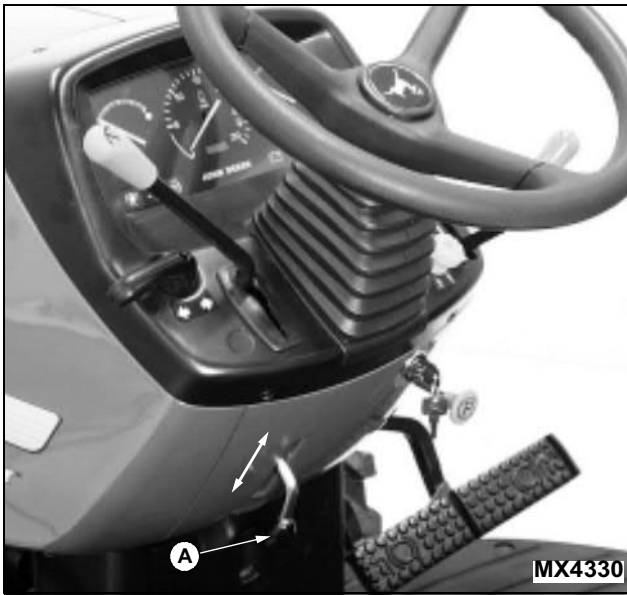

Picture Note: PowrReverser model shown.

2. Pull up on tilt steering wheel lock release lever (A).
3. Adjust steering wheel to desired position.
4. Push down on lever (A) to lock steering wheel in position.

Using Light Switch



CAUTION: Avoid injury! Do not operate on roads with light switch in the field position. Rear work lights may blind or confuse operators of on-coming vehicles.

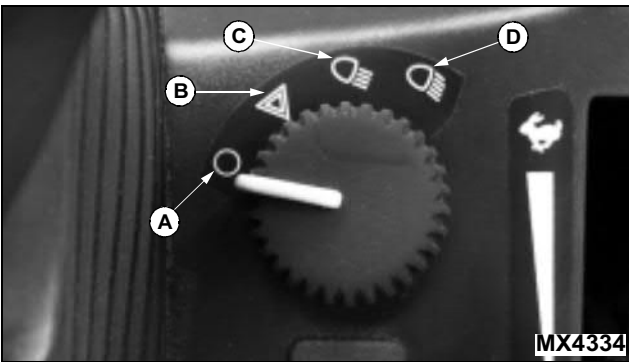

- A - All lights off.
- B - Warning flasher lights on.
- C - Road Position: headlights, taillights, and warning flasher lights on.
- D - Field Position: headlights, taillights, and optional

working lights on.

Using Key Switch

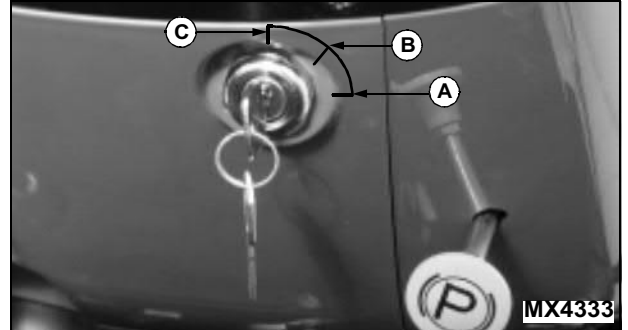

A - Start Position - Rotate the key to the start position to start the engine. Release the key after the engine has started and it will automatically return to the run position. The engine will continue to run.

B - Run Position - Rotate the key to the run position and the engine oil pressure light and battery charging lights should illuminate. You will also hear a clicking noise when the engine fuel shut-off solenoid engages.

C - Off Position - With the key in the off position, all switched power is off, and the engine should not run.

IMPORTANT: Avoid damage! There is an accessory key switch position to the left of the key switch off position. Do not move the key switch to this position. The battery could be drained.

Using Instrument Panel

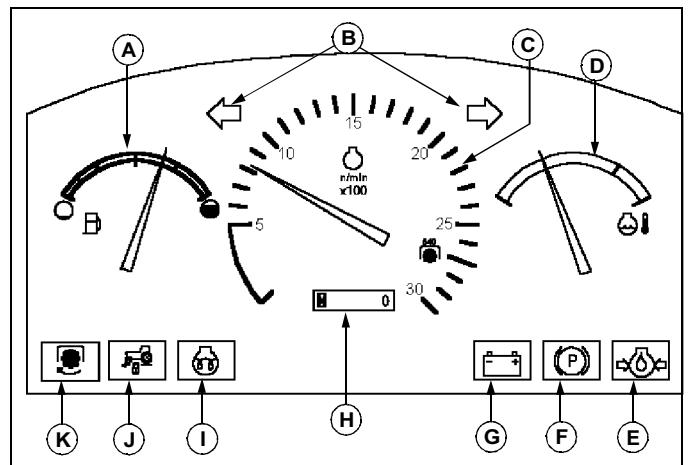

A-Fuel Gauge: Shows approximately how much fuel is in the fuel tank. Includes full marker, half-full marker and empty marker.

<https://www.ebooklibonline.com>

Hello dear friend!

Thank you very much for reading.

Enter the link into your browser.

The full manual is available for immediate download.

<https://www.ebooklibonline.com>