

3300 COMBINE



OPERATORS MANUAL

3300
COMBINE

OMH84016 L1 English

JOHN DEERE HARVESTER WORKS
OMH84016 L1

LITHO IN THE U.S.A.
ENGLISH

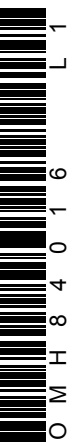



To the Purchaser

This new combine was carefully designed and manufactured to give years of dependable service. To keep it running efficiently, read the instructions in this operator's manual. Each section is clearly identified so you can easily find the information you need—whether it is operation, lubrication, or service. Read the Table of Contents to learn where each section is located. Use the alphabetical index for fast reference.

This operator's manual covers the feeder house and separator areas of the combine. For platform and corn head information, see the separate operator's manuals furnished with this equipment.

In addition to the equipment furnished with your combine, attachments are available to help you do a better job in special crop conditions. These are described in the attachments section of this manual and can be purchased from your John Deere dealer.

"Right-hand" and "left-hand" sides are determined by facing in the direction the combine will travel when

in use. The radiator end of the engine is referred to as the "front," the flywheel end as the "rear."

 This safety alert symbol identifies important safety messages in this manual. When you see this symbol, be alert to the possibility of personal injury and carefully read the message that follows.

Record your combine serial numbers in the space provided on page 133. Your dealer needs this information to give you prompt, efficient service when you order parts or attachments. If your combine requires replacement parts, go to your John Deere dealer where you can obtain Genuine John Deere parts—accept no substitutes.

The warranty on this combine appears on your copy of the purchase order which you should have received from your dealer when you purchased the combine.

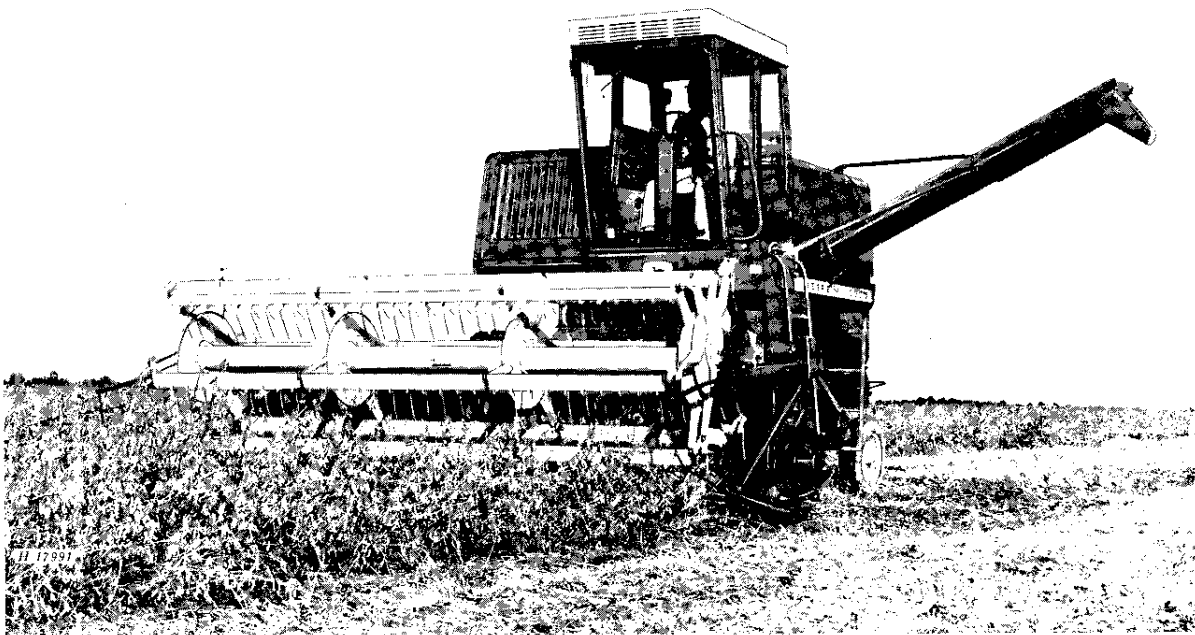



Contents

	Page
Controls and instruments	2-3
Operation	4-30
Safety suggestions	31
Fuels and lubricants	32-33
Lubrication and periodic service	34-44
Service	45-106
Trouble shooting	107-119
Storage	120-122
Attachments	123-129
Specifications	130-134
Index	135-138

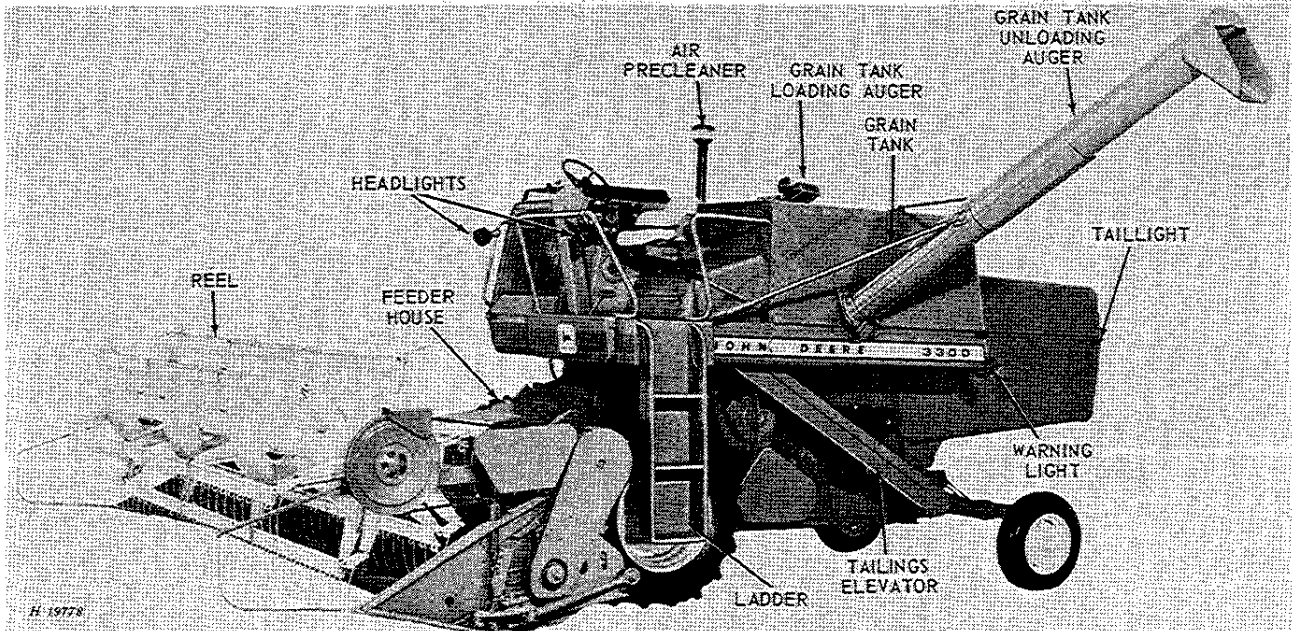

John Deere 3300 Combine

<https://www.ebooklibonline.com>

Hello dear friend!

Thank you very much for reading.

Enter the link into your browser.

The full manual is available for immediate download.

<https://www.ebooklibonline.com>



Controls and Instruments

This section illustrates all controls and instruments necessary for successful field operation. For an explanation of each control and instrument, refer to the page reference given.

Before attempting to operate your new combine, become familiar with the location and purpose of its controls and instruments. Study these pages carefully, regardless of your previous combine experience.

The control levers and knobs have different colors and shapes. These have been designed to help you quickly locate the controls while operating the combine. Colors on controls indicate:

RED Combine movement controls (Throttle, Gearshift Lever, Selective Ground Speed Control)

OPERATOR'S PLATFORM

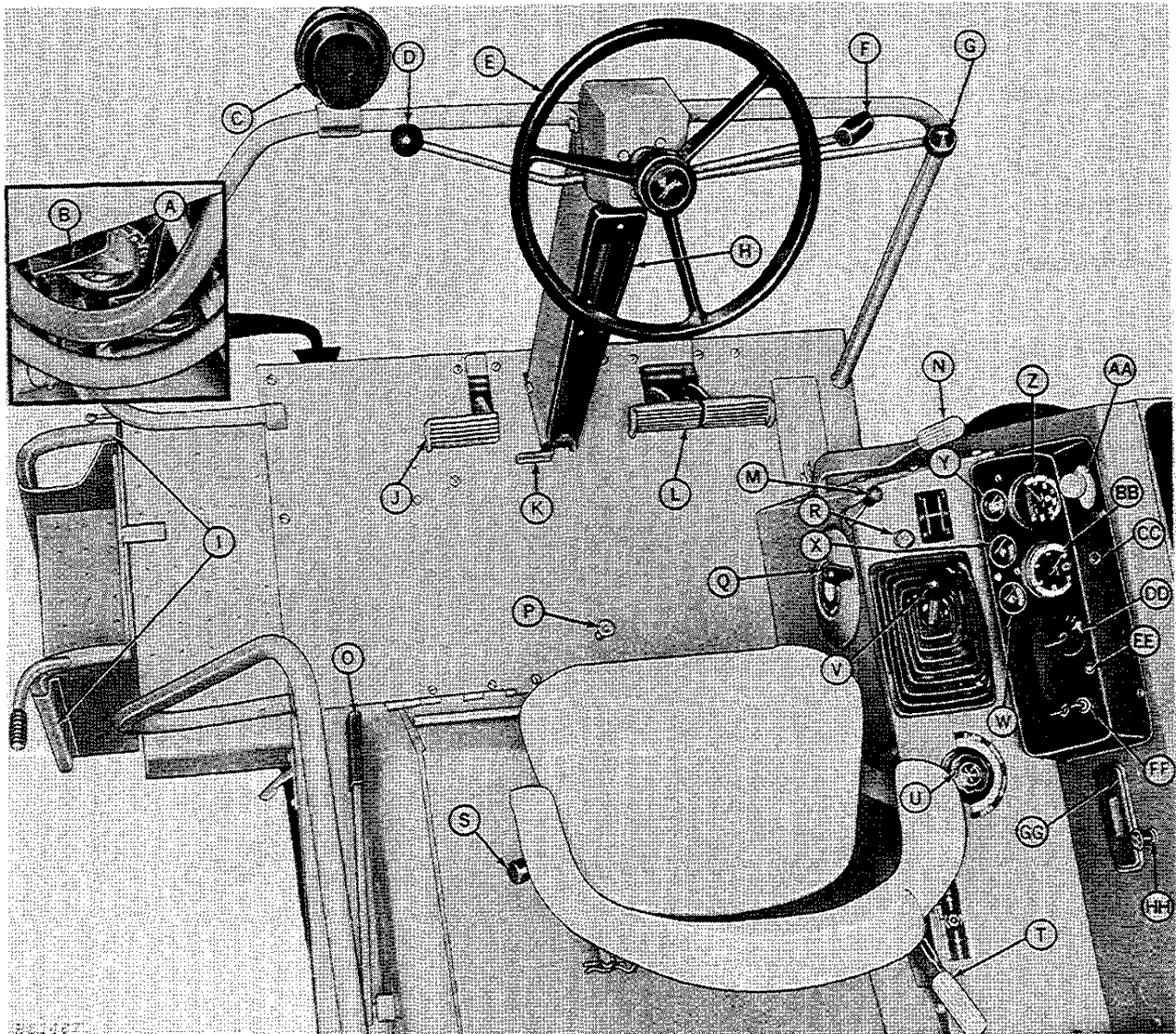

YELLOW.... Auxiliary Power Controls (Separator Control Lever, Cylinder Speed Ratchet Control, Platform or Corn Head Electromagnetic Clutch Switch)

BLACK.... Miscellaneous Function Controls (Platform or Corn Head Height Control, Hydraulic Lift Reel Control, etc.)

ENGINE - AIR INTAKE

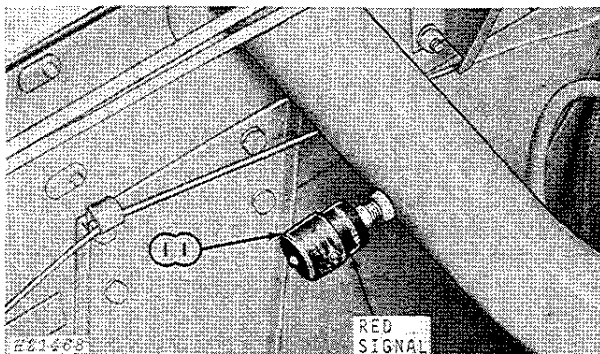

FEEDER HOUSE

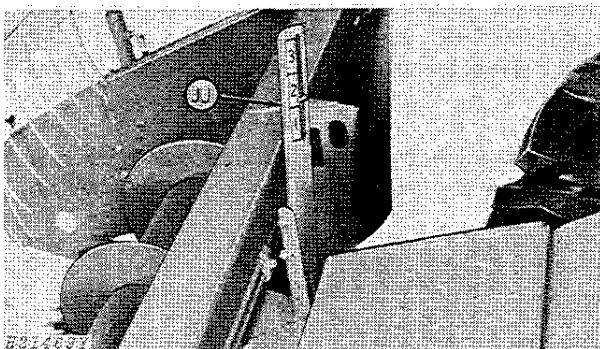

SEPARATOR

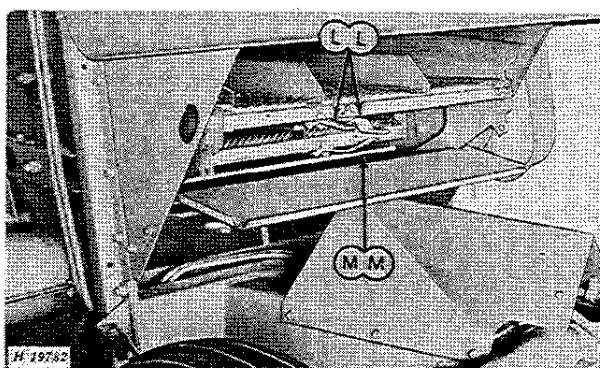
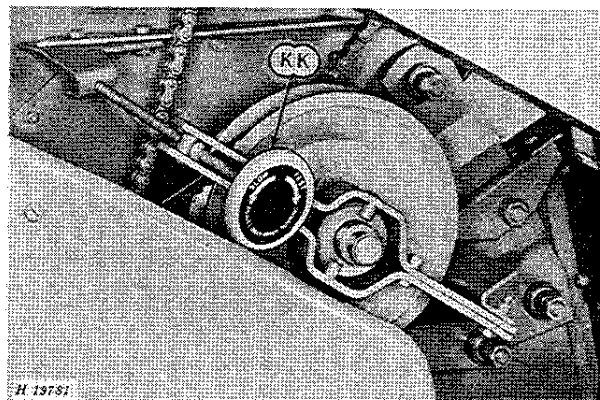

	Page
A - Truck Signal Horns	25
B - Coolant Temperature Warning Horn or Straw Walker Warning Horn (Attachment)	7, 128
C - Headlight	25
D - Hydraulic Lift Reel Control (Optional)	124
E - Steering Wheel	22
F - Selective Ground Speed Control	22
G - Platform or Corn Head Height Control Lever	12
H - Ground Speed Indicator (Attachment)	22
I - Pivoting Ladder	10
J - Clutch Pedal	23
K - Steering Column Control Pedal	10
L - Brake Pedals	23
M - Throttle	6
N - Separator Control Lever	15
O - Grain Tank Unloading Auger Lever	21
P - Parking Brake Lock Button	22
Q - Concave Opening Control Wheel	16

	Page
R - Choke—Gasoline only	6
S - Operator's Seat Control Lever	9
T - Cylinder Speed Control Ratchet	15
U - Hydrostatic Drive Reel Control or Hydrostatic Drive Belt Pickup (Optional)	123, 124
V - Gearshift Lever	22
W - Coolant Temperature Gauge	6
X - Engine Oil Pressure Gauge	7
Y - Fuel Gauge	7
Z - Engine Tach-Hour Meter	7
AA - Platform or Corn Head Electromagnetic Clutch Switch (Optional)	12
BB - Cylinder Speed Tachometer	15
CC - Alternator Indicator Light	6
DD - Light Switch	25
EE - Horn Button	25
FF - Key Switch	6
GG - Ash Tray	25
HH - Cigarette Lighter	25
II - Air Restriction Indicator (Attachment)	7
JJ - Platform Float Spring Indicator (Attachment)	125
KK - Fan Speed Control Wheel	18
LL - Chaffer Opening Control Levers	19
MM - Sieve Opening Control Lever	19



Operation

COMBINE AND ENGINE BREAK-IN

Follow the lubrication instructions closely. See pages 34 to 44.

Check coolant level in radiator and add coolant if necessary. Do not use water containing alkali. If combine is being operated in temperatures below 32°F., refer to "Cold Weather Operation," page 5.

To promote good ring seating and to prevent cylinder wall glazing, put the engine to work as soon as possible. Do not overload.

AFTER 1 HOUR.

Check torque on drive wheel bolts. Tighten bolts to 180 ft-lbs torque.

AFTER 5 HOURS

Check all V-belts for initial stretch. Tighten if necessary. Continue to check V-belts every few hours for the first 50 hours.

AFTER 20 HOURS

Drain oil from hydraulic unit reservoir. Replace the oil filter and fill the reservoir with correct oil as shown on page 33. Thereafter, drain and replace oil and oil filter element every 500 hours of operation.

AFTER 100 HOURS

During break-in, if oil consumption warrants, add oil as specified on page 34.

After the first 100 hours of operation, drain oil from crankcase, replace oil filter, and fill crankcase to proper level with John Deere Torq-Gard engine oil or its equivalent as specified in lubricants chart on page 33.

Thereafter change the oil and filter every 100 hours of operation or every season, whichever occurs first.

COLD WEATHER OPERATION

FUEL SYSTEM

Use winter-grade fuel. Fill the fuel tank at the end of the day's run to prevent moisture from condensing in the fuel tank.

COOLING SYSTEM

Drain, flush, and fill cooling system with a recognized brand of radiator sealer and antifreeze solution. Use a permanent-type (ethylene glycol) antifreeze solution containing rust inhibitors. This type of antifreeze is resistant to evaporation when heated. Do not use antifreeze which contains stop leak additives.

Quarts of Ethylene Glycol Required at Lowest Expected Temperature					
+20°F.	+10°F.	0°F.	-10°F.	-20°F.	-34°F.
4	7	9	11	12	14

After filling, check system for leaks.

BATTERY

When the temperature drops below freezing, be sure battery is fully charged. A badly discharged battery freezes more quickly than one that is well charged. For example, a battery with a specific gravity reading of 1.175 (discharged) will freeze at 4°F., and a battery with specific gravity reading 1.300 (fully charged) will not freeze until the temperature reaches -65°F.

In freezing weather, do not add water to the battery unless engine is going to be run. Water will freeze as it will not mix with the electrolyte until the alternator passes a charging current through the battery.

IMPORTANT: If booster battery is required, see instructions on page 86.

COLD WEATHER STARTING AID

Diesel engines are equipped with an ether starting fluid adapter which injects atomized fluid into the engine air intake system. Normally ether is used for starting at temperatures below 32° F. Pressurized cans of starting fluid are available from your John Deere dealer.

To use the starting fluid, remove the safety cap and plastic spray button from the can. Remove the cap from the adapter and position the can in the adapter.



To inject starting fluid, push in on the can.

IMPORTANT: To avoid damage, turn engine with starter one or two revolutions before injecting starting fluid. Inject starting fluid only while the engine is turning.

Relax pressure on the can between "shots" of starting fluid. Stop injecting fluid after the engine starts. If the engine begins to die during the first few minutes of operation, inject another "shot" of fluid. When the engine is operating satisfactorily, remove the can from the adapter and replace the safety cap on the can.

Install the cap on the adapter when it is not in use to prevent dust from being drawn into the engine.

CAUTION: Ether starting fluid is highly flammable. Store starting fluid cans where they will not be subject to extreme cold or warm temperatures. For best results, store fluid at room temperature.

HOT WEATHER OPERATION

Protect the combine engine cooling system by using Summer Engine Coolant Conditioner.

The Summer Engine Coolant Conditioner is available under Part No. T19566, and may be purchased from your John Deere dealer.

To install the Summer Engine Coolant Conditioner, perform the following:

Drain and flush cooling system and add two 32-ounce cans of Summer Engine Coolant Conditioner to the cooling system following directions on the container.

IMPORTANT: Summer Engine Coolant Conditioner is NOT AN ANTIFREEZE or a cooling system sealer. Drain system and fill with recommended antifreeze solution as required for winter protection. When antifreeze solution is in system, it should not be necessary to use the conditioner; however, should severely corrosive water conditions be present, the conditioner is compatible with antifreeze solutions.

OPERATING THE ENGINE

ENGINE INSTRUMENTS AND CONTROLS

CHOKE (Gasoline Engine only)



X 2228

Pull choke control all the way out when starting engine. After engine is started, and for normal operation, push choke control all the way in.

Throttle

Move throttle one quarter forward when starting engine. Move throttle all the way forward for normal operation; move throttle all the way rearward for slow idle.

Key Switch

Turn the key to "ON" to check the operation of the alternator indicator light. It should glow red.

Turn the key to "START" and hold until engine starts.

Release the key when the engine starts. The alternator indicator light should go out.

If the light does not go out after 10 seconds, shut off engine at once and determine the cause.

If the engine fails to start, refer to the trouble shooting charts on page 115.

Alternator Indicator Light

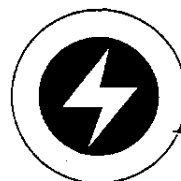

GLOWS RED IF ALTERNATOR IS NOT CHARGING

X 2229

This light glows red when the alternator is not charging. If the light goes on while the engine is running, stop engine and determine cause.

Check the operation of this light by turning the key to the "ON" position.

Coolant Temperature Gauge

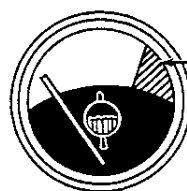

RED-ORANGE WARNING ZONE

X2231

This gauge indicates the coolant temperature in the cooling system—not the quantity. The white zone on the dial indicates normal operating temperature; the red-orange zone indicates above normal operating temperature.

If the pointer on the gauge goes into the red-orange zone, stop the engine and determine the cause.

Coolant Temperature Warning Horn

The low note horn sounds when the coolant temperature gauge registers "HOT" or when the straw walker sensing unit (attachment) is activated.

If the horn sounds, stop the engine. If the straw walkers are not plugged, check the engine to determine the cause of overheating.

Engine Oil Pressure Gauge

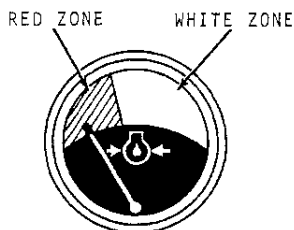

X 2232

This gauge indicates the pressure of the engine lubricating oil—not the amount of oil in the crankcase. Oil pressure will vary slightly with wear, but with recommended oil, it should read NORMAL at full governed speed (indicated by white zone on the dial). If oil pressure drops (indicated by red zone on the dial), stop immediately and determine the cause.

Fuel Gauge

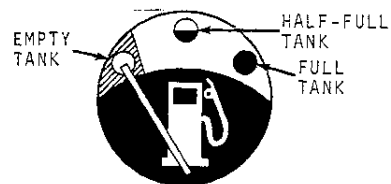

X 2233

The red-orange zone indicates that the tank is empty. A half-full mark and a full mark indicates the fuel level in the tank.

Engine Tach-Hour Meter

The tach-hour meter shows the engine speed in hundreds of rpm and accumulated engine service in hours and tenths of hours (based on an average engine operating speed of 2500 rpm). Use this hour meter to determine when lubrication and periodic services are needed.

Air Restriction Indicator (Attachment)

The red signal in the restriction indicator is locked in view whenever the air cleaner element is dirty and needs servicing. Check the indicator every 10 hours and if necessary service the element (page 106).

STARTING THE DIESEL ENGINE

1. If the engine has not been operated for a long period of time, or if the fuel tank has run dry, bleed the entire fuel system to remove air bubbles (page 94).

IMPORTANT: Never let the fuel tank run dry.

2. If starting in cold weather, see "Cold Weather Operation," page 5.

3. Disengage platform or corn head electromagnetic clutch switch, separator control lever, and grain tank unloading auger lever.

4. Place gearshift lever in neutral.

5. Depress clutch pedal fully.

6. Move throttle lever one-quarter open.

7. Turn key to "ON." Check the operation of the alternator indicator light. It should glow red.

8. Turn key to "START."

9. After the engine starts, release the key.

IMPORTANT: When starting the engine, never hold the key in start position for more than 30 seconds at a time. If the engine does not start within 30 seconds, allow at least 2 minutes for proper cooling of the starter. Be sure to pause a few seconds after a false start to make certain that the starter has stopped completely before another start is attempted.

If the engine fails to start, see TROUBLE SHOOTING page 115.

10. Make certain the oil pressure gauge registers pressure, and the alternator indicator light goes off. If not, stop engine and determine the cause.

11. Warm the engine and transmission for 5 minutes at fast idle—no load.

STOPPING THE DIESEL ENGINE

Set the throttle at medium idle speed and allow the engine to run at this speed until the temperature gauge drops well into the white range on dial. Move the throttle to the rear and turn key to "OFF."

IMPORTANT: Do not attempt to stop engine by turning off fuel supply at tank. Doing so will cause injection pump to run dry and damage internal parts.

STARTING THE GASOLINE ENGINE

1. If starting in cold weather, see "Cold Weather Operation," page 5.

2. Disengage platform or corn head electromagnetic clutch switch, separator control lever, and grain tank unloading auger lever.

3. Place gearshift lever in neutral.

4. Depress clutch pedal fully.

5. Move throttle lever one-quarter open.

6. Pull the choke control up.

7. Turn key to "ON." Check the operation of the alternator indicator light. It should glow red.

8. Turn key to "START."

After engine starts, release key and push the choke control down.

IMPORTANT: When starting the engine, never hold the key in start position for more than 30 seconds at a time. If the engine does not start within 30 seconds, allow at least 2 minutes for proper cooling of the starter. Be sure to pause a few seconds after a false start to make certain that the starter has stopped completely before another start is attempted.

If engine fails to start, see TROUBLE SHOOTING, page 115.

9. Make certain the oil pressure gauge registers pressure and the alternator indicator light goes off. If not, stop engine and determine the cause.

10. Warm the engine and transmission for 5 minutes at fast idle—no load.

STOPPING THE GASOLINE ENGINE

Set the throttle at medium idle speed and allow the engine to run at this speed for a few minutes before stopping.

Turn key to "OFF."

OPERATOR'S PLATFORM COMPONENTS

OPERATOR'S SEAT

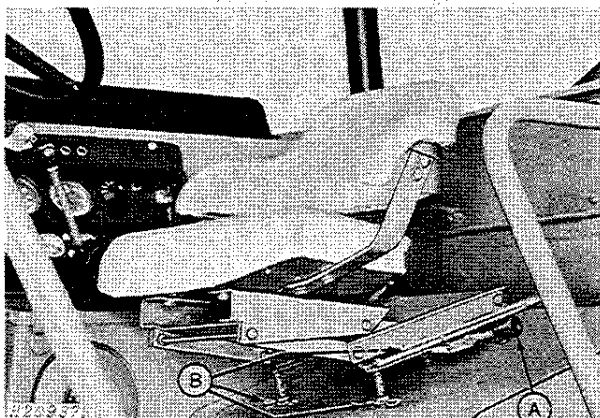

Seat in Sitting Position

The operator's seat moves forward and rearward or up and down to accommodate individual height and allows greater accessibility to all controls. If the operator wishes to stand, the seat can be positioned out of the way to allow ample leg space.

Use only warm water and mild soap to clean the seat cushions. NEVER USE SOLVENTS.

Positioning the Seat Forward or Rearward

While sitting in the seat, push lever "A" forward as far as possible and, by using your weight, adjust seat to desired position. Then release lever "A."

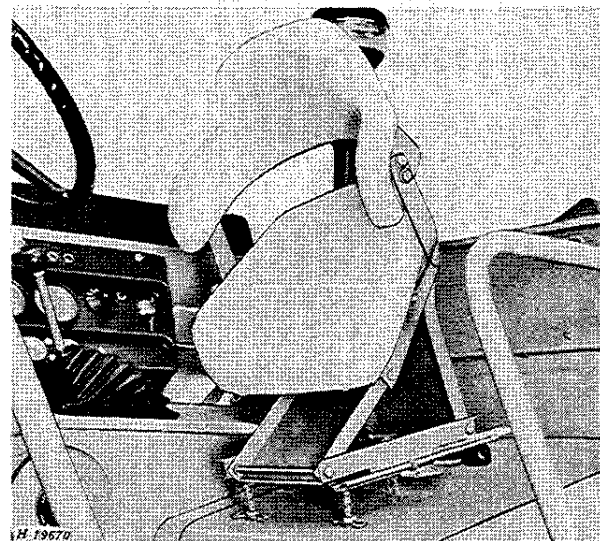

Seat in Standing Position

Positioning the Seat Up or Down

Remove four spring locking pins "B." Raise or lower the seat to the desired height. Reinsert spring locking pins "B."

Positioning the Seat for Standing

To move the seat up and back, stand up and apply pressure to the front of the seat with the back of your legs. The seat will move to the up and back position to allow standing room.

To return the seat to the sitting position, move the seat forward by pulling on the front of the seat with your hand.

STEERING COLUMN

The steering column is adjustable to one of four positions for individual arm lengths. This allows better visibility and greater accessibility to the steering wheel and controls on the steering column.

Steering Column Control

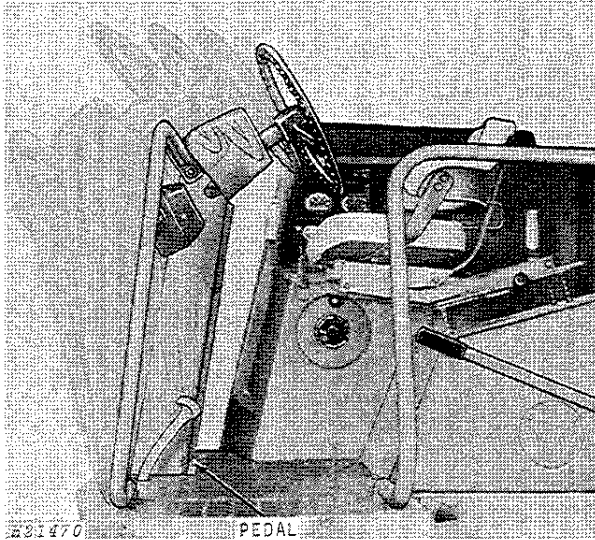

To adjust steering column push pedal down, position column to desired setting, and release pedal.

The world's best safety device is a careful operator.

PIVOTING LADDER

Move the pivoting ladder up out of the way of uncut crop to avoid crop loss by ladder impact.

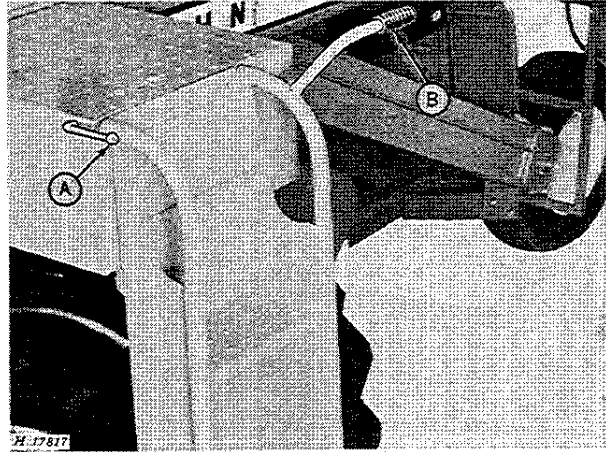

To move ladder, pull lever "A" up and to the right to release the lock.

Pull lever "B" forward until the ladder is parallel to the ground.

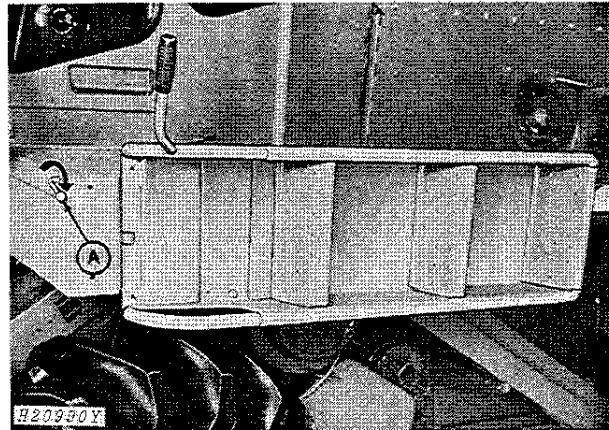

Push lever "A" to the left and down to lock ladder in place.

To lower the ladder, reverse the above procedure.

TRANSPORTING

The combine can be transported by driving it under its own power, carrying it on a truck, or by towing. When towing combine, remove the drive shafts between final drives and differential. Use caution when towing.

When applying brakes during transporting, be certain equal pressure is applied to both pedals.

Reduce the width of the combine by folding the unloading auger back along the separator and removing the platform or corn head. Over-all dimensions are given on page 134.

If the platform or corn head and feeder house are removed, the hydraulic cylinders must be wired or supported by chains no closer to separator support channel than 14 inches. Damage may result to hoses if carried too close.

If the platform or corn head is left on, raise platform or corn head to a position allowing good visibility.

Reduce the spread of noxious weed seeds by thoroughly cleaning the combine before leaving one field and going to the next.

Sweep trash and straw from the outside of combine. Open doors at bottom of elevators, remove—grain tank drain hole cover, and run combine until all straw, trash, and grain are removed from inside. Shut off combine engine. Clean out shoe grain supply augers (page 64).

The combine is equipped with a slow moving vehicle emblem on the rear hood, lights, grain tank reflectors, and red reflective tape on the backside of the platform or corn head for transporting protection. Keep the emblem, reflectors, and lights clean.

 **CAUTION: When driving the combine on a road or highway at night or during the day, use lights and devices provided for adequate warning to the operators of other vehicles. In this regard, check local governmental regulations.**

If flashing lights are prohibited by local regulations, reconnect wires so lights will not flash (page 90).

When unloading auger is folded back along the separator, raise the unloading auger scoop so it does not block the left-hand warning light from view of vehicles approaching from the rear.

FIELD AND CROP OPERATING ADJUSTMENTS

This section explains adjustments which are made due to crop or field conditions. Adjustments which are made to compensate for wear or misalignment are explained in the SERVICE section, page 45. For illustrations of controls not shown in this section, see the CONTROLS AND INSTRUMENTS section, page 2.

PLATFORM OR CORN HEAD

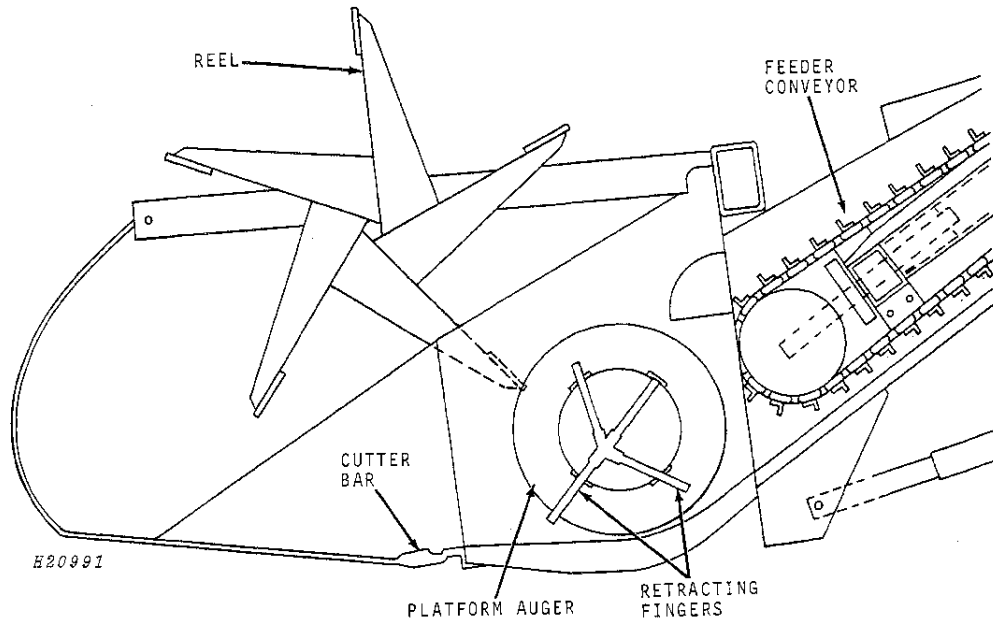

Cutting Platform Illustrated

The cutting platform illustrated above is only one of the headers which can be attached to the front of the feeder house. For complete information on these headers (cutting platform, pickup platform, belt pickup, and corn head) see the operator's manual supplied with them.

The platform or corn head receives the crop and moves it to the front of the feeder house by means of an auger.

Height of the platform or corn head can be changed by moving the height control lever located on the steering column. As a safety measure, platform or corn head height cannot be changed unless the engine is running.

An electromagnetic clutch permits stopping the platform or corn head and feeder house while the separator continues to run. The clutch is either engaged or disengaged by operating a switch on the control panel.

While servicing the platform or corn head, always use the hydraulic cylinder safety stop (page 46).

Platform or Corn Head Electromagnetic Clutch Switch

Push switch in to disengage clutch. Push switch in again to engage clutch.

Platform or Corn Head Height Control Lever

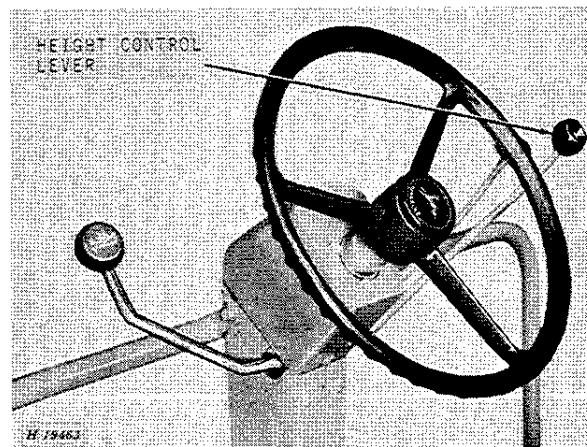

To lower the platform or corn head, move the height control lever forward.

To raise the platform or corn head, move the lever rearward.

Regulate the speed of lowering by turning a cap screw on the control valve (page 83).

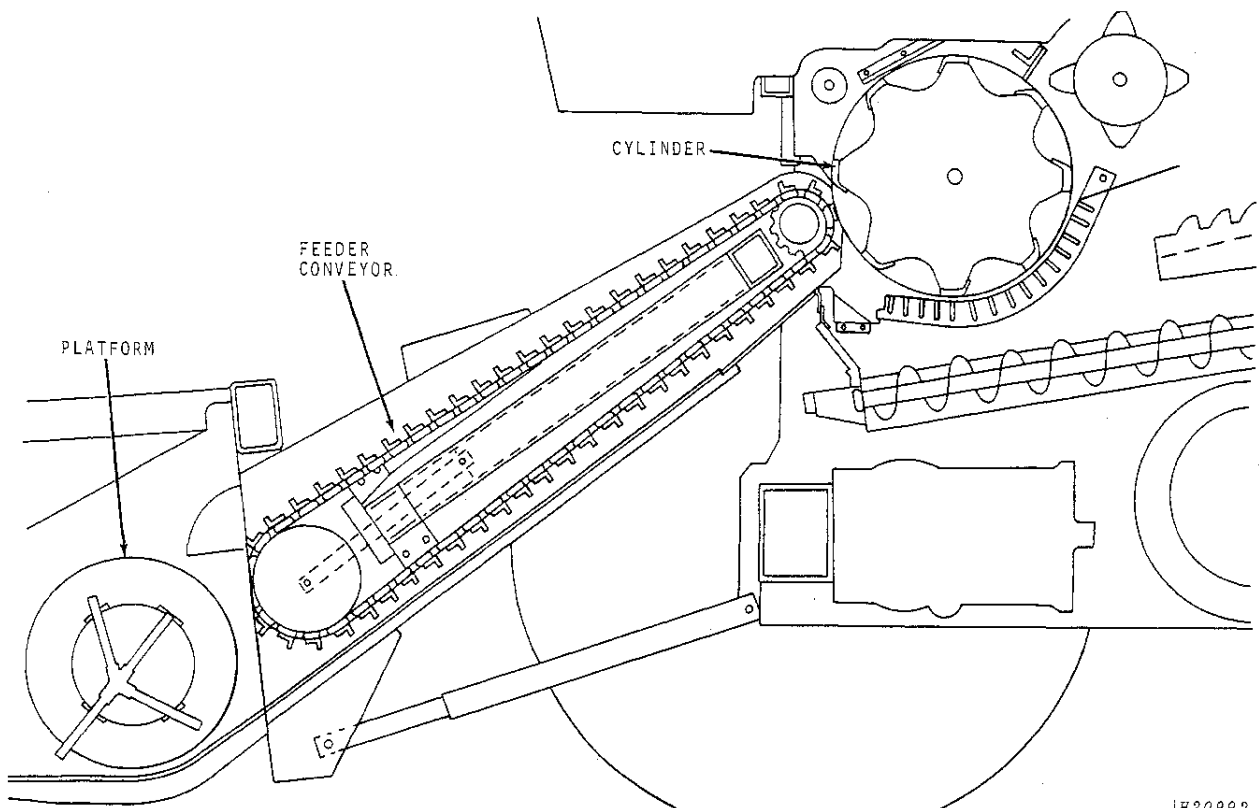
FEEDER HOUSE

The feeder house receives the grain from the platform or corn head and force feeds it to the threshing cylinder.

The speed of the feeder house determines the speed of the platform or corn head.

When combining grain, the feeder house speeds must be as specified (page 26) to maintain correct platform speeds.

IMPORTANT: When attaching a platform to the feeder house, adjust the feeder house speeds as shown (page 47). Never alter speeds from these specifications when combining grain.

When combining corn, change the feeder house speeds by changing sprockets. See the corn head operator's manual for correct speeds.

Conveyor Chain

Adjust the chain so a 5-1/8-inch dimension exists between the top of the roller chain and the top of the feeder house at mid-point of front door (page 48). At this dimension, the slats should just begin to rise off the rear of the feeder house bottom at the row of countersunk bolts. Too much slack allows the chain links to jump the sprocket teeth. Do not over-tighten the chain.

Conveyor Chain "Float"

Floating action of the conveyor accommodates varying volumes of material. Adjust the conveyor "float" so a 1/8-inch space exists between a slat and the feeder house bottom directly under the feeder drum (page 49).

SEPARATOR

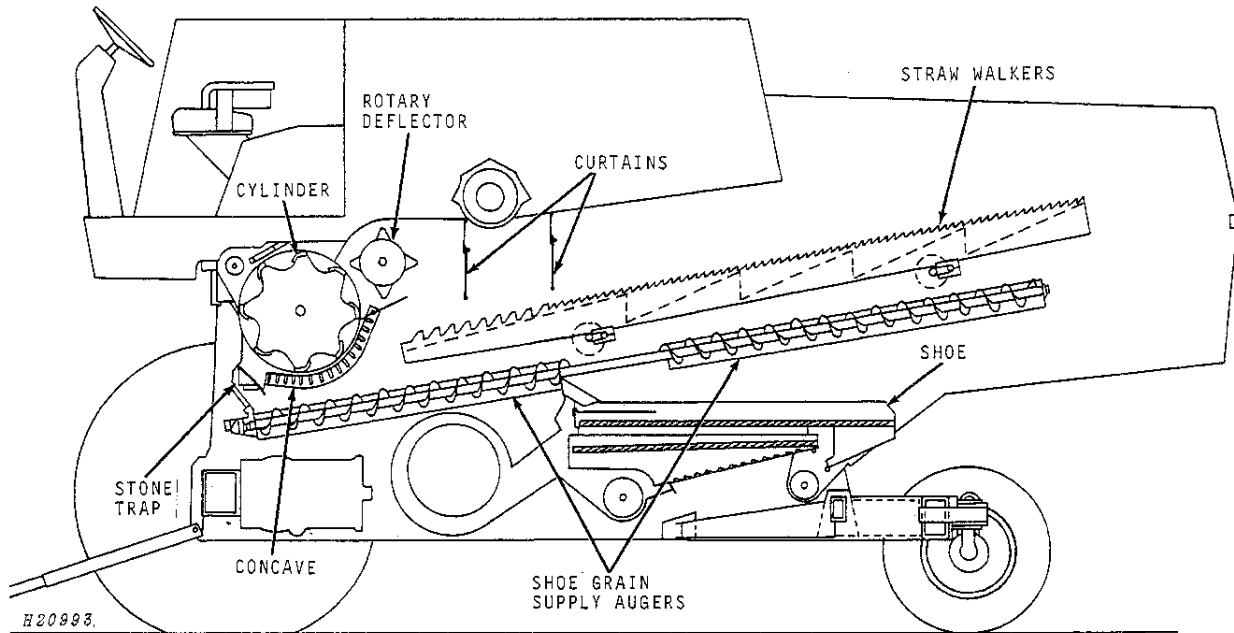

The separator receives the force fed material from the feeder conveyor and separates up to 90 percent of the grain from the straw at the cylinder and concave. This free grain falls immediately through the concave grate into the shoe grain supply augers.

The remaining straw and grain pass under the rotary deflector and curtains which regulate the flow of straw onto the straw walkers. The walkers lift and tumble the straw permitting the remaining grain to fall through the walkers into the shoe grain supply augers. The straw is carried over the walkers and out of the combine.

The shoe grain supply augers are positioned under the cylinder and concave and extend to the rear of the straw walkers. The front half of each auger conveys grain from the cylinder and concave rearward to the front of the cleaning shoe. Flights on the rear half of each auger are reversed to convey grain that falls through the straw walkers forward to the front of the cleaning shoe.

Regardless of the crop harvested, good separation is directly dependent on the speed of the separator. The separator speed is determined by the speed of the primary countershaft. Keep primary countershaft speed at 1500-1510 rpm with engine at full throttle - no load (page 62).

Reducing the primary countershaft speed reduces the speed of the platform or corn head, straw walker, cleaning shoe (chaffer and sieve), elevators and augers. This sluggishness can result in clogging and grain loss.

Increasing the primary countershaft speed causes material to pass through the combine too rapidly, causing grain loss and strain and wear on all moving parts.

CAUTION: Do not engage separator until everyone is standing away from moving parts or belts.

The separator is engaged or disengaged by moving the separator control lever on the operator's platform.

Separator Control Lever

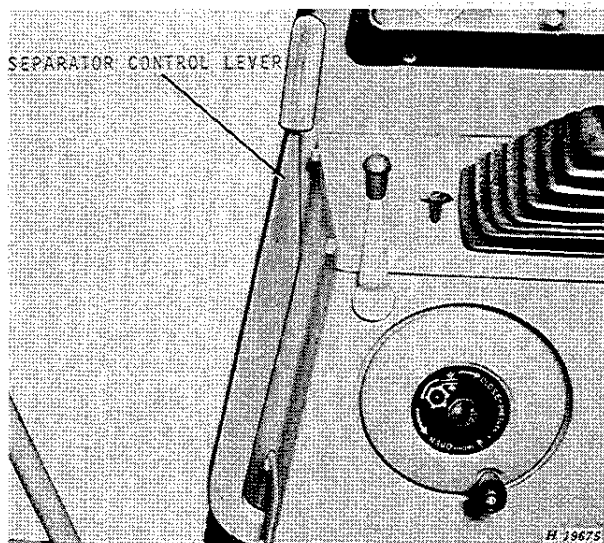

To engage the separator, push lever forward.

To disengage the separator, pull lever rearward.

Cylinder (Rasp-Bar and Spike-Tooth)

Good threshing depends on proper relationship between the cylinder speed and the cylinder-concave spacing. A large seed requires low speed and a wide spacing to prevent cracking; a small seed requires high speed and a close spacing so the seed will be rubbed out.

Between these two extremes are the many crops a combine is expected to handle. Carefully select the best relationship for each crop (page 28). Neglect or carelessness can mean heavy crop losses.

This combine is equipped with a variable speed cylinder with a speed range from 387 to 1172 rpm. A special drive sheave may be purchased from your John Deere dealer to provide a slower speed range (311 to 942 rpm) for combining large seed (page 57).

Change cylinder speed by moving the cylinder speed control ratchet located on the console. A tachometer in the instrument panel registers the cylinder rpm's by hundreds.

Cylinder Speed Tachometer

The tachometer registers cylinder rpm's by hundreds. It aids in maintaining the correct cylinder speed for a particular crop.

Cylinder Speed Control Ratchet

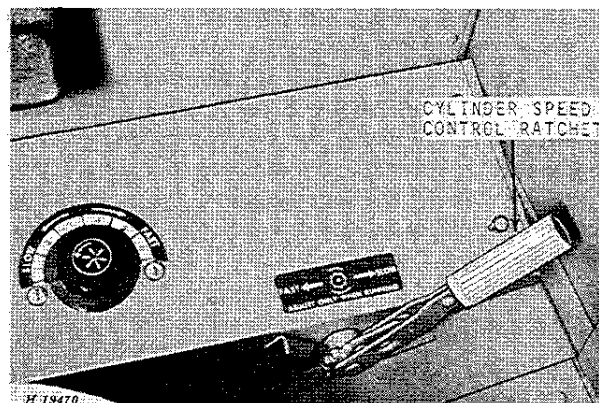

Before changing cylinder speed, place the ratchet pawl in the proper position.

To increase the cylinder speed, move the ratchet toward "FAST."

To decrease the cylinder speed, move the ratchet toward "SLOW."

IMPORTANT: Adjust the cylinder speed only when the separator is running.

See suggested settings chart, page 28.

Choked Cylinder

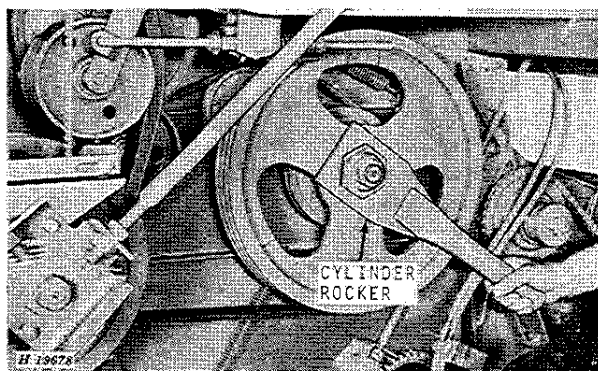

If the cylinder becomes choked, open concave and run separator to clear cylinder.

If cylinder remains choked, shut off engine, leave concave fully open, and remove all straw and other material from front of concave through the cylinder front door. Place the cylinder rocker on the nut on the right-hand end of the cylinder shaft. Rock the cylinder back and forth until the cylinder is clear.

IMPORTANT: Continued running of the separator with a choked cylinder will cause damage to sheaves and V-belts due to belt slippage.

Be certain to adjust the concave to original position after the cylinder has been cleared.

Concave (Rasp-Bar)

The concave may be adjusted from almost no spacing to a front spacing of 1-1/2 inches measured at the fourth grate bar. It is designed so the rear spacing automatically increases or decreases to half the front spacing. Thus, the rear of the concave never needs adjusting unless the concave is replaced or the rear spacing is disturbed (page 59). Adjust the concave with the concave opening control wheel located on the console.

Concave (Spike-Tooth)

The combine is shipped from the factory with two grate concaves and one tooth concave installed to the front.

An extra tooth concave is provided, to be used only if raising the concaves and speeding up the cylinder have failed to achieve the desired results. It is usually better to use one tooth concave set fairly high than two tooth concaves set low. The use of two tooth concaves requires increased power, is likely to crack grain, and will break up the straw excessively, which could overload the cleaning shoe. However, when operating in a light crop, damp grain, or varieties that are difficult to thresh, it may be advisable to install the extra tooth concave.

The tooth concaves are installed to the front with the grate concaves to the rear.

There should be equal spacing between the cylinder and concave teeth on each side with the concave in high position and the teeth straight and properly adjusted (page 60).

If concave teeth are set closer to the cylinder teeth on one side in the front row, than on the opposite side in the second row, the opening will be too large on one side, thus permitting grain heads to pass through unthreshed. The opening on the other side will be too small, resulting in grain being cracked and straw being broken up too much. Level concave (page 61).

The spike-tooth concave is designed so the rear spacing increases or decreases proportionally with the front spacing. Thus, the rear of the concave never needs adjusting unless the concave is replaced or the rear spacing is disturbed (page 61). Adjust the front of the concave with the concave opening control wheel located on the console.

Concave Opening Control Wheel (Rasp-Bar and Spike-Tooth)

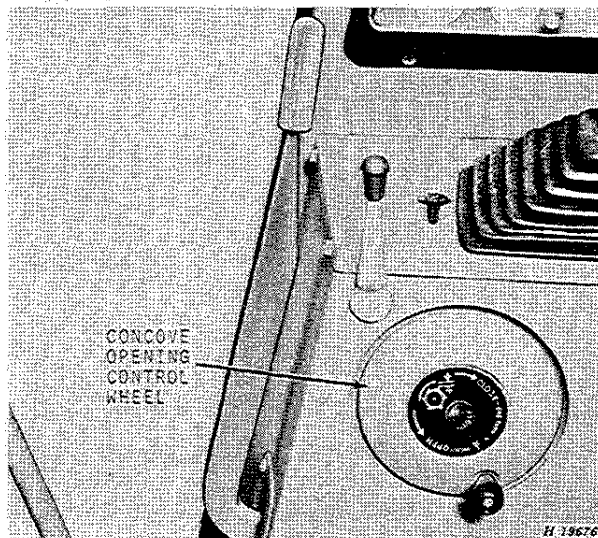

Loosen locking knob.
 To open the concave, turn the wheel toward "OPEN."
 To close the concave, turn the wheel toward "CLOSE."
 Tighten locking knob.

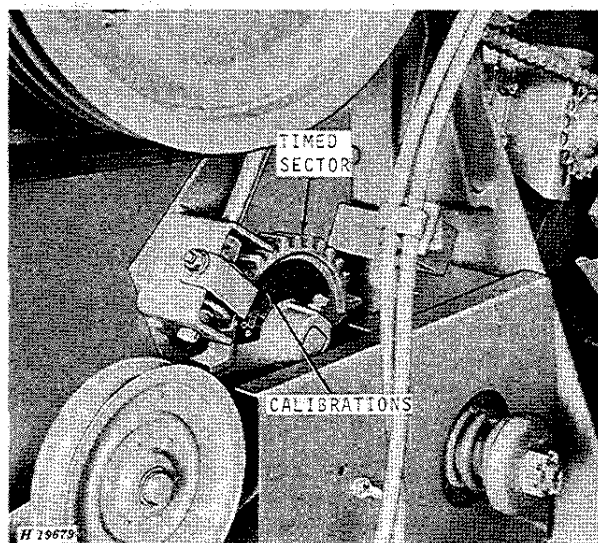

The timed sector located on the worm gear to the right of the cylinder is calibrated to indicate the setting at the front of the rasp-bar concave.
 With the spike-tooth concave, use the calibrations as a guide to return to the concave spacing that was previously found best for a particular crop or field condition.
 See Suggested Settings Chart, page 28.



Suggest:

If the above button click is invalid.

Please download this document

first, and then click the above link

to download the complete manual.

Thank you so much for reading

Separator Curtains

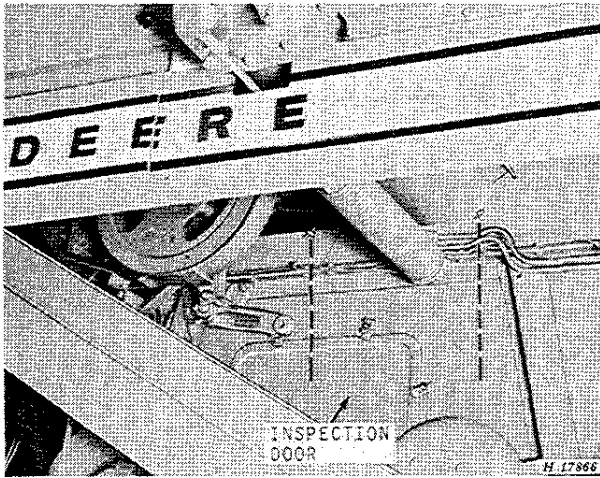

The curtains help regulate the flow of straw onto the straw walkers. In almost all operating conditions, both curtains should be used.

If backfeeding occurs at the cylinder, remove the front curtain by removing the cotter pin at each end of the support rod and pull curtain out through the inspection door.

Trough-Type Stone Trap

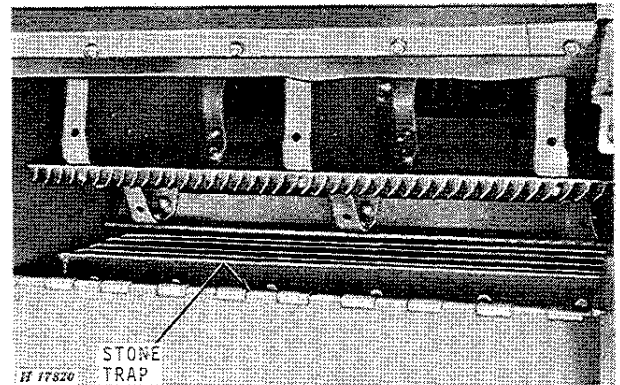

A trough-type stone trap protects the cylinder and concave from stone damage. Stones accumulate in the trap while the grain passes into the cylinder for threshing.

Check the stone trap daily and remove any stones that have accumulated.

<https://www.ebooklibonline.com>

Hello dear friend!

Thank you very much for reading.

Enter the link into your browser.

The full manual is available for immediate download.

<https://www.ebooklibonline.com>