

**JOHN DEERE**  
**WORLDWIDE COMMERCIAL & CONSUMER**  
**EQUIPMENT DIVISION**

---

**Riding Greens Mower**  
**2500B and 2500E Hybrid**

OMTCU22479 D7

**OPERATOR'S MANUAL**



**JOHN DEERE**

Export Version  
Litho in U.S.A.

# INTRODUCTION

---

## Thank You for Purchasing a John Deere Product

We appreciate having you as a customer and wish you many years of safe and satisfied use of your machine.

## Using Your Operator's Manual

This manual is an important part of your machine and should remain with the machine when you sell it.

Reading your operator's manual will help you and others avoid personal injury or damage to the machine. Information given in this manual will provide the operator with the safest and most effective use of the machine. Knowing how to operate this machine safely and correctly will allow you to train others who may operate this machine.

If you have an attachment, use the safety and operating information in the attachment operator's manual along with the machine operator's manual to operate the attachment safely and correctly.

This manual and safety signs on your machine may also be available in other languages (see your authorized dealer to order).

Sections in your operator's manual are placed in a specific order to help you understand all the safety messages and learn the controls so you can operate this machine safely. You can also use this manual to answer any specific operating or servicing questions. A convenient index located at the end of this book will help you to find needed information quickly.

The machine shown in this manual may differ slightly from your machine, but will be similar enough to help you understand our instructions.

RIGHT-HAND and LEFT-HAND sides are determined by facing in the direction the machine will travel when going forward. When you see a broken line (-----), the item referred to is hidden from view.

Before delivering this machine, your dealer performed a predelivery inspection to ensure best performance.

## Machine Use

This machine is designed solely for use in customary lawn and turf mowing operations. Use in any other way is considered as contrary to the intended use.

The manufacturer accepts no liability for damage or injury resulting from this misuse, and these risks must be borne solely by the user. Compliance with and strict adherence to the conditions of operation, service and repair as specified by the manufacturer also constitute essential elements for

the intended use.

This machine should be operated, serviced and repaired only by persons familiar with all its particular characteristics and acquainted with the relevant safety rules (accident prevention). The accident prevention regulations, all other generally recognized regulations on safety and occupational medicine and the road traffic regulations must be observed at all times.

Setting fuel delivery beyond published factory specifications or otherwise overpowering will result in loss of warranty protection for this machine.

Any arbitrary modifications carried out on this machine will relieve the manufacturer of all liability for any resulting damage or injury.

## Special Messages

Your manual contains special messages to bring attention to potential safety concerns, machine damage as well as helpful operating and servicing information. Please read all the information carefully to avoid injury and machine damage.



**CAUTION: Avoid injury! This symbol and text highlight potential hazards or death to the operator or bystanders that may occur if the hazards or procedures are ignored.**

**IMPORTANT: Avoid damage! This text is used to tell the operator of actions or conditions that might result in damage to the machine.**

**NOTE: General information is given throughout the manual that may help the operator in the operation or service of the machine.**

# PRODUCT IDENTIFICATION

---

## Record Identification Numbers

### Greensmowers

2500B PIN (010001- )

2500E Hybrid PIN (010001- )

If you need to contact an Authorized Service Center for information on servicing, always provide the product model and identification numbers.

You will need to locate the identification numbers for the product. Record the information in the spaces provided below.

DATE OF PURCHASE:

\_\_\_\_\_

DEALER NAME:

\_\_\_\_\_

DEALER PHONE:

\_\_\_\_\_

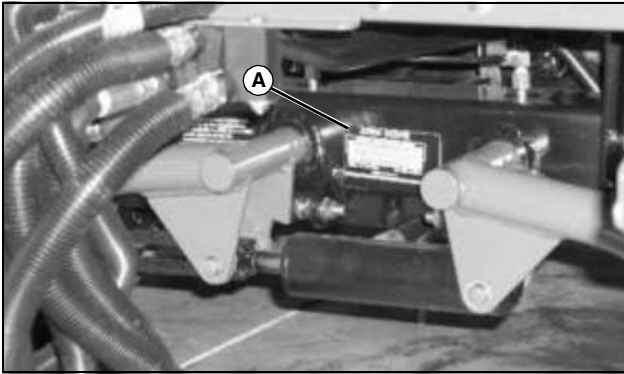

MX23192

PRODUCT IDENTIFICATION NUMBER (A):

-----  
-----

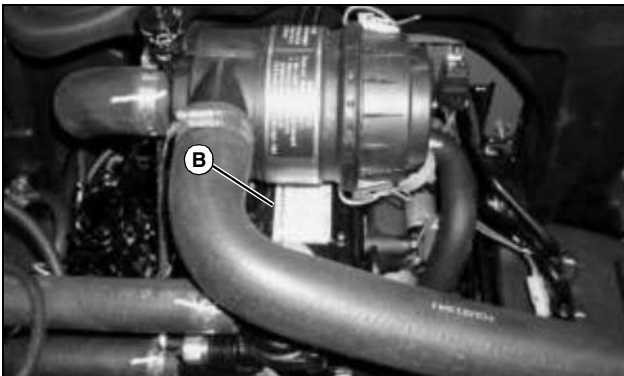

MX23191

DIESEL ENGINE SERIAL NUMBER (B):

-----

**<https://www.ebooklibonline.com>**

Hello dear friend!

Thank you very much for reading.

Enter the link into your browser.

The full manual is available for immediate download.

**<https://www.ebooklibonline.com>**

# TABLE OF CONTENTS

---

Safety Labels .....	1
Safety .....	4
Operating Controls .....	10
Operating .....	12
Operating - Cutting Units .....	22
Replacement Parts .....	34
Service Intervals .....	35
Service Lubrication .....	37
Service Engine .....	40
Service Transmission .....	51
Service - Hydraulics .....	55
Service Cutting Units .....	60
Service Electrical .....	73
Service Miscellaneous .....	77
Troubleshooting .....	81
Storage .....	90
Assembly .....	92
Specifications .....	99
Declaration of Conformity .....	103
Index .....	105

All information, illustrations and specifications in this manual are based on the latest information at the time of publication. The right is reserved to make changes at any time without notice.

COPYRIGHT© 2007  
Deere & Co.  
John Deere Worldwide Commercial and  
Consumer Equipment Division  
All rights reserved  
Previous Editions  
COPYRIGHT© 2006

OMTCU22479 D7 - English

# SAFETY LABELS



## Pictorial Safety Signs

At several important places on this machine safety signs are affixed intended to signify potential danger. The hazard is identified by a pictorial in a warning triangle. An adjacent pictorial provides information how to avoid personal injury. These safety signs, their placement on the machine and a brief explanatory text are shown in this Safety section.

## Roll-Over Protective Structure

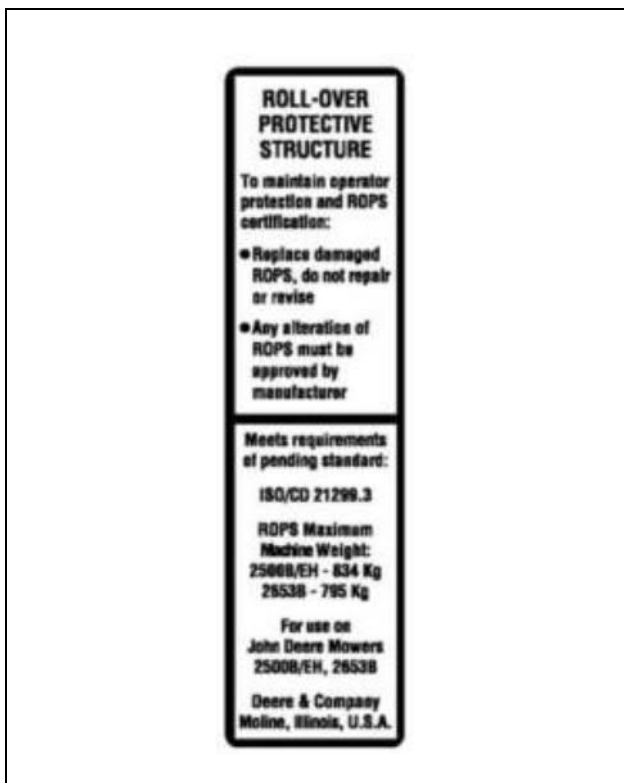

TCU22765

### To maintain operator protection and ROPS certification:

- Replace damaged ROPS, do not repair or revise
- Any alteration of ROPS must be approved by manufacturer

### Meets requirements of pending standard:

- ISO/CD 21299.3
- ROPS Maximum Machine Weight: 2500B/EH - 834Kg, 2653B - 795Kg
- For use on John Deere Mowers 2500B/EH, 2653B
- Deere & Company Moline, Illinois, U.S.A.

## Bypass Valve Label

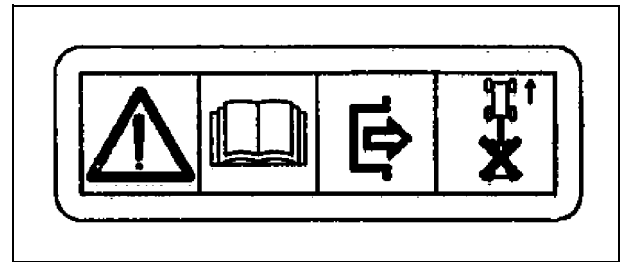

M123057

Read operator's manual before operating the bypass valve. Prevent hydrostatic damage. Push or pull greensmower by hand only. Do not use another vehicle to push or pull the greensmower.

## Avoid Injury From Battery Gases and Acid

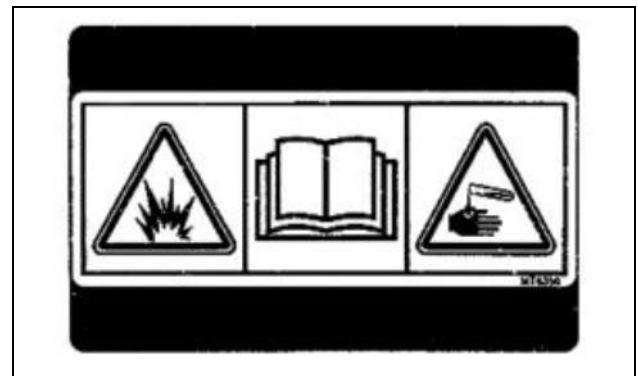

MT6350

### Explosive Gases

Cigarettes, flames or sparks could cause the batteries to explode. Always shield eyes and face from the batteries. Do not charge or use booster cables or adjust poor connections without proper instruction and training. Keep vent caps tight and level.

### Causes Severe Burns

Contains sulfuric acid. Avoid contact with skin, eyes or clothing. In event of an accident, flush with water and call a physician immediately. Keep out of reach of children.

# SAFETY LABELS

## Warning

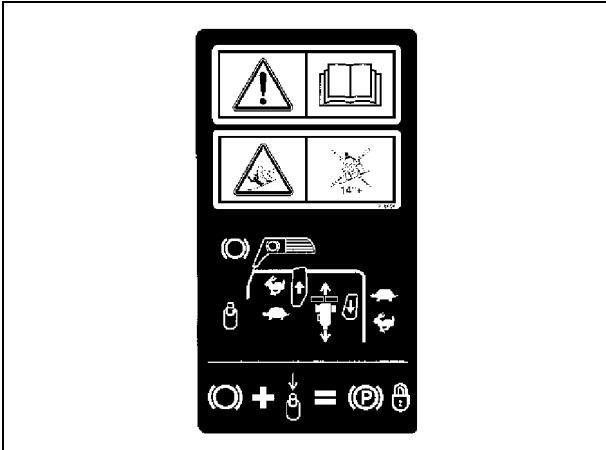

MT6494

- Read Operator's Manual before operating machine.
- Do not drive where machine could slip, tip, or rollover.
- Do not drive on a slope with more than a 14° (24%) incline.
- Before leaving operator station:
  - Stop engine.
  - Set park brake.
  - Remove key.

## Backlap Valve Label

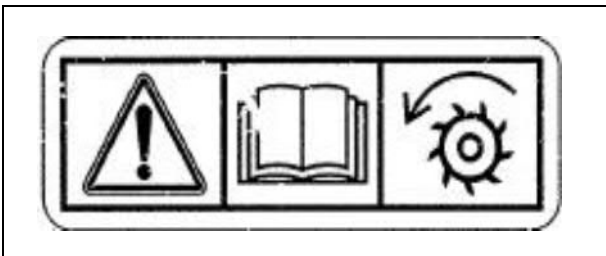

MT6727

- Read Backlapping Cutting Units in the Service-Cutting Units section of the operator's manual before operating the backlap valve.
- Avoid injury from rotating blades. Keep hands and feet away while greensmower is running.

## Warning

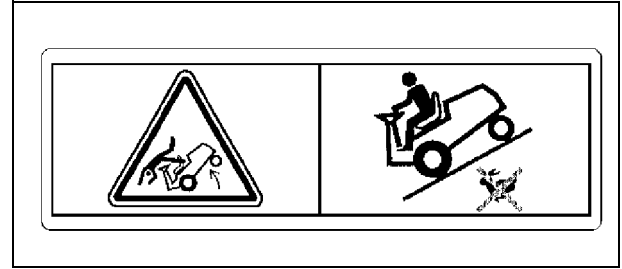

MT6523

To avoid injury, avoid quick stops and reduce speed on slopes.

## Caution

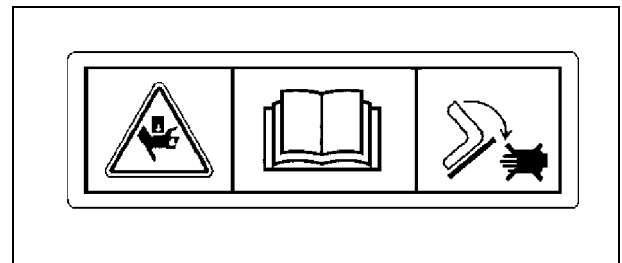

MT6729

- Avoid hand injuries.
- Read the Operator's Manual.
- Do not perform service functions under seat platform unless properly secured in the raised position.

# SAFETY LABELS

## Warning

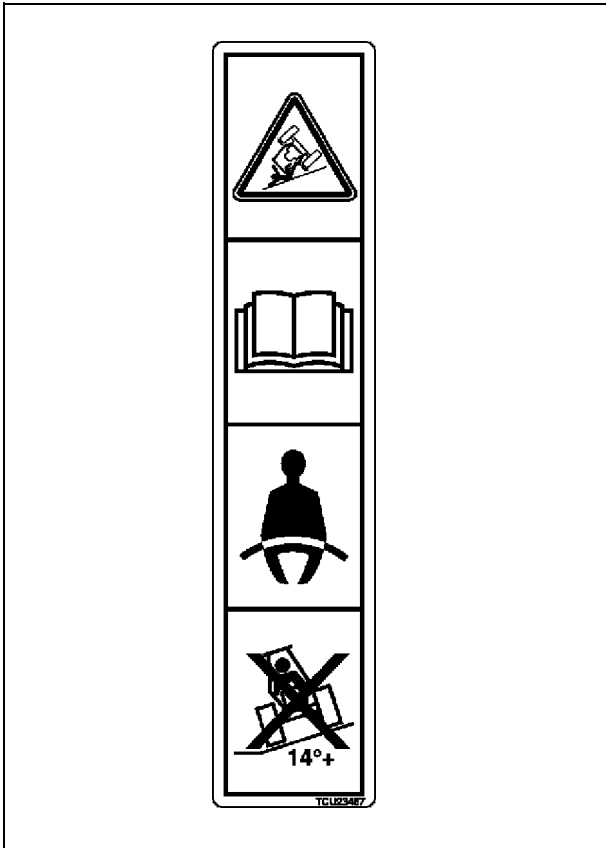

TCU23487

- To avoid injury from crushing, always wear seat belt. Do not jump from machine.
- Read the Operator's Manual.
- Always use seat belt.
- Do not operate on a slope greater than 14 degrees.

## Warning



TCU20685

- Avoid hot surface.
- Keep people a safe distance away.

## CE Certification and Specification Label

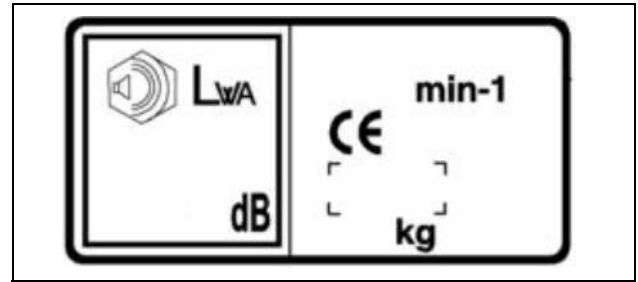

MT7210

- This label on your machine indicates that this model has been certified and is in compliance with European Directive 98/37EEC (89/392EEC) and 2000/14/EC Standards.

---

# SAFETY

---

## Training

- Read the instructions carefully. Be familiar with the controls and the proper use of the equipment.
- Never allow children or people unfamiliar with these instructions to use the lawnmower. Local regulations can restrict the age of the operator.
- Never mow while people, especially children, or pets are nearby.
- Keep in mind that the operator or user is responsible for accidents or hazards occurring to other people or their property.
- Do not carry passengers.
- All drivers should seek and obtain professional and practical instruction. Such instruction should emphasize:
  - the need for care and concentration when working with ride-on machines.
  - control of a ride-on machine sliding on a slope will not be regained by the application of the brake.
- The main reasons for loss of control are:
  - insufficient wheel grip;
  - being driven too fast;
  - inadequate braking;
  - the type of machine is unsuitable for its task;
  - lack of awareness of the effect of ground conditions, especially slopes;
  - incorrect hitching and load distribution.

## Preparation

- While mowing, always wear substantial footwear and long trousers. Do not operate the equipment when barefoot or wearing open sandals.
- Thoroughly inspect the area where the equipment is to be used and remove all objects which can be thrown by the machine.
- **WARNING-Fuel is highly flammable.**
  - store fuel in containers specifically designed for this purpose.
  - refuel outdoors only and do not smoke while refueling.
  - add fuel before starting the engine. Never remove the cap of the fuel tank or add fuel while the engine is running or when the engine is hot.
  - if fuel is spilled, do not attempt to start the engine but move the machine away from the area of spillage and

avoid creating any source of ignition until fuel vapors have dissipated.

- replace all fuel tank and container caps securely.
- Replace faulty silencers.

## Operation

- Do not operate the engine in a confined space where dangerous carbon monoxide fumes can collect.
- Mow only in daylight or in good artificial light.
- Before attempting to start the engine, disengage all blade attachment clutches and shift into neutral.
- Do not use on slopes of degrees more than recommended by the manufacturer.
- Remember there is no such thing as a safe slope. Travel on grass slopes requires particular care. To guard against overturning:
  - do not stop or start suddenly when going up or downhill;
  - engage clutch slowly, always keep machine in gear, especially when traveling downhill;
  - machine speeds should be kept low on slopes and during tight turns;
  - stay alert for humps and hollows and other hidden hazards;
  - never mow across the face of a slope, unless the machine is designed for this purpose.
- Use care when pulling loads or using heavy equipment:
  - use only approved drawbar hitch points;
  - limit loads to those you can safely control;
  - do not turn sharply. Use care when reversing;
  - use counterweights or wheel weights when suggested in the operator's manual.
- Watch out for traffic when crossing or near roadways.
- Stop the blades from rotating before crossing surfaces other than grass.
- Never direct discharge of material toward bystanders nor allow anyone near the machine while in operation.
- Never operate the machine with defective guards, or without safety protective devices in place.
- Do not change the engine governor settings or overspeed the engine. Operating the engine at excessive speed can increase the hazard of personal injury.
- Before leaving the operator's position:
  - disengage the drive to any attachments and lower

---

# SAFETY

---

them;

- change into neutral and lock the parking brake;
- stop the engine and remove the key.
- Disengage drive to attachments when transporting or not in use.
- Stop the engine and disengage drive to attachment:
  - before refueling;
  - before removing the grass catcher;
  - before making height adjustment unless adjustment can be made from the operator's position;
  - before clearing blockages;
  - before checking, cleaning or working on the lawnmower;
  - after striking a foreign object. Inspect the lawnmower for damage and make repairs before restarting and operating the equipment.
- Read, understand and follow all instructions in the manual and on the machine before starting.
- Inspect machine before you operate. Repair or replace damaged, badly worn, or missing parts. Make any necessary adjustments before you operate.
- Be sure all drives are in neutral and parking brake is locked before starting engine. Only start engine from the operator's position.
- Check brake action before you operate. Adjust or service brakes as necessary.
- Stop machine if anyone enters the area.
- Do not leave machine unattended when it is running.
- Use care when approaching blind corners, shrubs, trees, or other objects that may obscure vision.
- Use only accessories and attachments approved by the manufacturer of the machine. Keep safety labels visible when installing accessories and attachments.
- Do not operate machine if you are under the influence of drugs or alcohol.
- Check before each use that operator presence controls are functioning correctly. Test safety systems. Do not operate unless they are functioning correctly.
- Always wear seat belt if provided on machine.
- Never raise mower decks when blades are running.
- Do not wear radio or music headphones. Safe service and operation requires your full attention.

## Maintenance and Storage

- Keep all nuts, bolts and screws tight to be sure the equipment is in safe working condition.
- Never store the equipment with fuel in the tank inside a building where fumes can reach an open flame or spark.
- Allow the engine to cool before storing in any enclosure.
- To reduce the fire hazard, keep the engine, silencer, battery compartment and fuel storage area free of grass, leaves, or excessive grease.
- Check the grass catcher frequently for wear or deterioration.
- Replace worn or damaged parts for safety.
- If the fuel tank has to be drained, this should be done outdoors.
- Be careful during adjustment of the machine to prevent entrapment of the fingers between moving blades and fixed parts of the machine.
- On multi-cylinder machines, take care as rotating one cylinder can cause other cylinders to rotate.
- When machine is to be parked, stored or left unattended, lower the cutting means unless a positive mechanical lock is used.
- Use jack stands or lock service latches to support components when required. Securely support any machine elements that must be raised for service work.
- Before servicing machine or attachment, carefully release pressure from any components with stored energy, such as hydraulic components or springs.
- Release hydraulic pressure by lowering attachment or cutting units to the ground or to a mechanical stop and move hydraulic control levers back and forth.
- Disconnect battery or remove spark plug (for gas engines) before making any repairs. Disconnect the negative terminal first and the positive last. Reconnect positive first and negative last.
- Use care when checking reels. Wear gloves, and use caution when servicing them.
- Keep hands, feet, clothing, jewelry and long hair away from moving parts. If possible, do not make adjustments with the engine running.
- Charge batteries in an open well ventilated area, away from spark and flames. Unplug charger before connecting or disconnecting from battery. Wear protective clothing and use insulated tools.

# SAFETY

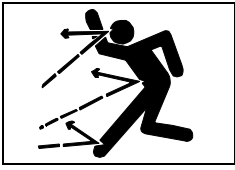

## Checking Mowing Area

- Clear mowing area of objects that might be thrown. Keep people and pets out of mowing area.

• Low-hanging branches and similar obstacles can injure the operator or interfere with mowing operation. Before mowing, identify potential obstacles such as low-hanging branches, and trim or remove those obstacles.

- Study mowing area. Set up a safe mowing pattern. Do not mow where traction or stability is doubtful.

## Parking Safely

1. Stop machine on a level surface, not on a slope.
2. Disengage mower blades or any other attachments.
3. Lower attachments to the ground.
4. Lock the park brake.
5. Stop the engine.
6. Remove the key.
7. Wait for engine and all moving parts to stop before you leave the operator's seat.
8. Close fuel shut-off valve, if your machine is equipped.
9. Disconnect the negative battery cable or remove the spark plug wire(s) (for gasoline engines) before servicing the machine.



## Avoid Injury From Contacting Blades

- Rotating cutting cylinders can cut off arms and legs, and throw objects. Failure to observe safety instructions

could result in serious injury or death.

- Keep hands, feet and clothing away from rotating cutting cylinders when engine is running.
- Be alert at all times, drive forward carefully. People, especially children can move quickly into the mowing area before you know it.
- Before backing up, stop cutting cylinders and look down and behind the machine carefully, especially for children.
- Do not mow in reverse.
- Shut off cutting cylinders when you are not mowing.
- Park machine safely before leaving the operator's station for any reason including emptying the grasscatchers.

- Keep all parts of the body away from the cutting edges. Residual hydraulic pressure in the system can cause cutting cylinder rotation when the blockage is released.
- Use a long-handled brush when applying reel-sharpening compound.
- Keep bystanders away from cutting units when adjusting or servicing.
- Always wear gloves when manually rotating reel. Manually rotating one reel can cause another reel to rotate.

## Protect Children

- Death or serious injury can occur when young children associate having fun with a lawn mowing machine simply because someone has given them a ride on a machine.
- Children are attracted to lawn mowing machines and mowing activities. They don't understand the dangers of rotating blades or the fact that the operator is unaware of their presence.
- Children who have been given rides in the past may suddenly appear in the mowing area for another ride and be run over or backed over by the machine.
- Tragic accidents with children can occur if the operator is not alert to the presence of children, especially when a child approaches a machine from behind. Before and while backing up, stop mower blades and look down and behind the machine carefully, especially for children.
- Never carry children on a machine or attachment, even with the blades off. Do not tow children in a cart or trailer. They can fall off and be seriously injured or interfere with safe machine operation.
- Never use the machine as a recreational vehicle or to entertain children.
- Never allow children or an untrained person operate the machine. Instruct all operators not to give children a ride on the machine or in an attachment.
- Keep children indoors, out of the mowing area, and in the watchful eye of a responsible adult, other than the operator, when a mower is being operated.
- Stay alert to the presence of children. Never assume that children will remain where you last saw them. Turn the machine off if a child enters the work area.

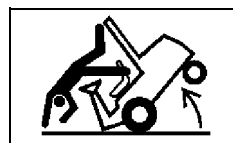

## Avoid Tipping

- Slopes are a major factor related to loss-of-control and tip-over accidents, which can result in severe injury or death. Operation on all slopes

# SAFETY

---

requires extra caution.

- If you feel uneasy on a hillside, do not mow it.
- Mow up and down slopes, not across.
- Watch for holes, ruts, bumps, rocks, or other hidden objects. Uneven terrain could overturn the machine. Tall grass can hide obstacles.
- Choose a low ground speed so you will not have to stop or shift while on a slope.
- Do not mow or operate machine on wet grass. Tires may lose traction. Tires may lose traction on slopes even though the brakes are functioning properly.
- Avoid starting, stopping or turning on a slope. If the tires lose traction, disengage the reels and proceed slowly, straight down the slope.
- Keep all movement on slopes slow and gradual. Do not make sudden changes in speed or direction, which could cause the machine to roll over.
- Do not mow near drop-offs, ditches, embankments, or bodies of water. The machine could suddenly roll over if a wheel goes over the edge or the edge caves in. Leave a safety area between the machine and any hazard.
- Drive machine very slowly and avoid quick stops when cutting units are removed.
- Transport machine with cutting units lowered to improve stability.

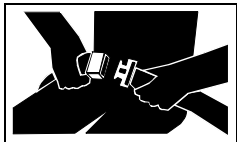

## Use Seat Belt Properly

- Use a seat belt when you operate with a Roll-Over Protective Structure (ROPS) to minimize chance of injury from an accident, such as an

overturn.

- Never modify, disassemble or attempt to repair the seat belt.
- Replace entire seat belt if mounting hardware, buckle, belt, or retractor show signs of damage.
- Inspect seat belt and mounting hardware at least once a year. Look for signs of loose hardware or belt damage, such as cuts, fraying, extreme or unusual wear, discoloration, or abrasion. Replace only with replacement parts approved by your John Deere dealer.
- Layers of heavy clothing can interfere with proper positioning of the seat belt and can reduce the effectiveness of the seat belt.

## Keep ROPS Installed Properly

- Never operate the machine without the ROPS installed.
- Make certain all parts of the ROPS are installed correctly if the ROPS structure is loosened or removed for any reason. All ROPS hardware should be tightened to the proper torque per manufacturer's recommendations.
- Any alteration of the ROPS must be approved by the manufacturer. The protection provided by the ROPS will be impaired if the ROPS is subjected to structural damage, is involved in an overturn incident, or is in any way altered by welding, bending, drilling, or cutting.
- Never attempt to repair a damaged or altered ROPS. It must be replaced to maintain the manufacturer's certification of the structure.

## Keep Riders Off

- Only allow the operator on the machine. Keep riders off.
- Riders on the machine or attachment may be struck by foreign objects or thrown off the machine causing serious injury.
- Riders obstruct the operator's view resulting in the machine being operated in an unsafe manner.

## Checking Wheel Hardware

- A serious accident could occur causing serious injury if wheel hardware is not tight.
- Check wheel hardware tightness often during the first 100 hours of operation.
- Wheel hardware must be tightened to specified torque using the proper procedure anytime it is loosened.

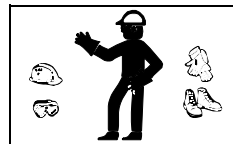

## Wear Appropriate Clothing

- Always wear safety goggles, or safety glasses with side shields, and a hard hat when operating the machine.
- Wear close fitting clothing and safety equipment appropriate for the job.
- While mowing, always wear substantial footwear and long trousers. Do not operate the equipment when barefoot or wearing open sandals.
- Wear a suitable protective device such as earplugs. Loud noise can cause impairment or loss of hearing.

# SAFETY



## Avoid High Pressure Fluids

- Hydraulic hoses and lines can fail due to physical damage, kinks, age, and exposure. Check hoses and lines regularly. Replace damaged hoses

and lines.

- Hydraulic fluid connections can loosen due to physical damage and vibration. Check connections regularly. Tighten loose connections.
- Escaping fluid under pressure can penetrate the skin causing serious injury. Avoid the hazard by relieving pressure before disconnecting hydraulic or other lines. Tighten all connections before applying pressure.
- Search for leaks with a piece of cardboard. Protect hands and body from high pressure fluids.
- If an accident occurs, see a doctor immediately. Any fluid injected into the skin must be surgically removed within a few hours or gangrene may result. Doctors unfamiliar with this type of injury should reference a knowledgeable medical source. Such information is available from Deere & Company Medical Department in Moline, Illinois, U.S.A. Information may be obtained in the United States and Canada only by calling 1-800-822-8262.

## Prevent Fires

- Machine fires and structure fires can occur if a machine is stored before allowing it to cool, or if debris is not removed from around the engine and muffler, or if stored near combustible materials.
- Remove grass and debris from engine compartment and muffler area, before and after operating machine, especially after mowing or mulching in dry conditions.
- Empty the grasscatcher completely before storing.
- Always shut off fuel when storing or transporting machine, if the machine has a fuel shutoff.
- Do not store machine near an open flame or source of ignition, such as a water heater or furnace.
- Check fuel lines, tank, cap, and fittings frequently for cracks or leaks. Replace if necessary.



## Tire Safety

Explosive separation of a tire and rim parts can cause serious injury or death:

- Do not attempt to mount a tire without the proper equipment and experience to perform the job.

- Always maintain the correct tire pressure. Do not inflate the tires above the recommended pressure. Never weld or heat a wheel and tire assembly. The heat can cause an increase in air pressure resulting in a tire explosion. Welding can structurally weaken or deform the wheel.
- When inflating tires, use a clip-on chuck and extension hose long enough to allow you to stand to one side and NOT in front of or over the tire assembly.
- Check tires for low pressure, cuts, bubbles, damaged rims or missing lug bolts and nuts.

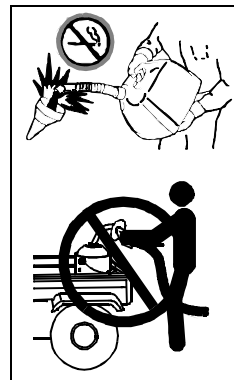

## Handling Fuel Safely

To avoid personal injury or property damage, use extreme care in handling fuel. Fuel is extremely flammable and fuel vapors are explosive:

- Extinguish all cigarettes, cigars, pipes, and other sources of ignition.
- Use only approved non-metal, portable fuel containers. If using a funnel, make sure it is plastic and has no screen or filter.
- Never remove the fuel tank cap or add fuel with the engine running. Allow engine to cool before refueling.
- Never add fuel to or drain fuel from the machine indoors. Move machine outdoors and provide adequate ventilation.
- Clean up spilled fuel immediately. If fuel is spilled on clothing, change clothing immediately. If fuel is spilled near machine, do not attempt to start the engine but move the machine away from the area of spillage. Avoid creating any source of ignition until fuel vapors have dissipated.
- Never store the machine or fuel container where there is an open flame, spark, or pilot light such as on a water heater or other appliance.
- Prevent fire and explosion caused by static electric discharge. Static electric discharge can ignite fuel vapors in an ungrounded fuel container.
- Never fill containers inside a vehicle or on a truck or trailer bed with a plastic liner. Always place containers on the ground away from your vehicle before fueling.
- Remove fuel-powered equipment from the truck or trailer and refuel it on the ground. If this is not possible, then refuel such equipment with a portable container, rather than from a fuel dispenser nozzle.
- Keep the nozzle in contact with the rim of the fuel tank or container opening at all times until the fueling is complete. Do not use a nozzle lock-open device.

# SAFETY

---

- Never overfill fuel tank. Replace fuel tank cap and tighten securely.
- Replace all fuel container caps securely after use.
- For gasoline engines, do not use gas with methanol. Methanol is harmful to your health and to the environment.

## Handling Waste Product and Chemicals

Waste products, such as, used oil, fuel, coolant, brake fluid, and batteries, can harm the environment and people:

- Do not use beverage containers for waste fluids - someone may drink from them.
- See your local Recycling Center or authorized dealer to learn how to recycle or get rid of waste products.

# OPERATING CONTROLS

## Operating Controls

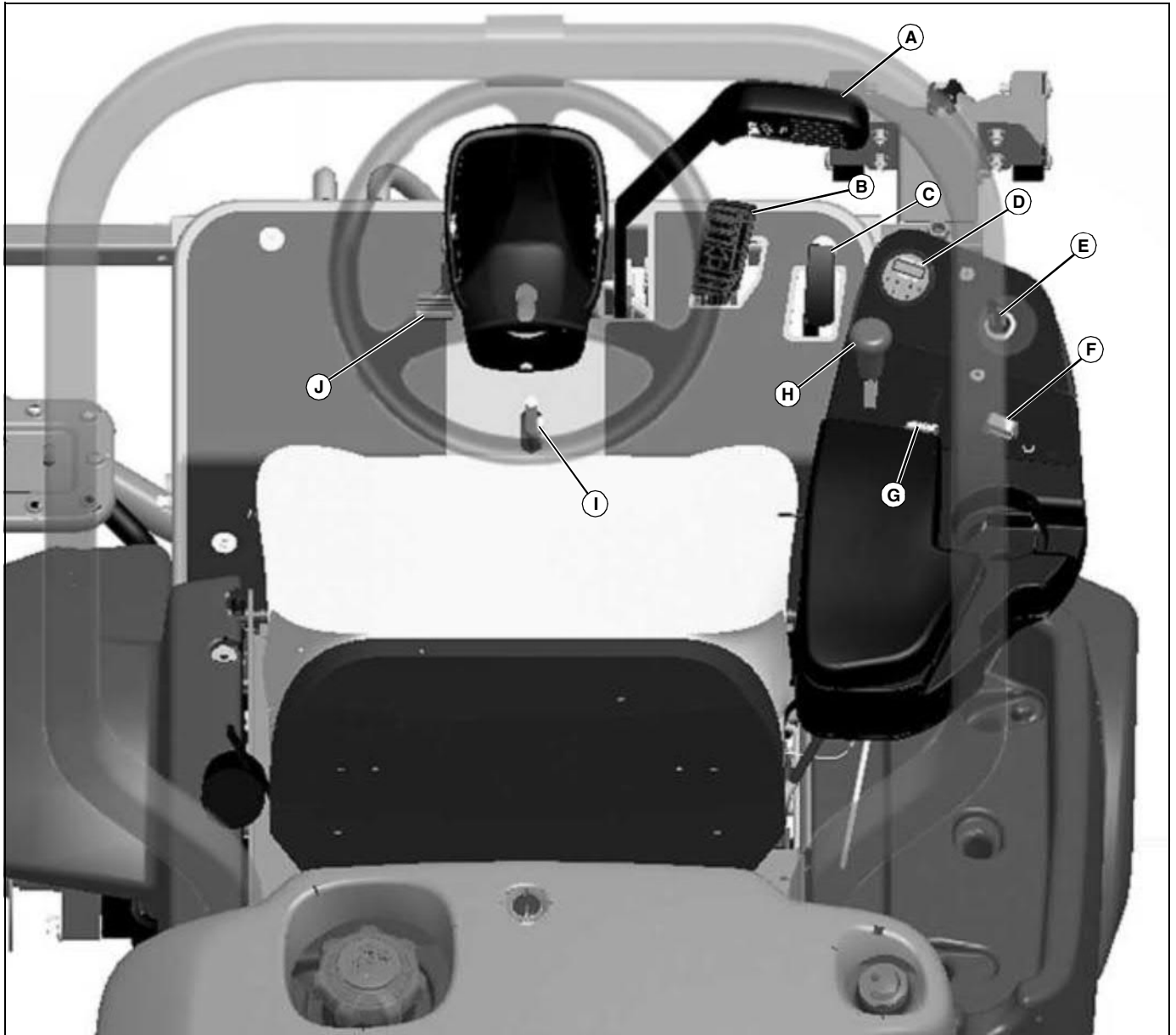

MX23373

Key	Description	Key	Description
A	Park Brake Pedal/Emergency Brake	H	Raise-Lower Lever
B	Reverse Travel Pedal	I	Park Brake Lock
C	Forward Travel Pedal	J	Tilt Steering Adjustment Lever
D	Indicator Light/Hourmeter Module		
E	Key Switch		
F	Throttle Control Lever		
G	Mow-Transport Lever		

## OPERATING CONTROLS

---

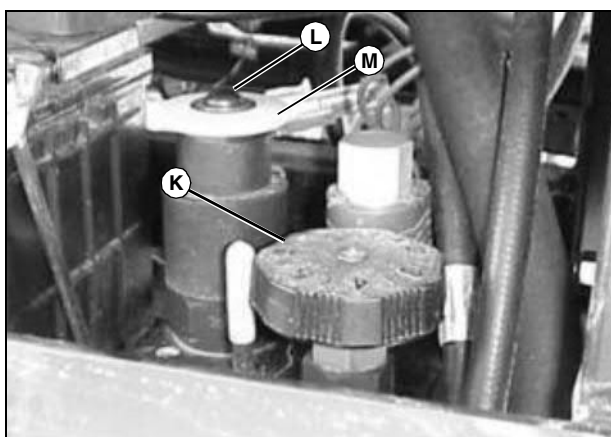

MX20450

**Picture Note: 2500B Model Shown**

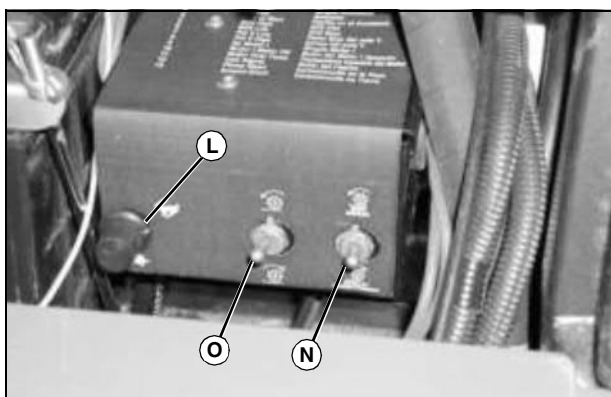

MX20429

**Picture Note: 2500E Hybrid Model Shown**

### **Key Description**

- |   |                        |
|---|------------------------|
| K | Speed Control Knob     |
| L | Release Button         |
| M | Forward-Reverse Knob   |
| N | Mow-Backlap Switch     |
| O | Forward-Reverse Switch |

# OPERATING

## Daily Operating Checklist

- Test safety systems.
- Check tire pressure.
- Check fuel level.
- Check engine oil level.
- Check hydraulic oil level.

## Avoid Damage to Plastic and Painted Surfaces

- Do not wipe plastic parts unless rinsed first.
- Insect repellent spray may damage plastic and painted surfaces. Do not spray insect repellent near machine.
- Be careful not to spill fuel on machine. Fuel may damage surface. Wipe up spilled fuel immediately.

## Adjusting Seat



**CAUTION: Avoid injury!** Installing a seat other than one designed for the machine can cause unsafe operating conditions. The seat can become loose and fail. Only install seat designed and approved for the machine by the manufacturer.

**NOTE: If needed, use the front set of holes in the seat base to provide the most rearward seat position and increased leg room.**

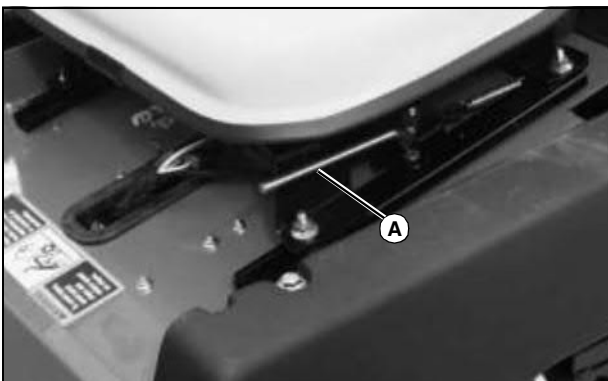

M97305

1. Sit on the seat and pull lever (A) to the left.
2. Slide seat forward or backward to desired position.
3. Release lever.

## Adjusting Tilt Steering Wheel

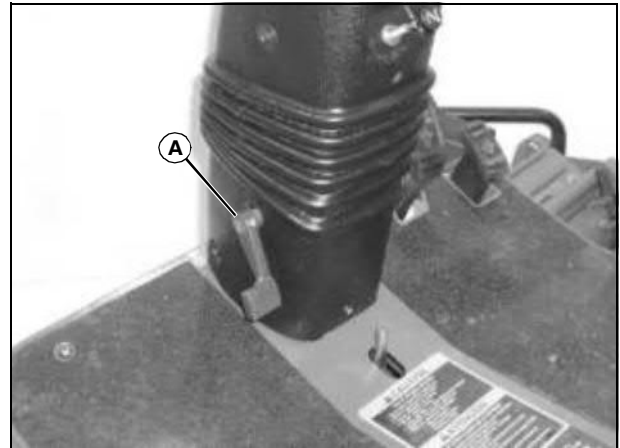

MX20345

1. Press and hold adjustment pedal (A).
2. Move steering wheel to desirable operating position.
3. Release pedal to lock steering wheel in position.

## Adjusting Mowing Speed

**NOTE: Greensmower is preset at the factory to operate at approximately 7.1 km/h (4.4 mph).**

**Wheel RPM's necessary to meet the preset mow speed specification are 178 to 192. Wheel RPM's have been preset at the factory to assure proper forward mow speed regardless of tire size.**

1. Park the vehicle safely. (See Park Safely in the SAFETY section.)

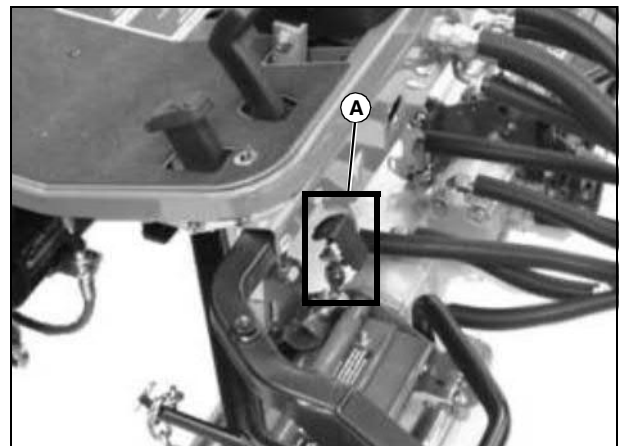

M97395

2. Locate mow speed adjustment (A).
3. Move Mow/Transport lever to the MOW position.

# OPERATING

**NOTE:** Preliminary dimension (B) between top of mow speed adjustment and bottom of forward travel pedal linkage is 22 mm (0.87 in.) When mow speed adjustments change, record any dimension (B) changes for future reference.

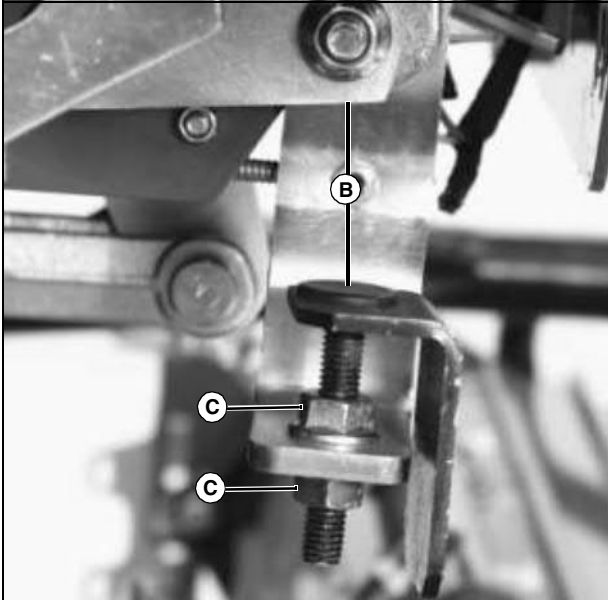

M97396

4. Loosen jam nuts (C).
5. Adjust stop dimension.
  - Increase dimension (B) for increased mowing speed.
  - Decrease dimension (B) for decreased mowing speed.
6. Tighten jam nuts.
7. Move Mow/Transport lever to the TRANSPORT position.
8. Measure off 30.5 m (100 ft.)
9. Start engine.
10. Move Mow/Transport lever to the MOW position.
11. Move throttle lever to the FAST position. Depress FORWARD travel pedal fully.
12. Record the number of seconds it takes to travel the 30.5 m (100 ft.) length.
13. Refer to applicable cutting ratio table to determine ground speed and frequency of cut.
14. Continue adjustment process until desired mowing speed and frequency of cut is achieved.

## Cutting Ratios

Ground Speed	Seconds to Travel 30.5m (100 ft)	Frequency of Cut 7 Blade	Frequency of Cut 11 Blade
4 km/h (2.5 mph)	27.2	4.37 mm (.172 in.)	2.77 mm (.109 in.)
4.8 km/h (3.0 mph)	22.7	5.23 mm (.206 in.)	3.33 mm (.131 in.)
5.6 km/h (3.5 mph)	19.5	6.1 mm (.240 in.)	3.89 mm (.153 in.)
6.4 km/h (4.0 mph)	17.0	6.98 mm (.275 in.)	4.45 mm (.175 in.)
7.2 km/h (4.5 mph)	15.2	7.85 mm (.309 in.)	4.98 mm (.196 in.)

## Using Seat Belt



**CAUTION: Avoid injury! Always wear seat belt when operating machine with a Roll-Over Protective Structure (ROPS). Do not jump from machine if machine tips.**

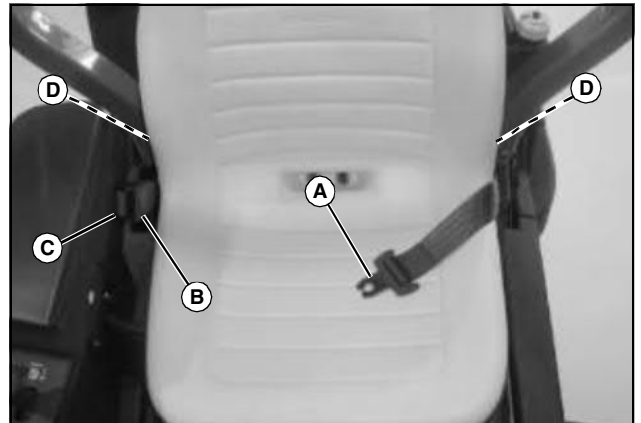

MX23604

1. Sit in seat.
2. Pull out seat belt buckle (A) and stretch across your lap in one nonstop motion.
3. Insert seat belt buckle into latch (B) until it locks.
4. To release seat belt, press red button (C) until buckle comes out of latch.
5. Tighten seat belt mounting hardware (D) to 34-47 N•m (25-35 ft-lb).

# OPERATING

## Testing Safety Systems

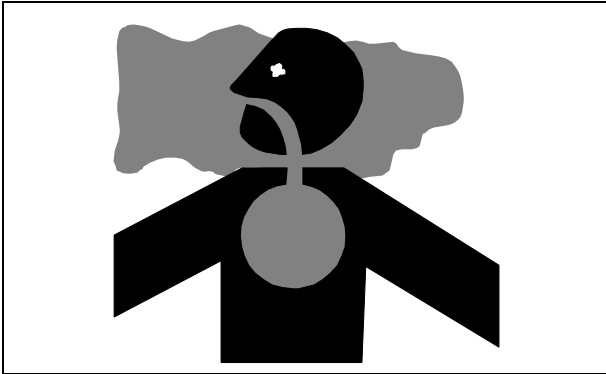

**CAUTION: Avoid injury! Engine exhaust fumes contain carbon monoxide and can cause serious illness or death.**

**Move the machine to an outside area before running the engine.**

**Do not run an engine in an enclosed area without adequate ventilation.**

- **Connect a pipe extension to the engine exhaust pipe to direct the exhaust fumes out of the area.**
- **Allow fresh outside air into the work area to clear the exhaust fumes out.**

The safety systems installed on your machine should be checked before each machine use. Be sure you have read the machine operator manual and are completely familiar with the operation of the machine before performing these safety system checks.

Use the following checkout procedures to check for normal operation of machine.

If there is a malfunction during one of these procedures, do not operate machine. **See your authorized dealer for service.**

Perform these tests in a clear open area. Keep bystanders away.

## Testing Mow-Transport Lever Switch

### Test 1

1. Sit on seat.
2. Lock the park brake.
3. Put transmission in NEUTRAL.
4. Move mow-transport lever to the MOW position.

5. Turn key switch to the START position.

**Result:** Engine must not start. The Sit-On-Seat indicator light should flash. If engine starts, there is a problem with the safety interlock circuit.

**NOTE: Move mow-transport lever to the TRANSPORT position and turn the key to the STOP position before starting engine.**

### Test 2

1. Sit on seat.
2. Lock the park brake.
3. Put transmission in NEUTRAL.
4. Rise off seat.
5. Start engine.
6. Lower cutting units to the ground.
7. Move mow-transport lever to the MOW position.

**Result:** Engine must stop within two seconds with no rotation of cutting reels. If engine does not stop, there is a problem with the safety interlock circuit.

## Testing Raise-Lower Lever Switch

1. Sit on seat.
2. Lock the park brake.
3. Move mow-transport lever to the TRANSPORT position.
4. Start engine.
5. Unlock the park brake.
6. Put the transmission in neutral.
7. Lower cutting units with the raise-lower lever.
8. Move mow-transport lever to the MOW position.

**Result:** Cutting reels must not rotate. If reels rotate, there is a problem with the safety interlock circuit.

## Testing Seat Switch

### Test 1

1. Sit on seat.
2. Lock the park brake.
3. Move mow-transport lever to the TRANSPORT position.
4. Start engine.
5. Unlock the park brake.
6. Put transmission in neutral.
7. Move mow-transport lever to the MOW position.



**Suggest:**

**If the above button click is invalid.**

**Please download this document**

**first, and then click the above link**

**to download the complete manual.**

**Thank you so much for reading**

# OPERATING



**CAUTION: Avoid injury! Blades are sharp and rotate quickly:**

- Keeps hands and feet away from cutting reels while machine is running.
- Always wear gloves while working on cutting reels.
- Watch for rotation of cutting reels. Rotating one cutting reel can cause another blade or cutting reel to rotate.

8. Push the raise-lower lever forward. Cutting reels should start rotating.

9. Rise off seat.

**Result:** Engine must stop within two seconds and reels should stop rotating. If engine does not stop, there is a problem with the safety interlock circuit.

## Test 2

1. Sit on seat.
2. Lock the park brake.
3. Start engine and set at slow idle.
4. Unlock the park brake.
5. Put the transmission in neutral.
6. Move mow-transport lever to the TRANSPORT position.
7. Rise off seat.

**Result:** Engine must stop within two seconds. If engine does not stop, there is a problem with the safety interlock circuit.

## Ignition Interlock Systems

For the starter to engage, the following conditions must be met:

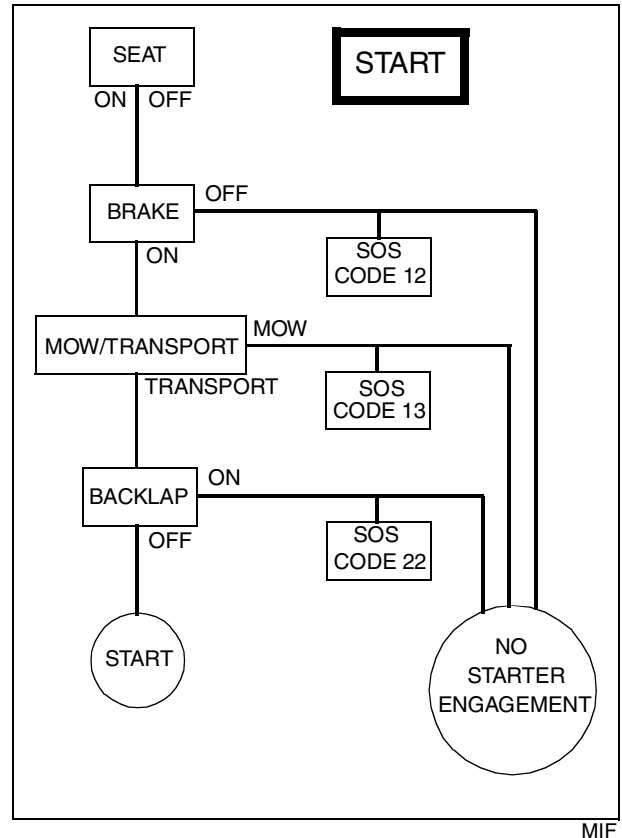

- Operator can be on or off the seat.
- Park brake locked.
- Mow/Transport lever in the TRANSPORT position.
- Backlap valve in OFF position.

**For the engine to run, the following condition must be met:**

- Operator must be on the seat or the park brake must be engaged.

If the Mow/Transport lever is in the TRANSPORT position with the park brake not engaged and the operator raises off the seat, the engine will stop.

If the Mow/Transport lever is in the MOW position with the park brake engaged and the operator raises off the seat, the engine will stop.

If the cutting reels are rotating and the operator raises off the seat, the cutting reels and engine will stop.

**<https://www.ebooklibonline.com>**

Hello dear friend!

Thank you very much for reading.

Enter the link into your browser.

The full manual is available for immediate download.

**<https://www.ebooklibonline.com>**