

# 2440 and 2640 Tractors (Serial No. 341,000- )



JOHN DEERE

## OPERATORS MANUAL 2440 and 2640 Tractors (Serial No. 341,000- )

OMR70798 Issue G0 English

John Deere Waterloo Works  
OMR70798 Issue G0

LITHO IN U.S.A. (REVISED)  
ENGLISH



## INTRODUCTION

### IMPORTANT WARRANTY INFORMATION

The warranty on this tractor appears on your copy of the purchase order which you should have received from your dealer when making your purchase. This warranty provides you the assurance that John Deere will back its products where defects appear within the warranty period. In some circumstances, John Deere also provides field improvements, often without charge to the customer, even if the product is out of warranty.

Warranty and field improvements are a part of John Deere's product support program for customers who operate and maintain their equipment as described in this manual. Should the equipment be abused, or modified to change its performance beyond the original factory specifications, the warranty will become void and field improvements may be denied. Setting fuel delivery above specifications or otherwise overpowering machines will result in such action.



This safety alert symbol indicates important safety messages in this manual. When you see this symbol, be alert to the possibility of personal injury and carefully read the message that follows.



Worldwide symbols are used to assist identification and operation. In this manual, an identifying symbol is placed by the instructions like the example at left for the symbol on the engine oil pressure gauge. The cylinder block in the symbol represents the engine, the drop signifies oil, and the arrows indicate pressure. Regardless of the language used in a nation, this symbol means engine oil pressure without translation.

This operator's manual contains SI Metric equivalents which follow immediately after the U.S. customary units of measure.

"Right-hand" and the "left-hand" sides of the tractor are determined by facing in the direction of tractor forward travel.

Record your tractor serial numbers on page 138. Provide this information to your dealer when ordering parts.

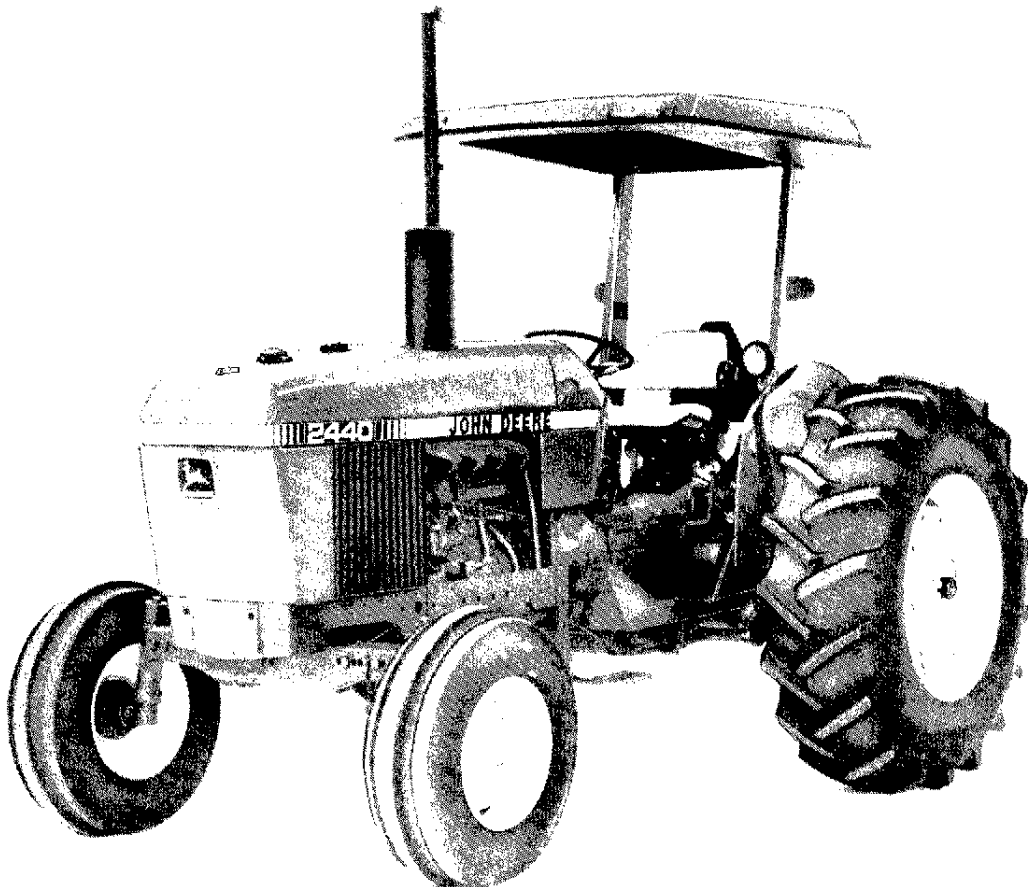

R79171X1

John Deere 2440 Tractor



# Contents

---

Safety .....	2
Controls and Instruments .....	5
Operator's Station .....	9
Engine Break-in .....	11
Prestarting Checks .....	12
Operating the Engine .....	14
Operating the Tractor .....	22
Rockshaft and Three-Point Hitch .....	28
Remote Hydraulic Cylinders .....	47
Drawbar and PTO .....	58
Ballast .....	69
Wheels, Tires, and Tread .....	75
Transporting .....	88
Lighting and Signals .....	91
Fuels and Lubricants .....	94
Lubrication and Maintenance .....	96
Service .....	107
Storage .....	128
Trouble Shooting .....	131
Specifications .....	136
Index .....	139
Daily Maintenance .....	147
Lubrication and Maintenance Record .....	147

**<https://www.ebooklibonline.com>**

Hello dear friend!

Thank you very much for reading.

Enter the link into your browser.

The full manual is available for immediate download.

**<https://www.ebooklibonline.com>**



# Safety

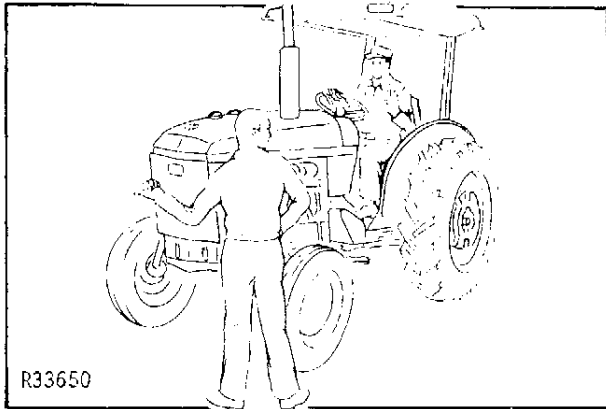

## Operate Tractor Safely

Never allow riders on the tractor.

Slow down for hillsides, rough ground, and sharp turns. Couple the brake pedals together before driving at transport speeds.

To avoid exhaust gas hazards, never run the engine in a closed building.

## Stay Clear of Moving Tractor

Never try to get on or off a moving tractor.

Before dismounting, lock the brakes and lower implements to the ground. If tractor is to be left unattended, stop the engine and remove the key.

Never attempt to start or operate the tractor except from the operator's station.

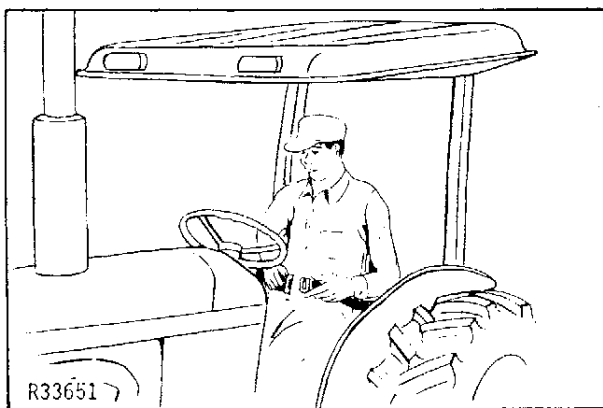

## Avoid Tip-Overs

If your tractor is equipped with a ROLL-GARD\* protective frame, use the seat belt under almost all operating conditions.

Use of seat belt is not recommended for tractors without a rollover protective device.

Avoid holes, ditches, etc. which may cause the tractor to tip, especially on hillsides.

Never drive near the edge of a gully or steep embankment—it might cave in.

Driving forward out of a ditch or mired condition or up a steep slope could cause tractor to tip over rearward.

Back out of these situations if possible.

Hitch towed loads only to the drawbar. When using a chain, take up the slack slowly.

Never modify structural members of ROLL-GARD protective frames by welding, bending, drilling, grinding, or cutting, because this may weaken the structure. If any component is damaged, replace it. Do not attempt repairs.

If ROLL-GARD protective equipment is loosened or removed for any reason, make certain all parts are reinstalled correctly. Tighten mounting bolts to proper torque, see page 127.

### Transport Safely

Never tow the tractor faster than 15 mph (24 km/h).

Before descending a steep hill, shift to a low gear to control the tractor with little or no braking. Never coast downhill.

A towed load of more than twice the weight of the tractor should have brakes. If it does not, drive slowly and avoid hills. Avoid hard applications of the brakes when pulling heavy loads.

When operating the tractor on a road, turn the light switch to the "H1" or "H2" position. Be sure the SMV emblem is visible and clean.

Always dim the headlights before meeting another vehicle. Keep the lights adjusted so they will not blind another driver.

Be sure lighting conforms to local regulations.

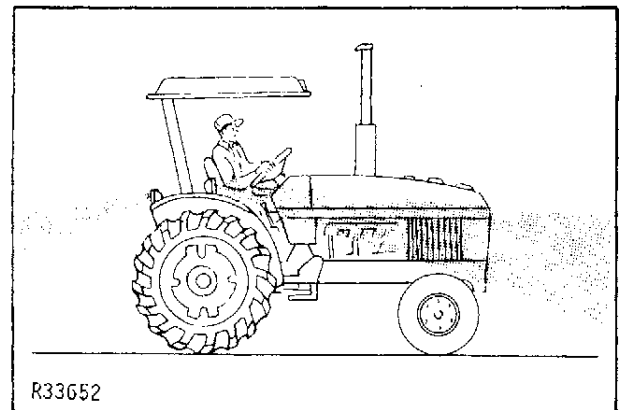

### Stay Clear of PTO

Stop the engine and be sure the PTO has stopped before:

- Connecting or disconnecting a PTO shaft
- Making any adjustment to PTO drive train or hitch
- Cleaning out PTO driven equipment.

PTO master shield should be in place at all times except for special applications as directed in the operator's manual.

The PTO shaft guard should be in place when the PTO is not being used.

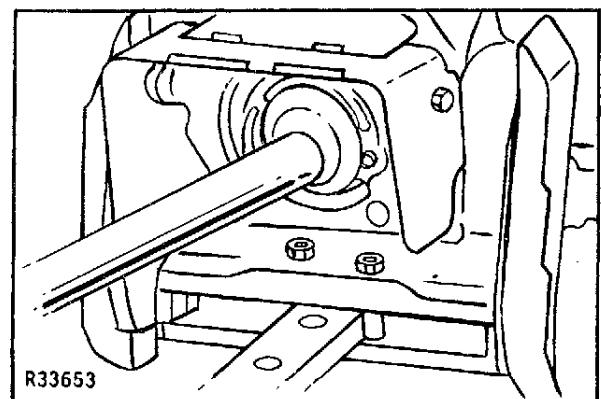

### Avoid Exhaust Fumes

Do not operate engine inside a closed building.

If a ROLL-GARD canopy is installed, also install an exhaust extension.

A horizontal exhaust system is available for applications where a vertical exhaust would be in the way. See your John Deere dealer.

### Handle Chemicals Properly

When using agricultural chemicals, follow the instructions given in the implement operator's manual and those given by the chemical manufacturer.

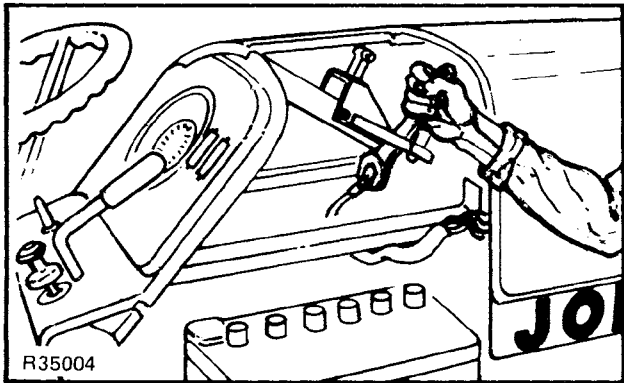

### Service Tractor Safely

Do not service the tractor while it is in motion or while the engine is running.

Disconnect the battery ground cable(s) before working on the electrical system or working in any area where you might accidentally contact electrical components.

### Avoid Explosions or Fire

Before using booster batteries, read the instructions on page 19. Before connecting or disconnecting a battery charger, turn the charger off to avoid sparks.

Be careful with any type of fuel. Do not refuel the tractor when the engine is hot or running. Never smoke while handling fuel.

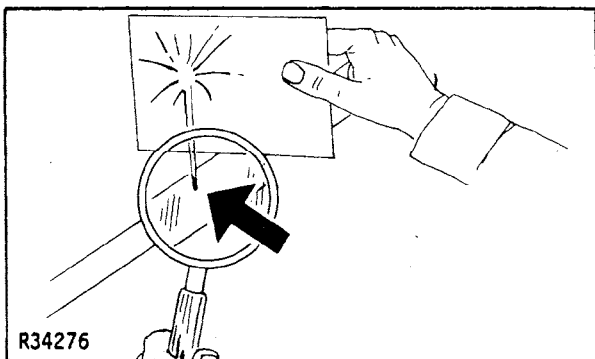

Pin Hole Leak

### Avoid High-Pressure Fluids

Do not remove the radiator cap when the engine is hot. Shut the engine off and wait until it cools. Then turn the cap to the first stop to relieve pressure before removing it completely.

Hydraulic oil or diesel fuel escaping under pressure can penetrate the skin, causing serious injury. Before disconnecting lines, be sure to relieve all pressure. Before applying pressure, be sure all connections are tight and all components are in good condition.

Fluid escaping from a very small hole can be almost invisible. Use a piece of cardboard, rather than hands, to search for suspected leaks.

If injured by escaping fluid, see a doctor at once. Serious infection or reaction can develop if proper medical treatment is not administered immediately.



### Protect Against Noise

Prolonged exposure to loud noise can cause impairment or loss of hearing.

Wear a suitable hearing protective device such as earmuffs (A) or earplugs (B) to protect against objectionable or uncomfortable loud noises.

- A—Earmuffs
- B—Earplugs



# Controls and Instruments

## CONTROLS

	See Page
1—Starting Fluid Adapter .....	17
2—Light Switch .....	91
3—Reverser or Hi-Lo Lever .....	24
4—Steering Wheel .....	
5—Speed-Hour Meter .....	6
6—Fuel Gauge .....	8
7—Engine Temperature Gauge .....	7
8—Function Indicators .....	7
9—Hand Throttle .....	20
10—Engine Stop Knob .....	21
11—Key Switch .....	16
12—Brake Pedals .....	22
13—Rockshaft Control Lever .....	29
14—Remote Cylinder Levers .....	50
15—Foot Throttle .....	20
16—Rockshaft Selector Lever .....	31
17—Gear Shift Lever .....	24
18—Range Shift Lever .....	24
19—Differential Lock Pedal .....	27
20—PTO Selector Lever .....	64
21—Differential Lock Lever .....	27
22—Clutch Pedal .....	25
23—Handbrake .....	23
24—Independent PTO Lever .....	67

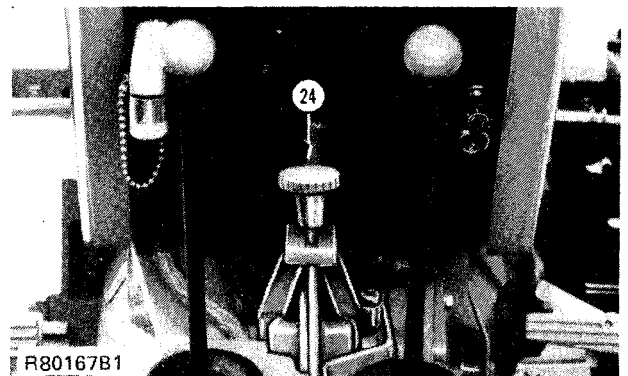
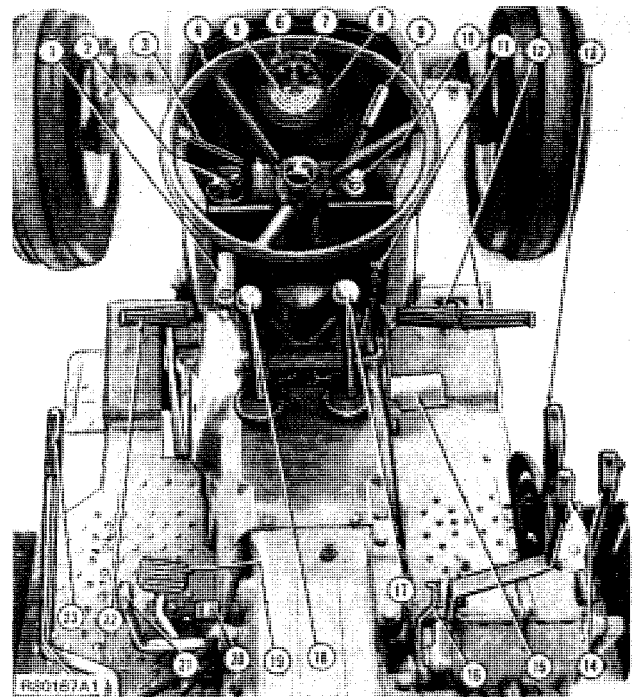

## INSTRUMENTS

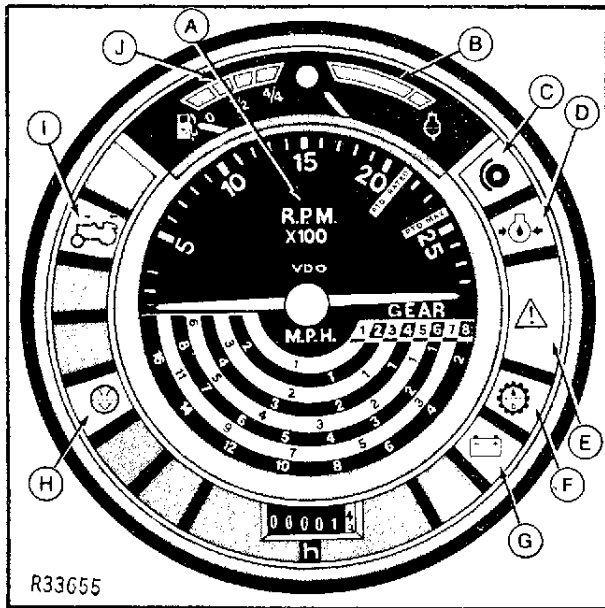

### Check Instruments Often

Leave key switch on while operating tractor so instruments will function. Check indicator lamps each time engine is started to be sure they work.

- A—Speed-Hour Meter
- B—Engine Temperature Gauge
- C—Handbrake Indicator
- D—Engine Oil Pressure Indicator
- E—Attention Indicator
- F—Transmission Oil Pressure Indicator (Hi-Lo Tractor Only)
- G—Alternator Indicator
- H—Air Cleaner Restriction Indicator
- I—Warning Lamp Indicator
- J—Fuel Gauge

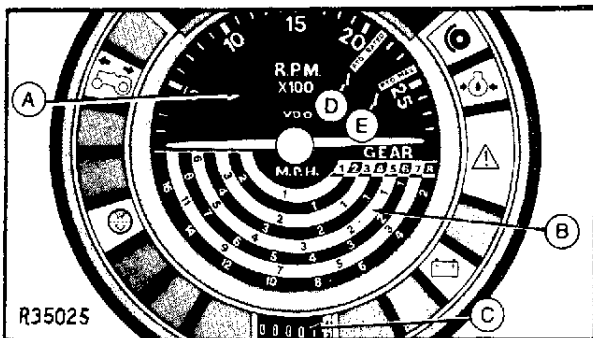

### Speed-Hour Meter (Without Hi-Lo)

The speed-hour meter shows engine speed in rpm (A), and hours of operation in full hours and tenths (C). It also shows travel speed in the gear engaged (B).

On tractors without HI-LO transmission, keep engine speed between 1500 and 2500 rpm for most work. Align needle with "PTO Rated" mark (D) (2100 rpm) for standard PTO speed.

"PTO Max" mark (E) at 2400 rpm indicates a 10 percent PTO overspeed.

**IMPORTANT:** Never exceed 2400 rpm when PTO is engaged.

- A—Engine Speed
- B—Travel Speed
- C—Hour-Meter
- D—PTO Rated Mark
- E—PTO Max Mark

### Speed-Hour Meter (With Hi-Lo)

The speed-hour meter shows engine speed in rpm (A), and hours of operation in full hours and tenths (C). It also shows travel speed in the gear engaged (B).

On tractors with HI-LO transmission, keep engine speed between 1500 and 2500 rpm for most work. Align needle with PTO mark (D) (2400 rpm) for standard PTO speed.

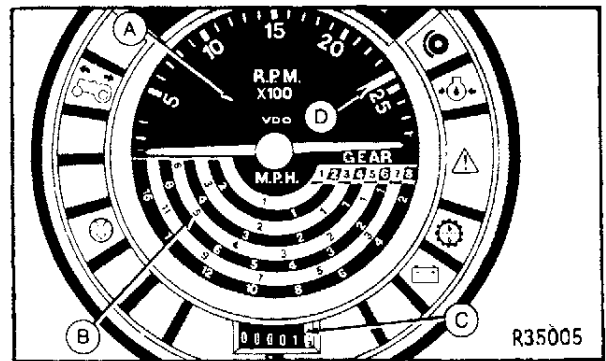

- A—Engine Speed
- B—Travel Speed
- C—Hour-Meter
- D—PTO Mark

### Engine Temperature Gauge

Green band represents normal operating temperature range. If gauge reaches red area, stop tractor and determine cause. Check grille screens and radiator for plugging. Reduce load or shift to a lower gear. See page 25.

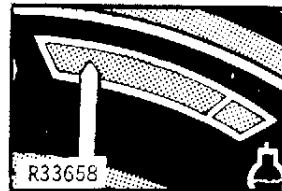

### Handbrake Indicator

Handbrake indicator will glow any time handbrake is engaged. Indicator will glow and warning horn will sound when handbrake is engaged and range lever is placed in gear.

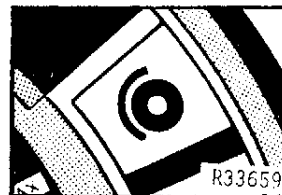

### Engine Oil Pressure Indicator

Indicator glows if engine oil pressure falls too low. Stop engine and determine cause. If low oil level is not the cause, see your John Deere dealer. NEVER operate an engine with low oil pressure - not even for a minute.

*NOTE: Air cleaner restriction indicator will also glow.*

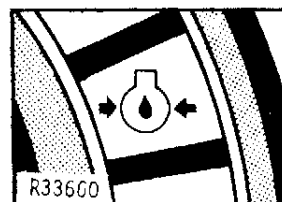

### Transmission Oil Pressure Indicator

On Hi-Lo equipped tractors, indicator will glow if transmission oil pressure falls too low. A plugged filter is probably the cause; replace it. See page 101. If indicator continues to glow, see your John Deere dealer.

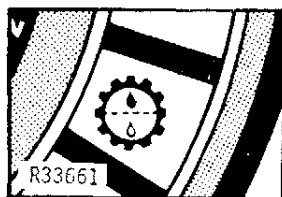

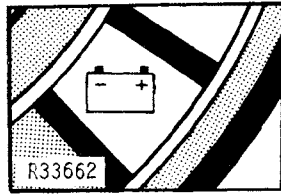

### Alternator Indicator

If alternator output becomes insufficient, indicator will glow. Check fan belt tension, see page 112.

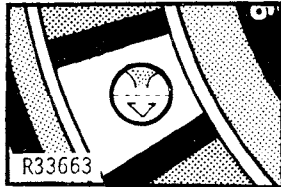

### Air Cleaner Restriction Indicator

Service air cleaner if indicator glows while engine is running. See page 109.

*NOTE: Indicator will also glow if engine oil pressure indicator comes on.*

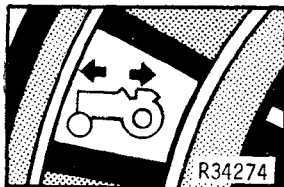

### Warning Lamp Indicator

Whenever warning lamps are on, indicator will blink.

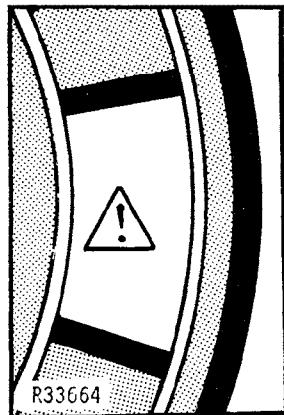

### Attention Indicator

If engine oil pressure, transmission oil pressure or alternator indicator glows for more than two seconds, the attention indicator will begin to flash.

If handbrake is engaged and range shift lever is placed into gear, attention indicator will flash after a two second delay.

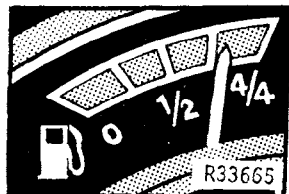

### Fuel Gauge

Stop to refuel before fuel gauge reaches empty mark. Do not allow a diesel engine to run out of fuel. Fuel requirements are given on page 94.



# Operator's Station

## SEAT

Seat cushion can be raised to permit standing or to protect upholstery when tractor is not in use.

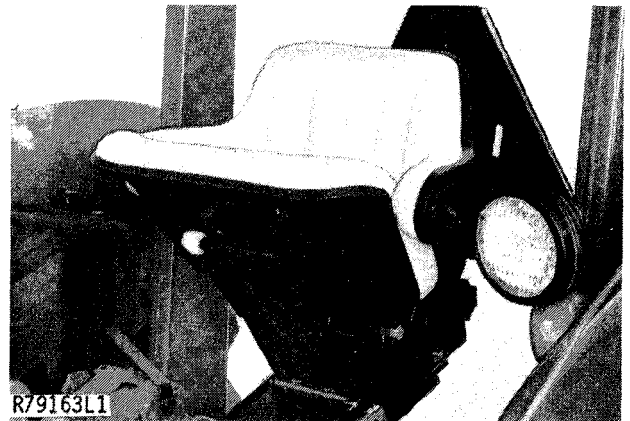

## Weight Adjustment

1. Turn weight adjusting knob (A) to set weight indicator (B) at operator weight on weight scale (C).
2. With operator in seat, use weight adjusting knob to align pointers (D). This provides full vertical range of travel.

A—Weight Adjusting Knob  
 B—Indicator  
 C—Weight Scale  
 D—Pointers

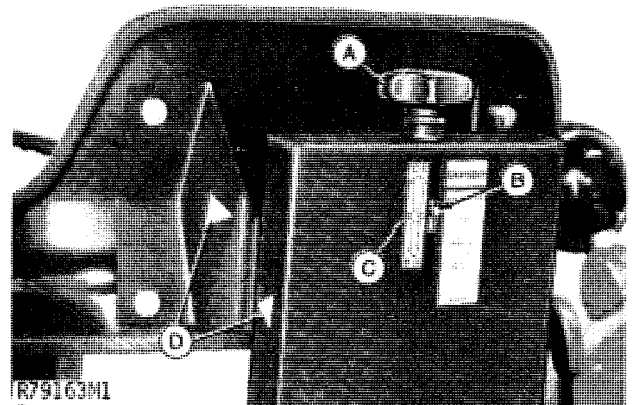

*Continued on next page*

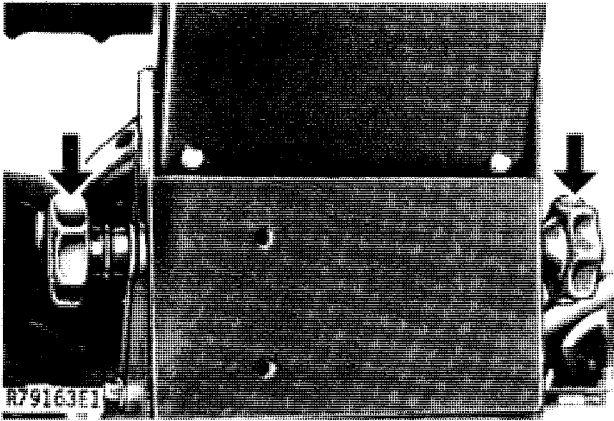

### Height Adjustment

1. Loosen locking knobs.
2. Raise or lower seat to desired height.
3. Tighten locking knobs.

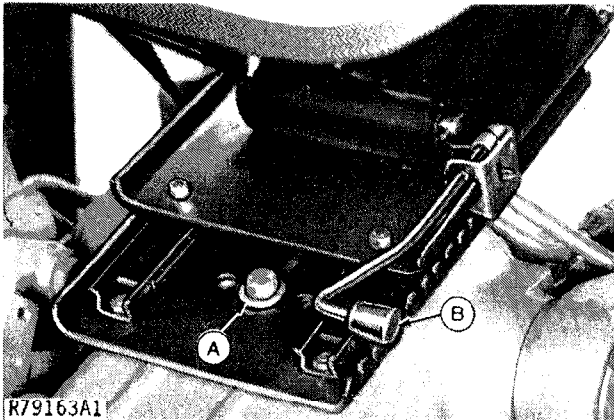

### Fore-And-Aft Adjustment

1. Lift lever (B) and slide seat forward or backward. Release lever.
2. For additional travel, loosen two bolts (A) holding seat assembly to tractor. Slide assembly to desired position and tighten bolts.

A—Seat Assembly Bolt  
B—Lever

## SEAT BELT

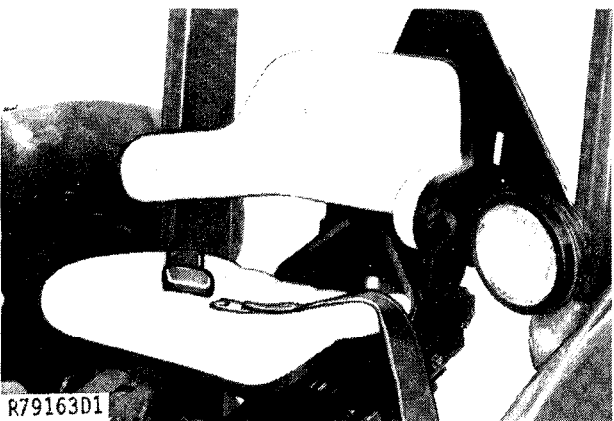

**CAUTION:** If tractor is equipped with a ROLL-GARD protective frame, use the seat belt under almost all operating conditions.

Use of a seat belt is not recommended for tractors without a rollover protective device.



# Engine Break-in

The engine is ready for normal operation. However, you should be extra cautious during the first 100 hours.

1. Avoid unnecessary engine idling. If tractor will be idle longer than five minutes, stop the engine.
2. Watch engine temperature gauge closely. If needle rises into red area, shift to a lower gear or reduce load. Unless temperature quickly drops, stop the engine and determine the cause.
3. Check engine oil and coolant levels more frequently. Watch for any signs of leaks.
4. Follow break-in lubrication instructions on page 96.
5. Until you become thoroughly familiar with the sound and feel of your new tractor, stay extra attentive and alert.

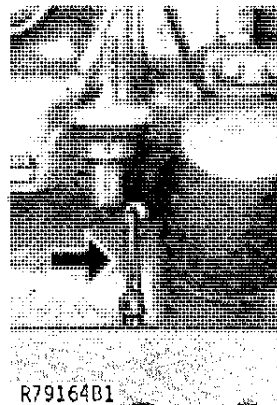
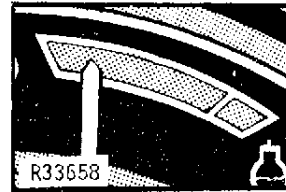

Engine Oil Dipstick

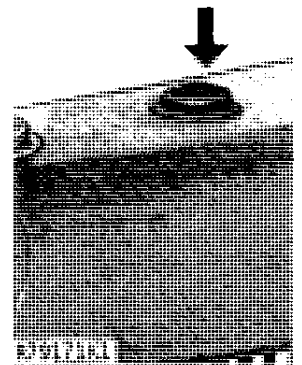

Radiator Cap



# Prestarting Checks

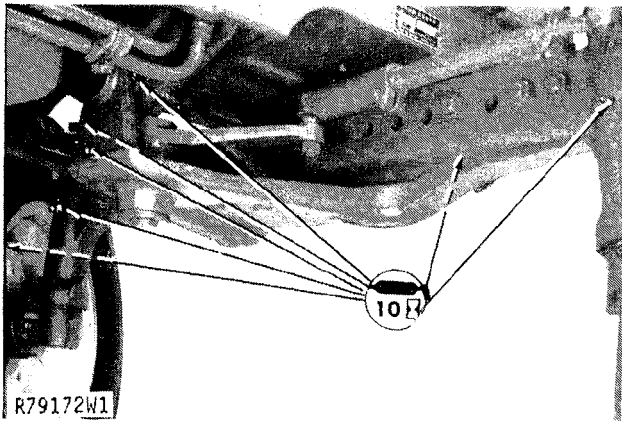

Do the following before starting the engine for the first time each day.

1. Lubricate drag link ends, front wheel spindles, front axle pivot pins and bell crank bearing.

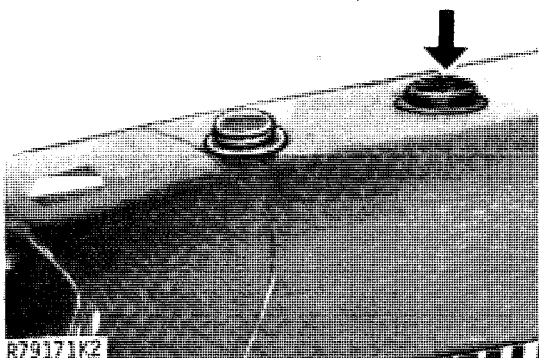

2. Check the coolant level. It must be midway between filler neck and top of radiator core.

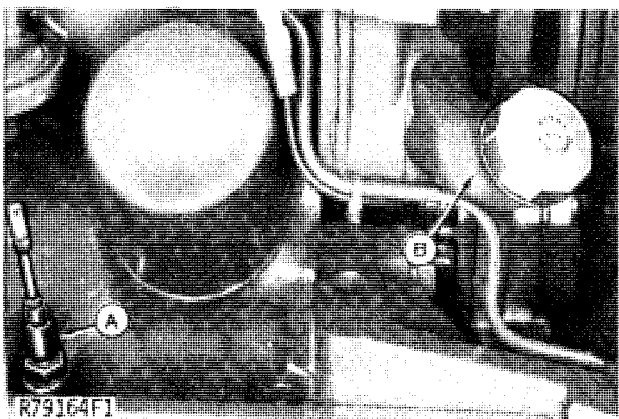

3. Check the engine oil level. Do not operate engine when oil level is below add mark on dipstick. See page 95 for oil specifications.

A—Dipstick  
B—Crankcase Filler

4. Check fuel filter. If water or sediment is present, remove it. See page 106.

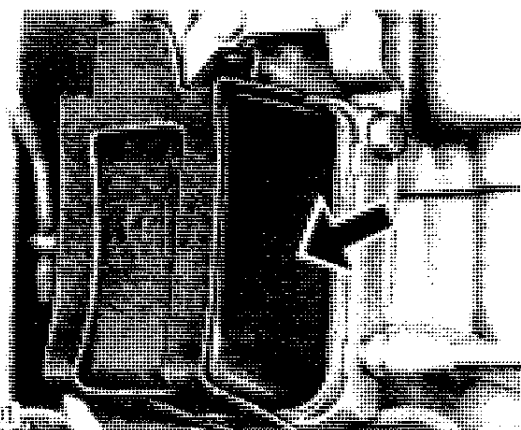

R79164D1



# Operating the Engine

## STARTING THE ENGINE



**CAUTION:** Before starting engine, be sure there is plenty of ventilation.

*NOTE:* If temperature is below 40°F (5°C), it may be necessary to use a cold weather starting aid. See page 17.

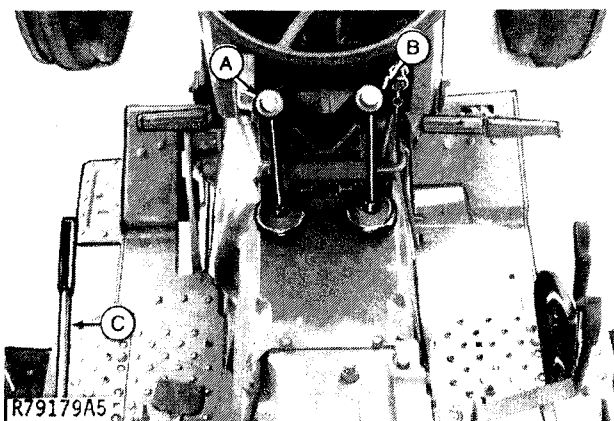

1. Be sure handbrake (C) is set, then place gear shift (B) and range shift (A) levers in neutral.

A—Range Shift Lever  
B—Gear Shift Lever  
C—Handbrake



Rockshaft Control Lever

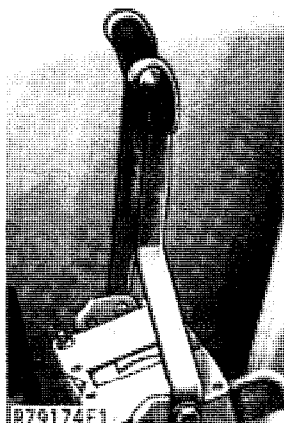

Remote Cylinder Levers

2. Be sure rockshaft control lever is in lowered position and remote cylinder levers are in neutral.

3. If equipped with PTO selector lever, place it in disengage position.

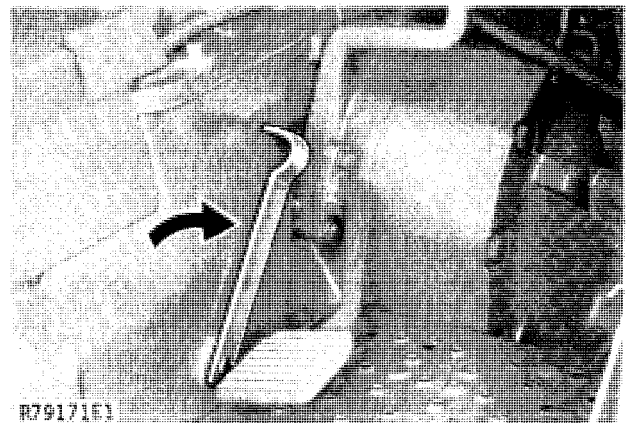

4. Engine stop knob must be pushed all the way in.

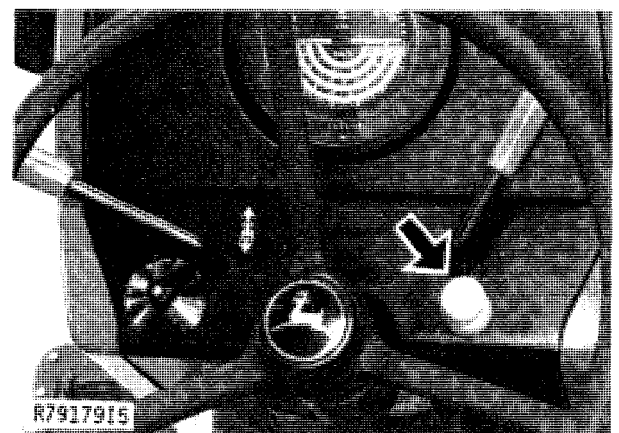

5. Set hand throttle approximately 1/4 of the way downward (approximately 1200 rpm position).

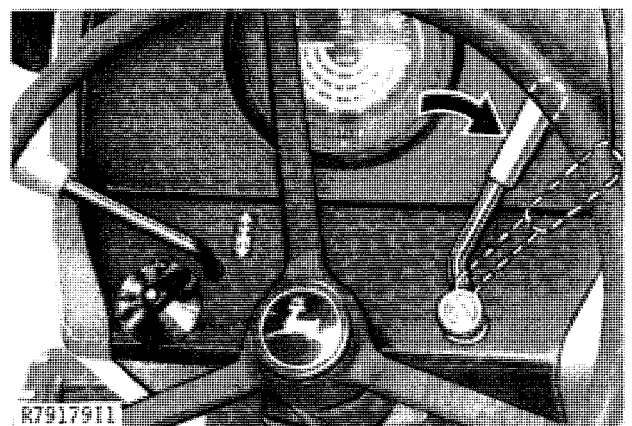

6. Depress clutch pedal.

**⚠ CAUTION: Start engine only from operator's seat. NEVER start engine while standing on ground.**

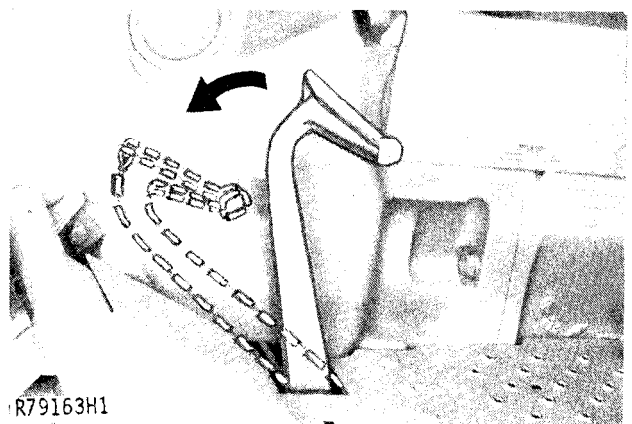

Continued on next page



**Suggest:**

**If the above button click is invalid.**

**Please download this document**

**first, and then click the above link**

**to download the complete manual.**

**Thank you so much for reading**

16 Operating the Engine

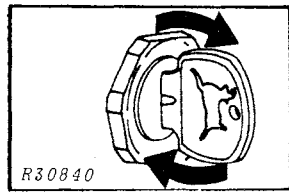

7. Turn key to first position.

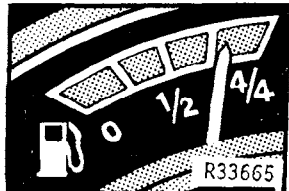

8. Check fuel gauge to be sure tractor has plenty of fuel.

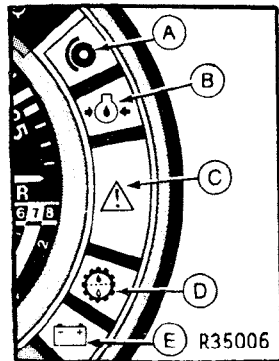

9. Check instrument cluster. Handbrake (A), engine oil pressure (B), and alternator (E), indicators should glow.

Attention indicator (C) should blink after a two second delay.

On Hi-Lo equipped tractors, transmission oil pressure indicator (D) should also glow after a two second delay.

- A—Handbrake Indicator
- B—Engine Oil Pressure Indicator
- C—Attention Indicator
- D—Transmission Oil Pressure Indicator
- E—Alternator Indicator

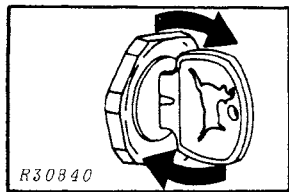

10. Turn key switch farther clockwise to engage starter. Release key when engine starts. If key is released before engine starts, wait until starter and engine stop turning before trying again.

**IMPORTANT:** Do not operate starter more than 30 seconds at a time. If engine does not start, wait at least two minutes before trying again. If engine does not start in four attempts, refer to "Trouble Shooting", page 131.

**<https://www.ebooklibonline.com>**

Hello dear friend!

Thank you very much for reading.

Enter the link into your browser.

The full manual is available for immediate download.

**<https://www.ebooklibonline.com>**