

JOHN DEERE
WORLDWIDE COMMERCIAL & CONSUMER
EQUIPMENT DIVISION

Compact Utility Tractors
2305

OMLVU23228 B0

OPERATOR'S MANUAL



JOHN DEERE

⚠ WARNING: Diesel engine exhaust and some of its constituents are known to the State of California to cause cancer, birth defects, and other reproductive harm.

California Proposition 65 Warning

North American Version
Litho in U.S.A.

INTRODUCTION

Thank You for Purchasing a John Deere Product

We appreciate having you as a customer and wish you many years of safe and satisfied use of your machine.

Using Your Operator's Manual

This manual is an important part of your machine and should remain with the machine when you sell it.

Reading your operator's manual will help you and others avoid personal injury or damage to the machine. Information given in this manual will provide the operator with the safest and most effective use of the machine. Knowing how to operate this machine safely and correctly will allow you to train others who may operate this machine.

If you have an attachment, use the safety and operating information in the attachment operator's manual along with the machine operator's manual to operate the attachment safely and correctly.

This manual and safety signs on your machine may also be available in other languages (see your authorized dealer to order).

Sections in your operator's manual are placed in a specific order to help you understand all the safety messages and learn the controls so you can operate this machine safely. You can also use this manual to answer any specific operating or servicing questions. A convenient index located at the end of this book will help you to find needed information quickly.

The machine shown in this manual may differ slightly from your machine, but will be similar enough to help you understand our instructions.

RIGHT-HAND and LEFT-HAND sides are determined by facing in the direction the machine will travel when going forward. When you see a broken line (-----), the item referred to is hidden from view.

Before delivering this machine, your dealer performed a predelivery inspection to ensure best performance.

Special Messages

Your manual contains special messages to bring attention to potential safety concerns, machine damage as well as helpful operating and servicing information. Please read all the information carefully to avoid injury and machine damage.



CAUTION: Avoid injury! This symbol and text highlight potential hazards or death to the operator or bystanders that may occur if the hazards or procedures are ignored.

IMPORTANT: Avoid damage! This text is used to tell the operator of actions or conditions that might result in damage to the machine.

NOTE: General information is given throughout the manual that may help the operator in the operation or service of the machine.

Attachments for Your Machine

There's a John Deere attachment or kit to make your new machine perform more tasks or be more versatile, whether your machine is a lawn tractor or compact utility tractor or a utility vehicle.

You can check out the entire line of attachments for your machine at JohnDeere.com or ask your John Deere dealer. From aerators to electric lift kits to tillers, there's a John Deere attachment or kit to fill every need.

PRODUCT IDENTIFICATION

Record Identification Numbers

Compact Utility Tractor

2305 PIN (120001-)

If you need to contact an Authorized Service Center for information on servicing, always provide the product model and identification numbers.

You will need to locate the identifications numbers for the product. Record the information in the spaces provided below.

DATE OF PURCHASE:

DEALER NAME:

DEALER PHONE:

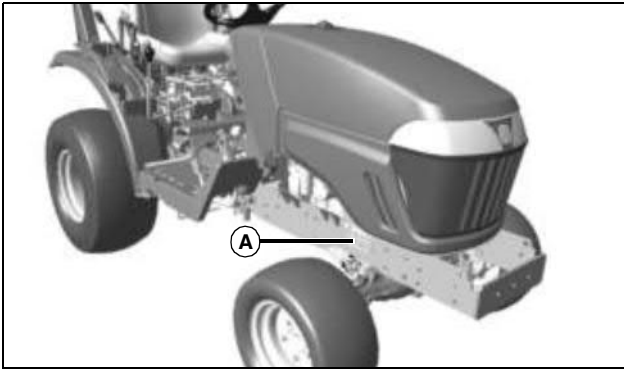

MX35612

PRODUCT IDENTIFICATION NUMBER (A):

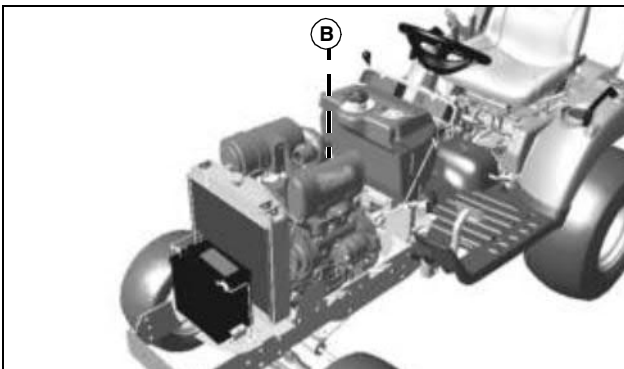

MX35610

ENGINE SERIAL NUMBER (B):

<https://www.ebooklibonline.com>

Hello dear friend!

Thank you very much for reading.

Enter the link into your browser.

The full manual is available for immediate download.

<https://www.ebooklibonline.com>

TABLE OF CONTENTS

Safety Labels	1
Safety	5
Operating Controls	10
Operating	11
Replacement Parts	31
Service Intervals	32
Service Lubrication	34
Service Engine	36
Service Transmission	45
Service Electrical	49
Service Miscellaneous	54
Troubleshooting	59
Storage	64
Specifications	65
Warranty	69
Index	72

Original Instruction

All information, illustrations and specifications in this manual are based on the latest information at the time of publication. The right is reserved to make changes at any time without notice.

COPYRIGHT© 2010

Deere & Co.

John Deere Worldwide Commercial and Consumer Equipment Division

All rights reserved

Previous Editions

COPYRIGHT©

OMLVU23228 B0 - English

SAFETY LABELS

Safety Label Location

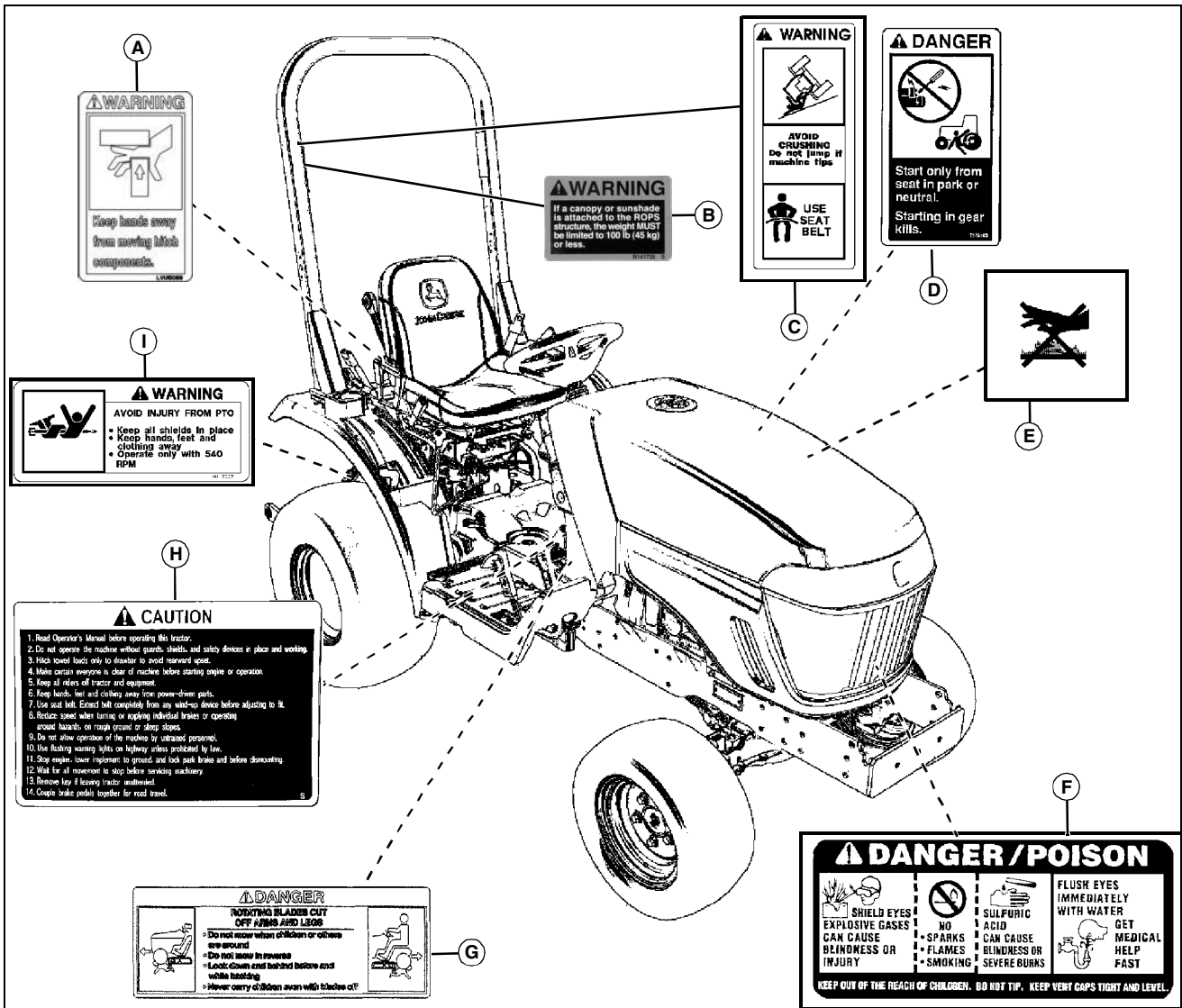

MX42026

Picture Note: Use label number listed in table below to locate complete text of safety label message following this illustration.

- A - WARNING LVU15089**
- B - WARNING R141735**
- C - WARNING M76637**
- D - DANGER T146103**
- E - CAUTION HOT SURFACE (embossed on muffler)**
- F - DANGER/POISON M88249**
- G - DANGER LVU14509**
- H - CAUTION LVU801732**
- I - WARNING M117557**



Understanding The Machine Safety Labels

The machine safety labels shown in this section are placed in important areas on your machine to draw attention to potential safety hazards.

On your machine safety labels, the words DANGER, WARNING, and CAUTION are used with this safety-alert symbol. DANGER identifies the most serious hazards.

The operator's manual also explains any potential safety hazards whenever necessary in special safety messages that are identified with the word, CAUTION, and the safety-alert symbol.

There can be additional safety information contained on parts and components sourced from suppliers that is not reproduced in this operator's manual.

SAFETY LABELS

WARNING - LVU15089



LVU15089

- Keep hands away from moving hitch components.

WARNING - M76637

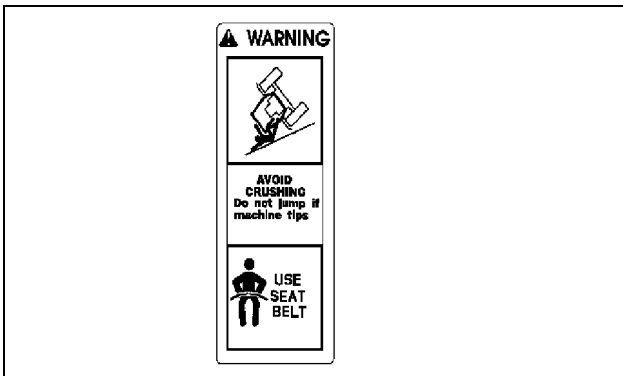

M76637

- AVOID CRUSHING
- Do not jump if machine tips
- USE SEAT BELT

DANGER T146103



T146103

Start only from seat in park or neutral.

Starting in gear kills.

WARNING M117557

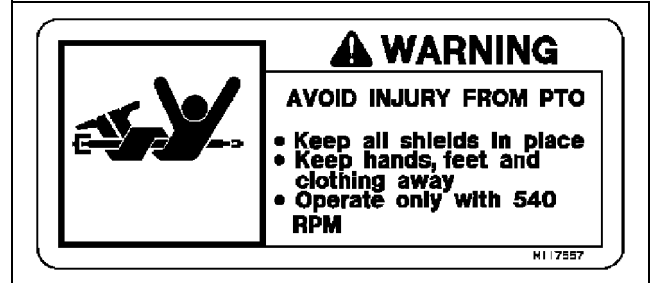

M117557

AVOID INJURY FROM PTO.

- Keep all shields in place.
- Keep hands, feet and clothing away.
- Operate only with 540 RPM.

WARNING ROPS R141735



R141735

Picture Note: Located on inside of right side of ROPS.

If a canopy or sunshade is attached to the ROPS structure, the weight **MUST** be limited to 100 lb (45 kg) or less.

SAFETY LABELS

CAUTION - LVU801732

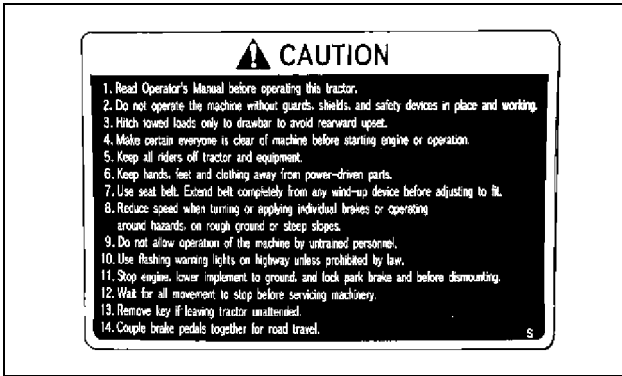

LVU801732

1. Read Operator's Manual before operating this tractor.
2. Do not operate the machine without guards, shields, and safety devices in place and working.
3. Hitch towed loads only to drawbar to avoid rearward upset.
4. Make certain everyone is clear of machine before starting engine or operation.
5. Keep all riders off tractor and equipment.
6. Keep hands, feet and clothing away from power-driven parts.
7. Use seat belt. Extend belt completely from any wind-up device before adjusting to fit.
8. Reduce speed when turning or applying individual brakes or operating around hazards, on rough ground or steep slopes.
9. Do not allow operation of the machine by untrained personnel.
10. Use flashing warning lights on highway unless prohibited by law.
11. Stop engine, lower implement to ground, and lock park brake before dismounting.
12. Wait for all movement to stop before servicing machinery.
13. Remove key if leaving tractor unattended.
14. Couple brake pedals together for road travel.

DANGER - LVU14509

ROTATING BLADES CUT OFF ARMS AND LEGS

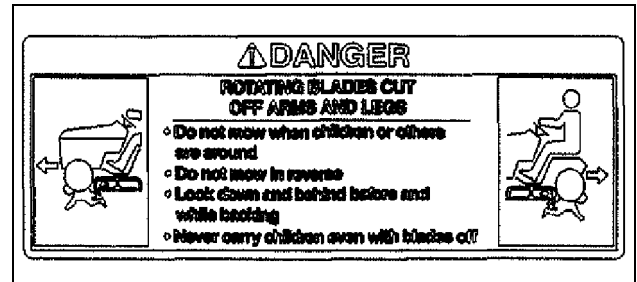

LVU14509

- Do not mow when children or others are around.
- Do not mow in reverse.
- Look down and behind before and while backing.
- Never carry children even with blades off.

DANGER / POISON

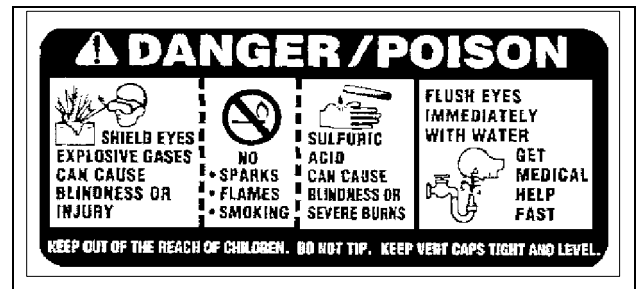

M88249

Picture Note: Located on battery.

SHIELD EYES: EXPLOSIVE GASES CAN CAUSE BLINDNESS OR INJURY.

NO SPARKS, FLAMES, SMOKING.

SULFURIC ACID CAN CAUSE BLINDNESS OR SEVERE BURNS.

FLUSH EYES IMMEDIATELY WITH WATER. GET MEDICAL HELP FAST.

KEEP OUT OF THE REACH OF CHILDREN. DO NOT TIP. KEEP VENT CAPS TIGHT AND LEVEL.

SAFETY LABELS

CAUTION

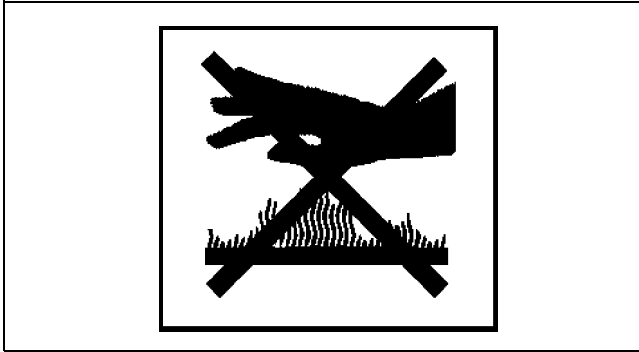

MIF

Picture Note: Molded onto muffler.

No-text warning: Hot Surface.

- Do not touch engine muffler, it may be hot.

CAUTION iMatch™ Quick-Hitch LVU13502



LVU13502

Picture Note: Optional iMatch Quick-Hitch.

BEFORE USING, SECURE TRACTOR IMPLEMENT WITH BOTH LOCKING LUGS OVER LOWER IMPLEMENT PINS

Emission Control System Certification Label

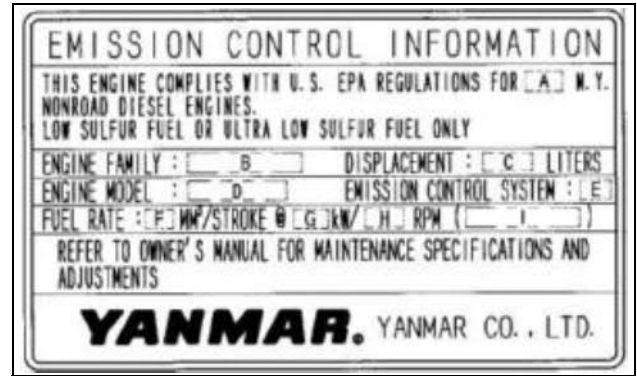

CAUTION: Avoid injury! Statutes providing severe penalties for tampering with emissions controls may apply at the user's location.

The emissions warranty described in the warranty section applies only to those engines marketed by John Deere that have been certified by the United States Environmental Protection Agency (EPA) and/or California Air Resources Board (CARB); and used in the United States in non-road mobile (self-propelled or portable/transportable¹) equipment. The presence of an emissions label like the one shown signifies that the engine has been certified with the EPA and/or CARB. The EPA and CARB warranties only apply to new engines having the certification label affixed to the engine and sold as stated above in the geographic areas governed by the regulating agencies.

NOTE: The hp/kW rating on the engine emissions certification label specifies the gross engine hp/kW, which is flywheel power without fan. In most applications this will not be the same rating as the advertised vehicle hp/kW rating.

1. Equipment moved at least once every 12 months.

SAFETY

Operator Training Required

- Read the operator's manual and other training material. If the operator or mechanic cannot read English, it is the owner's responsibility to explain this material to them. This publication is available in other languages.
- Become familiar with the safe operation of the equipment, operator controls, and safety signs.
- All operators and mechanics should be trained. The owner of the machine is responsible for training the users.
- Never let children or untrained people operate or service the equipment. Local regulations may restrict the age of the operator.
- The owner/user can prevent and is responsible for accidents or injuries occurring to themselves, other people, or property.
- Operate the machine in an open, unobstructed area under the direction of an experienced operator.

Operating Safely

- Only allow responsible adults, who are familiar with the instructions, to operate the machine. Local regulations may restrict the age of the operator.
- A storage location is provided on the machine for the operator's manual. Keep the manual stored securely in this location when not in use and show other operators of this machine where the operator manual is located.
- Inspect machine before you operate. Be sure hardware is tight. Repair or replace damaged, badly worn, or missing parts. Be sure guards and shields are in good condition and fastened in place. Make any necessary adjustments before you operate.
- Be sure all drives are in neutral and parking brake is locked before starting engine. Only start engine from the operator's position.
- Do not change the engine governor settings or overspeed the engine. Operating the engine at excessive speed can increase the hazard of personal injury.
- Check brakes before you operate. Adjust or service brakes as necessary.
- Slow down and use extra care on hillsides. Be sure to travel in the recommended direction on hillsides. For this machine, drive up and down hillsides, not across. Turf conditions can affect the machine's stability. Use caution while operating near drop-offs.
- Stop machine if anyone enters the area. Never carry passengers and keep pets and bystanders away.
- Look behind and down before backing up to be sure of a

clear path.

- Inspect the area where the equipment is to be used and remove all objects such as rocks, toys and wire which can be thrown by the machine.
- If you hit an object or if abnormal vibration occurs, stop the machine and inspect it. Make repairs before you operate. Keep machine and attachments properly maintained and in good working order.
- Do not leave machine unattended when it is running.
- Only operate during daylight or with good artificial light.
- Evaluate the terrain to determine what accessories and attachments are needed to properly and safely perform the job.
- Use only accessories and attachments approved by the manufacturer of the machine. Keep safety labels visible when installing accessories and attachments.
- Do not operate machine if you are under the influence of drugs or alcohol.
- Check before each use that operator presence controls are functioning correctly. Test safety systems. Do not operate unless they are functioning correctly.
- Slow down and be careful of traffic when operating near or crossing roadways. Use care when approaching blind corners, shrubs, trees, or other objects that may obscure vision.
- Do not wear radio or music headphones. Safe service and operation require your full attention.
- Use care when loading or unloading the machine into or off of a trailer or truck.
- Disengage drive to attachments when transporting or not in use.
- Reduce the throttle setting during engine run-out and, if the engine is provided with a fuel shut-off valve, turn the fuel off at the conclusion of mowing.
- When machine is left unattended, stored, or parked, lower the mower deck unless a positive mechanical lock is used.

Using a Spark Arrestor

The engine in this machine is not equipped with a spark arrestor muffler. The California Public Resources Code, section 4442.5 provides as follows:

No person shall sell, offer for sale, lease, or rent to any person any internal combustion engine subject to Section 4442 or 4443, and not subject to Section 13005 of the Health and Safety Code, unless the person provides a written notice to the purchaser or bailee, at the time of sale or at the time of entering into the lease or rental contract,

SAFETY

stating that it is a violation of Section 4442 or 4443 to use or operate the engine on any forest-covered, brush-covered, or grass-covered land unless the engine is equipped with a spark arrestor, as defined in Section 4442, maintained in effective working order or the engine is constructed, equipped, and maintained for the prevention of fire pursuant to Section 4443. Cal. Pub. Res. Code 4442.5.

Other states or jurisdictions may have similar laws. A spark arrestor for your machine may be available from your authorized dealer. An installed spark arrestor must be maintained in good working order by the operator.

Parking Safely

1. Stop machine on a level surface, not on a slope.
2. Disengage PTO and stop attachments.
3. Lower attachments to the ground.
4. Lock park brake.
5. Stop engine.
6. Remove key.
7. Wait for engine and all moving parts to stop before you leave the operator's station.
8. Close fuel shut off valve before servicing the fuel system, if your machine is equipped.
9. Disconnect the battery ground cable before making repairs to electrical system or doing any welding.

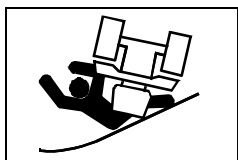

Avoid Tipping

- Slopes are a major factor related to loss-of-control and tip-over accidents, which can result in severe injury or death. Operation on all slopes

requires extra caution.

- Be aware that mechanical front wheel drive (MFWD) can improve access to dangerously sloped terrain, thereby increasing the possibility of a tipover.
- Drive up and down a hill - not across.
- Watch for holes, ruts, bumps, rocks, or other hidden objects. Uneven terrain could overturn the machine. Tall grass can hide obstacles.
- Do not operate machine on wet grass. Tires may lose traction. Tires may lose traction on slopes even though the brakes are functioning properly.
- Choose a low ground speed so you will not have to stop or shift while on a slope.

- Always keep the machine in gear when going down slopes. Do not shift to neutral and coast downhill.
- Avoid starting, stopping or turning on a slope. If the tires lose traction, disengage the blades and proceed slowly, straight down the slope.
- Keep all movement on slopes slow and gradual. Do not make sudden changes in speed or direction, which could cause the machine to roll over.
- Do not operate machine near drop-offs, ditches, embankments, or bodies of water. The machine could suddenly roll over if a wheel goes over the edge or the edge caves in. Leave a safety area between the machine and any hazard.
- Danger of tipping is increased greatly with tires in narrow tread setting and driving at high speed.
- Follow the manufacturer's recommendations for wheel weights or counterweights for added stability when operating on slopes or using front or rear mounted attachments. Remove weights when not required.



Prevent Machine Runaway

- Do not start engine by shorting across starter terminals. Machine will start in gear if normal circuitry is bypassed.
- Never start engine while standing on ground. Start engine only from operator's seat, with transmission in neutral or park.



Use Seat Belt Properly

- Use a seat belt when you operate with a Roll-Over Protective Structure (ROPS) to minimize chance of injury from an accident, such as an overturn.
- Never modify, disassemble or attempt to repair the seat belt.
- Replace entire seat belt if mounting hardware, buckle, belt, or retractor show signs of damage.
- Inspect seat belt and mounting hardware at least once a year. Look for signs of loose hardware or belt damage, such as cuts, fraying, extreme or unusual wear, discoloration, or abrasion. Replace only with John Deere-approved replacement parts.
- Layers of heavy clothing can interfere with proper positioning of the seat belt and can reduce the effectiveness of the seat belt.

SAFETY

Keep ROPS Installed Properly

- Never operate the machine without the ROPS installed.
- Make certain all parts of the ROPS are installed correctly if the ROPS structure is loosened or removed for any reason. All ROPS hardware should be tightened to the proper torque per manufacturer's recommendations.
- Any alteration of the ROPS must be approved by the manufacturer. The protection provided by the ROPS will be impaired if the ROPS is subjected to structural damage, is involved in an overturn incident, or is in any way altered by welding, bending, drilling, or cutting.
- The seat is part of the ROPS safety zone. Replace only with John Deere-approved seat.
- Never attempt to repair a damaged or altered ROPS. It must be replaced to maintain the manufacturer's certification of the structure.



Keep Riders Off

- Only allow the operator on the machine. Keep riders off.
- Riders on the machine or attachment may be struck by foreign objects or thrown off the machine causing serious injury.
- Riders obstruct the operator's view resulting in the machine being operated in an unsafe manner.

Towing Loads Safely

- Stopping distance increases with speed and weight of towed load. Travel slowly and allow extra time and distance to stop.
- Total towed weight must not exceed combined weight of pulling machine, ballast and operator. Use counterweights or wheel weights as described in the attachment or pulling machine operator's manual.
- Excessive towed load can cause loss of traction and loss of control on slopes. Reduce towed weight when operating on slopes.
- Never allow children or others in or on towed equipment.
- Use only approved hitches. Tow only with a machine that has a hitch designed for towing. Do not attach towed equipment except at the approved hitch point.
- Follow the manufacturer's recommendations for weight limits for towed equipment and towing on slopes.
- If you cannot back up a slope with a towed load, the slope is too steep to operate on with the towed load. Reduce the towed load or do not operate.

- Do not turn sharply. Use additional caution when turning or operating under adverse surface conditions. Use care when reversing.
- Do not shift to neutral and coast downhill.

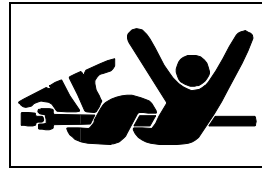

Stay Clear of Rotating Drivelines

Entanglement in rotating driveline can cause serious injury or death.

- Wear close fitting clothing.
- Stop the engine and be sure PTO driveline is stopped before getting near it.

Checking Wheel Hardware

- A serious accident could occur causing serious injury if wheel hardware is not tight.
- Check wheel hardware tightness often during the first 100 hours of operation.
- Wheel hardware must be tightened to specified torque using the proper procedure anytime it is loosened.

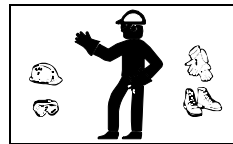

Wear Appropriate Clothing

- Always wear safety goggles, or safety glasses with side shields, and a hard hat when operating the machine.
- Wear close fitting clothing and safety equipment appropriate for the job.
- While operating this machine, always wear substantial footwear and long trousers. Do not operate the equipment when barefoot or wearing open sandals.
- Wear a suitable protective device such as earplugs. Loud noise can cause impairment or loss of hearing.

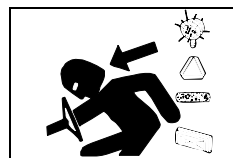

Driving Safely on Public Roads

Avoid personal injury or death resulting from a collision with another vehicle on public roads:

- Use safety lights and devices. Slow moving machines when driven on public roads are hard to see, especially at night.

SAFETY

- Whenever driving on public roads, use flashing warning lights and turn signals according to local regulations. Extra flashing warning lights may need to be installed.



Practice Safe Maintenance

- Only qualified, trained adults should service this machine. Understand service procedure before doing work.
- Never operate machine in a closed area where dangerous carbon monoxide fumes can collect.
- Keep all nuts and bolts tight, especially blade attachment bolts, to be sure the equipment is in safe working condition.
- Never tamper with safety devices. Check their proper operation regularly.
- Keep machine free of grass, leaves or other debris build-up. Clean up oil or fuel spillage and remove any fuel-soaked debris. Allow the machine to cool before storing.
- Never make any adjustments or repairs with the engine running. Wait for all movement to stop on machine before adjusting, cleaning or repairing.
- Check brake operation frequently. Adjust and service as required.
- Maintain or replace safety and instruction labels, as necessary.
- Keep hands, feet, clothing, jewelry, and long hair away from any moving parts, to prevent them from getting caught.
- Lower any attachments to the ground before cleaning or servicing machine. Disengage all power and stop the engine. Lock park brake and remove the key. Let machine cool.
- Securely support any machine elements that must be raised for service work. Use jack stands or lock service latches to support components when needed.
- Disconnect battery or remove spark plug wire (for gasoline engines) before making any repairs. Disconnect negative terminal first and positive last. Install positive terminal first and negative last.
- Before servicing machine or attachment, carefully release pressure from any components with stored energy, such as hydraulic components or springs.
- Release hydraulic pressure by lowering attachment or cutting units to the ground or to a mechanical stop and move hydraulic control levers back and forth.
- Keep all parts in good condition and properly installed. Fix damage immediately. Replace worn or broken parts.
- Charge batteries in an open, well-ventilated area, away

from sparks. Unplug battery charger before connecting or disconnecting from the battery. Wear protective clothing and use insulated tools.



Avoid High Pressure Fluids

- Hydraulic hoses and lines can fail due to physical damage, kinks, age, and exposure. Check hoses and lines regularly. Replace damaged hoses and lines.
- Hydraulic fluid connections can loosen due to physical damage and vibration. Check connections regularly. Tighten loose connections.
- Escaping fluid under pressure can penetrate the skin causing serious injury. Avoid the hazard by relieving pressure before disconnecting hydraulic or other lines. Tighten all connections before applying pressure.
- Search for leaks with a piece of cardboard. Protect hands and body from high pressure fluids.
- If an accident occurs, see a doctor immediately. Any fluid injected into the skin must be surgically removed within a few hours or gangrene may result. Doctors unfamiliar with this type of injury should reference a knowledgeable medical source. Such information is available from Deere & Company Medical Department in Moline, Illinois, U.S.A. Information may be obtained in the United States and Canada only by calling 1-800-822-8262.

Prevent Fires

- Machine fires and structure fires can occur if a machine is stored before allowing it to cool, if debris is not removed from critical areas of the machine, or if machine is stored near combustible materials.
- Remove grass and debris from engine compartment and muffler area, before and after operating machine.
- Always shut off fuel when storing or transporting machine, if the machine has a fuel shutoff.
- Do not store machine near an open flame or source of ignition, such as a water heater or furnace.
- Check fuel lines, tank, cap, and fittings frequently for cracks or leaks. Replace if necessary.

SAFETY

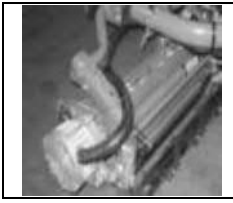

Tire Safety

Explosive separation of a tire and rim parts can cause serious injury or death:

- Do not attempt to mount a tire without the proper equipment and experience to perform the job.
- Always maintain the correct tire pressure. Do not inflate the tires above the recommended pressure. Never weld or heat a wheel and tire assembly. The heat can cause an increase in air pressure resulting in a tire explosion. Welding can structurally weaken or deform the wheel.
- When inflating tires, use a clip-on chuck and extension hose long enough to allow you to stand to one side and NOT in front of or over the tire assembly.
- Check tires for low pressure, cuts, bubbles, damaged rims or missing lug bolts and nuts.

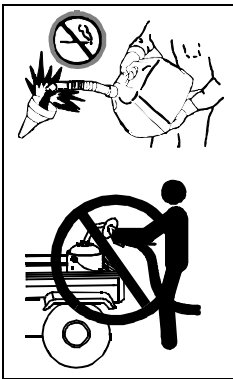

Handling Fuel Safely

To avoid personal injury or property damage, use extreme care in handling fuel. Fuel is extremely flammable and fuel vapors are explosive:

- Extinguish all cigarettes, cigars, pipes, and other sources of ignition.
- Use only an approved fuel container. Use only non-metal, portable fuel containers approved by the Underwriter's Laboratory (U.L.) or the American Society for Testing & Materials (ASTM). If using a funnel, make sure it is plastic and has no screen or filter.
- Never remove the fuel tank cap or add fuel with the engine running. Allow engine to cool before refueling.
- Never add fuel to or drain fuel from the machine indoors. Move machine outdoors and provide adequate ventilation.
- Clean up spilled fuel immediately. If fuel is spilled on clothing, change clothing immediately. If fuel is spilled near machine, do not attempt to start the engine but move the machine away from the area of spillage. Avoid creating any source of ignition until fuel vapors have dissipated.
- Never store the machine or fuel container where there is an open flame, spark, or pilot light such as on a water heater or other appliance.
- Prevent fire and explosion caused by static electric discharge. Static electric discharge can ignite fuel vapors in an ungrounded fuel container.
- Never fill containers inside a vehicle or on a truck or trailer

bed with a plastic liner. Always place containers on the ground away from your vehicle before fueling.

- Remove fuel-powered equipment from the truck or trailer and refuel it on the ground. If this is not possible, then refuel such equipment with a portable container, rather than from a fuel dispenser nozzle.
- Keep the nozzle in contact with the rim of the fuel tank or container opening at all times until the fueling is complete. Do not use a nozzle lock-open device.
- Never overfill fuel tank. Replace fuel tank cap and tighten securely.
- Replace all fuel container caps securely after use.
- For gasoline engines, do not use gas with methanol. Methanol is harmful to your health and to the environment.

Handling Waste Product and Chemicals

Waste products, such as, used oil, fuel, coolant, brake fluid, and batteries, can harm the environment and people:

- Do not use beverage containers for waste fluids - someone may drink from them.
- See your local Recycling Center or authorized dealer to learn how to recycle or get rid of waste products.
- A Material Safety Data Sheet (MSDS) provides specific details on chemical products: physical and health hazards, safety procedures, and emergency response techniques. The seller of the chemical products used with your machine is responsible for providing the MSDS for that product.

OPERATING CONTROLS

Operator Station Controls

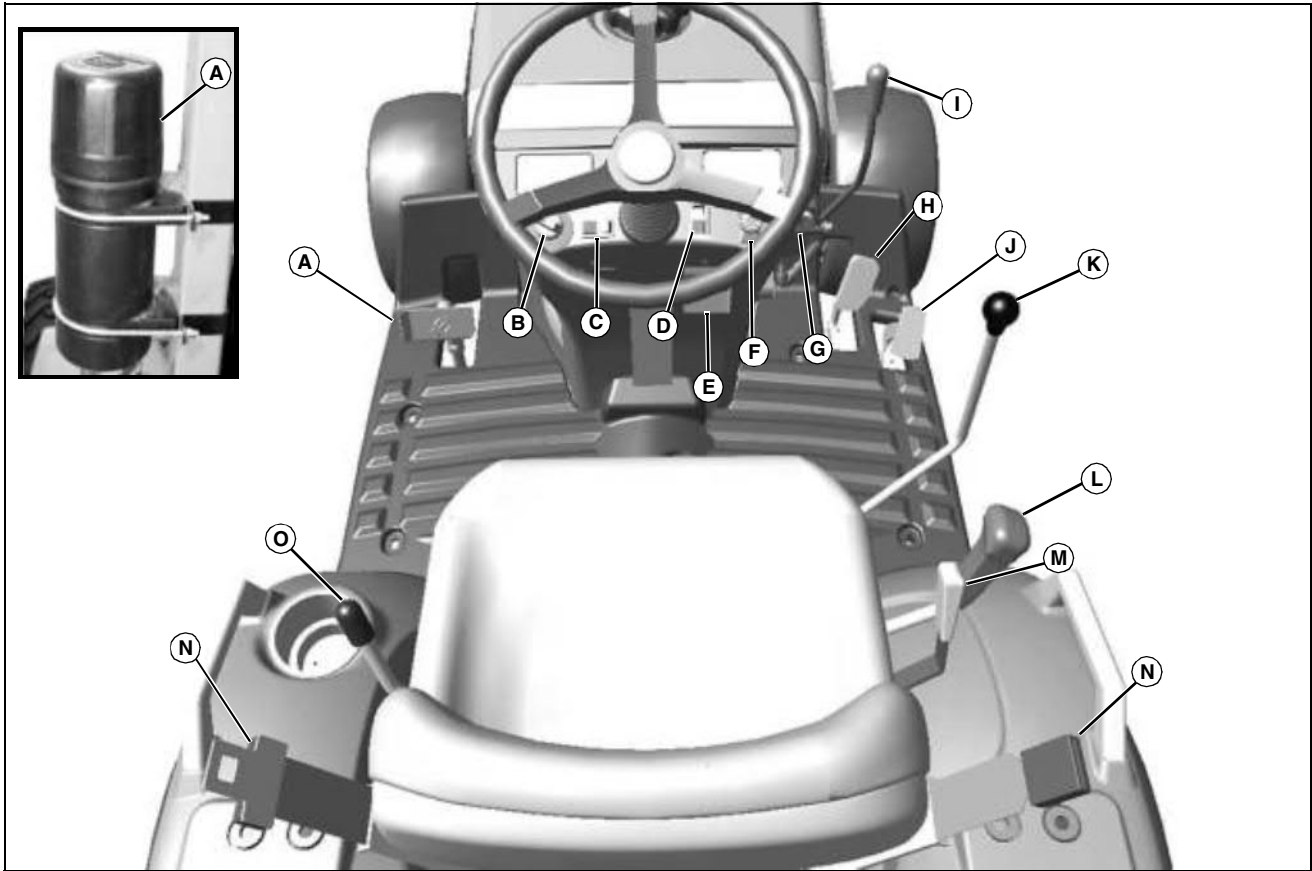

MX27165, MX40337

- A - Brake Pedal
- B - Light Control/Warning Flasher Light Switch
- C - Turn Signal Switch
- D - Cruise Control (Optional)
- E - Park Brake Lock
- F - Power Take Off (PTO) Switch
- G - Ignition Key Switch
- H - Forward Travel Pedal
- I - Engine Speed Hand Throttle
- J - Reverse Travel Pedal
- K - Selective Control Valve (SCV) Lever
- L - Transmission Range Shift Lever
- M - Rockshaft Control Lever
- N - Seat Belt
- O - Power Take Off (PTO) Selector Lever
- P - Operator Manual Holder

Floor Panel Controls

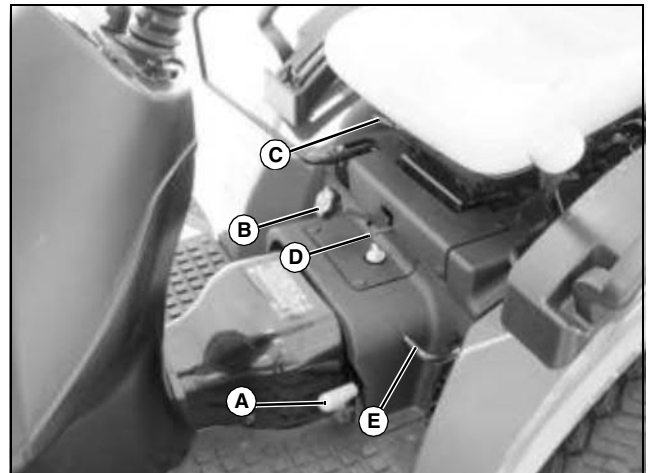

MX35672

- A - Mechanical Front Wheel Drive (MFWD) Control Lever
- B - Rockshaft Rate-of-Drop Control Knob
- C - Operator Seat Adjustment Lever
- D - Selective Control Valve (SCV) Lock Lever
- E - Differential Lock Pedal

OPERATING

Daily Operating Checklist

- Test safety systems. Perform safety interlock system checkout procedure.
- Check tire pressure.
- Check fuel level.
- Check engine oil level.
- Check transmission oil level.
- Check coolant level on liquid cooled engine.
- Remove grass and debris from machine.
- Clean air intake screen.
- Check area below machine for leaks.

Avoid Damage to Plastic and Painted Surfaces

- Do not wipe plastic parts unless rinsed first. Using a dry cloth may cause scratches.
- Insect repellent spray may damage plastic and painted surfaces. Do not spray insect repellent near machine.
- Be careful not to spill fuel on machine. Fuel may damage surface. Wipe up spilled fuel immediately.
- Prolonged exposure to sunlight will damage hood surfaces.

Adjusting Seat

1. Sit on seat.



MX35589

2. Pull seat lever (A) sideways to unlock seat position.
3. Slide seat forward or rearward to desired position where all controls can be easily reached.

4. Release lever to lock seat in position.

Using Seat Belt



CAUTION: Avoid injury! Always wear seat belt when operating machine with non-folding Roll-Over Protective Structure (ROPS) or folding ROPS in upright position. Do not jump from machine if machine tips.

If folding ROPS must be folded to operate in a low clearance area, do not use seat belt. Raise ROPS and use seat belt as soon as conditions permit.

Fasten Seat Belt

1. Connect both ends of seat belt.

Adjusting Seat Belt

1. Tighten or loosen seat belt until firmly held onto the seat.

Release Belt

1. Press red button on buckle to release seat belt ends.

Using Mower Height Control Knob



MX35071

Use mower height control knob (A) to adjust mower cutting height, and lock mower lift kit rear draft arms in raised position. See your mower deck operator's manual for instructions.

IMPORTANT: Avoid damage! To avoid machine damage when operating without a mower, fully raise the mower lift kit rear draft arms, and turn mower height control knob clockwise to highest setting to lock the arms in raised position.

OPERATING

Using Light Switch

NOTE: Normal use of turn signals is possible when light switch is in either warning flasher position. Turn signals will temporarily override warning flashers when activated. When turn signals are de-activated, warning flashers will resume operation.

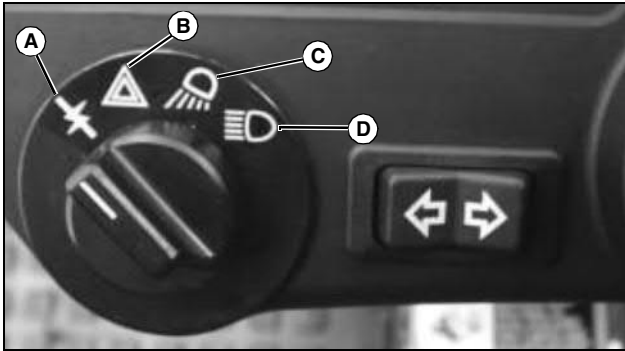

MX12158

- A - All Lights Off
- B - Warning Flasher Lights On
- C - Headlights and Taillights On
- D - Headlights, Taillights, Warning Flasher Lights On

Using Key Switch

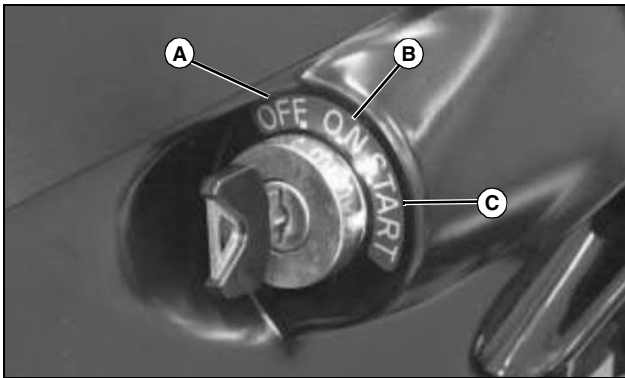

MX8092

- A - OFF Position - In this position the engine will not run.
- B - ON Position - Move key from OFF to this position and the engine oil pressure light and battery charging light will turn on and activate the glow plugs for 3 seconds. You will also hear the engine fuel shut-off solenoid engage with a click.
- C - START Position - Move key from ON to this position and the starter will engage the engine flywheel to start the engine. Release the key to the ON position.

Using Instrument Panel

Right Side Panel

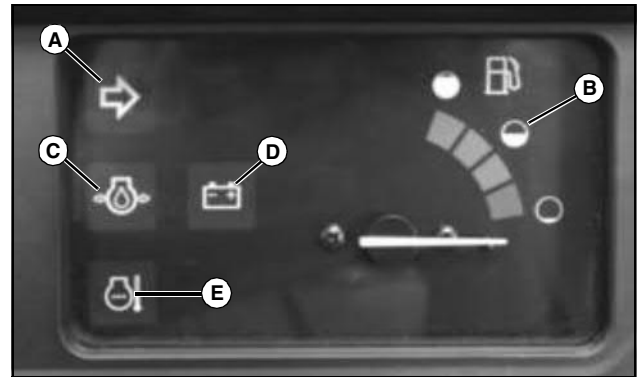

MX17203

A - Warning Flasher/Turn Signal Indicator Light - This indicator light will turn on and flash when the light switch is turned to the warning flasher lights ON position, the headlights, taillights, and warning flasher lights ON position or the turn signal switch is moved to the right hand turn position.

B - Fuel Gauge - Shows approximately how much fuel is in the fuel tank.

C - Engine Oil Pressure Light - This light will turn on when the ignition key is in the ON position and the engine is not running. If this light turns on while the engine is running, engine oil pressure is too low. Stop engine.

D - Alternator/Battery Charging Light - This light will turn on when the ignition key is in the ON position and the engine is not running. If this light turns on while the engine is running, the alternator output is too low. Move the throttle lever to the full throttle position. Stop the engine if light remains on.

E - Engine Coolant Temperature Light - This light will turn on when the engine coolant is approaching a dangerously hot temperature. If this light turns on during operation, remove load on machine immediately. Reduce engine to idle speed and check for something blocking air flow to the radiator and check engine coolant level. If light stays on after cleaning grille, stop engine.

OPERATING

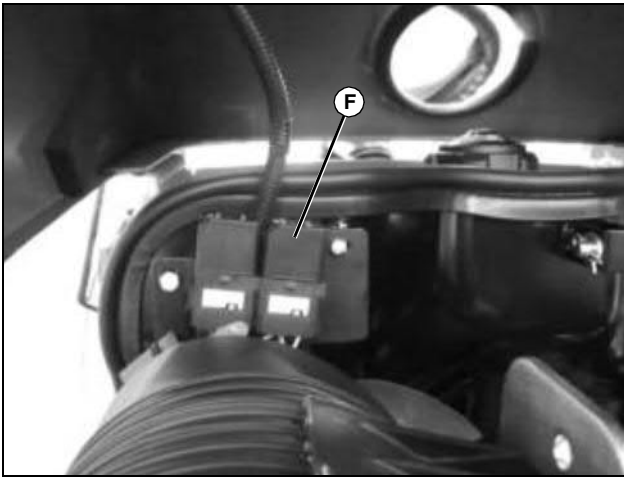

MX45425

• If your tractor is equipped with the engine overheat protection harness, there will be a relay block (F) mounted to the firewall under the hood as shown. For operation of this system, see below:

a. If PTO shuts off during use, check engine coolant temperature light. If light is on, push PTO switch down to shut off switch, lock the park brake, and turn off engine. Allow engine to cool. Check coolant level and add coolant if necessary. Clean debris away from radiator cooling fins. Sit on seat and start engine. Pull PTO up to on position. If PTO still does not engage, see your local John Deere Dealer for service.

Left Side Panel



MX15484

A - Tachometer - Shows engine speed. Engine speed is shown in 100's. Example: If indicator is pointing at 20 (20 x 100 = 2000 RPM). Note the special marker labeled 540. With the indicator pointing at the 540 marker, this is the proper engine speed for the 540 RPM Power Take Off (PTO).

- Slow idle speed 1200 ± 50 rpm
- Rated speed 3000 rpm
- Fast idle speed 3170 ± 50 rpm

B - Warning Flasher/Turn Signal Indicator Light - This

indicator light will turn on and flash when the light switch is turned to the warning flasher lights ON position, the headlights, taillights, and warning flasher lights ON position or the turn signal switch is moved to the left hand turn position.

C - Hour Meter - Shows total number of accumulated running hours at rated speed. Use the hour meter as a guide when servicing various components of this machine.

Using Turn Signal Switch

NOTE: The turn signal switch will operate only when the ignition key switch is in the ON position.

NOTE: Normal use of turn signals is possible when light switch is in either warning flasher position. Turn signals will temporarily override warning flashers when activated. When turn signals are de-activated, warning flashers will resume operation.



MX12158

1. Depress right side of switch (A) to operate the right turn signal light.
2. Depress left side of switch (A) to operate the left turn signal light.
3. Move switch to the centered position to turn lights off.

Testing Safety Systems

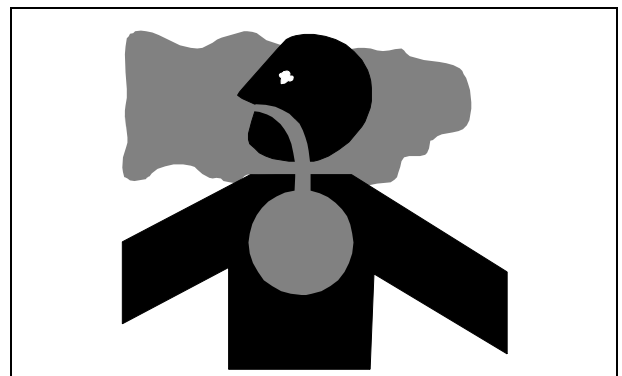



Suggest:

If the above button click is invalid.

Please download this document

first, and then click the above link

to download the complete manual.

Thank you so much for reading

OPERATING



CAUTION: Avoid injury! Engine exhaust fumes contain carbon monoxide and can cause serious illness or death.

- **Move the machine to an outside area before running the engine.**
- **Do not run an engine in an enclosed area without adequate ventilation.**
- **Connect a pipe extension to the engine exhaust pipe to direct the exhaust fumes out of the area.**
- **Allow fresh outside air into the work area to clear the exhaust fumes out.**

The safety systems installed on your machine should be checked before each machine use. Be sure you have read the machine operator manual and are completely familiar with the operation of the machine before performing these safety system checks.

Use the following checkout procedures to check for normal operation of machine.

If there is a malfunction during one of these procedures, do not operate machine. **See your authorized dealer for service.**

Perform these tests in a clear open area. Keep bystanders away.

Testing the Neutral Start Switch

1. Sit on operator's seat.
2. Disengage PTO.
3. Move the transmission range shift lever to the H (high) or L (low) position.
4. Completely depress the forward or reverse hydrostatic drive pedal.
5. Turn key switch to START position.

Result: Engine must not crank.

Testing the Power-Take-Off (PTO) Switch

1. Sit on operator's seat.
2. Move the transmission range shift lever to the N (neutral) position.
3. Engage PTO.
4. Turn key to the START position.

Result: Engine must not crank.

Testing the Seat Switch

1. Sit on operator's seat.
2. Return hydrostatic travel pedals to neutral position.
3. Lock park brake.
4. Start engine.
5. Move the transmission range shift lever to the H (high) or L (low) position.
6. Raise up slightly from operator's seat. Do not dismount machine.

Result: Engine shut-off solenoid must de-energize in 1/2 second, causing the engine to stop.

Using Brake Pedal

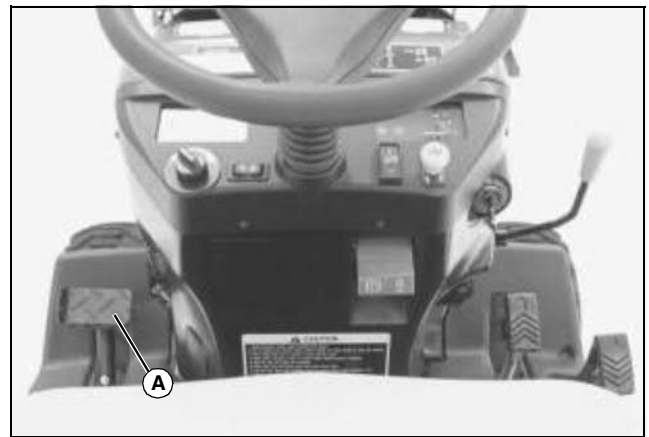

MX35590

1. Depress pedal (A) to operate the brake.

Using Park Brake

NOTE: Label on dash illustrates park brake operation.

<https://www.ebooklibonline.com>

Hello dear friend!

Thank you very much for reading.

Enter the link into your browser.

The full manual is available for immediate download.

<https://www.ebooklibonline.com>