

**JOHN DEERE
2030
TRACTOR
(SERIAL NO. 187301-)**



**OPERATORS MANUAL
JOHN DEERE 2030 TRACTOR
(SERIAL NO. 187301-)**

OMR59805 F4 English

**JOHN DEERE WATERLOO WORKS
OMR59805 F4**

LITHO IN THE U.S.A. (REVISED)
ENGLISH





To the Purchaser

This new tractor was carefully designed and manufactured to give years of dependable service. To keep it running efficiently, read the instructions in this operator's manual. Each section is clearly identified so you can easily find the information you need—whether it is operation, lubrication and periodic service, or trouble shooting. Check the Contents to learn where each section is located. Use the alphabetical index for fast reference.



Worldwide graphic symbols are used to assist identification and operation. In this manual, an identifying symbol is placed by the instructions like the symbol at left for the engine coolant temperature gauge. The waves signify water or coolant and the thermometer indicates temperature. Regardless of the language used in a nation, this symbol means water or coolant temperature without translation.

Record your tractor serial numbers in the spaces provided on page 73. Your dealer needs this information to give you prompt, efficient service and parts. If your tractor requires replacement parts, go to your John Deere dealer where you can obtain genuine John Deere parts—accept no substitutes.

This warranty on this tractor appears on your copy of the purchase order which you should have received from your dealer when you purchased the tractor.

The references in this manual to the "right-hand" and the "left-hand" sides of the tractor are determined by facing in the direction of tractor forward travel.



This safety alert symbol indicates important safety messages in this manual. When you see this symbol, be alert to the possibility of personal injury and carefully read the message that follows.

Your operator's manual contains SI Metric equivalents which follow immediately after the U.S. customary units of measure.

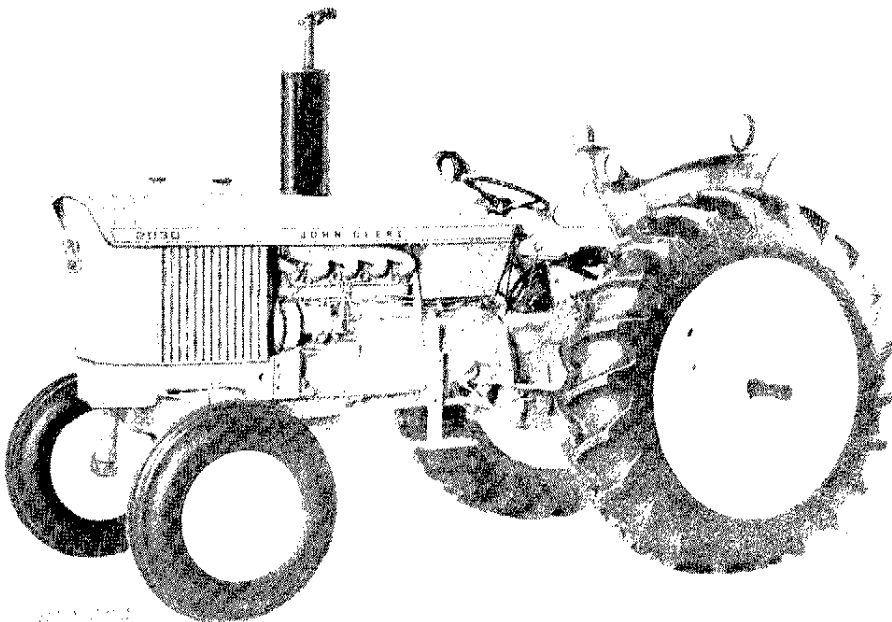



Contents

	Page
SAFETY RULES	2
CONTROLS AND INSTRUMENTS	4
OPERATION	5
FUELS AND LUBRICANTS	40
LUBRICATION AND PERIODIC SERVICE	42
SERVICE	58
TRACTOR STORAGE	66
TROUBLE SHOOTING	68
SPECIFICATIONS	72
INDEX	74

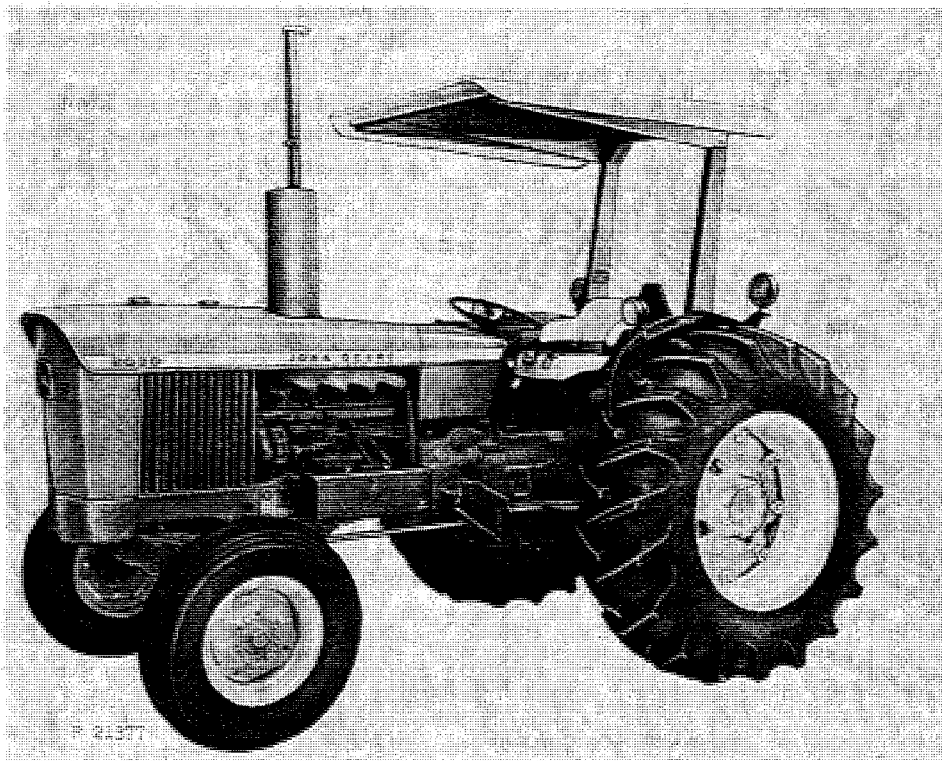

John Deere 2030 Tractor Equipped With Roll-Gard and Canopy

<https://www.ebooklibonline.com>

Hello dear friend!

Thank you very much for reading.

Enter the link into your browser.

The full manual is available for immediate download.

<https://www.ebooklibonline.com>



Safety Rules

⚠ Power take-off guards, shields, and other safety features are built into the tractor whenever possible. However, investigation of thousands of accidents shows that careless use of machinery causes a high percentage of accidents. You can avoid many accidents by observing the rules for safety given here. Study these rules carefully and insist that they be followed by those working with you and for you.

All power equipment should be operated only by those who are responsible and delegated to do so.

Provide a first-aid kit for use in case of accident.

Reduce speed before turning quickly or applying brakes. Couple the brake pedals together when traveling at high speeds. Brake both wheels simultaneously when making an emergency stop. Always drive slowly over rough ground. Drive at speeds slow enough to insure your safety.

Never tow the tractor at high speed.

Towed loads that weigh more than twice the weight of the tractor should have brakes. If not, reduce speed and avoid inclines.

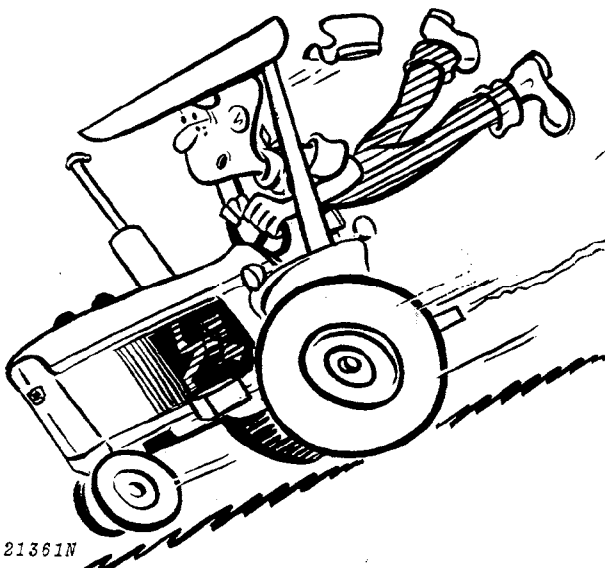

R21361N

Always keep the tractor in gear when going down steep hills or grades.

When pulling heavy towed loads at road speeds, use extreme caution and avoid hard applications of the tractor brakes at high speeds. When descending steep grades, select a sufficiently low gear to maintain control with minimum braking.

Keep a firm grip on the steering wheel at all times when speed is increased.

The rate of tractor travel on hillsides and curves should always be such that there is no danger from tipping.

Be careful to prevent the tractor from tipping sideways if it strikes a hole, ditch, or other irregularity, especially when operating on hillsides.

When driving out of a ditch, gully, or up a steep hillside, engage the clutch slowly. Be prepared to disengage the clutch promptly should the front wheels rise off the ground. Observe the same precautions if the rear wheels become mired in soft ground or drop in a hole. Back the tractor out of these situations.

When hitching a heavy towed load to the tractor, always hitch to the drawbar. When using a chain, be sure to take up the slack in the chain slowly.

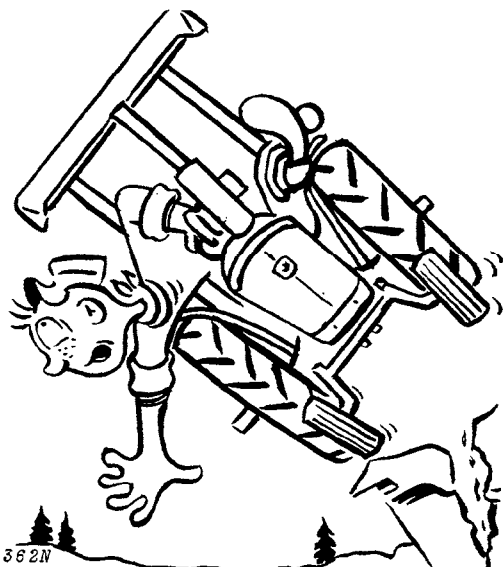

R21362N

Do not drive near the edge of a ditch or gully.

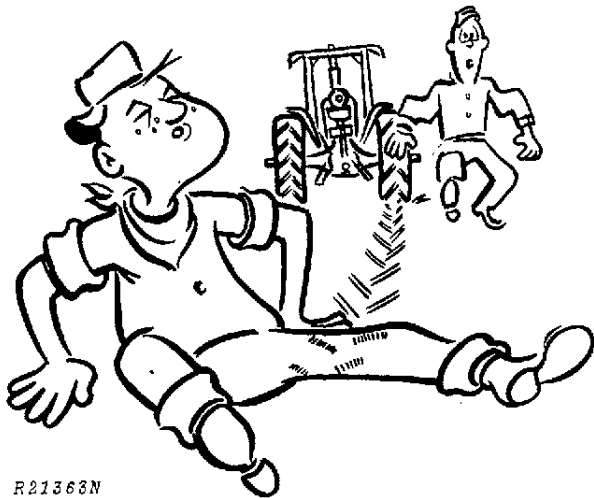

R21363N

Only one person—the operator—should be permitted on the tractor when it is in operation. Never allow a person to ride on drawbar or hitch.

When hitching drawn equipment to the drawbar, back the tractor past the clevis. Then move forward so that, in making the connection, the tractor will be moving away from the equipment.

Before dismounting, stop the tractor, place the transmission in park, lower implements to the ground, and shut off the engine.

Never attempt to start or to operate the tractor except from the operator's station.

Never operate the tractor engine in a closed building.

A protective Roll-Gard with seat belt is available for your tractor. A canopy that fits on top of the Roll-Gard is also available.

Under almost all operating conditions:

1. The use of a seat belt with the optional John Deere Roll-Gard is recommended.
2. Its use without roll-over protective equipment is not recommended.

When transporting or driving the tractor on a road or highway at night or during the day, use accessory lights and devices for adequate warning to the operators of other vehicles. In this regard check local governmental regulations. Various safety lights and devices are available from your John Deere dealer.

In local areas where flashing lights are prohibited by local regulations, be sure the flasher for warning lamps is disconnected.

When meeting a vehicle on the highway at night, dim the tractor headlights. Be sure the lights are adjusted so they will not blind the operator of an oncoming vehicle.

Since loose clothing might catch in moving parts, always keep sleeves, jackets, or other clothing relatively tight and belted.

Always make sure the engine is stopped, the PTO is disengaged, and the PTO shaft is stopped, before attempting to connect or adjust the implement hitch or power take-off hook-up or before attempting to clean out a PTO-driven implement.

Remove the PTO master shield only when necessary. Always install the PTO guard on the power take-off when the PTO is not being used. When the PTO is being used, be sure all PTO shields are in place on the tractor and the implement.

Do not oil, grease, adjust, or repair the tractor or implement while it is in motion or while the engine is running unless specifically recommended.

Poor maintenance or improper adjustment of the tractor or implement may result in a hazardous situation. Follow the recommended procedures and do not ignore items requiring maintenance or tightening.

Before making adjustments on engine or electrical system, disconnect battery ground cable from each battery. This prevents sparks which create a dangerous fire and explosion hazard and may cause damage or personal injury.

Before using booster batteries, read instructions under additional battery on page 10. To avoid sparks if a battery needs recharging, turn battery charger off before making connections or disconnections.

Add coolant to the radiator only when the engine is stopped or slowly idling. To avoid being scalded when the pressure-type filler cap is being removed, turn the cap slightly to the stop to relieve pressure before removing the cap.

Use precaution in handling ether starting fluid or any type of tractor fuel. Never refuel the tractor when the engine is hot or running. Do not smoke while using starting fluid, filling the fuel tank, or servicing the fuel system.

It is a good practice to have a fire extinguisher nearby. Be sure that the extinguisher is properly maintained and be familiar with its proper use.

Escaping hydraulic oil or diesel fuel under pressure can have sufficient force to penetrate the skin, causing serious personal injury. Before disconnecting lines, be sure to relieve all pressure. Before applying pressure to the system, be sure all connections are tight and that lines, pipes and hoses are not damaged. Fluid escaping from a very small hole can be almost invisible. Use a piece of cardboard or wood, rather than hands, to search for suspected leaks.

If injured by escaping fluid, see a doctor at once. Serious infection or reaction can develop if proper medical treatment is not administered immediately.



Controls and Instruments

Before attempting to operate your new tractor, become familiar with the location and purpose of its controls and instruments. Additional information will be found on the page number following the control or instrument. Worldwide graphic symbols are used to assist identification and operation.

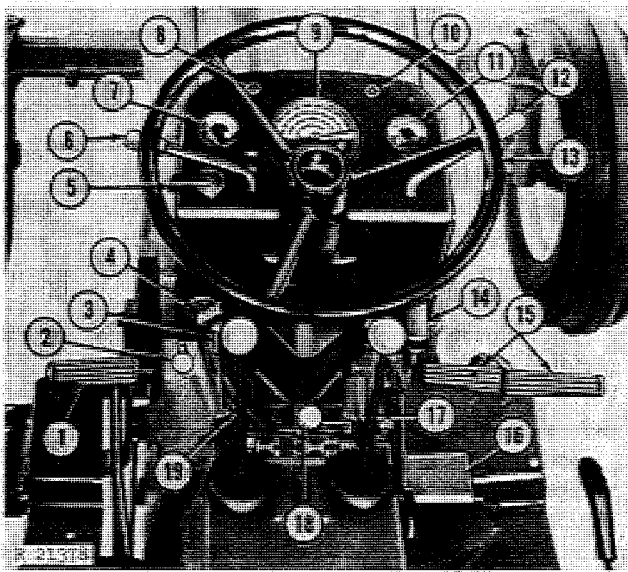

- 1—Clutch Pedal (Page 12)
- 2—Engine Stop Knob (Pages 5 and 9)
- 3—Key Switch (Page 5)
- 4—Light Switch (Page 24)
- 5—Turn Signal Lever (Page 23)
- 6—Hi-Lo or Reverser Lever (Pages 12 and 13)
- 7—Coolant Temperature Gauge (Page 9)
- 8—Alternator Indicator Light (Page 5)
- 9—Speed-Hour Meter (Page 42)
- 10—Oil Pressure Indicator Light (Page 5)
- 11—Fuel Gauge
- 12—Hand Throttle (Page 8)
- 13—Steering Wheel
- 14—Ether Starting Fluid Adapter (Page 6)
- 15—Brake Pedals (Page 14)
- 16—Foot Throttle (Page 8)
- 17—Gear Shift Lever (Page 12)
- 18—Independent PTO Lever (Page 37)
- 19—Range Shift Lever (Page 12)

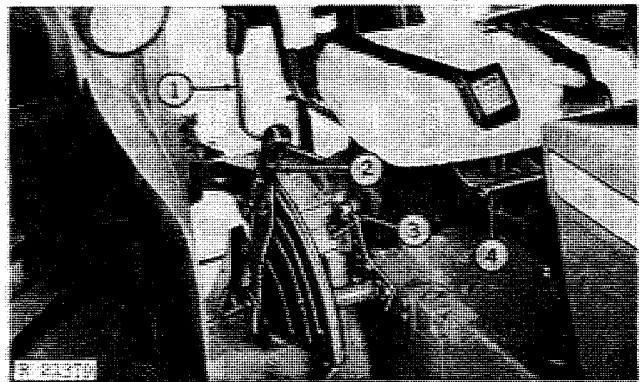

- 1—Remote Cylinder Operating Levers (Page 31)
- 2—Rockshaft Control Lever (Page 25)
- 3—Rockshaft Selector Lever (Page 25)
- 4—Seat Latch (Page 10)

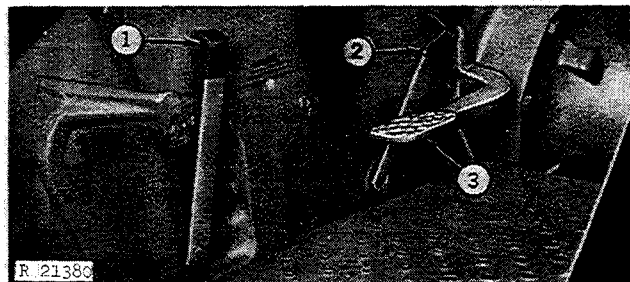

- 1—Mid PTO Lever (Page 37)
- 2—Rear PTO Lever (Page 37)
- 3—Differential Lock Pedal (Page 14)



Operation

Complete instructions for operating your tractor safely and efficiently are given on the following pages. By following these directions carefully, you can be sure that you are taking full advantage of the many features built into your tractor.

PRESTARTING CHECKS

Perform the following checks and services before starting the engine or operating tractor for the first time each day:

Check the engine crankcase oil level—see page 48.

Check the radiator coolant level—see page 48.

Drain sediment from fuel filter—see page 48.

Make sure the fuel shut-off valve on the fuel tank is open. See page 54.

Lubricate front axle. See page 48.

CAUTION: Before starting the tractor engine, be sure there is plenty of ventilation. Never operate the tractor in a closed building.

OPERATING THE ENGINE

STARTING THE ENGINE

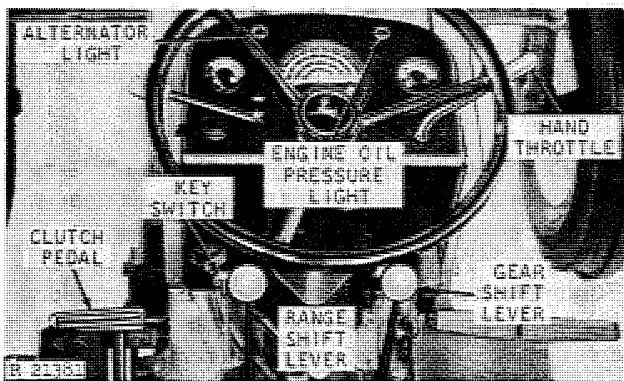

Engine Starting Controls

NOTE: If the prevailing temperature is 32°F. (0°C.) or lower, it may be necessary to use a cold weather starting aid to start the engine (page 6).

Perform the Prestarting Checks listed above.



(1) See that the transmission is in PARK (see worldwide symbol at left), the PTO is disengaged, the rockshaft control lever is in lowered position, the remote cylinder operating levers in neutral, and the engine stop knob is pushed all the way in.

Before the starter will operate, the range shift lever must be in PARK or neutral.

(2) Place the hand throttle in the 1200 rpm position, approximately one-third of its travel downward. Depress the clutch pedal.

(3) Turn the key switch clockwise to the first position.



The alternator indicator light and the oil pressure indicator light should glow. If any light fails to glow, turn off the key switch and determine the cause.

6 Operation - Engine

(4) Turn the key switch all the way to the right to start the engine. Do not operate the starter for more than 30 seconds at a time. To do so may overheat the starter. If the engine does not start the first time, wait for a minute or two before trying again. If it does not start after four attempts, see "Trouble Shooting."

If the key switch is released before the engine starts, wait until the starter and the engine stop before trying again. This will prevent possible damage to the starter.

IMPORTANT: Never attempt to start a tractor with Hi-Lo Shift or reverser by towing or pushing, or you may damage the clutches.

Before starting a tractor by towing, see page 13.

(5) As soon as engine starts, release key switch. The engine oil pressure indicator light and the alternator indicator light should go out. If the lights do not go out after the engine has been running for 10 seconds, the engine should be shut off at once and the cause of difficulty determined.

(6) Release clutch pedal. In cold weather, warm engine and transmission for 5 minutes by operating engine at half throttle. Do not allow engine to operate at slow idle speed during engine warm-up. Observe gauges.

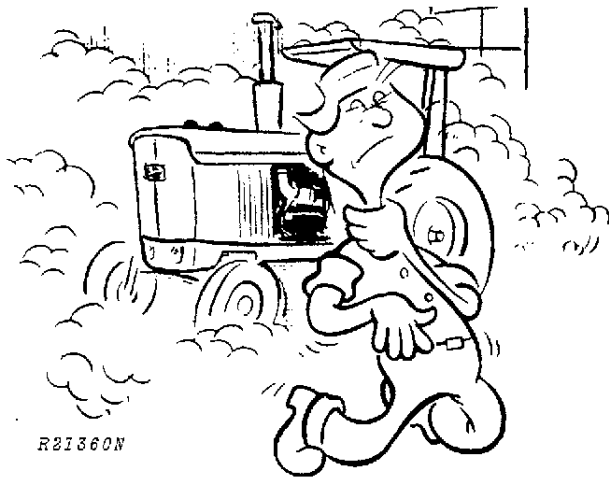

CAUTION: Before starting the engine, make sure there is plenty of ventilation. Never operate the engine in a closed building.

COLD WEATHER STARTING AIDS

For cold weather starting, the tractor may be equipped with an ether starting fluid adapter, additional battery, engine coolant heater, or a hydraulic pump shut-off screw.

These aids are effective at low temperatures only when the engine is otherwise operating satisfactorily. They will not correct such deficiencies as low battery charge, crankcase oil of high viscosity, and high electrical resistance which may prevent the engine from starting.

Ether Starting Fluid Adapter



Injecting Starting Fluid

This adapter is used to inject atomized starting fluid into the engine air intake system. Pressurized cans of starting fluid are available from your John Deere dealer.

CAUTION: Ether starting fluid is highly flammable. Do not use near fire, sparks, or flames. Read the cautionary information on the container.

To use the can of starting fluid, remove the safety cap and plastic spray button from the can. Remove the cap from the adapter and position the can under the adapter.

To inject a shot of starting fluid, momentarily push up on the can.

IMPORTANT: To avoid damage, turn engine with starter one or two revolutions before injecting starting fluid. Inject starting fluid only while the engine is turning.

Relax pressure on the can between shots of starting fluid. Stop injecting fluid after the engine starts. If the engine begins to die during the first few minutes of operation, inject another shot of fluid. When the engine is operating satisfactorily, remove the can from the adapter and replace the safety cap on the can to avoid accidental discharge.

Be sure to install the cap on the adapter when it is not in use. This will prevent dust from being drawn into the engine.

Store starting fluid in a cool, dry, and protected area to prevent accidental discharge. Keep the starting fluid away from extreme heat or cold.

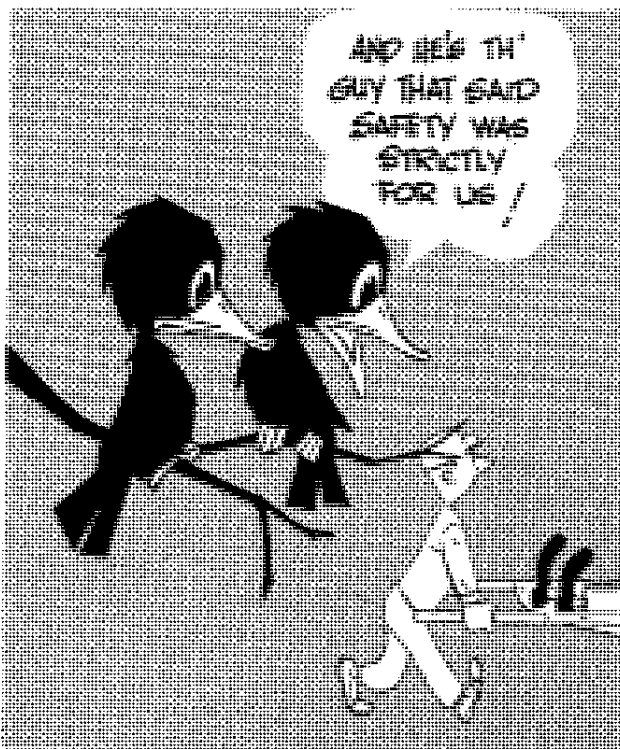

Hydraulic Pump Shut-Off

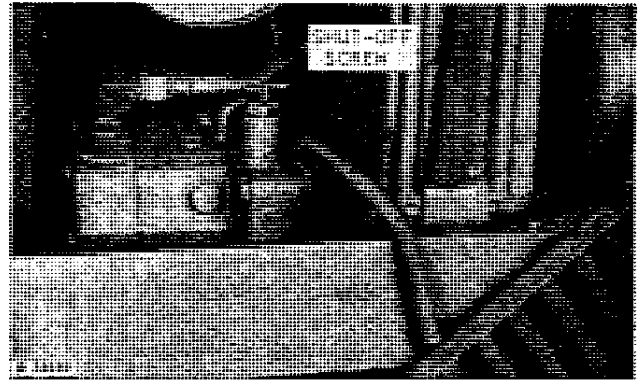

Hydraulic Pump Shut-Off Screw

If the tractor has a hydraulic pump shut-off screw (available from your John Deere dealer), the cranking speed may be increased during cold weather by destroying the hydraulic pump so it will not build up pressure. To destroy the pump, turn the shut-off screw in (clockwise) until resistance is felt. Turn screw in one more turn.

After the engine has started, back the shut-off screw out all the way (turn the screw counterclockwise). The pump will now build up pressure.

NOTE: Oil will leak past the shut-off screw if it is not backed out all the way against the internal stop.

Electric Coolant Heater

A 1000-watt, 115-volt electrical coolant heater can be installed on the engine. See your dealer for additional information.

CAUTION: To avoid shock or hazardous operation, always use a three-wire heavy-duty electrical cord equipped with three-wire connectors. If a two-to-three contact adapter is used at the wall receptacle, always connect the green wire to a good ground.

Additional Battery

Starting the engine in cold weather can be made easier by connecting an additional 12-volt battery in parallel with the 12-volt battery or batteries on the tractor.

CAUTION: Gas given off by batteries is explosive. To avoid injury or battery damage, avoid sparks near the batteries.

Connect a jumper cable to the POSITIVE (+) post of a 12-volt booster battery and to the POSITIVE (+) post of the tractor battery. Connect one end of the other jumper cable to the negative post of the booster battery and to a good ground on the tractor frame away from the battery. Never connect jumper cables to pipes or thin sheet metal.

IMPORTANT: Reversed polarity booster battery connections may damage the alternator or electrical wiring.

See your John Deere dealer for booster batteries.

TRACTOR WARM-UP PERIOD

Always be sure the tractor is warmed up properly before operating under a full load.

A good way to do this is first to idle the engine at about 1500 rpm for 5 minutes and then operate it at about 1900 rpm for another 5 minutes.

It is good practice to operate the tractor for the first 30 minutes in a lower gear than is normally required for the load. This gives the oil a chance to circulate freely and prevents undue wear on engine or transmission parts.

ENGINE IDLING

Avoid unnecessary engine idling. Prolonged engine idling may cause the engine coolant temperature to fall below its normal range. This in turn causes crankcase oil dilution, due to incomplete fuel combustion, and permits formation of gummy deposits on valves, pistons, and piston rings. It also promotes rapid accumulation of engine sludge and unburned fuel in the exhaust system.

When the tractor is to remain idle for a considerable length of time, stop the engine.

ENGINE SPEEDS

The tractor engine is designed to operate at working speeds ranging from 1500 to 2500 rpm. The engine can be operated at any speed in the working range to meet various operating conditions. Operate the engine at 2100 rpm to obtain the ASAE Standard PTO speeds.

Normal slow idle speed is approximately 800 rpm.

The engine speed of 2500 rpm is the speed when under full load. At light or no load condition the speed may rise to approximately 2660 rpm. See page 50 for no load engine speeds.

Hand Throttle

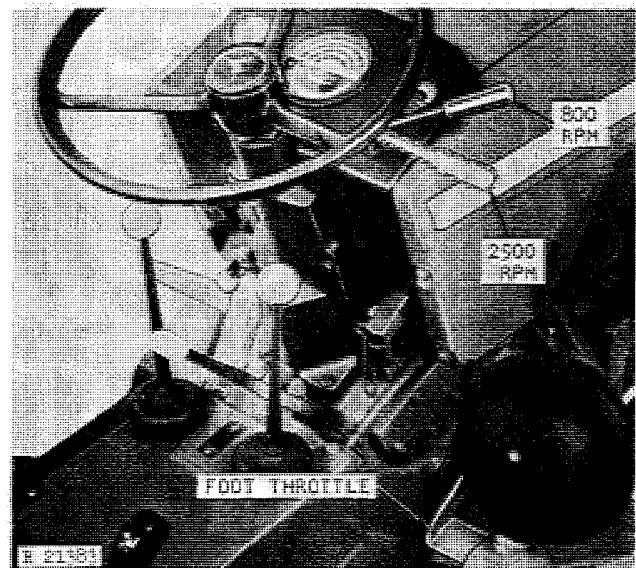

Hand Throttle and Foot Throttle

Use the hand throttle to select any desired engine speed between slow idle and fast idle. Push hand throttle lever upward to reduce engine speed; pull lever downward to increase engine speed.

Foot Throttle

The foot throttle is used to obtain engine transport speeds or to raise engine speed momentarily. When the foot throttle is pushed all the way downward, the engine operates at 2800 rpm fast idle speed.

NOTE: The foot throttle should not be used to increase the normal engine working speed.

STOPPING THE ENGINE

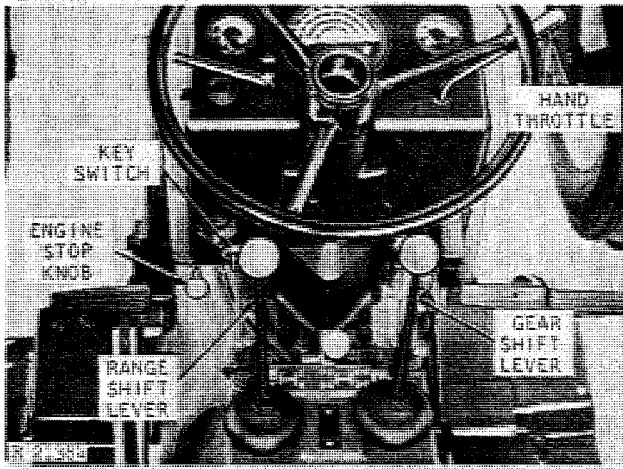

Engine Stopping Controls

Stop the engine as follows:

Move the gear shift lever into any gear position. Then place the range shift lever in park (P) position. This will lock the gears and hold the tractor in place.

Run the engine at 1500 rpm for a short time before stopping it. Sudden stopping of a hot engine may allow some parts to overheat momentarily and possibly cause damage.

After idling the engine for a few minutes, move the hand throttle to the slow idle position and pull the engine stop knob all the way out. After the engine stops, release the stop knob. The knob should move all the way in. Turn the key switch off.

After stopping the engine, remove the key from the switch to prevent tampering and unauthorized operation. Removing the key also prevents the switch from being accidentally left in the "on" or the "accessory" position and causing battery discharge.

Before dismantling, be sure all equipment is lowered to the ground, the light switch and other accessory switches are off, and the transmission is in PARK.

BREAKING IN THE ENGINE



If the coolant temperature rises to the warning zone on the gauge, shift to a lower gear to reduce the load on the engine. Be sure to follow the special break-in lubrication instructions given on page 42.

With the following exceptions, the engine is ready for normal operation:

During the first 20 hours, do not use the foot throttle or place the hand throttle in speeds above the 2100 rpm load speed position. To facilitate break-in, avoid prolonged periods of engine idling for the first 100 hours of service.



R 2213

OPERATING THE TRACTOR

SEAT

Your tractor may be equipped with a regular seat or a deluxe cushioned seat. The seats are adjustable for the operator's height, and fold back for standing. The deluxe seat also is adjustable for the operator's weight.

Moving Seat to Upper Rear Position

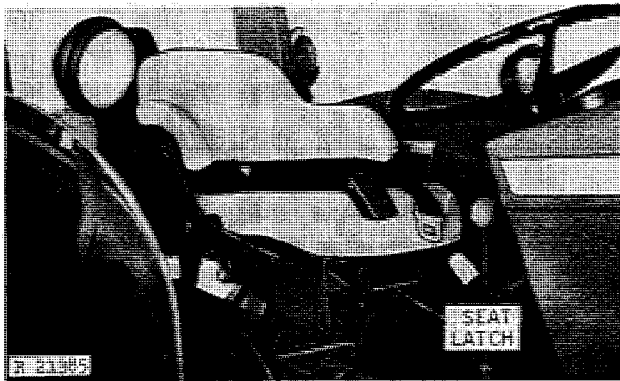

Deluxe Seat

Deluxe Seat. Lift the release latch (shown). Stand up and lift the seat to the upper rear. To return the seat to the normal position, pull the seat forward. Sit down on the seat to lock it in place.

Regular Seat. Lift back of seat and push seat to rear. To return the seat to the normal position, lift the front of the seat and move it forward.

Adjusting for Height and Weight of Operator

To adjust the seat for operator's height, loosen the cap screws securing the seat to the rockshaft housing or seat support base and slide seat to desired position. Then securely tighten cap screws.

The deluxe seat is adjustable for operators weighing from 100 to 300 pounds (45.4 to 136.1 kg). To adjust, move the seat to the upper rear position to take tension off the spring. Loosen the wing nuts under the weight adjustment link, and move slide to desired weight position. Tighten wing nuts and return seat to the normal position.

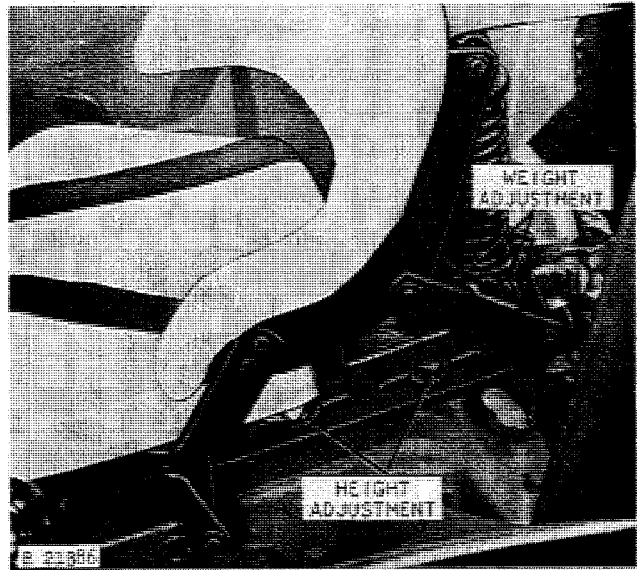

*Adjusting Seat for Operator's Weight and Height
(Deluxe Seat Shown)*

Adjust deluxe seat shown in illustrations below as follows:

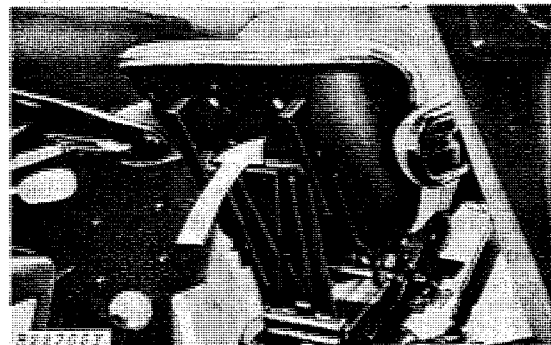

Moving Seat to Upper Rear Position

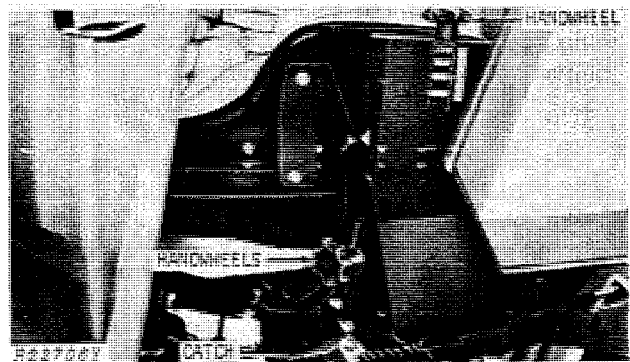

Adjusting Seat for Operator's Weight and Height

Raise catch and adjust horizontally.

Loosen handwheels on both sides and adjust seat to desired height.

Use top handwheel for adjusting for operator's weight. The seat is adjusted correctly if the arrow on the backrest is in line with the arrow on the seat adjustment frame when the operator is seated.

ROLL-GARD, SEAT BELT, AND CANOPY

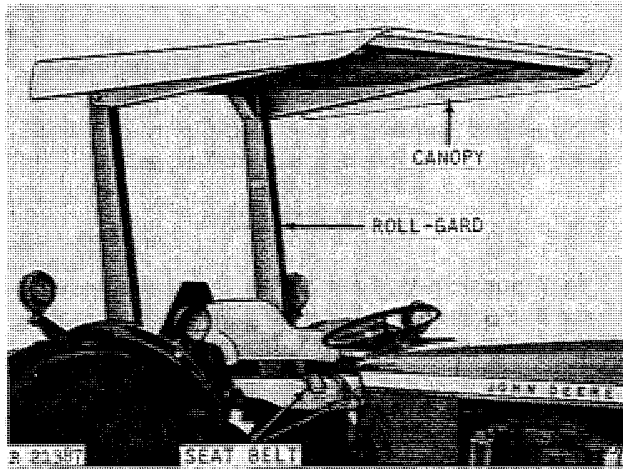

Roll-Gard, Seat Belt, and Canopy

A protective Roll-Gard with seat belt is available for your tractor. A canopy that fits on top of the Roll-Gard is also available.

See page 65 for additional information.

⚠ CAUTION: Under almost all operating conditions:

1. Use of the seat belt with the optional John Deere Roll-Gard is recommended.
2. Use of a seat belt without roll-over protective equipment is not recommended.

SELECTING GROUND SPEED

The tractor has eight forward speeds and four reverse speeds (sixteen forward and eight reverse speeds if tractor has the Hi-Lo shift option). The wide range of speeds, together with the variable speed engine, allow the operator to balance load and speed for maximum economy, and give him flexibility to meet varying work conditions. For example, for a given travel speed the operator may choose to work in a low gear at a high engine speed or in a higher gear at a lower engine speed. Engine working speeds may be varied anywhere between 1500 and 2500 rpm.

Avoid overloading the tractor. When this occurs, operate in a lower gear. If moving the throttle slightly will change engine speed, the engine is not overloaded or lugging. Overloading causes undue strain on parts, eventually resulting in poor operation and unnecessary repair and expense.

TRACTOR GROUND SPEED IN MILES PER HOUR (KILOMETRE PER HOUR)

NOTE: The travel speeds shown are for tractors with 14.9-28 rear tires. Travel speeds for tractors with 13.6-28 rear tires are 4% slower; 13.6-38 tires, 7% faster; 15.5-38 tires, 6% faster*; 16.9-24 tires, 6% slower; 16.9-28 tires, 3% faster; 16.9-30 tires, 2% slower*; and 18.4-26 tires, 5% faster.*

Gear	Lo of Hi-Lo Shift Option			Collar Shift Transmission Hi of Hi-Lo Shift Option Reverser Option		
	1500 rpm	2100 rpm	2500 rpm	1500 rpm	2100 rpm	2500 rpm
1st	0.7 (1.1)	1.0 (1.6)	1.2 (1.9)	0.9 (1.4)	1.3 (2.1)	1.5 (2.4)
2nd	1.0 (1.6)	1.4 (2.3)	1.7 (2.7)	1.3 (2.1)	1.8 (2.9)	2.1 (3.4)
3rd	1.5 (2.4)	2.1 (3.4)	2.5 (4.0)	1.9 (3.1)	2.6 (4.2)	3.2 (5.1)
4th	2.1 (3.4)	2.9 (4.7)	3.5 (5.6)	2.6 (4.2)	3.7 (6.0)	4.4 (7.1)
5th	2.7 (4.3)	3.8 (6.1)	4.5 (7.2)	3.5 (5.6)	4.9 (7.9)	5.8 (9.3)
6th	3.9 (6.3)	5.5 (8.9)	6.5 (10.5)	5.0 (8.0)	7.0 (11.3)	8.3 (13.4)
7th	5.8 (9.3)	8.2 (13.2)	9.7 (15.6)	7.4 (11.9)	10.4 (16.7)	12.3 (19.8)
8th	8.2 (13.2)	11.4 (18.3)	13.6 (21.9)	10.4 (16.7)	14.5 (23.3)	17.3 (27.8)
R1	0.8 (1.3)	1.1 (1.8)	1.4 (2.3)	1.0 (1.6)	1.5 (2.4)	1.7 (2.7)
R2	1.2 (1.9)	1.6 (2.6)	1.9 (3.1)	1.5 (2.4)	2.1 (3.4)	2.5 (4.0)
R3	1.7 (2.7)	2.4 (3.9)	2.9 (4.7)	2.2 (3.5)	3.1 (5.0)	3.7 (6.0)
R4	2.4 (3.9)	3.4 (5.5)	4.0 (6.4)	3.1 (5.0)	4.3 (6.9)	5.1 (8.2)

Maximum travel speed at 2800 engine rpm (obtained with foot throttle) is 19.3 mph. 2100 engine rpm gives the ASAE 540 or 1000 rpm PTO speed.

*Differential drive ratio changed when equipped with 13.6-38, 15.5-38 or 16.9-30 tires.

SHIFTING GEARS

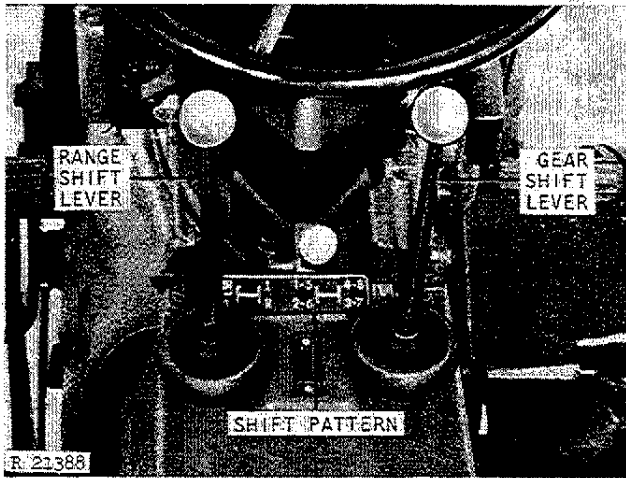

Range and Gear Shift Levers

Gear shifting is controlled by a range shift lever and a gear shift lever.

The range shift lever shifts between low, high, and reverse ranges. A park (P) position is also provided.

The gear shift lever can be used to select 1st, 2nd, 3rd, and 4th gears when the range shift lever is in low range position; it can be used to select 5th, 6th, 7th, and 8th gears when the range shift lever is in high range position. When the range shift lever is in reverse range, reverse gears comparable to 1st, 2nd, 3rd, and 4th can be obtained. On tractors with a reverser, the range shift lever does not have an R position.

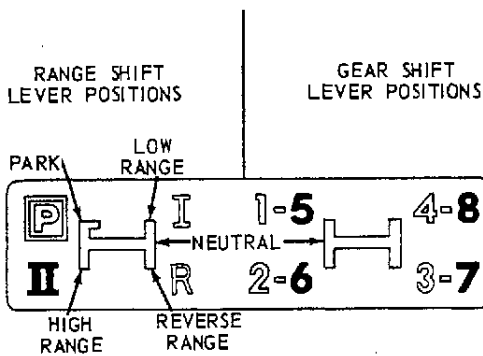

Transmission Shifting Pattern

The shift patterns are marked by a decal on the transmission case shield.

With the tractor stopped and the clutch pedal depressed, move the gear shift lever into the gear desired. Then move the range shift lever into the range desired. Shift levers must be placed fully into position.

When shifting from one gear to another or one range to another, fully stop the tractor before depressing the clutch and moving the shift lever.

Gradually release the clutch pedal to take up the load smoothly.

To prevent unnecessary wear, never "ride" (resting the feet on) the clutch or brake pedals.

HI-LO SHIFT

The optional Hi-Lo Shift allows the operator to increase or decrease his ground speed and pull power "on the go" without declutching.

Shifting from Hi to Lo decreases the ground travel speed 21.4 percent and provides up to 27.3 percent increase in pull power in any of the transmission speeds. Shifting from Hi to Lo provides approximately

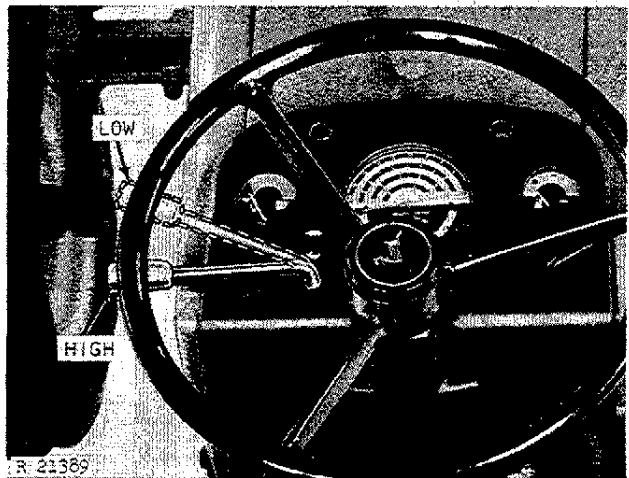

Hi-Lo Shift Lever

the same speed and pull power change as manually down-shifting one gear on the transmission.

REVERSER

The reverser allows the operator to change the direction of travel "on the go" without clutching or shifting gears.

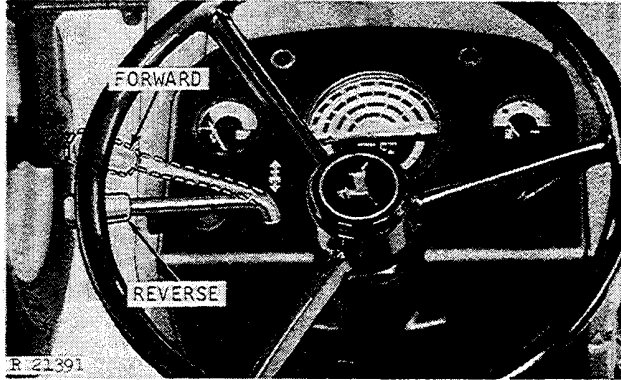

Reverser Control Lever

The reverser control lever is located at the left side of the instrument panel. When the lever is in the forward position, the tractor is in direct drive. When the lever is pulled rearward, the tractor is in reverse drive. It is not necessary to disengage clutch or to shift gears when using the reverser lever.

CAUTION: The reverser gear ratio is such that reverse speeds are higher than their respective forward speeds. Therefore, use care when changing direction, especially at higher travel speeds.

Reverser Speed-Of-Shift Adjustment

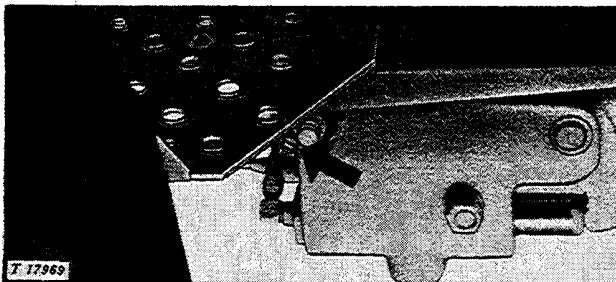

Reverser Speed-Of-Shift Adjusting Screw

The reverser may be adjusted for a firm rapid shift or for a slower shift.

The reverser speed-of-shift adjusting screw is located on the rear of the reverser control housing under the right footrest. Turn the adjusting screw clockwise to slow down the shift. Turn the screw counter-clockwise to speed up the shift.

NOTE: When the speed-of-shift screw is adjusted properly, the time to complete the shift should be 3/4 to 1-1/4 seconds.

HIGH SPEED DRIVING

Use 8th gear to save time when driving on highways or other smooth roads. But - BE CAREFUL! On rough ground, shift to a lower gear for safety.

CAUTION: Fast driving causes many accidents. Couple the brake pedals together and always drive at a safe speed. Do not allow tractor to coast downhill. Always keep clutch engaged and transmission in gear.

PARKING THE TRACTOR

To park the tractor, completely stop the tractor. Move the gear shift lever into any gear position. Then move the range shift lever into park (P) position.

To shift from park, first move the range shift lever slightly to the left, and then pull the lever back into neutral.

If the tractor is parked on a steep incline, place the gear shift lever in the 1-5 gear position to facilitate shifting out of park.

TOWING THE TRACTOR

CAUTION: Never tow the tractor at a speed greater than 15 miles per hour (24 kilometres per hour).

When towing a disabled tractor, move both the range and gear shift levers to the neutral position. This will prevent undue wear on transmission parts during towing.

Tow tractors (without Hi-Lo or Reverser) for starting in 6th, 7th, or 8th gear only.

IMPORTANT: Do not attempt to start a tractor with Hi-Lo shift or Reverser by towing. Doing so may damage the Hi-Lo or Reverser clutches in a very short distance.

DIFFERENTIAL LOCK

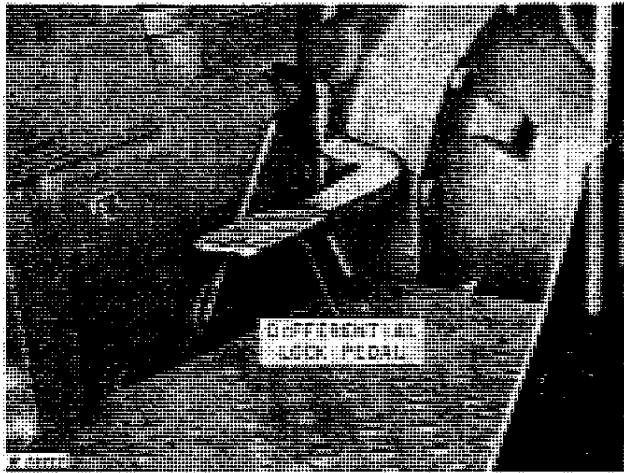

Differential Lock Pedal

Your tractor may be equipped with a differential lock that will turn both rear wheels at the same speed. This prevents the usual loss of power when one wheel is slipping.

CAUTION: Do not operate the tractor at high speeds or attempt to turn the tractor with the differential lock engaged.

To engage the differential lock, depress the operating pedal located on the left side of transmission case. Unequal traction will keep the lock engaged. When traction is equalized, the pedal will disengage itself by spring action.

If rear wheels slip, then get traction, then slip again, hold the pedal in the engaged position.

POWER STEERING

The tractor is equipped with power steering to make steering and control of the tractor easier for the operator. In case of oil pressure failure, the tractor can be steered manually.

HYDRAULIC BRAKES

The tractor is equipped with full hydraulic brakes.

To assist in making sharp turns, apply the brakes individually or, to stop the tractor, apply both brakes simultaneously. When traveling at high speeds, couple the pedals together and use a light pressure on the pedals.

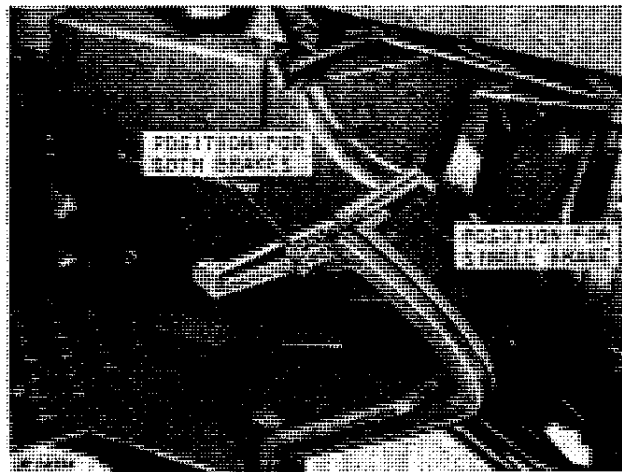

Brake Pedals

CAUTION: Fast driving causes many accidents. Couple the brake pedals together and always drive at a safe speed.

TOWED LOADS

CAUTION: Towed loads that weigh more than twice the weight of tractor should have brakes. If not, reduce speed and avoid inclines.

HYDRAULIC OIL SUPPLY

On tractors without independent PTO avoid prolonged disengagement of the transmission or PTO clutch, which controls transmission oil pump operation. Disengaging the clutch for longer periods reduces the supply of pressure oil for hydraulic functions.

FRONT WHEEL TREAD

Your tractor may be equipped with a heavy duty, straight, or swept-back adjustable front axle. The chart on page 15 lists the wheel tread ranges for different types of front axles.

Axle Type	Tire Size	Wheel Treads
Swept-back	6.00-16	49 to 74 inches
	7.5L-15	(1.24 to 1.88 m)*
	7.50-16	79 inches (2.00 m) maximum with wheels reversed
	27/9.5-15	50 to 75 inches (1.27 to 1.90 m)*
Straight	6.00-16	49 to 75 inches
	7.5L-15	(1.24 to 1.90 m)*
	7.50-16	81 inches (2.05 m) maximum with wheels reversed
	7.50-16	53.5 to 73.5 inches (1.359 to 1.867 m)*** 79 inches maximum with wheels reversed
Extra wide straight	6.00-16	60 to 88 inches
	7.5L-15	(1.52 to 2.24 m)**
	7.50-16	93 inches (2.36 m) maximum with wheels reversed
Heavy duty adjustable	7.5L-15	53 to 73 inches
	7.50-16	(1.35 to 1.85 m)***
	9.5L-15	
	11L-15	55 to 75 inches (1.40 to 1.91 m)***

*Adjustable in 1.89-inch (4.8 cm) steps.
 **Adjustable in 2-inch (5.1 cm) steps.
 ***Adjustable in 4-inch (10.1 cm) steps.

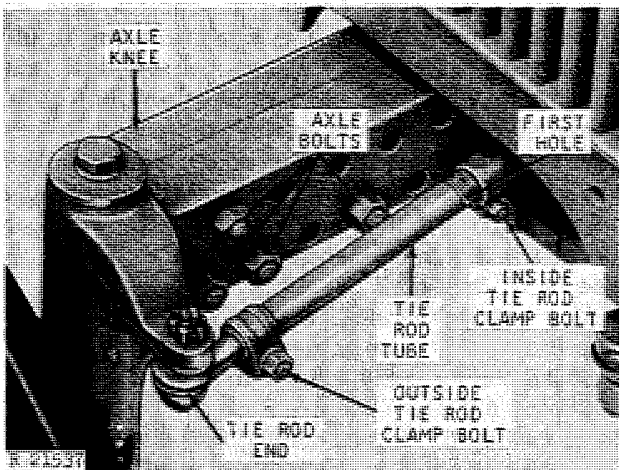

Front Wheel Tread Adjustment
(Heavy Duty Axle)

To adjust the front axle tread, raise the front end of tractor just enough to remove the tractor weight from tires. Remove the axle bolts and the outside tie rod clamp bolts.

Slide the axle knees in or out to desired position. Be sure that axle knee and tie rod end are moved the same distance to keep the wheels in

correct position. The outside tie rod clamp bolt can only be installed in clamp when "half-circle" notches on bottom side of tie rod end are in line with hole in clamp. The half-circle notches are spaced 1-inch (2.54 cm) apart to correspond with the 1-inch (2.54 cm) bolt hole spacing in axle. Heavy-duty front axles use a two-inch (5.08 cm) spacing on the tie rod end to correspond with the two-inch (5.08 cm) bolt hole spacing in axle. Normally, both axle knees should be positioned an equal distance from the center line of tractor.

After axle knees have been moved to the desired position, install axle bolts using a 4-inch (10.16 cm) bolt spacing in maximum tread width position, and a 6-inch (15.24 cm) bolt spacing in all other positions. Tighten axle bolts to 300 ft-lbs (406 Nm) torque, and tighten the outside tie rod clamp bolts to 60 ft-lbs (81 Nm) torque. Check toe-in adjustment.

IMPORTANT: Do not separate axle knees beyond limits given in tread chart on previous page. Do not unscrew threaded portion of tie rod tube beyond second hole. Tractors being operated with heavy front end loads (such as a loader) should not have front wheels reversed.

Toe-In Adjustment

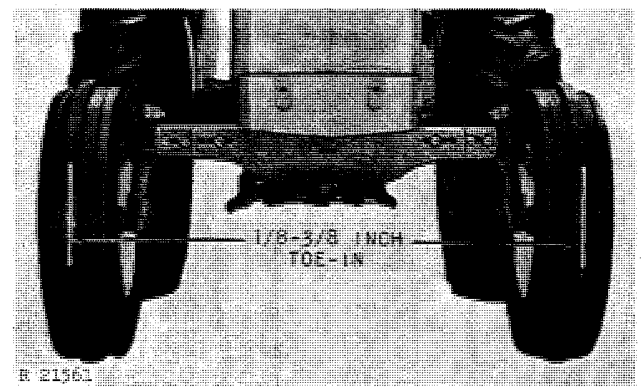

Correct Toe-In

Toe-in of the front wheels should be 1/8 to 3/8 inch (3.2 to 9.5 mm).

To check toe-in, turn the steering wheel until the front wheels point straight ahead, parallel to the center line of the tractor. Measure the distance from tire to tire, first at the front of the tires and then at the rear. Front measurement should be 1/8 to 3/8 inch (3.2 to 9.5 mm) less than rear measurement.

To adjust, loosen both clamps on each tie rod tube. Turn both tie rod tubes an equal amount until toe-in is correct. Both front wheels must have equal toe-in. Tighten inner and outer tie rod clamps to 55 ft-lbs (75 Nm) torque.



Suggest:

If the above button click is invalid.

Please download this document

first, and then click the above link

to download the complete manual.

Thank you so much for reading

Front Wheel Retainers

Periodically check the tightness of the front wheel hub cap screws. If necessary, retighten wheel-to-hub screws evenly to 100 ft-lbs (136 Nm).

IMPORTANT: During break-in, retighten all front wheel retainers evenly after the first 4 hours and again after 8 hours of operation. Check tightness of retainers frequently during the first 100 hours of operation.

REAR WHEEL TREAD

CAUTION: NEVER operate tractor with a loose wheel, rim, or hub.

Rear wheel tread may be varied by changing the rim or wheel position. The method used for changing the wheel tread will depend upon whether the tractor has a rack and pinion or a flanged axle; demountable rim, steel disk, cast, or power adjusted wheels.

The tread ranges also vary with the type of wheel and axle used. Use the charts on the following pages for rear wheel tread specifications.

CAUTION: Do not remove fenders to obtain narrower tread settings.

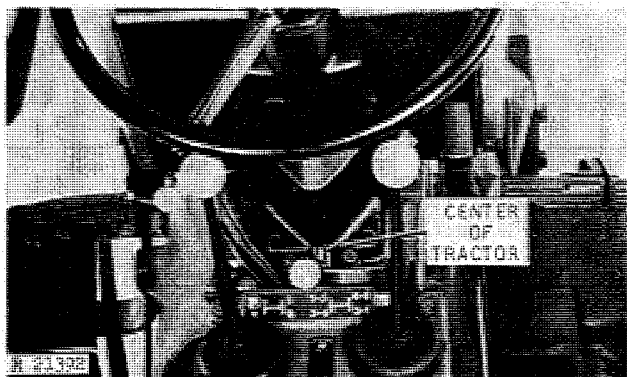

Center of Tractor

Measure the distance from the center of the tractor to the center of the rear tire. This distance should be the same for both sides of the tractor.

Adjusting Wheel on Rack and Pinion Axle

Turning a pinion gear in the wheel hub that engages a rack on the axle moves this type of wheel in or out. See illustration. This adjustment may be made with one or two wheel weights installed.

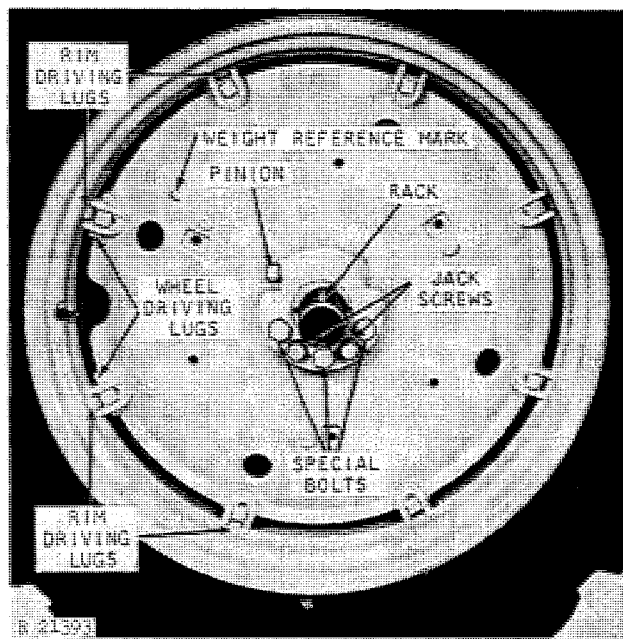

Rack and Pinion Adjustment

With the rack on top of the axle, loosen the three special bolts 3/8 inch (9.5 mm). Loosen the tapered sleeve by turning the two jack screws clockwise until the inner edge of the hex. surface is flush with the hub surface. Jack up the tractor and turn the pinion gear to slide the wheel in or out on the axle.

IMPORTANT: Tires or weights should have at least one inch (2.5 cm) clearance with the fenders. Setting the wheels too close to the rear axle housing may damage the pinion when the hub is tightened. To avoid this, adjust the wheel to the innermost position until the pinion contacts the end of the rack. Then back up until the wheel has moved outward at least 1/8-inch (3.2 mm) or more if needed for fender clearance. Rack on axle must be up.

After the desired tread is obtained, back the jack screws all the way out against the stop. Do not force. Lubricate the threads and tighten the special bolts to 300 ft-lbs (407 Nm) torque. Retighten bolts several times until all three bolts stay tightened to 300 ft-lbs (407 Nm) torque. The jack screws must be free to turn after the hub is tightened. If necessary, back the jack screws out a little further and retighten special bolts.

Adjust the other wheel in the same manner. Normally, both wheels are set the same distance from the tractor center line. AFTER driving tractor for approximately 20 revolutions of the wheel and BEFORE working, retighten the special bolts to 300 ft-lbs (407 Nm) torque. After working tractor for approximately 3 hours and again at 10 hours, retighten the special bolts and keep them tight.

<https://www.ebooklibonline.com>

Hello dear friend!

Thank you very much for reading.

Enter the link into your browser.

The full manual is available for immediate download.

<https://www.ebooklibonline.com>