

**JOHN DEERE**  
**WORLDWIDE COMMERCIAL & CONSUMER**  
**EQUIPMENT DIVISION**

---

**Basic Machines**  
**1505 - 1515**

OMTCU30340 B1

**OPERATOR'S MANUAL**



**JOHN DEERE**

Export Version  
Litho in U.S.A.

# Introduction

---

## Thank You for Purchasing a John Deere Product

We appreciate having you as a customer and wish you many years of safe and satisfied use of your machine.

## Using Your Operator's Manual

This manual is an important part of your machine and should remain with the machine when you sell it.

Reading your operator's manual will help you and others avoid personal injury or damage to the machine. Information given in this manual will provide the operator with the safest and most effective use of the machine. Knowing how to operate this machine safely and correctly will allow you to train others who may operate this machine.

If you have an attachment, use the safety and operating information in the attachment operator's manual along with the machine operator's manual to operate the attachment safely and correctly.

This manual and safety signs on your machine may also be available in other languages (see your authorized dealer to order).

Sections in your operator's manual are placed in a specific order to help you understand all the safety messages and learn the controls so you can operate this machine safely. You can also use this manual to answer any specific operating or servicing questions. A convenient index located at the end of this book will help you to find needed information quickly.

The machine shown in this manual may differ slightly from your machine, but will be similar enough to help you understand our instructions.

RIGHT-HAND and LEFT-HAND sides are determined by facing in the direction the machine will travel when going forward. When you see a broken line (-----), the item referred to is hidden from view.

Before delivering this machine, your dealer performed a predelivery inspection to ensure best performance.

## Machine Use

This machine is designed solely for use in customary lawn mowing operations and winter work. Use in any other way is considered as contrary to the intended use.

This machine is not intended for use in forestry operations. The operator station does not provide adequate protection to the occupants in that environment.

The cab available from the manufacturer is not designed to provide adequate protection from hazardous substances.

The operator must wear appropriate personal protection equipment.

The manufacturer accepts no liability for damage or injury resulting from this misuse, and these risks must be borne solely by the user. Compliance with and strict adherence to the conditions of operation, service and repair as specified by the manufacturer also constitute essential elements for the intended use.

This machine should be operated, serviced and repaired only by persons familiar with all its particular characteristics and acquainted with the relevant safety rules (accident prevention). The accident prevention regulations, all other generally recognized regulations on safety and occupational medicine and the road traffic regulations must be observed at all times.

Setting fuel delivery beyond published factory specifications or otherwise overpowering will result in loss of warranty protection for this machine.

Any arbitrary modifications carried out on this machine will relieve the manufacturer of all liability for any resulting damage or injury.

## Special Messages

Your manual contains special messages to bring attention to potential safety concerns, machine damage as well as helpful operating and servicing information. Please read all the information carefully to avoid injury and machine damage.



**CAUTION: Avoid injury! This symbol and text highlight potential hazards or death to the operator or bystanders that may occur if the hazards or procedures are ignored.**

**IMPORTANT: Avoid damage! This text is used to tell the operator of actions or conditions that might result in damage to the machine.**

**NOTE: General information is given throughout the manual that may help the operator in the operation or service of the machine.**

# Product Identification

---

## Record Identification Numbers

1505 / 1505 Basic Machines: PIN (170001 - )

If you need to contact an Authorized Service Center for information on servicing, always provide the product model and serial number.

You will need to locate the model and serial number for the machine and for the engine of your machine and record the information in the spaces provided below.

DATE OF PURCHASE:

---

DEALER NAME:

---

DEALER PHONE:

---

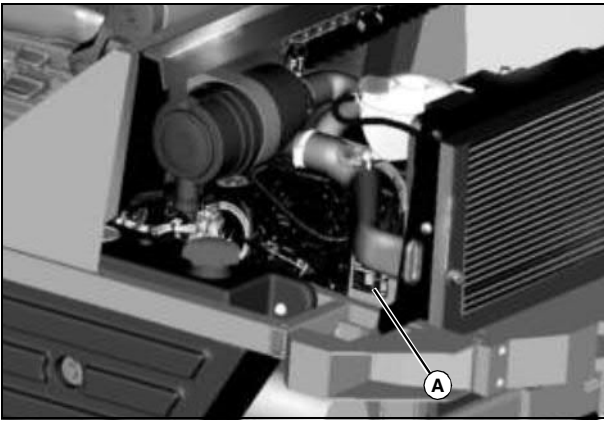

DM2966

PRODUCT IDENTIFICATION NUMBER (A):

---



DM2969

ENGINE SERIAL NUMBER (B):

---

**<https://www.ebooklibonline.com>**

Hello dear friend!

Thank you very much for reading.

Enter the link into your browser.

The full manual is available for immediate download.

**<https://www.ebooklibonline.com>**

# Table of Contents

---

Safety Labels .....	1
Safety .....	3
Operating Controls .....	9
Operating .....	14
Replacement Parts .....	22
Service Intervals .....	23
Service Lubrication .....	24
Service Engine .....	25
Service Transmission .....	32
Service Electrical .....	35
Service Miscellaneous .....	38
Troubleshooting .....	41
Storage .....	47
Assembly .....	48
Specifications .....	50
Declaration of Conformity .....	52
Index .....	53

Original Instruction

All information, illustrations and specifications in this manual are based on the latest information at the time of publication. The right is reserved to make changes at any time without notice.

COPYRIGHT© 2011

Deere & Co.

John Deere Worldwide Commercial and Consumer Equipment Division

All rights reserved

Previous Editions

COPYRIGHT©

OMTCU30340 B1 -

## Safety Labels



### Pictorial Safety Signs

At several important places on this machine safety signs are affixed intended to signify potential danger. The hazard is identified by a pictorial in a warning triangle. An adjacent pictorial provides information how to avoid personal injury. These safety signs, their placement on the machine and a brief explanatory text are shown in this Safety section.

There can be additional safety information contained on parts and components sourced from suppliers that is not reproduced in this operator's manual.

### Read Operators Manual

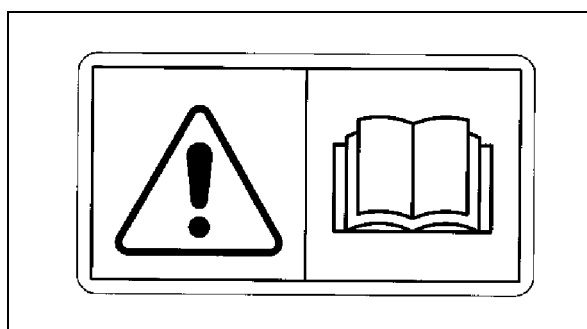

DM0142

This operator's manual contains important information necessary for safe machine operation. Observe all safety rules to avoid accidents.

### Avoid Injury from Tipping (Machine equipped with Cab) - DM0143

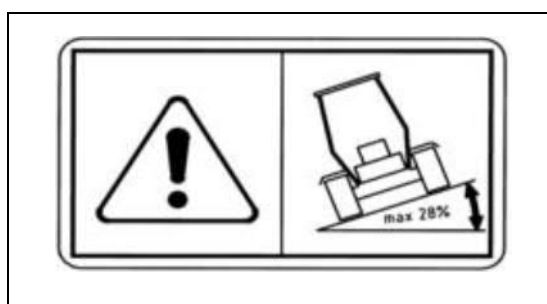

DM0143

Do not use mower on inclines with an angle exceeding 28%.

### Warning (Machine equipped with ROPS) - TCU30379

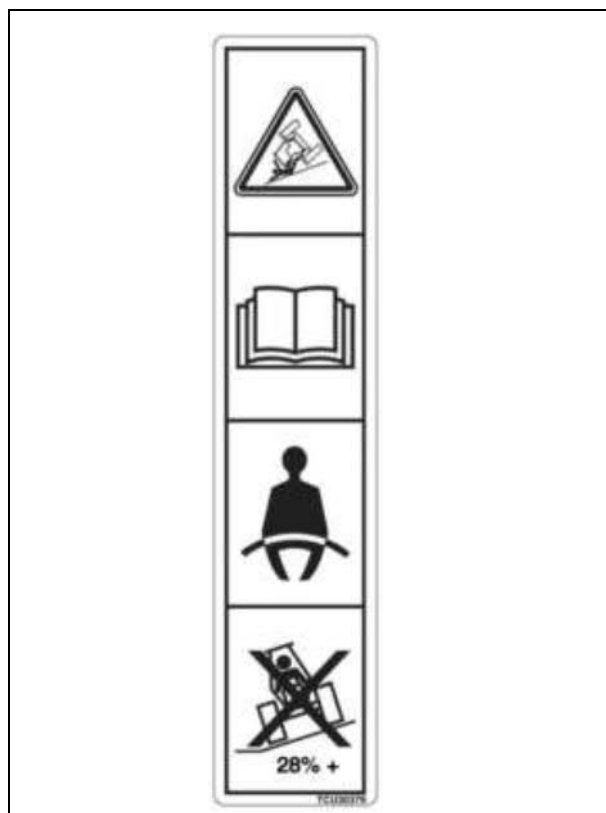

TCU30379

- To avoid injury from crushing, always wear seat belt. Do not jump from machine.
- Read the Operator's Manual.
- Always use seat belt.
- Do not operate on a slope greater than 28%.

### Avoid Injury from Fan - DM0968

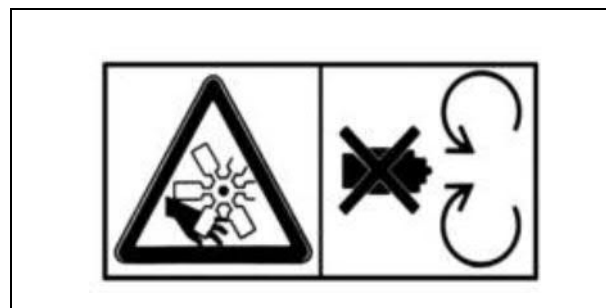

DM0968

Do not open or remove safety shields while engine is running.

## Safety Labels

### Avoid Injury from Battery Gases and Acids

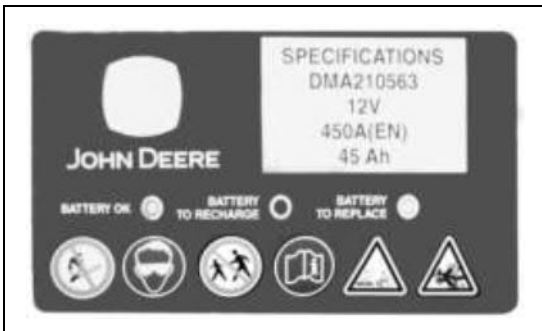

DM2970

- Do not smoke and keep fire away from battery.
- Wear eye protection and gloves when performing maintenance on the battery.
- Keep children away from battery when performing maintenance on the battery
- Do not spill electrolyte on skin
- Read manual before performing maintenance on battery.
- Batteries produce a flammable and explosive gas.

### Avoid Injury from Radiator, Coolant Gases and Fluids

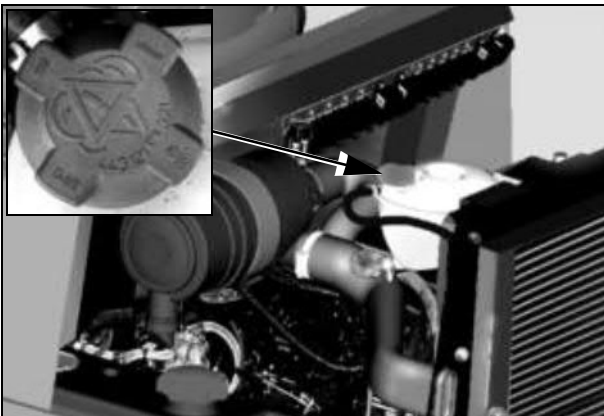

DM1132, DM2966

Read manual before opening cap.

### CE Certification, Specification and Sound Labels

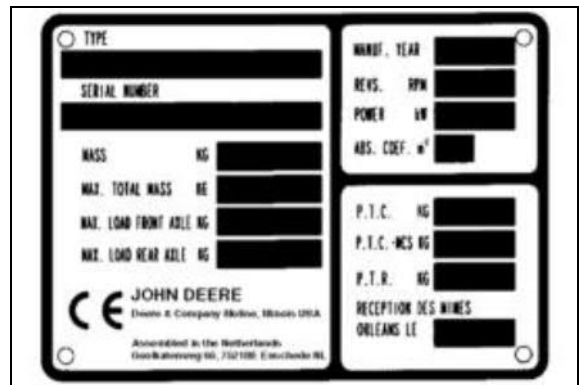

DM2985

This information is provided on your machine to indicate the machine is certified and in compliance with European Directive Standards: 2006/42/EC.

---

# Safety

---

## Training

- Read the instructions carefully. Be familiar with the controls and the proper use of the equipment.
- Never allow children or people unfamiliar with these instructions to use the lawnmower. Local regulations can restrict the age of the operator.
- Never mow while people, especially children, or pets are nearby.
- Keep in mind that the operator or user is responsible for accidents or hazards occurring to other people or their property.
- Do not carry passengers.
- All drivers should seek and obtain professional and practical instruction. Such instruction should emphasize:
  - the need for care and concentration when working with ride-on machines.
  - control of a ride-on machine sliding on a slope will not be regained by the application of the brake.
- The main reasons for loss of control are:
  - insufficient wheel grip;
  - being driven too fast;
  - inadequate braking;
  - the type of machine is unsuitable for its task;
  - lack of awareness of the effect of ground conditions, especially slopes;
  - incorrect hitching and load distribution.

## Preparation

- While mowing, always wear substantial footwear and long trousers. Do not operate the equipment when barefoot or wearing open sandals.
- Thoroughly inspect the area where the equipment is to be used and remove all objects which can be thrown by the machine.
- **WARNING-Fuel is highly flammable.**
  - store fuel in containers specifically designed for this purpose.
  - refuel outdoors only and do not smoke while refueling.
  - add fuel before starting the engine. Never remove the cap of the fuel tank or add fuel while the engine is running or when the engine is hot.
  - if fuel is spilled, do not attempt to start the engine but move the machine away from the area of spillage and

avoid creating any source of ignition until fuel vapors have dissipated.

- replace all fuel tank and container caps securely.
- Replace faulty silencers.
- Before using, always visually inspect to see that the blades, blade bolts and cutter assembly are not worn or damaged. Replace worn or damaged blades and bolts in sets to preserve balance.
- On multi-bladed machines, take care as rotating one blade can cause other blades to rotate.

## Operation

- Do not operate the engine in a confined space where dangerous carbon monoxide fumes can collect.
- Mow only in daylight or in good artificial light.
- Before attempting to start the engine, disengage all blade attachment clutches and shift into neutral.
- Do not use on slopes of degrees more than recommended by the manufacturer.
- Remember there is no such thing as a safe slope. Travel on grass slopes requires particular care. To guard against overturning:
  - do not stop or start suddenly when going up or downhill;
  - engage clutch slowly, always keep machine in gear, especially when traveling downhill;
  - machine speeds should be kept low on slopes and during tight turns;
  - stay alert for humps and hollows and other hidden hazards;
  - never mow across the face of a slope, unless the machine is designed for this purpose.
- Use care when pulling loads or using heavy equipment:
  - use only approved drawbar hitch points;
  - limit loads to those you can safely control;
  - do not turn sharply. Use care when reversing;
  - use counterweights or wheel weights when suggested in the operator's manual.
- Watch out for traffic when crossing or near roadways.
- Stop the blades from rotating before crossing surfaces other than grass.
- Never direct discharge of material toward bystanders nor allow anyone near the machine while in operation.
- Never operate the machine with defective guards, or

# Safety

---

without safety protective devices in place.

- Do not change the engine governor settings or overspeed the engine. Operating the engine at excessive speed can increase the hazard of personal injury.
- Before leaving the operator's position:
  - disengage the drive to any attachments and lower them;
  - change into neutral and lock the parking brake;
  - stop the engine and remove the key.
- Disengage drive to attachments, stop the engine, disconnect the spark plug wires and remove the ignition key:
  - before clearing blockages or unclogging chute;
  - before checking, cleaning, or working on the machine;
  - after striking a foreign object. Inspect the machine for damage and make repairs before restarting and operating the equipment;
  - if the machine starts to vibrate abnormally (check immediately).
- Disengage drive to attachments when transporting or not in use.
- Stop the engine and disengage drive to attachment:
  - before refueling;
  - before removing the grass catcher;
  - before making height adjustment unless adjustment can be made from the operator's position.
- Reduce the throttle setting during run-out and, if the engine is provided with a shut-off valve, turn the fuel off at the conclusion of mowing.
- Read, understand and follow all instructions in the manual and on the machine before starting.
- Inspect machine before you operate. Repair or replace damaged, badly worn, or missing parts. Make any necessary adjustments before you operate.
- Be sure all drives are in neutral and parking brake is locked before starting engine. Only start engine from the operator's position.
- Do not operate mower without discharge chute or entire grass catcher in place. Never operate with the discharge deflector raised, removed, or altered, unless using a grass catcher.
- Check brake action before you operate. Adjust or service brakes as necessary.
- Stop machine if anyone enters the area.
- Do not leave machine unattended when it is running.

- Use care when approaching blind corners, shrubs, trees, or other objects that may obscure vision.
- Use only accessories and attachments approved by the manufacturer of the machine. Keep safety labels visible when installing accessories and attachments.
- Do not operate machine if you are under the influence of drugs or alcohol.
- Check before each use that operator presence controls are functioning correctly. Test safety systems. Do not operate unless they are functioning correctly.
- Never raise mower decks when blades are running.
- Do not wear radio or music headphones. Safe service and operation requires your full attention.

## Maintenance and Storage

- Keep all nuts, bolts and screws tight to be sure the equipment is in safe working condition.
- Never store the equipment with fuel in the tank inside a building where fumes can reach an open flame or spark.
- Allow the engine to cool before storing in any enclosure.
- To reduce the fire hazard, keep the engine, silencer, battery compartment and fuel storage area free of grass, leaves, or excessive grease.
- Check the grass catcher frequently for wear or deterioration.
- Replace worn or damaged parts for safety.
- If the fuel tank has to be drained, this should be done outdoors.
- On multi-bladed machines, take care as rotating one blade can cause other blades to rotate.
- When machine is to be parked, stored or left unattended, lower the cutting means unless a positive mechanical lock is used.
- Use jack stands or lock service latches to support components when required. Securely support any machine elements that must be raised for service work.
- Before servicing machine or attachment, carefully release pressure from any components with stored energy, such as hydraulic components or springs.
- Release hydraulic pressure by lowering attachment or cutting units to the ground or to a mechanical stop and move hydraulic control levers back and forth.
- Disconnect battery or remove spark plug (for gas engines) before making any repairs. Disconnect the negative terminal first and the positive last. Reconnect positive first and negative last.

# Safety

- Use care when checking blades. Wrap the blades or wear gloves, and use caution when servicing them. Only replace blades. Never straighten or weld them.
- Keep hands, feet, clothing, jewelry and long hair away from moving parts. If possible, do not make adjustments with the engine running.
- Charge batteries in an open well ventilated area, away from spark and flames. Unplug charger before connecting or disconnecting from battery. Wear protective clothing and use insulated tools.

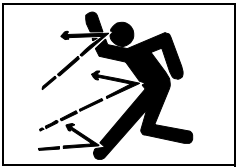

## Checking Mowing Area

- Clear mowing area of objects that might be thrown. Keep people and pets out of mowing area.
- Low-hanging branches and similar obstacles can injure the operator or interfere with mowing operation. Before mowing, identify potential obstacles such as low-hanging branches, and trim or remove those obstacles.
- Study mowing area. Set up a safe mowing pattern. Do not mow where traction or stability is doubtful.
- Test drive area with mower lowered but not running. Slow down when you travel over rough ground.

## Parking Safely

1. Stop machine on a level surface, not on a slope.
2. Disengage mower blades or any other attachments.
3. Lower attachments to the ground.
4. Lock the park brake.
5. Stop the engine.
6. Remove the key.
7. Wait for engine and all moving parts to stop before you leave the operator's seat.
8. Close fuel shut-off valve, if your machine is equipped.
9. Disconnect the negative battery cable or remove the spark plug wire(s) (for gasoline engines) before servicing the machine.

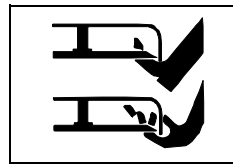

## Rotating Blades are Dangerous

### HELP PREVENT SERIOUS OR FATAL ACCIDENTS:

- Rotating blades can cut off arms and legs, and throw objects. Failure to observe safety instructions could result in serious injury or death.
- Keep hands, feet and clothing away from mower deck when engine is running.
- Be alert at all times, drive forward carefully. People, especially children can move quickly into the mowing area before you know it.
- Do not mow in reverse.
- Shut off blades when you are not mowing.
- Park machine safely before leaving the operator station for any reason including emptying the catchers or unplugging the chute.

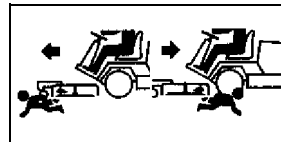

## Protect Children

- Death or serious injury can occur when young children associate having fun with a lawn mowing machine simply because someone has given them a ride on a machine.
- Children are attracted to lawn mowing machines and mowing activities. They don't understand the dangers of rotating blades or the fact that the operator is unaware of their presence.
- Children who have been given rides in the past may suddenly appear in the mowing area for another ride and be run over or backed over by the machine.
- Tragic accidents with children can occur if the operator is not alert to the presence of children, especially when a child approaches a machine from behind. Before and while backing up, stop mower blades and look down and behind the machine carefully, especially for children.
- Never carry children on a machine or attachment, even with the blades off. Do not tow children in a cart or trailer. They can fall off and be seriously injured or interfere with safe machine operation.
- Never use the machine as a recreational vehicle or to entertain children.
- Never allow children or an untrained person operate the machine. Instruct all operators not to give children a ride on the machine or in an attachment.
- Keep children indoors, out of the mowing area, and in the watchful eye of a responsible adult, other than the operator,

---

# Safety

---

when a mower is being operated.

- Stay alert to the presence of children. Never assume that children will remain where you last saw them. Turn the machine off if a child enters the work area.

## Avoid Tipping

- Slopes are a major factor related to loss-of-control and tip-over accidents, which can result in severe injury or death. Operation on all slopes requires extra caution.
- Mow across slopes, not up and down.
- Never mow on any slope that is more than 10 degrees, or a slope that rises more than 3-1/2 feet within a distance of 20 feet of distance.
- Make a safe choice when operating on slopes. If you feel uncomfortable on a hillside, or if you feel the front of the machine start to creep down the slope, stop mowing immediately and proceed slowly and safely down the slope.
- If steering direction cannot be maintained with slight steering corrections, the slope is too steep to mow.
- Watch for holes, ruts, bumps, rocks, or other hidden objects. Uneven terrain could overturn the machine. Tall grass can hide obstacles.
- Choose a low ground speed so you will not have to stop or shift while on a slope.
- Do not mow or operate machine on wet grass. Tires may lose traction. Tires may lose traction on slopes even though the brakes are functioning properly.
- Avoid starting, stopping or turning on a slope. If the tires lose traction, disengage the blades and proceed slowly, straight down the slope.
- Keep all movement on slopes slow and gradual. Do not make sudden changes in speed or direction, which could cause the machine to roll over.
- Use extra care while operating machine with grasscatchers or other attachments, they can affect stability of the machine. Do not use on steep slopes.
- Do not mow near drop-offs, ditches, embankments, or bodies of water. The machine could suddenly roll over if a wheel goes over the edge or the edge caves in.
- Leave at least the width of the machine as a safety area between the machine and any safety hazard. Mow those areas with a hand-held trimmer or walk-behind mower.
- Follow the manufacturer's recommendations for wheel weights or counterweights for added stability when operating on slopes or using front or rear mounted attachments. Remove weights when not required.
- Drive machine slowly and avoid quick stops if attachment

has been removed for servicing mower or machine.

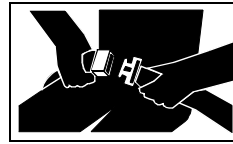

## Use Seat Belt Properly

- Use a seat belt when you operate with a Roll-Over Protective Structure (ROPS) to minimize chance of injury from an accident, such as an overturn.
- Do not use a seat belt if operating with an optional folding ROPS in the folded position. Return the folding ROPS to the upright position as soon as possible.
- Never modify, disassemble or attempt to repair the seat belt.
- Replace entire seat belt if mounting hardware, buckle, belt, or retractor show signs of damage.
- Inspect seat belt and mounting hardware at least once a year. Look for signs of loose hardware or belt damage, such as cuts, fraying, extreme or unusual wear, discoloration, or abrasion. Replace only with John Deere-approved replacement parts.
- Layers of heavy clothing can interfere with proper positioning of the seat belt and can reduce the effectiveness of the seat belt.

## Keep ROPS Installed Properly

- Never operate the machine without the ROPS installed.
- Make certain all parts of the ROPS are installed correctly if the ROPS structure is loosened or removed for any reason. All ROPS hardware should be tightened to the proper torque per manufacturer's recommendations.
- Any alteration of the ROPS must be approved by the manufacturer. The protection provided by the ROPS will be impaired if the ROPS is subjected to structural damage, is involved in an overturn incident, or is in any way altered by welding, bending, drilling, or cutting.
- The seat is part of the ROPS safety zone. Replace only with John Deere-approved seat.
- Never attempt to repair a damaged or altered ROPS. It must be replaced to maintain the manufacturer's certification of the structure.

## Keep Riders Off

- Only allow the operator on the machine. Keep riders off.
- Riders on the machine or attachment may be struck by foreign objects or thrown off the machine causing serious

# Safety

injury.

- Riders obstruct the operator's view resulting in the machine being operated in an unsafe manner.

## Towing Loads Safely

- Stopping distance increases with speed and weight of towed load. Travel slowly and allow extra time and distance to stop.
- Total towed weight must not exceed combined weight of pulling machine, ballast and operator. Use counterweights or wheel weights as described in the attachment or pulling machine operator's manual.
- Excessive towed load can cause loss of traction and loss of control on slopes. Reduce towed weight when operating on slopes.
- Never allow children or others in or on towed equipment.
- Use only approved hitches. Tow only with a machine that has a hitch designed for towing. Do not attach towed equipment except at the approved hitch point.
- Follow the manufacturer's recommendations for weight limits for towed equipment and towing on slopes.
- If you cannot back up a slope with a towed load, the slope is too steep to operate on with the towed load. Reduce the towed load or do not operate.
- Do not turn sharply. Use additional caution when turning or operating under adverse surface conditions. Use care when reversing.
- Do not shift to neutral and coast downhill.

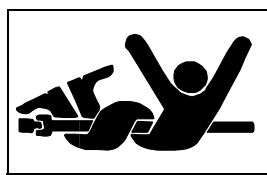

## Stay Clear of Rotating Drivelines

Entanglement in rotating driveline can cause serious injury or death.

- Wear close fitting clothing.

- Stop the engine and be sure PTO driveline is stopped before getting near it.



## Avoid High Pressure Fluids

Hydraulic hoses and lines can fail due to physical damage, kinks, age, and exposure. Check hoses and lines regularly. Replace damaged hoses

and lines.

- Hydraulic fluid connections can loosen due to physical

damage and vibration. Check connections regularly. Tighten loose connections.

- Escaping fluid under pressure can penetrate the skin causing serious injury. Avoid the hazard by relieving pressure before disconnecting hydraulic or other lines. Tighten all connections before applying pressure.
- Search for leaks with a piece of cardboard. Protect hands and body from high pressure fluids.
- If an accident occurs, see a doctor immediately. Any fluid injected into the skin must be surgically removed within a few hours or gangrene may result. Doctors unfamiliar with this type of injury should reference a knowledgeable medical source. Such information is available from Deere & Company Medical Department in Moline, Illinois, U.S.A. Information may be obtained in the United States and Canada only by calling 1-800-822-8262.

## Checking Wheel Hardware

- A serious accident could occur causing serious injury if wheel hardware is not tight.
- Check wheel hardware tightness often during the first 100 hours of operation.
- Wheel hardware must be tightened to specified torque using the proper procedure anytime it is loosened.

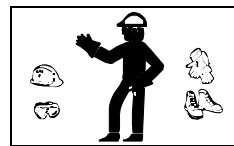

## Wear Appropriate Clothing

- Always wear safety goggles, or safety glasses with side shields when operating the machine.

- Wear close fitting clothing and safety equipment appropriate for the job.
- While operating this machine, always wear substantial footwear and long trousers. Do not operate the equipment when barefoot or wearing open sandals.
- Wear a suitable protective device such as earplugs. Loud noise can cause impairment or loss of hearing.



## Prevent Fires

Machine fires and structure fires can occur if a machine is stored before allowing it to cool, if debris is not removed from critical areas of the machine, or if machine is stored near combustible materials.

- Remove grass and debris completely from engine

# Safety

compartment and muffler area, and from on top of the mower deck, before and after operating machine, especially after mowing or mulching in dry conditions.

- Empty any grasscatcher bags or containers completely before storing.
- Always shut off fuel when storing or transporting machine, if the machine has a fuel shutoff.
- Do not store machine near an open flame or source of ignition, such as a water heater or furnace.
- Check fuel lines, tank, cap, and fittings frequently for cracks or leaks. Replace if necessary.



## Tire Safety

Explosive separation of a tire and rim parts can cause serious injury or death:

- Do not attempt to mount a tire without the proper equipment and experience to perform the job.
- Always maintain the correct tire pressure. Do not inflate the tires above the recommended pressure. Never weld or heat a wheel and tire assembly. The heat can cause an increase in air pressure resulting in a tire explosion. Welding can structurally weaken or deform the wheel.
- When inflating tires, use a clip-on chuck and extension hose long enough to allow you to stand to one side and NOT in front of or over the tire assembly.
- Check tires for low pressure, cuts, bubbles, damaged rims or missing lug bolts and nuts.

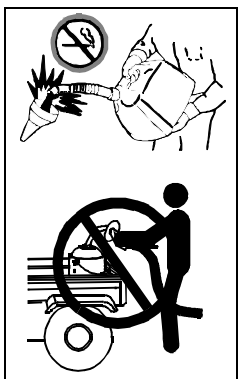

## Handling Fuel Safely

**To avoid personal injury or property damage, use extreme care in handling fuel. Fuel is extremely flammable and fuel vapors are explosive:**

- Extinguish all cigarettes, cigars, pipes, and other sources of ignition.
- Use only approved non-metal, portable fuel containers. If using a funnel, make sure it is plastic and has no screen or filter.
- Never remove the fuel tank cap or add fuel with the engine running. Allow engine to cool before refueling.
- Never add fuel to or drain fuel from the machine indoors. Move machine outdoors and provide adequate ventilation.
- Clean up spilled fuel immediately. If fuel is spilled on

clothing, change clothing immediately. If fuel is spilled near machine, do not attempt to start the engine but move the machine away from the area of spillage. Avoid creating any source of ignition until fuel vapors have dissipated.

- Never store the machine or fuel container where there is an open flame, spark, or pilot light such as on a water heater or other appliance.
- Prevent fire and explosion caused by static electric discharge. Static electric discharge can ignite fuel vapors in an ungrounded fuel container.
- Never fill containers inside a vehicle or on a truck or trailer bed with a plastic liner. Always place containers on the ground away from your vehicle before fueling.
- Remove fuel-powered equipment from the truck or trailer and refuel it on the ground. If this is not possible, then refuel such equipment with a portable container, rather than from a fuel dispenser nozzle.
- Keep the nozzle in contact with the rim of the fuel tank or container opening at all times until the fueling is complete. Do not use a nozzle lock-open device.
- Never overfill fuel tank. Replace fuel tank cap and tighten securely.
- Replace all fuel container caps securely after use.
- For gasoline engines, do not use gas with methanol. Methanol is harmful to your health and to the environment.

## Handling Waste Product and Chemicals

Waste products, such as, used oil, fuel, coolant, brake fluid, and batteries, can harm the environment and people:

- Do not use beverage containers for waste fluids - someone may drink from them.
- See your local Recycling Center or authorized dealer to learn how to recycle or get rid of waste products.
- See your local Recycling Center or authorized dealer to learn how to put your machine out of service at the end of the machine's service life.

# Operating Controls

## Operator Controls



DM2967

- A - Hour Meter
- B - Fuel Gauge
- C - Hydraulic Oil Temperature Gauge
- D - Water Temperature Gauge
- E - Water Temperature Gauge
- F - Engine Oil Pressure Lamp
- G - Hydraulic Oil Temperature Lamp
- H - Glow Indicator Lamp
- I - Turn Signal Lamp
- J - All Wheel Drive Lamp
- K - Forward / Reverse Pedal
- L - Steering Column Switch
- M - Hand Brake Lever
- N - Hydraulic Differential Lock Foot Switch
- O - Steering Column Tilt Lever Lock

# Operating Controls

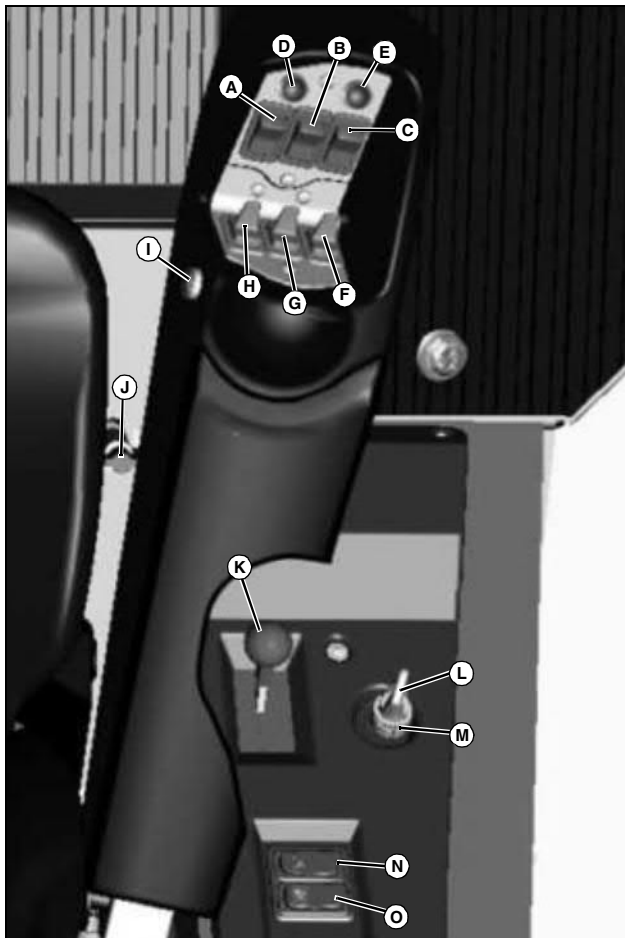

DM2971

- A - All Wheel Drive Switch
- B - Lower/Lock Switch
- C - Blades Switch
- D - Switch, shift attachment to left (Side Swing Option)
- E - Switch, shift attachment to right (Side Swing Option)
- F - Lower/Lift Switch for Wing Mower / Right Blade of 3 Meter Mower (Optional) / Right Blade of 223 Mower (Optional)
- G - Lower/Lift Front Mower Switch
- H - Lower/Lift Left Blade of 3 Meter Mower Switch (Optional)
- I - Cross Cut Switch
- J - Weight Transfer Valve Knob
- K - Throttle Lever
- L - Ignition Key
- M - Key Switch
- N - Hazard Lights Switch
- O - Parking Lights Switch

## Standard Seat



MX28223

- A - Seat Back Angle Lever
- B - Horizontal Shock Absorber
- C - Seat Adjustment Lever
- D - Seat Height Adjustment
- E - Seat Spring Adjustment Lever
- F - Folding Arm rests

## DeLuxe Seat

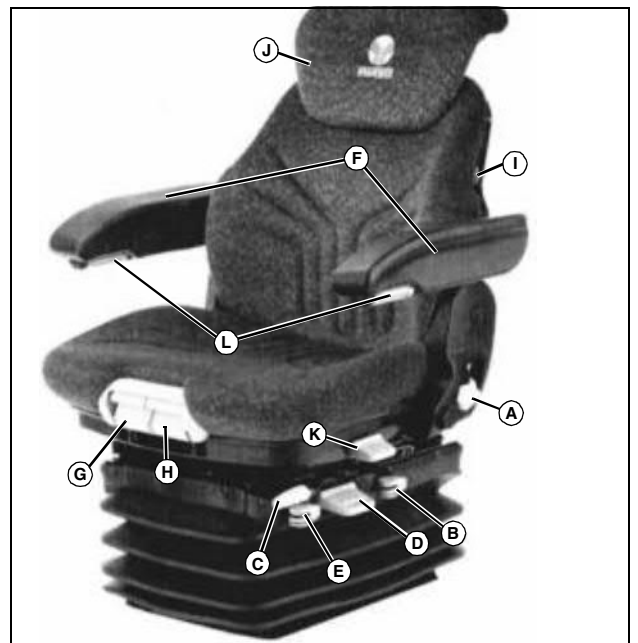

DM0014

# Operating Controls

- A - Seat Back Angle Lever
- B - Horizontal Shock Absorber
- C - Seat Adjustment Lever
- D - Seat Height Adjustment Lever
- E - Seat Spring Adjustment Lever
- F - Folding Arm Rests
- G - Seat Depth Adjustment
- H - Seat Pan Angle Adjustment
- I - Lumbar Support Adjustment
- J - Back Rest Adjustment
- K - Seat Swivel Adjustment
- L - Arm Rest Adjustment

## Adjusting Cab Mirrors

**IMPORTANT: Avoid damage! Cab mirrors must be adjusted to avoid contact with doors when opened.**

**NOTE: Mirrors have a swing-away feature that allows mirror arms to pivot if contact is made with a protruding object.**



MX9152

Pivot each mirror (A) to a desirable operating position. The line of sight to the rear and sides of the machine should be clearly visible from the operator's seat.

## Changing Wiper Blade

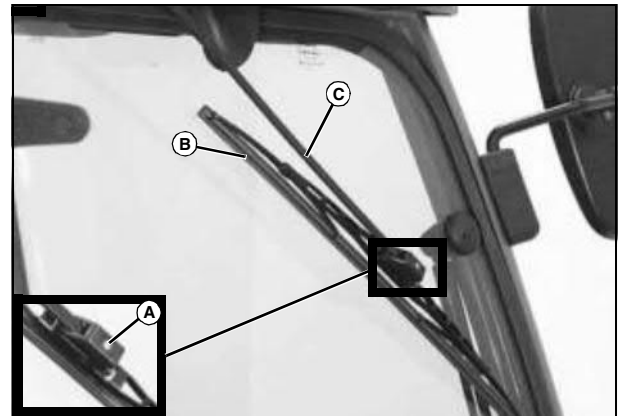

MX9151/MX9152

1. Remove set screw (A).
2. Carefully remove wiper blade (B) from the wiper arm (C).
3. Install new wiper blade.
4. Install set screw (A).
5. Check operation of wiper.

## Checking and Adjusting Cab Doors

**IMPORTANT: Avoid damage! Do not slam or forcefully latch doors into a closed position without checking the striker bolt adjustment.**

**NOTE: Each cab door striker bolt assembly can be adjusted.**

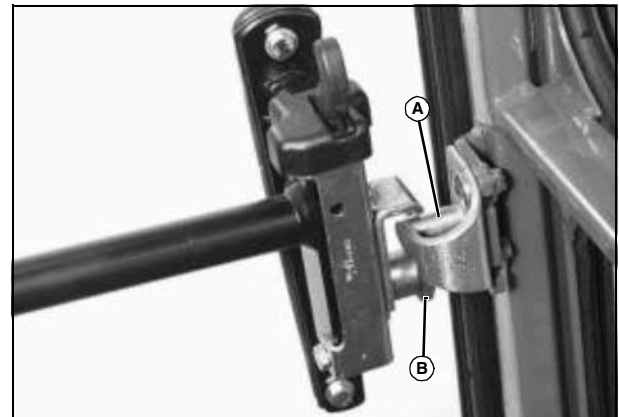

M9150

1. Park machine safely. (See Parking safely in the safety section.)
2. While seated in the machine, close each door only far enough to check the striker bolt (A) and door latch (B) alignment.
  - If adjusted properly, the striker bolt should pass through the center of the latch opening.

# Operating Controls

- If the adjusted position of the striker bolt is not correct, and adjustment is necessary.

## Adjust Striker Bolt

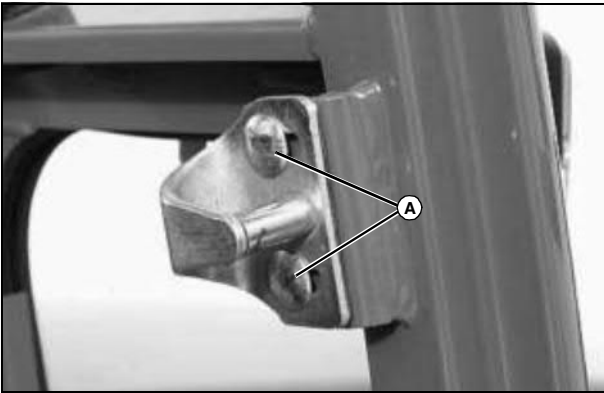

MX9149

1. Loosen hardware (A).
2. Move striker bolt left or right to adjust.
3. Tighten hardware.
4. Check and adjust each striker bolt as necessary.

## Opening Cab Doors

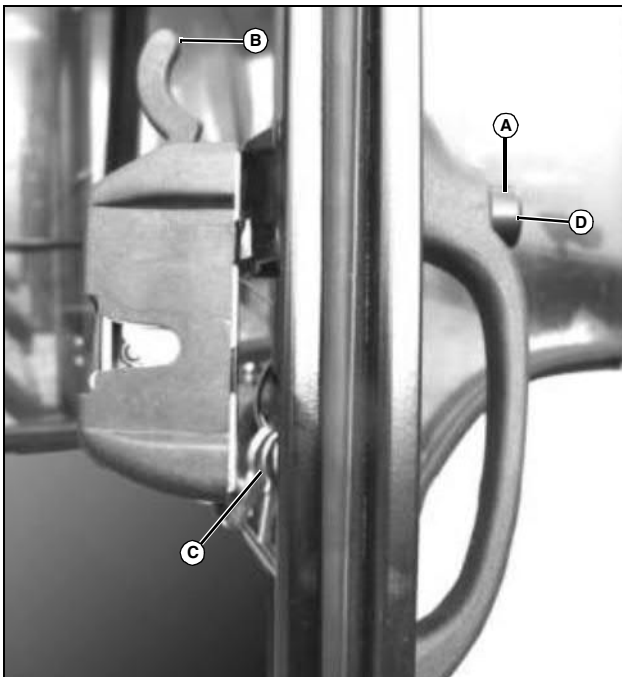

DM1419

## Locking Cab Doors

**NOTE:** Each cab door can be locked from outside the machine. Use key set (C) provided to prevent unauthorized entry.

1. Depress door handle button (A) to open cab door from outside the machine.

2. Pull lever (B) down to open cab door from inside the machine.
3. Insert key into door locking mechanism (D).
4. Rotate key 1/4 turn counterclockwise to lock door.
5. Remove key.

## Operating Cab Windows

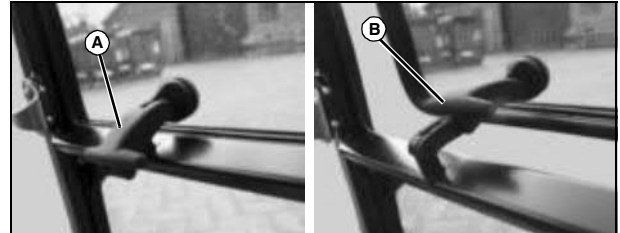

DM1421/DM1422

1. The cab front and rear windows can be set in two positions:

- Closed/locked position (A).
- Open/vent position (B).

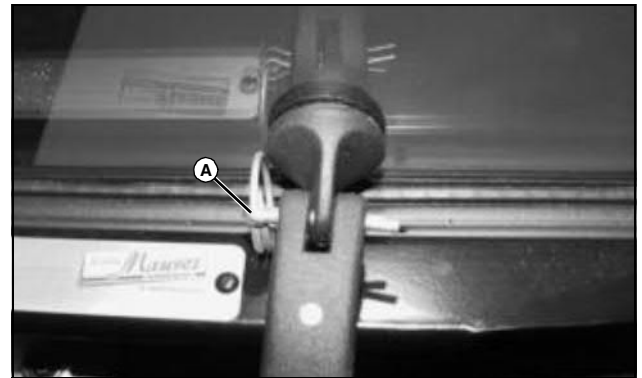

DM2980

**NOTE:** To enable the operator to leave the cab in case both doors are blocked, the front and rear window can be fully opened after pulling out the pins (A) of the window latches.

## Cab Controls (optional)

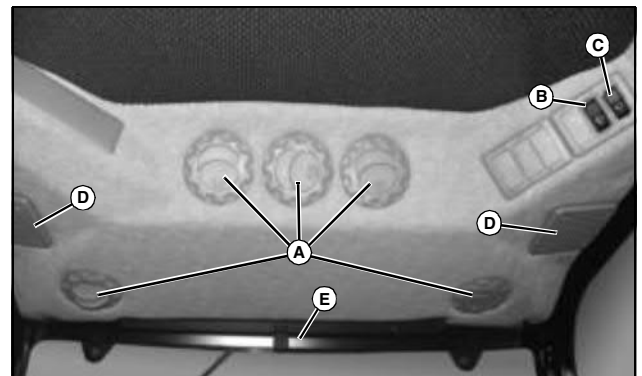

DM2972

## Operating Controls

---

- A - Air Diffusers
- B - Windshield Wash and Wipe Switch
- C - Windshield Wiper Switch
- D - Loudspeakers
- E - Sun Shade

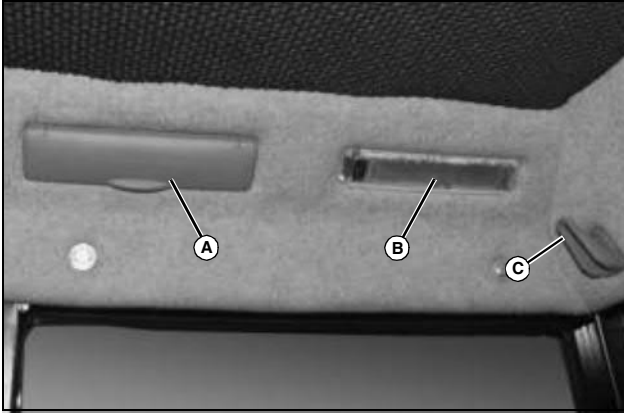

DM2974

- A - Fuse Box
- B - Interior Lamp
- C - Coat Hook

### A/C Controls (optional)

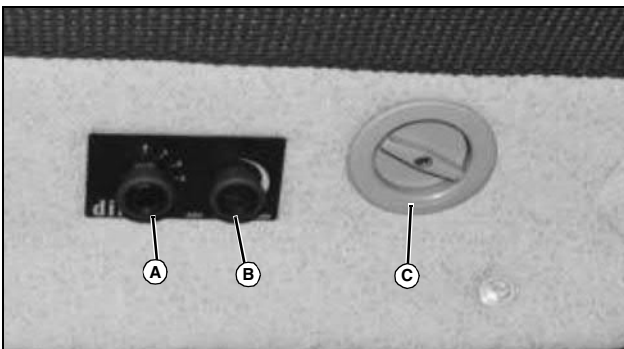

DM2973

- A - Fan Speed Switch
- B - Temperature Adjustment Switch
- C - Heater Shut Off Valve



**Suggest:**

**If the above button click is invalid.**

**Please download this document**

**first, and then click the above link**

**to download the complete manual.**

**Thank you so much for reading**

# Operating

## Daily Checklist

- Check tire pressure
- Check hydraulic oil level
- Check engine oil level
- Check coolant
- Test safety systems
- Remove grass and debris from machine
- Clean air intake screens for engine and oil cooler
- Check area below machine for leaks
- Check air restriction indicator
- Check fuel level
- Check fuel leakage (oil, fuel, coolant)
- Check for loose, missing or damaged parts.

## Avoid Damage to Plastic and Painted Surfaces

- Do not wipe plastic parts unless rinsed first. Using a dry cloth may cause scratches.
- Insect repellent spray may damage plastic and painted surfaces. Do not spray insect repellent near machine.
- Be careful not to spill fuel on machine. Fuel may damage surface. Wipe up spilled fuel immediately.
- Prolonged exposure to sunlight will damage hood surfaces.

## Using Seat Belt



**CAUTION: Avoid injury! Always wear a seat belt when operating machine with a Roll-Over Protective Structure (ROPS) or a cab. Do not jump from machine if machine tips.**



DM1253

1. Sit in seat.
2. Pull out seat belt buckle (A) and stretch across your lap.
3. Insert seat belt buckle into latch (B) until it locks.
4. To release seat belt, press red button (C) until buckle comes out of latch.

## Adjusting Standard Seat

### Adjusting Seat Position

1. Sit on seat.
2. Pull seat adjustment lever up, out of locked position.
3. Slide seat forward or rearward to desired position. Operator's right heel should be able to rest firmly on the floor in front of the pedal.
4. Release lever.

### Adjusting Seat Spring Tension

1. Turn seat spring knob to adjust seat spring tension while watching weight indicator.
2. Match weight of operator to value shown in weight indicator. Seat must spring slightly so that operator's presence switch will be activated, allowing engine to start.

### Adjusting Seat Height

1. Pull up seat base and latch seat into one of three positions. Lift seat beyond its highest position first to lower.

### Adjusting Seat Back

1. Pull up seat back angle lever and move seat back to desired position. Release lever.

### Adjusting Horizontal Absorber

1. Set horizontal absorber lever to the front to activate. Set lever to the rear to lock.

**<https://www.ebooklibonline.com>**

Hello dear friend!

Thank you very much for reading.

Enter the link into your browser.

The full manual is available for immediate download.

**<https://www.ebooklibonline.com>**