

JOHN DEERE
WORLDWIDE COMMERCIAL & CONSUMER
EQUIPMENT DIVISION

Bunker and Field Vehicle
1200A

SN (150001-)

OMTCU21792 A9

OPERATOR'S MANUAL

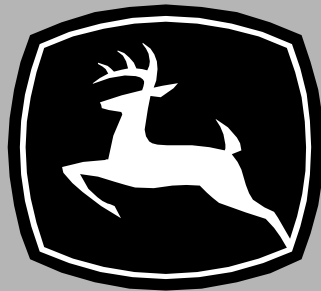

JOHN DEERE

⚠ WARNING: The Engine Exhaust from this product contains chemicals known to the State of California to cause cancer, birth defects or other reproductive harm.

California Proposition 65 Warning

North American Version
Litho in U.S.A.

INTRODUCTION

Thank You for Purchasing a John Deere Product

We appreciate having you as a customer and wish you many years of safe and satisfied use of your machine.

Using Your Operator's Manual

This manual is an important part of your machine and should remain with the machine when you sell it.

Reading your operator's manual will help you and others avoid personal injury or damage to the machine. Information given in this manual will provide the operator with the safest and most effective use of the machine. Knowing how to operate this machine safely and correctly will allow you to train others who may operate this machine.

If you have an attachment, use the safety and operating information in the attachment operator's manual along with the machine operator's manual to operate the attachment safely and correctly.

This manual and safety signs on your machine may also be available in other languages (see your authorized dealer to order).

Sections in your operator's manual are placed in a specific order to help you understand all the safety messages and learn the controls so you can operate this machine safely. You can also use this manual to answer any specific operating or servicing questions. A convenient index located at the end of this book will help you to find needed information quickly.

The machine shown in this manual may differ slightly from your machine, but will be similar enough to help you understand our instructions.

RIGHT-HAND and LEFT-HAND sides are determined by facing in the direction the machine will travel when going forward. When you see a broken line (-----), the item referred to is hidden from view.

Before delivering this machine, your dealer performed a predelivery inspection to ensure best performance.

Special Messages

Your manual contains special messages to bring attention to potential safety concerns, machine damage as well as helpful operating and servicing information. Please read all the information carefully to avoid injury and machine damage.



CAUTION: Avoid injury! This symbol and text highlight potential hazards or death to the operator or bystanders that may occur if the hazards or procedures are ignored.

IMPORTANT: Avoid damage! This text is used to tell the operator of actions or conditions that might result in damage to the machine.

NOTE: General information is given throughout the manual that may help the operator in the operation or service of the machine.

PRODUCT IDENTIFICATION

Record Identification Numbers

1200A PIN (0150001-)

If you need to contact an Authorized Service Center for information on servicing, always provide the product model and identification numbers.

You will need to locate the identification numbers for the product. Record the information in the spaces provided below.

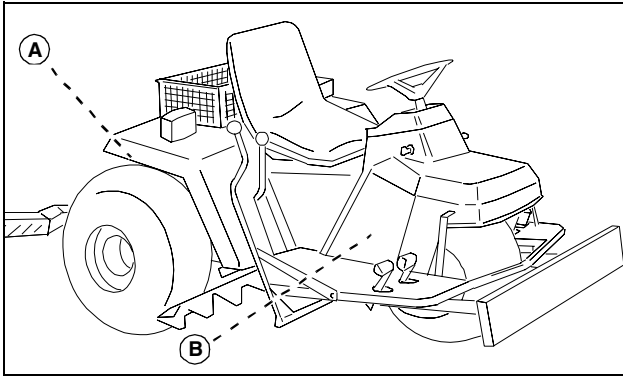

Mif

DATE OF PURCHASE:

DEALER NAME:

DEALER PHONE:

PRODUCT IDENTIFICATION NUMBER (A):

ENGINE SERIAL NUMBER (B):

<https://www.ebooklibonline.com>

Hello dear friend!

Thank you very much for reading.

Enter the link into your browser.

The full manual is available for immediate download.

<https://www.ebooklibonline.com>

TABLE OF CONTENTS

Safety	1
Safety Labels	5
Operating	7
Replacement Parts	13
Service Intervals	14
Service Lubrication	15
Service Engine	16
Service Transmission	20
Service Steering & Brakes	24
Service Electrical	26
Service Miscellaneous	29
Storage	31
Troubleshooting	33
Specifications	36
Warranty	38
Index	40

All information, illustrations and specifications in this manual are based on the latest information at the time of publication. The right is reserved to make changes at any time without notice.

COPYRIGHT© 2009

Deere & Co.

John Deere Worldwide Commercial and Consumer Equipment Division

All rights reserved

Previous Editions

COPYRIGHT© 2005, 1997, 1996, 1995 and 1994

OMTCU21792 A9 - English

SAFETY

Operator Training Required

- Read the operator's manual and other training material. If the operator or mechanic cannot read English, it is the owner's responsibility to explain this material to them. This publication is available in other languages.
- Become familiar with the safe operation of the equipment, operator controls, and safety signs.
- All operators and mechanics should be trained. The owner of the machine is responsible for training the users.
- Never let children or untrained people operate or service the equipment. Local regulations may restrict the age of the operator.
- The owner/user can prevent and is responsible for accidents or injuries occurring to themselves, other people, or property.
- Operate the machine in an open, unobstructed area under the direction of an experienced operator.

Operating Safely

- Only allow responsible adults, who are familiar with the instructions, to operate the machine.
- Inspect machine before you operate. Be sure hardware is tight. Repair or replace damaged, badly worn, or missing parts. Be sure guards and shields are in good condition and fastened in place. Make any necessary adjustments before you operate.
- Know location of controls and how and what they operate.
- Make sure spark plug, muffler, fuel cap and air cleaner are in place before starting the engine.
- Check before each use that operator presence controls are functioning correctly. Test safety systems. Do not operate unless they are functioning correctly.
- Slow down and be careful of traffic when operating near or crossing roadways. Use care when approaching blind corners, shrubs, trees, or other objects that may obscure vision.
- Sit on the center of the seat and keep both feet within the foot platform perimeter. Clean foot platform if dirty, and remove any debris from around foot controls.
- Always use both hands for steering.
- Do not change the engine governor setting or overspeed the engine.
- Check brake action before beginning vehicle operation. Adjust or service the brakes as necessary.
- If you hit an object or if abnormal vibration occurs, stop the machine and inspect it. Make repairs before you operate. Keep machine and attachments properly

maintained and in good working order.

- To provide adequate braking ability and traction, do not tow any attachment that is heavier than the weight of the machine.
- Do not leave vehicle unattended when it is running.
- Operate during daylight or with good artificial light and if you drive at night, use the lights.
- Do not operate vehicle if under the influence of alcohol or other drugs.
- Avoid sudden starts, stops, or turns.
- Do not wear radio or music headphones. Safe service and operation requires your full attention.
- Use only accessories and attachments approved by the manufacturer of the machine. Keep safety labels visible when installing accessories and attachments.
- The machine is not intended for use on public roads. It is to be used for off-road use only.
- Use extra care when loading or unloading the machine into a trailer or a truck.
- If the engine is provided with a fuel shut-off valve, turn the fuel off when not operating and before transporting on a trailer.

Using a Spark Arrestor

The engine in this machine is not equipped with a spark arrestor muffler. It is a violation of California Public Resource Code Section 4442 to use or operate this engine on or near any forest-covered, brush-covered or grass-covered land unless the exhaust system is equipped with a spark arrestor meeting any applicable local or state laws. Other states or federal areas may have similar laws.

A spark arrestor for your machine may be available from your authorized dealer. An installed spark arrestor must be maintained in good working order by the operator.

Parking Safely

1. Stop machine on a level surface, not on a slope.
2. Lower attachments to the ground.
3. Lock the park brake.
4. Stop the engine.
5. Remove the key.
6. Wait for engine and all moving parts to stop before you leave the operator's seat.
7. Close fuel shut-off valve, if your machine is equipped.

SAFETY

8. Disconnect the negative battery cable or remove the spark plug wire (for gasoline engines) before servicing the machine.

Checking Work Area

- Evaluate the terrain to determine what accessories and attachments are needed to properly and safely perform the job.
- Clear work area of objects that might interfere with operation. Keep people and pets out of work area.
- Low-hanging branches and similar obstacles can injure the operator or interfere with operation. Before operating, identify potential obstacles such as low-hanging branches, and trim or remove those obstacles.
- Study work area. Set up a safe driving pattern. Do not operate attachment where traction or stability is doubtful.

Protect Children and Prevent Accidents

Protect Children:

- Stay alert to the presence of children. Never assume that children will remain where you last saw them. Turn the machine off if a child enters the work area.
- Do not let children or an untrained person operate the machine. Instruct all operators not to give a ride on the machine or in an attachment.

Help Prevent Serious Or Fatal Accidents:

- Be alert at all times; drive forward carefully. People, especially children, can move quickly onto the worksite unnoticed.
- An operator must continuously be aware of all co-workers who share the worksite.
- Back up carefully. An operator must always look to each side and to the rear for bystanders before backing up.

Avoid Tipping

- Do not stop or start suddenly when going uphill or downhill. Be especially cautious when changing direction on slopes.
- When riding on soft terrain slopes, turn front wheel slightly uphill to keep machine on straight line across hill.
- If machine begins to tip, turn front wheel downhill to gain control before proceeding.
- If machine stops or loses power going uphill, apply

parking brake to hold vehicle on slope. Maintain direction of travel and release brake slowly to back straight downhill slowly while maintaining control. Do not turn vehicle sideways. Vehicle is more stable in a straight forward and rearward position.

- Stay alert for holes, rocks, and other hidden hazards in the terrain.
- Keep away from drop-offs, ditches, embankments, as well as ponds and other bodies of water. The machine could suddenly turn over if a wheel is over the edge of a cliff or ditch, or if an edge caves in.
- Keep front wheels straight at crest of hill or going over bumps.
- When descending a hill, remove foot from accelerator and apply brakes to reduce speed and maintain control.
- Adjust your speed to terrain conditions and visibility.

Keep Riders Off

- Only allow the operator on the machine. Keep riders off.
- Riders on the machine or attachment may be struck by foreign objects or thrown off the machine causing serious injury.
- Riders obstruct the operator's view resulting in the machine being operated in an unsafe manner.

Towing Loads Safely

- Stopping distance increases with speed and weight of towed load. Travel slowly and allow extra time and distance to stop.
- Total towed weight must not exceed combined weight of pulling machine, ballast and operator. Use counterweights or wheel weights as described in the attachment or pulling machine operator's manual.
- Excessive towed load can cause loss of traction and loss of control on slopes. Reduce towed weight when operating on slopes.
- Never allow children or others in or on towed equipment.
- Use only approved hitches. Tow only with a machine that has a hitch designed for towing. Do not attach towed equipment except at the approved hitch point.
- Follow the manufacturer's recommendations for weight limits for towed equipment and towing on slopes.
- If you cannot back up a slope with a towed load, the slope is too steep to operate on with the towed load. Reduce the towed load or do not operate.
- Do not turn sharply. Use additional caution when turning

SAFETY

or operating under adverse surface conditions. Use care when reversing.

- Do not shift to neutral and coast downhill.

Checking Wheel Hardware

- A serious accident could occur causing serious injury if wheel hardware is not tight.
- Check wheel hardware tightness often during the first 100 hours of operation.
- Wheel hardware must be tightened to specified torque using the proper procedure anytime it is loosened.

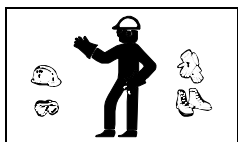

Wear Appropriate Clothing

- Always wear safety goggles, or safety glasses with side shields, and a hard hat when operating the machine.

- Wear close fitting clothing and safety equipment appropriate for the job.
- Wear a suitable protective device such as earplugs. Loud noise can cause impairment or loss of hearing.

Practice Safe Maintenance

- Only qualified, trained adults should service this machine.
- Understand service procedure before doing work. Keep area clean and dry.
- Never lubricate, service, or adjust machine while it is moving. Keep safety devices in place and in working condition.
- Keep hands, feet, clothing, jewelry, and long hair away from any moving parts, to prevent them from getting caught.
- Disconnect battery or remove spark plug wire before making any repairs.
- Before servicing machine or attachment, carefully release pressure from any components with stored energy, such as hydraulic components and springs.
- Release hydraulic pressure by lowering attachment or cutting units to the ground or to a mechanical stop and move hydraulic control levers back and forth.
- Keep all nuts and bolts tightened.
- Securely support any machine elements that must be raised for service work. Lock service latches before working on machine with raised attachments.

- Never run engine unless park brake is locked.
- Keep all parts in good condition and properly installed. Fix damage immediately. Replace worn or broken parts. Replace all worn or damaged safety and instruction decals.
- To prevent fires, remove any buildup of grease, oil, or debris from the machine, especially the engine.
- Charge batteries in an open, well-ventilated area, away from sparks. Unplug battery charger before connecting or disconnecting from the battery. Wear protective clothing and use insulated tools.
- Do not modify machine or safety devices. Unauthorized modifications may impair its function and safety.
- Do not wear radio or music headphones while servicing the machine. Safe service requires your full attention.
- Disconnect battery ground cable (-) on the machine or remove attachment from machine before welding on the machine.



Avoid High Pressure Fluids

- Hydraulic hoses and lines can fail due to physical damage, kinks, age, and exposure. Check hoses and lines regularly. Replace damaged hoses and lines.
- Hydraulic fluid connections can loosen due to physical damage and vibration. Check connections regularly. Tighten loose connections.
- Escaping fluid under pressure can penetrate the skin causing serious injury. Avoid the hazard by relieving pressure before disconnecting hydraulic or other lines. Tighten all connections before applying pressure.
- Search for leaks with a piece of cardboard. Protect hands and body from high pressure fluids.
- If an accident occurs, see a doctor immediately. Any fluid injected into the skin must be surgically removed within a few hours or gangrene may result. Doctors unfamiliar with this type of injury should reference a knowledgeable medical source. Such information is available from Deere & Company Medical Department in Moline, Illinois, U.S.A. Information may be obtained in the United States and Canada only by calling 1-800-822-8262.

Prevent Fires

- Remove grass and debris from engine compartment and muffler area, before and after operating machine.
- Always shut off fuel when storing or transporting machine, if the machine has a fuel shutoff.

SAFETY

- Do not store machine near an open flame or source of ignition, such as a water heater or furnace.
- Check fuel lines, tank, cap, and fittings frequently for cracks or leaks. Replace if necessary.



Tire Safety

Explosive separation of a tire and rim parts can cause serious injury or death:

- Do not attempt to mount a tire without the proper equipment and experience to perform the job.
- Always maintain the correct tire pressure. Do not inflate the tires above the recommended pressure. Never weld or heat a wheel and tire assembly. The heat can cause an increase in air pressure resulting in a tire explosion. Welding can structurally weaken or deform the wheel.
- When inflating tires, use a clip-on chuck and extension hose long enough to allow you to stand to one side and NOT in front of or over the tire assembly.
- Check tires for low pressure, cuts, bubbles, damaged rims or missing lug bolts and nuts.

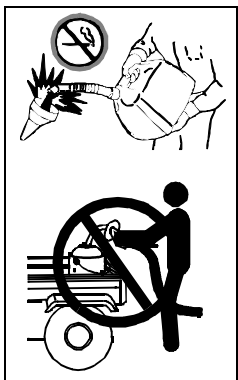

Handling Fuel Safely

To avoid personal injury or property damage, use extreme care in handling fuel. Fuel is extremely flammable and fuel vapors are explosive:

- Extinguish all cigarettes, cigars, pipes, and other sources of ignition.
- Use only an approved fuel container. Use only non-metal, portable fuel containers approved by the Underwriter's Laboratory (U.L.) or the American Society for Testing & Materials (ASTM). If using a funnel, make sure it is plastic and has no screen or filter.
- Never remove the fuel tank cap or add fuel with the engine running. Allow engine to cool before refueling.
- Never add fuel to or drain fuel from the machine indoors. Move machine outdoors and provide adequate ventilation.
- Clean up spilled fuel immediately. If fuel is spilled on clothing, change clothing immediately. If fuel is spilled near machine, do not attempt to start the engine but move the machine away from the area of spillage. Avoid creating any source of ignition until fuel vapors have dissipated.
- Never store the machine or fuel container where there is an open flame, spark, or pilot light such as on a water

heater or other appliance.

- Prevent fire and explosion caused by static electric discharge. Static electric discharge can ignite fuel vapors in an ungrounded fuel container.
- Never fill containers inside a vehicle or on a truck or trailer bed with a plastic liner. Always place containers on the ground away from your vehicle before fueling.
- Remove fuel-powered equipment from the truck or trailer and refuel it on the ground. If this is not possible, then refuel such equipment with a portable container, rather than from a fuel dispenser nozzle.
- Keep the nozzle in contact with the rim of the fuel tank or container opening at all times until the fueling is complete. Do not use a nozzle lock-open device.
- Never overfill fuel tank. Replace fuel tank cap and tighten securely.
- Replace all fuel container caps securely after use.
- For gasoline engines, do not use gas with methanol. Methanol is harmful to your health and to the environment.

Handling Waste Product and Chemicals

Waste products, such as, used oil, fuel, coolant, brake fluid, and batteries, can harm the environment and people:

- Do not use beverage containers for waste fluids - someone may drink from them.
- See your local Recycling Center or authorized dealer to learn how to recycle or get rid of waste products.
- A Material Safety Data Sheet (MSDS) provides specific details on chemical products: physical and health hazards, safety procedures, and emergency response techniques. The seller of the chemical products used with your machine is responsible for providing the MSDS for that product.

SAFETY LABELS

Understanding The Machine Safety Labels



Safety-Alert Symbol

The machine safety labels shown in this section are placed in important areas on your machine to draw attention to potential safety hazards.

On your machine safety labels, the words DANGER, WARNING, and CAUTION are used with this safety-alert symbol. DANGER identifies the most serious hazards.

The operator's manual also explains any potential safety hazards whenever necessary in special safety messages that are identified with the word, CAUTION, and the safety-alert symbol.

CAUTION Avoid Injury



M77041

- Read operator's manual.
- Know location and function of controls.
- Keep safety devices (guards, switches) in place and working.
- Never carry riders.
- Look behind before backing.
- Keep children and others away when operating machine.
- Stop engine before placing hands or feet near power

driven parts.

- When leaving machine:
- Stop engine • Set park brake • Remove key.

WARNING TCU26800

SPARK ARRESTOR



TCU26800

Operation of this equipment may create sparks that can start fires around dry vegetation. A spark arrestor may be required. the operator should contact local fire agencies for laws or regulations relating to fire prevention requirements.

Emission Control System Certification Label

NOTE: Tampering with emission controls and components by unauthorized personnel may result in severe fines or penalties. Emission controls and components can only be adjusted by EPA and/or CARB authorized service centers. Contact your John Deere Commercial and Consumer Equipment Retailer concerning emission controls and component questions.

The presence of an emissions label signifies that the engine has been certified with the United States Environmental Protection Agency (EPA) and/or California Air Resources Board (CARB).

The emissions warranty applies only to those engines marketed by John Deere that have been certified by the EPA and/or CARB; and used in the United States and Canada in off-road mobile equipment.

Emission Compliance Period

If your engine has the emission compliance category listed on the emission control system certification or air index label, this indicates the number of operating hours for which the engine has been certified to meet EPA and/or CARB emission requirements. The following table provides the engine compliance period in hours associated with the category found on the certification label.

SAFETY LABELS

Agency	Category	Hours
EPA	C	250
EPA	B	500
EPA	A	1000
CARB	Moderate	125
CARB	Intermediate	250
CARB	Extended	500

Canadian Electromagnetic Compatibility (EMC) Compliance

This spark ignition system complies with Canadian ICES-002.

Certification

Your product has been tested and evaluated by the manufacturer and conforms with American National Standard B-71.4, "Safety Specifications" for commercial turf care equipment.

OPERATING

Daily Operating Checklist

- Test safety systems.
- Check tire pressure.
- Check fuel level.
- Check engine oil level.
- Check hydraulic oil level.
- Remove grass and debris from machine.
- Clean air intake screen.
- Check area below machine for leaks.

Avoid Damage to Plastic and Painted Surfaces

- Do not wipe plastic parts unless rinsed first.
- Insect repellent spray may damage plastic and painted surfaces. Do not spray insect repellent near machine.
- Be careful not to spill fuel on machine. Fuel may damage surface. Wipe up spilled fuel immediately.

Operator Station Controls

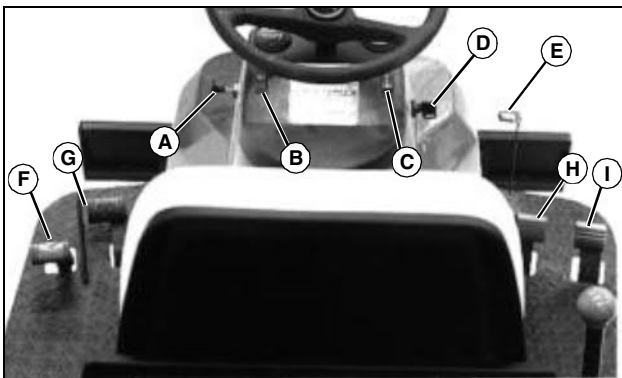

M77041

- A - Choke Lever**
- B - Light Switch**
- C - Power Rake Lift**
- D - Key**
- E - Park Brake Lever**
- F - Reverse Travel Pedal**
- G - Forward Travel Pedal**
- H - Brake Pedal**
- I - Accelerator Pedal**

Platform Controls

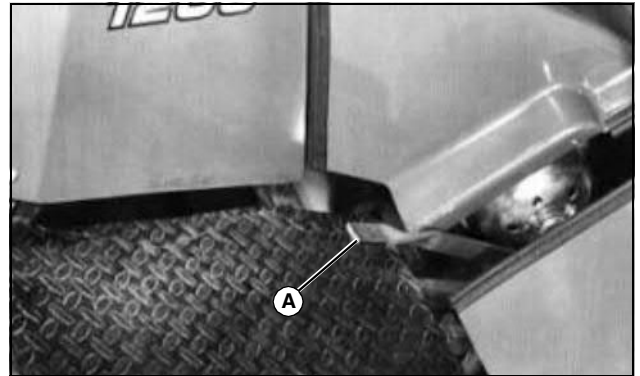

E32439



M77059

- A - Differential Lock Pedal**
- B - Cultivator Handle**
- C - Front Blade Handle**

Testing Safety Systems

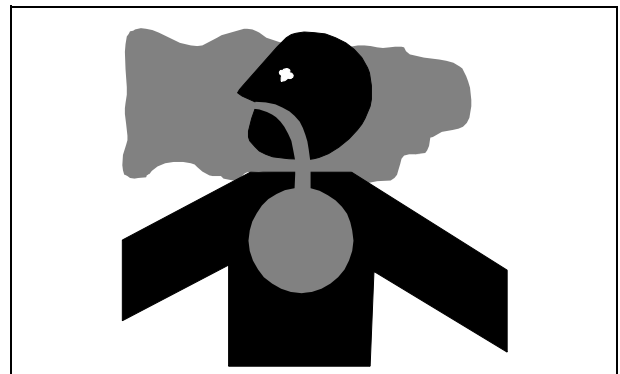

OPERATING



CAUTION: Avoid injury! Engine exhaust fumes contain carbon monoxide and can cause serious illness or death.

Move the machine to an outside area before running the engine.

Do not run an engine in an enclosed area without adequate ventilation.

- **Connect a pipe extension to the engine exhaust pipe to direct the exhaust fumes out of the area.**
- **Allow fresh outside air into the work area to clear the exhaust fumes out.**

The safety systems installed on your machine should be checked before each machine use. Be sure you have read the machine operator manual and are completely familiar with the operation of the machine before performing these safety system checks.

Use the following checkout procedures to check for normal operation of machine.

If there is a malfunction during one of these procedures, do not operate machine. **See your authorized dealer for service.**

Perform these tests in a clear open area. Keep bystanders away.

Testing Neutral Start System

1. Park machine safely. (See Parking Safely in the SAFETY Section.)
2. Sit on seat.
3. Engage the parking brake lock.
4. Move transmission pedals to forward or reverse position.
5. Turn key to the start position. Engine must not crank.

Using Park Brake Lock

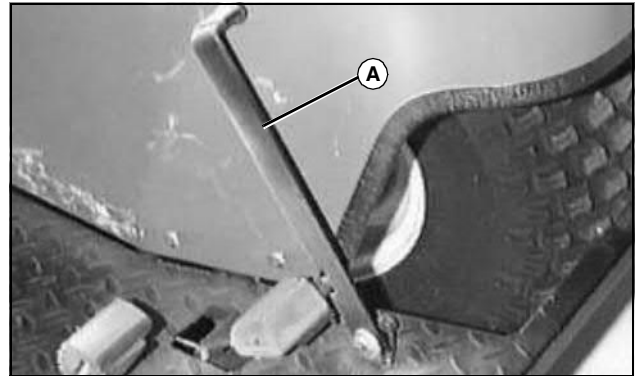

M77042

To lock park brake: Depress brake pedal completely and engage lever (A). Brake pedal should remain down when foot is removed.

To unlock park brake: Depress brake pedal and disengage lever. Brake pedal should release when foot is removed.

Using The Cultivator



M77059

1. Lift cultivator handle (A) up and pull in to lower cultivator. Place handle in one of five slots available for depth of cultivation desired.
2. To disengage cultivator from ground contact, pull handle in and up, and push out to lock in transport position.

OPERATING

Using The Rake

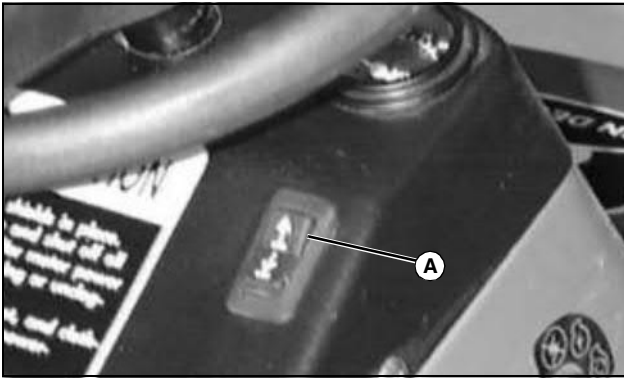

1. Push rake switch (A) arrow pointing up, to raise rake.
2. Push rake switch (A) arrow pointing down to lower the rake.

Using Front Blade

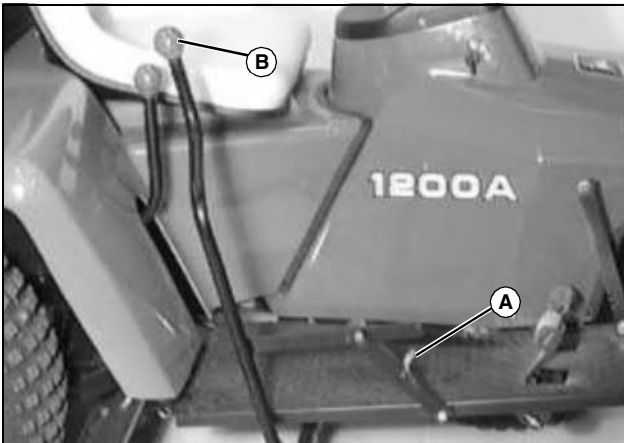

1. Remove locking pin (A) and place in front hole.

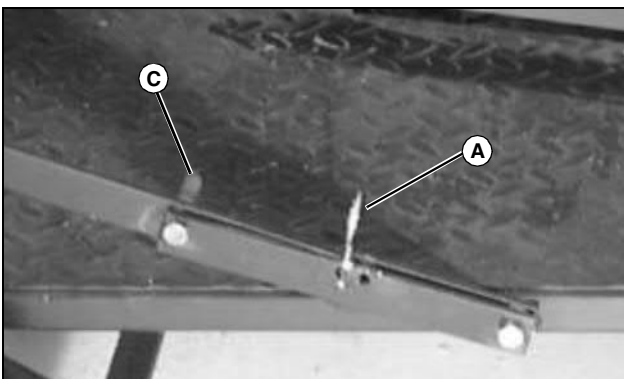

2. Lift red plastic cover (C) with right foot. Push front blade handle (B) forward to lower blade.

3. To lock blade in upward position, pull back handle (B) until locking pin (A) can be installed in rear hole.

Starting The Engine



CAUTION: Avoid injury! Engine exhaust fumes contain carbon monoxide and can cause serious illness or death.

Move the machine to an outside area before running the engine.

Do not run an engine in an enclosed area without adequate ventilation.

- **Connect a pipe extension to the engine exhaust pipe to direct the exhaust fumes out of the area.**

- **Allow fresh outside air into the work area to clear the exhaust fumes out.**

1. Park the machine safely. (See Parking Safely in the SAFETY section.)

2. Lock the park brake. Engine will not start if the park brake is not engaged.

3. Sit on operator's seat.

NOTE: This machine has a neutral start safety switch. Engine will not start unless transmission shift pedals are in neutral position.

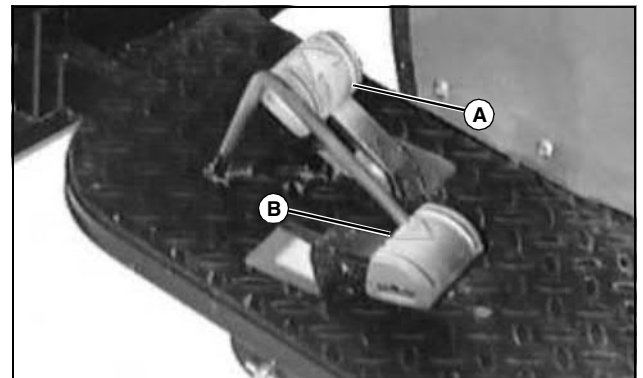

4. Move forward pedal (A) or reverse pedal (B) to (neutral)

5. Choke engine:

OPERATING

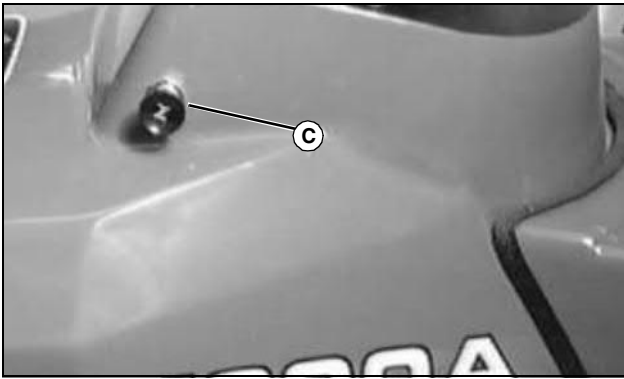

M77047

- Pull choke knob (C) halfway out if engine is warm.
- Pull choke knob all the way out if engine is cold.



CAUTION: Avoid injury! Never start engine while standing on ground. Start engine only from operator's seat, with transmission in neutral and park brake engaged.

IMPORTANT: Avoid damage! Starter may be damaged if starter is operated for more than 20 seconds at a time:

- Wait two minutes before trying again if engine does not start.

6. Turn key to start position, after engine starts, release key to run position.
7. Move throttle to half-speed position and gradually push in choke knob.
8. Disengage park brake.

Warming and Idling Engine

IMPORTANT: Avoid damage! Do not operate the engine at full throttle or under load until engine has warmed up, or engine damage could occur.

Warming Engine:

Run engine at half speed for 2 or 3 minutes.

Idling Engine:

Avoid unnecessary slow idling; instead, stop engine.

Stopping Engine

1. Move shift pedals to neutral position.

IMPORTANT: Avoid damage! Do not choke carburetor to stop engine. Backfire, fire or engine damage could occur.

2. Allow engine to run at 1/2 - 1/3 throttle and turn key to OFF position.
3. Remove key.
4. Engage park brake.

Using Gear Shift Pedals

IMPORTANT: Avoid damage! Do not shift gears when machine is slipping or with engine running above idle speed; damage to transmission will occur.

Always engage shift pedal with firm positive action.

The shift pedal is located on the floorboard to left side of seat. There are three positions:

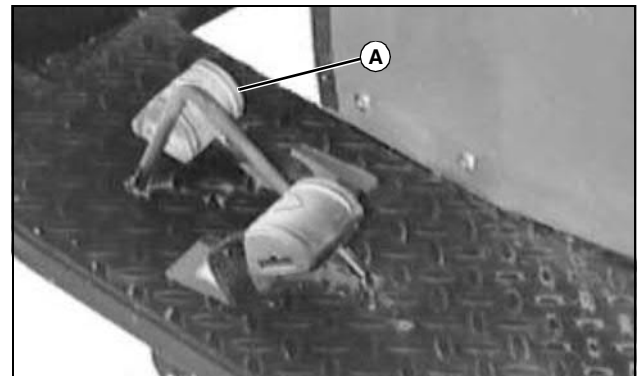

M72511

Forward: Push inside (forward arrow) pedal (A) down.

Neutral: Push forward or reverse pedal until both pedals are not engaged:

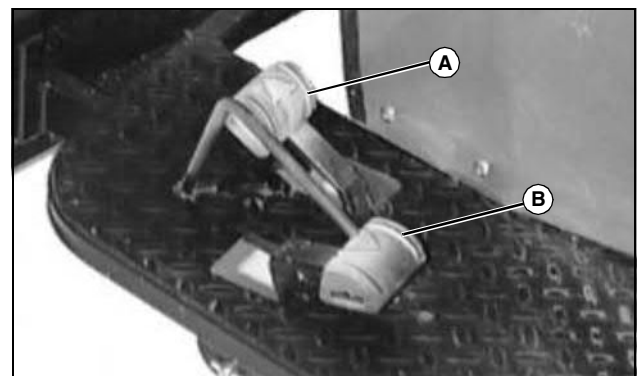

M72509

- If forward pedal (A) is engaged reverse pedal (B) must be pushed.

OPERATING

• If reverse pedal (B) is engaged, forward pedal (A) must be pushed.

Reverse: Push outside (reverse arrow) pedal (B) down.

Using Accelerator

CAUTION: Avoid injury! Reduce speed before braking or turning, when hauling loads, and while operating around obstacles or on hazardous off-road conditions.

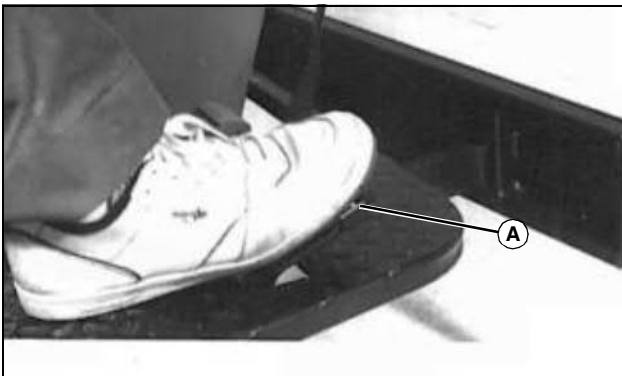

E32441

Push pedal (A) down slowly and smoothly.

Before braking, release accelerator pedal and allow engine to assist slowing down vehicle.

Using Brake Pedal

CAUTION: Avoid injury! Reduce speed before braking or turning, when hauling loads, and while operating around obstacles or on hazardous off-road conditions.

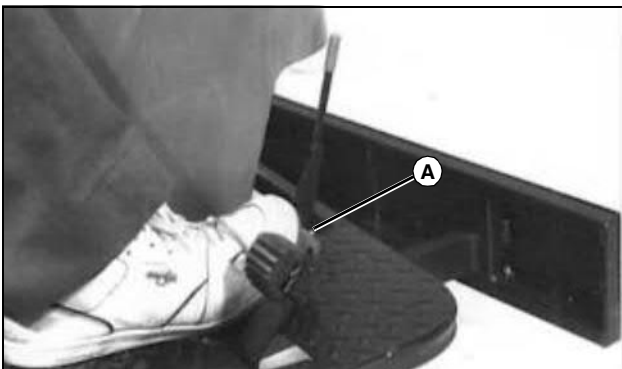

E32449

Release throttle pedal and apply brake (A) evenly and

firmly to slow down or stop. Avoid hard braking applications.

Using Differential Lock Pedal

CAUTION: Avoid injury! Due to loss of steering control. Do not operate machine at high speed or attempt to turn when differential lock is engaged.

IMPORTANT: Avoid damage! Do not attempt to engage or disengage differential lock while machine is slipping. Lock pins will not engage therefore damaging transaxle and/or linkage.

The differential lock is used to provide better traction when rear wheels start to slip. Engaging the differential lock will cause rear wheels to turn equally.

To engage differential lock (A):



E32452

NOTE: For differential lock to engage, the opposing wheel must be turning slightly faster than opposite wheel.

1. Stop or slow machine engine speed to 1/3 throttle or less.
2. Push down on pedal (A). Lock will remain engaged as long as pedal is depressed.

To disengage differential lock:

Remove foot from pedal. Machine must travel forward for differential to disengage.

OPERATING

Using Headlight Switch If Equipped

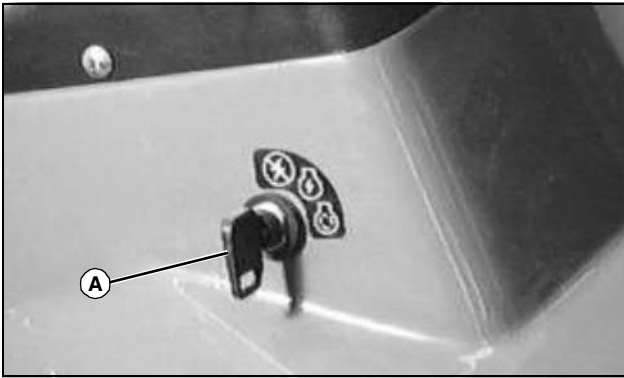

M77048

Turn key switch (A) to "RUN" position.

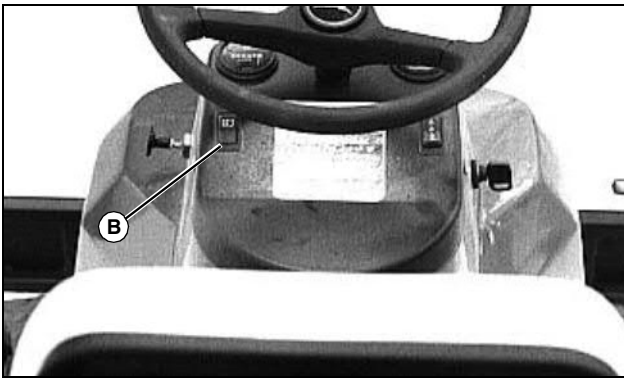

M77041

Push switch (B) to turn headlights on.

- Push switch (B) down to turn headlights off.

Transporting Machine



CAUTION: Avoid injury! Use extra care when loading or unloading the machine into a trailer or truck.

Close fuel shut-off valve, if your machine is equipped.

Do not tow machine behind any other vehicle. Use a heavy-duty trailer or truck to transport your machine. Trailer must have signs and lights required by law.

1. Drive machine forward onto a trailer. Lower any attachments to trailer deck.
2. Lock the park brake.
3. Lock the blade (if equipped) for transport.

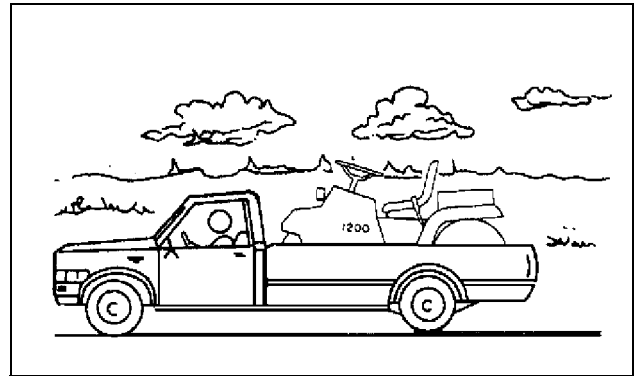

E32507

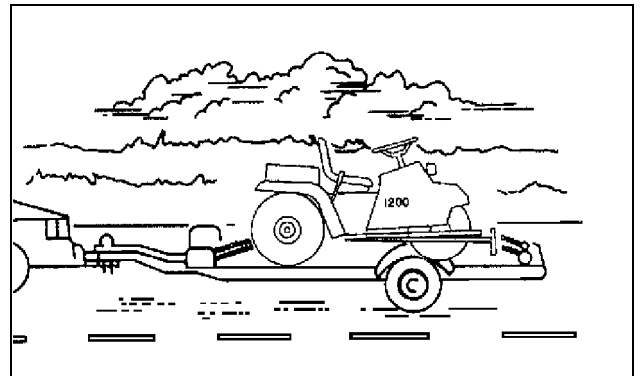

E32507A

4. Fasten machine to trailer with heavy-duty straps, chains, or cables using machine tie down areas (A). Both front and rear straps must be directed down and outward from machine.

Transport Loads Safely

Use care when pulling loads:

- Use only hitch point provided.
- Do not tow loads that exceed 500 pounds.
- Ten percent of towed weight should rest on drawbar.

REPLACEMENT PARTS

Service Literature

If you would like a copy of the Parts Catalog or Technical Manual for this machine call:

- **U.S. & Canada:** 1-800-522-7448.
- **All Other Regions:** Your John Deere dealer.

Parts

We recommend John Deere quality parts and lubricants, available at your John Deere dealer.

Part numbers may change, use part numbers listed below when you order. If a number changes, your dealer will have the latest number.

When you order parts, your John Deere dealer needs the serial number or product identification number (PIN) for your machine or attachment. These are the numbers that you recorded in the Product Identification section of this manual.

Order Service Parts Online

Visit <http://JDParts.deere.com> for your Internet connection to parts ordering and information.

Part Numbers

ITEM	PART NUMBER
Fuel Filter	AM116304
Battery	TY25220
Transmission Fluid	AM102723
Air Filter	M113621
Engine Oil Filter	AM107423
Spark Plug	M802138

(Part numbers are subject to change without notice. Part Numbers may be different outside the U.S.A.)



Suggest:

If the above button click is invalid.

Please download this document

first, and then click the above link

to download the complete manual.

Thank you so much for reading

SERVICE INTERVALS

Servicing Your Machine

IMPORTANT: Avoid damage! Operating in extreme conditions may require more frequent service intervals:

- Engine components may become dirty or plugged when operating in extreme heat, dust or other severe conditions.
- Engine oil may lose efficiency if vehicle is operated constantly at slow or low engine speeds or with frequent short trips.

Please use the following timetables to perform routine maintenance on your machine.

Break In - After First 10 Hours

- Check belt condition.
- Check and tighten drive wheel hardware to specification.
- Change engine oil and filter.

Break In - After First 20 Hours

- Tighten wheel lug nuts.

Before Each Use

- Check fuel and engine oil level.
- Clean engine cooling fin screen.

Every 50 Hours

- Inspect tires and check air pressure using low pressure gauge.
- Grease rear axle only.
- Check and adjust steering chain.
- Clean drive pulley.
- Check wear pads on driven clutch.
- Check belt condition.
- Clean battery and check battery fluid level.
- Clean rubber dust valve on air cleaner housing.

Every 100 Hours

- Change engine oil and filter.
- Check transaxle fluid.
- Check spark plug and adjust gap.
- Check and or clean engine breather.

Every 200 Hours

- Tighten wheel lug nuts.
- Replace and gap spark plug.

Yearly or as Required

- Replace internal air filter.
- Replace fuses, light bulbs, and battery.
- Clean engine cooling fins.
- Check condition of fuel lines.
- Change transaxle oil.

<https://www.ebooklibonline.com>

Hello dear friend!

Thank you very much for reading.

Enter the link into your browser.

The full manual is available for immediate download.

<https://www.ebooklibonline.com>