

JOHN DEERE
WORLDWIDE COMMERCIAL & CONSUMER
EQUIPMENT DIVISION

Professional Lawnmower
900

Pin (DM0900X940096-)

OMDMU210260K4

OPERATOR'S MANUAL



JOHN DEERE

European Version
Litho in the Netherlands

INTRODUCTION

Thank You for Purchasing a John Deere Product

We appreciate having you as a customer and wish you many years of safe and satisfied use of your machine.

Using Your Operator's Manual

This manual is an important part of your machine and should remain with the machine when you sell it.

Reading your operator's manual will help you and others avoid personal injury or damage to the machine. Information given in this manual will provide the operator with the safest and most effective use of the machine. Knowing how to operate this machine safely and correctly will allow you to train others who may operate this machine.

If you have an attachment, use the safety and operating information in the attachment operator's manual along with the machine operator's manual to operate the attachment safely and correctly.

This manual and safety signs on your machine may also be available in other languages (see your John Deere dealer to order).

Sections in your operator's manual are placed in a specific order to help you understand all the safety messages and learn the controls so you can operate this machine safely. You can also use this manual to answer any specific operating or servicing questions. A convenient index located at the end of this book will help you to find needed information quickly.

The machine shown in this manual may differ slightly from your machine, but will be similar enough to help you understand our instructions.

RIGHT-HAND and LEFT-HAND sides are determined by facing in the direction the machine will travel when going forward. When you see a broken line arrow (----->), the item referred to is hidden from view.

Before delivering this machine, your dealer performed a predelivery inspection to ensure best performance.

Machine Use

This machine is designed solely for use in customary lawn mowing operations, for park and amenity area maintenance and for winter work. Use in any other way is considered as contrary to the intended use.

The manufacturer accepts no liability for damage or injury resulting from this misuse, and these risks must be borne solely by the user. Compliance with and strict adherence to the conditions of operation, service and repair as specified

by the manufacturer also constitute essential elements for the intended use.

This machine should be operated, serviced and repaired only by persons familiar with all its particular characteristics and acquainted with the relevant safety rules (accident prevention). The accident prevention regulations, all other generally recognized regulations on safety and occupational medicine and the road traffic regulations must be observed at all times.

Setting fuel delivery beyond published factory specifications or otherwise overpowering will result in loss of warranty protection for this machine.

Any arbitrary modifications carried out on this machine will relieve the manufacturer of all liability for any resulting damage or injury.

Special Messages

Your manual contains special messages to bring attention to potential safety concerns, machine damage as well as helpful operating and servicing information. Please read all the information carefully to avoid injury and machine damage.



CAUTION: Avoid injury! This symbol and text highlight potential hazards or death to the operator or bystanders that may occur if the hazards or procedures are ignored

IMPORTANT: Avoid damage! This text is used to tell the operator of actions or conditions that might result in damage to the machine.

NOTE: General information is given throughout the manual that may help the operator in the operation or service of the machine.

PRODUCT IDENTIFICATION

Record Identification Numbers

900 Professional Lawnmower

Pin (DM0900X940096 -)

If you need to contact an Authorized Service Center for information on servicing, always provide the product model and serial number.

You will need to locate the model and serial number for the machine and for the engine of your machine and record the information in the spaces provided below.

DATE OF PURCHASE:

DEALER NAME:

DEALER PHONE:

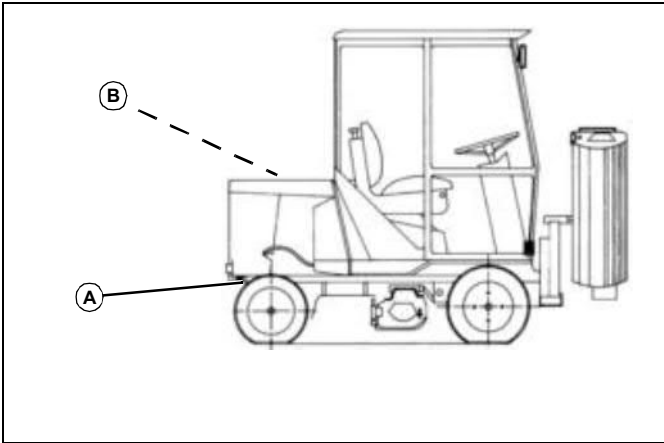

DM0794

PRODUCT IDENTIFICATION NUMBER (A):

ENGINE SERIAL NUMBER (B):

<https://www.ebooklibonline.com>

Hello dear friend!

Thank you very much for reading.

Enter the link into your browser.

The full manual is available for immediate download.

<https://www.ebooklibonline.com>

TABLE OF CONTENTS

Safety	1
Operating	9
Replacement Parts	21
Service Intervals	22
Service Lubrication	24
Service Engine	26
Service Transmission	34
Service Mower	37
Service Electrical	42
Service Miscellaneous	45
Troubleshooting	51
Storage	57
Assembly	59
Specifications	60
Declaration of Conformity	62
Index	63

All information, illustrations and specifications in this manual are based on the latest information at the time of publication. The right is reserved to make changes at any time without notice.

COPYRIGHT© 2005
Deere & Co.
John Deere Worldwide Commercial and
Consumer Equipment Division
All rights reserved
Previous Editions
COPYRIGHT©

OMDMU2102605 K4 - English

SAFETY

Pictorial Safety Signs

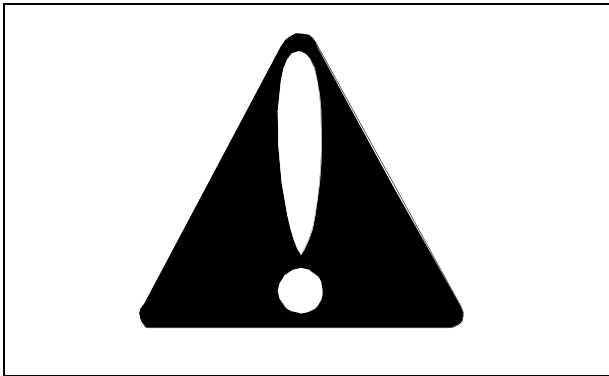

Safety Alert Symbol

At several important places on this machine safety signs are affixed intended to signify potential danger. The hazard is identified by a pictorial in a warning triangle. An adjacent pictorial provides information how to avoid personal injury. These safety signs, their placement on the machine and a brief explanatory text are shown in this Safety section.

Avoid Injury From Rotating Blades

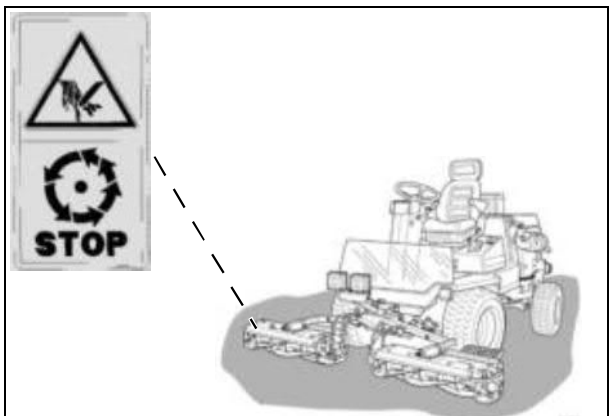

Z59868 / 0900

Do not put hands or feet under or into cutting units when engine is running.

Avoid Injury From Cutting Units

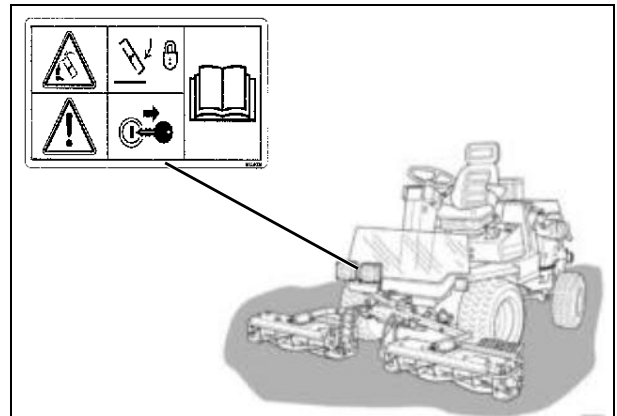

M139475 / 0900

Read Operator's Manual. Lift arms raise at high speed and can cause serious injury when removing cutting units

Avoid Injury From Lift Arms

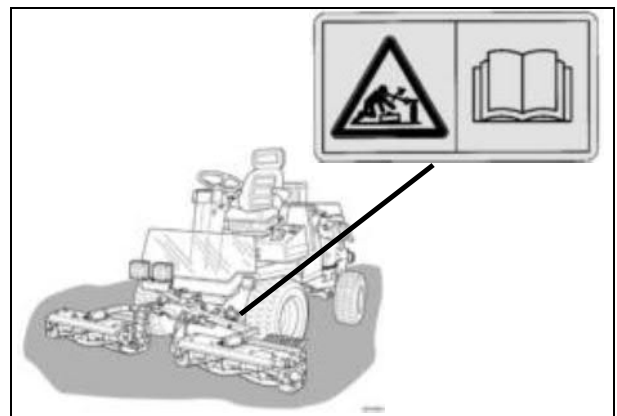

0900 / DM0971

Lift arms raise at high speed and can cause serious injury when removing cutting units

SAFETY

Read Operators Manual



DM0797 / DM0758

This operator's manual contains important information necessary for safe machine operation. Observe all safety rules to avoid accidents.

Avoid Injury from Fan

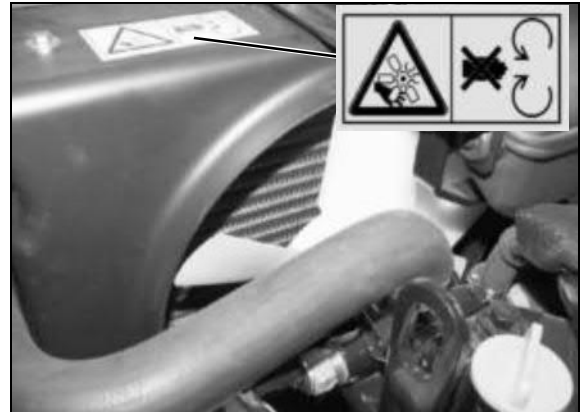

DM0968 / DM0809

Do not open or remove safety shields while engine is running.

Avoid Injury from Radiator, Coolant Gases and Fluids



DM0795 / DM0813

Read manual before opening cap.

Avoid Injury From Tipping



DM0823 / DM0757

Do not use mower on inclines with an angle exceeding 30%.

SAFETY

CE Certification, Specification and Sound Labels

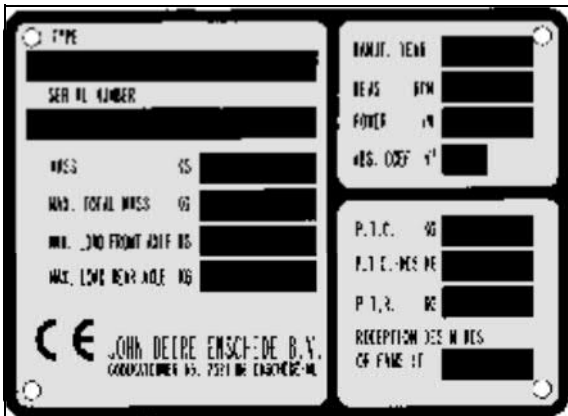

DMU210130

This serial number plate on your machine indicates that this model has been certified and complies with the applicable requirements of Machine Directive 98/37/EEC (89/392EEC) Standards.

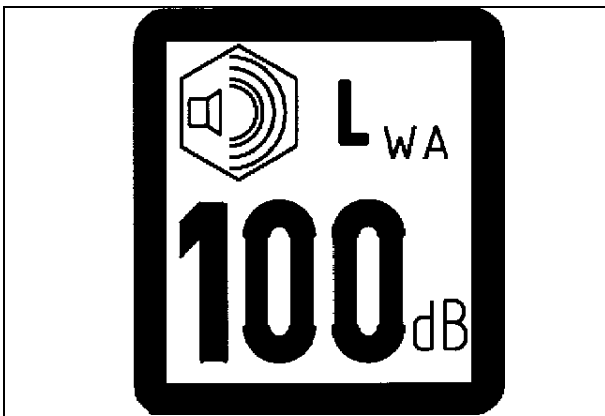

DM0737

This label on your machine indicates that this model complies with the applicable requirements of noise machine directive 2000/14/EC

Operator Training Required

- The owner of the machine is responsible for training the users and mechanics of the machine.
- The owner/user can prevent and is responsible for accidents or injuries occurring to themselves, other people, or property.
- Do not allow operation or service of the machine by children or untrained adults.
- Read the operator's manual and study the safety and operation sections before operating the machine.
- If the operator of the machine cannot read or

understand this manual, it is the machine's owner responsibility to explain this material to the operator. This publication is available in other languages.

- Operate the machine in an open, unobstructed area under the direction of an experienced operator.
- Learn the use of all controls.
- Operator experience is required to learn the moving, stopping, turning and other operating characteristics of the machine.

Operating Safely

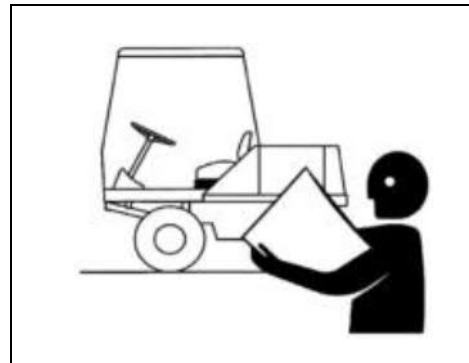

DM0113

- Inspect machine before you operate. Be sure hardware is tight. Repair or replace damaged, badly worn, or missing parts. Be sure guards and shields are in good condition and fastened in place. Make any necessary adjustments before you operate.
- Check before each use that operator presence controls are functioning correctly. Test safety systems. Do not operate unless they are functioning correctly.
- Do not change the engine governor setting or overspeed the engine.
- Check brake action before you operate. Adjust or service brakes as necessary.
- Stop machine if anyone enters the area.
- If you hit an object, stop and inspect the machine. Make repairs before you operate. Keep machine and attachments properly maintained and in good working order.
- Do not leave machine unattended when it is running.
- Only operate during daylight or with good artificial light.
- Slow down and be careful of traffic when operating near or crossing roadways. Stop blades before crossing roads or sidewalks. Use care when approaching blind corners, shrubs, trees, or other objects that may obscure vision.
- Be careful of traffic when operating near roadways. Use

SAFETY

care when approaching blind corners, shrubs, trees, or other objects that may obscure vision.

- Be aware of the mower discharge direction and make sure that no one is in the path of the discharge direction.
- Use only accessories and attachments approved by the manufacturer of the machine.

Checking Mowing Area

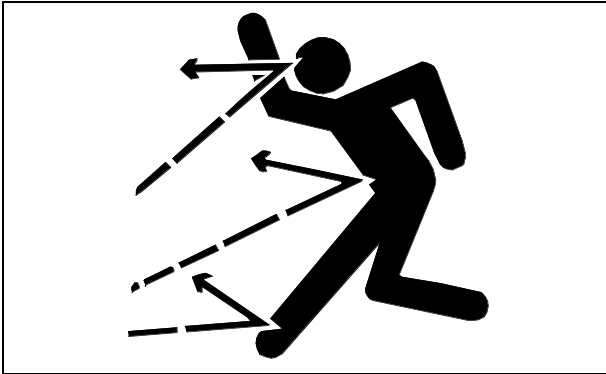

- Evaluate the terrain to determine what accessories and attachments are needed to properly and safely perform the job. Only use accessories and attachments used by the manufacturer.
- Clear mowing area of objects that might be thrown. Keep people and pets out of mowing area.
- Study mowing area. Set up a safe mowing pattern. Do not mow where traction or stability is doubtful.
- Test drive area with mower lowered but not running. Slow down when you travel over rough ground.

Parking Safely

1. Stop machine on a level surface, not on a slope.
2. Stop mower blades or attachments.
3. Lower attachments to the ground.
4. Lock park brake.
5. Stop engine.
6. Remove key.
7. Wait for engine and all moving parts to stop before you leave the operator's station.

Avoid Tipping

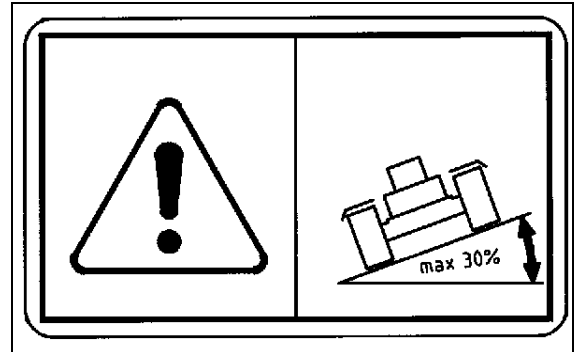

DM0757

- Slopes are a major factor related to loss-of-control and tip-over accidents, which can result in severe injury or death.
- Do not drive where machine could slip or tip.
- Stay alert for holes and other hidden hazards in the terrain.
- Keep away from drop-offs, ditches, and embankments.
- Slow down before you make a sharp turn or operate on a slope.
- Transport machine with attachments lowered to improve stability.
- Drive machine very slowly and avoid quick stops when attachment is removed.
- Drive up and down a hill - not across. If necessary, turn slowly and in the downhill direction.
- Do not stop when going up hill or down hill. If machine stops going up hill, disengage mower blades and back down slowly.
- Mowing when grass is wet can cause reduced traction and sliding.

SAFETY

Keep Riders Off



DM0112

- Only allow the operator on the machine. Keep riders off.
- Riders on the machine or attachment may be struck by foreign objects or thrown off the machine causing serious injury.
- Riders obstruct the operator's view resulting in the machine being operated in an unsafe manner.

Protect Children

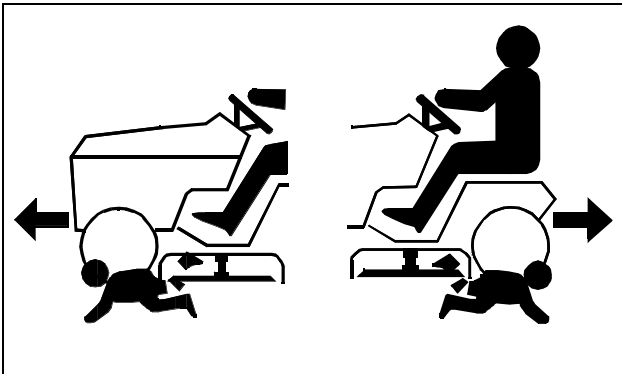

- Death or serious injury can occur when young children associate having fun with a lawn mowing machine simply because someone has given them a ride on a machine.
- Young children are attracted to lawn mowing machines and mowing activities. They don't understand the dangers of rotating blades or the fact that the operator is unaware of their presence.
- Tragic accidents with children can occur if the operator is not alert to the presence of children, especially when a child approaches a machine from behind. Before backing up, stop mower blades and look down and behind the machine carefully, especially for children.
- Never carry children on a machine or attachment, even with the blades off. Do not tow children in a cart or trailer. They can fall off and be seriously injured or interfere with

safe machine operation.

- Never use the machine as a recreational vehicle or to entertain children.
- Do not let children or an untrained person operate the machine. Instruct all operators not to give children a ride on the machine or in an attachment.
- Keep children indoors, out of the mowing area, and under the watchful eye of a responsible adult when a mower is being operated.
- Stay alert to the presence of children. Never assume that children will remain where you last saw them. Turn the machine off if a child enters the work area.

Checking Wheel Bolts

- A serious accident could occur causing serious injury if wheel bolts are not tight.
- Check wheel bolt tightness often during first 100 hours of operation.
- Wheel hardware must be tightened to specified torque using the proper procedure anytime it is loosened

Wear Appropriate Clothing

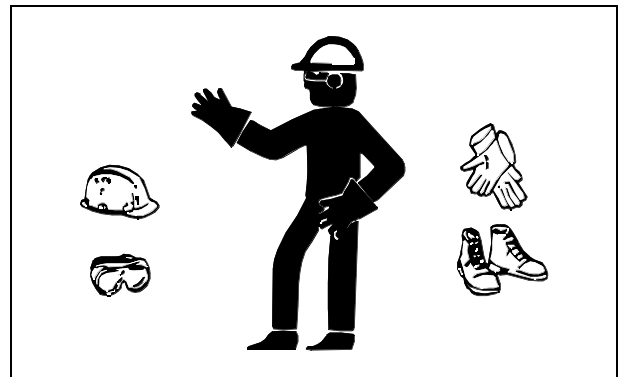

- Wear close fitting clothing and safety equipment appropriate for the job.
- Always wear safety goggles or safety glasses with side shields when operating the mower.
- Wear a suitable protective device such as earplugs. Loud noise can cause impairment or loss of hearing.
- Do not wear radio or music headphones. Safe service and operation requires your full attention.

SAFETY

Practice Safe Maintenance



- Only qualified, trained adults should service this machine.
- Understand service procedure before doing work. Keep area clean and dry.
- Never lubricate, service, or adjust machine while it is moving. Keep safety devices in place and in working condition. Keep hardware tight.
- Keep hands, feet, clothing, jewelry, and long hair away from any moving parts, to prevent them from getting caught.
- Lower attachments to the ground before servicing machine. Disengage all power and stop the engine. Lock park brake and remove the key. Let machine cool.
- Disconnect battery or remove spark plug wire before making any repairs.
- Before servicing machine, carefully release pressure from components with stored energy such as hydraulic components.
- Keep all nuts and bolts tightened, especially blade attachment bolts.
- Securely support any machine elements that must be raised for service work. Lock service latches before working on machine with raised attachments.
- Never run engine unless park brake is locked.
- Keep all parts in good condition and properly installed. Fix damage immediately. Replace worn or broken parts. Replace all worn or damaged safety and instruction decals.
- To prevent fires, remove any buildup of grease, oil, or debris from the machine, especially the engine compartment.
- Charge batteries in an open, well-ventilated area, away from sparks. Unplug battery charger before connecting or disconnecting from the battery. Wear protective clothing and use insulated tools.
- Do not modify machine or safety devices. Unauthorized

modifications may impair its function and safety.

- Do not wear radio or music headphones while servicing the machine. Safe service requires your full attention.

Avoid High Pressure Fluids



- Hydraulic hoses and lines can fail due to physical damage, kinks, age, and exposure. Check hoses and lines regularly. Replace damaged hoses and lines.
- Hydraulic fluid connections can loosen due to physical damage and vibration. Check connections regularly. Tighten loose connections.
- Escaping fluid under pressure can penetrate the skin causing serious injury. Avoid the hazard by relieving pressure before disconnecting hydraulic or other lines. Tighten all connections before applying pressure.
- Search for leaks with a piece of cardboard. Protect hands and body from high pressure fluids.
- If an accident occurs, see a doctor immediately. Any fluid injected into the skin must be surgically removed within a few hours or gangrene may result. Doctors unfamiliar with this type of injury should reference a knowledgeable medical source.

SAFETY

Prevent Fires

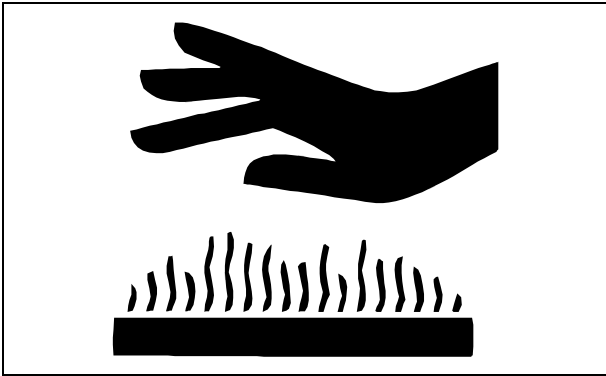

- Never remove fuel cap, or add fuel with engine running or hot. Allow engine to cool for several minutes.
- Never store equipment with fuel in the tank inside a building where fumes may reach an open flame or spark.
- Allow engine to cool before storing in any enclosure.
- To reduce fire hazard, keep engine free of grass, leaves, or excessive grease.

Tire Safety

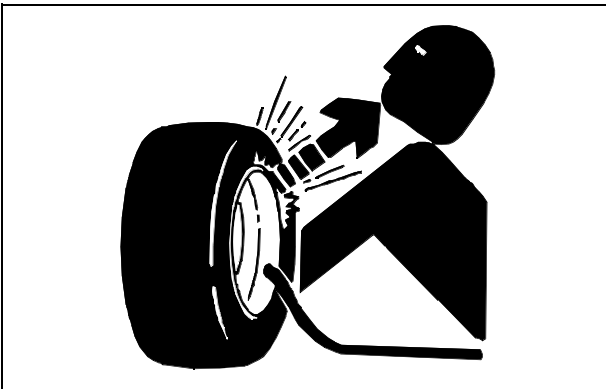

- Do not attempt to mount a tire without the proper equipment and experience to perform the job.
- Always maintain the correct tire pressure. Do not inflate the tires above the recommended pressure. Never weld or heat a wheel and tire assembly. The heat can cause an increase in air pressure resulting in a tire explosion. Welding can structurally weaken or deform the wheel.
- When inflating tires, use a clip-on chuck and extension hose long enough to allow you to stand to one side and not in front of or over the tire assembly.
- Check tires for low pressure, cuts, bubbles, damaged rims or missing lug bolts and nuts.

Handling Fuel Safely

Fuel and fuel vapors are highly flammable and explosive:

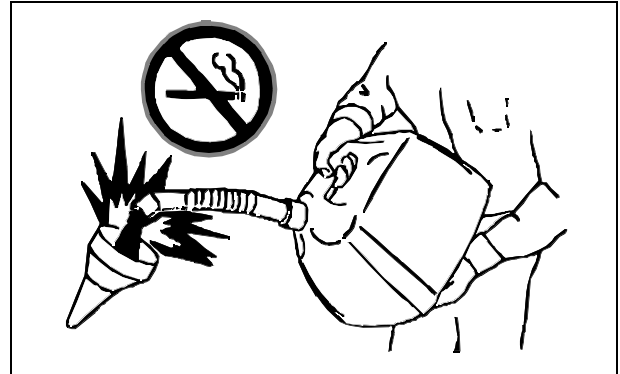

- Do not refuel machine while you smoke, when machine is near an open flame or sparks, or when engine is running. Stop engine and allow to cool before filling.
- Never remove the fuel cap or add fuel with the engine running.
- Never fill fuel tank or drain fuel from a machine in an enclosed area. Fill fuel tank outdoors.
- Prevent fires. Clean up spilled fuel immediately.
- Do not store machine with fuel in tank in a building where fumes may reach an open flame or spark.
- Prevent fire and explosion caused by static electric discharge. Use only non-metal, portable fuel containers. If using a funnel, make sure it is plastic and has no screen or filter.



- When practical, remove equipment from trailers or truck beds and refuel them on the ground. If this is not possible, use a portable, plastic fuel container to refuel equipment on a truck bed or trailer.

SAFETY

Handling Waste Product and Chemicals

Waste products, such as used oil, fuel, coolant, brake fluid, and batteries can harm the environment and people.

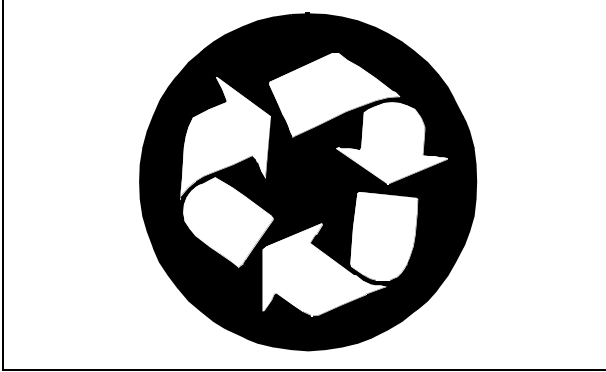

- DO NOT use beverage containers for waste fluids - someone may drink from them.
- See your local Recycling Center or John Deere dealer to learn how to recycle or get rid of waste products.

OPERATING

Daily Checklist

- Check tire pressure
- Check hydraulic oil level
- Check engine oil level
- Check coolant
- Test safety systems
- Remove grass and debris from machine
- Clean air intake screens for engine and oil cooler
- Check area below machine for leaks
- Clean radiator fins
- Check latches of cutting units
- Check fuel level
- Check V- belt of the air fan
- Check leakage (oil, fuel, coolant)
- Clean air filter

- F - All Wheel Drive Switch
- G - Hazard Light Switch (optional)
- H - Hour Meter

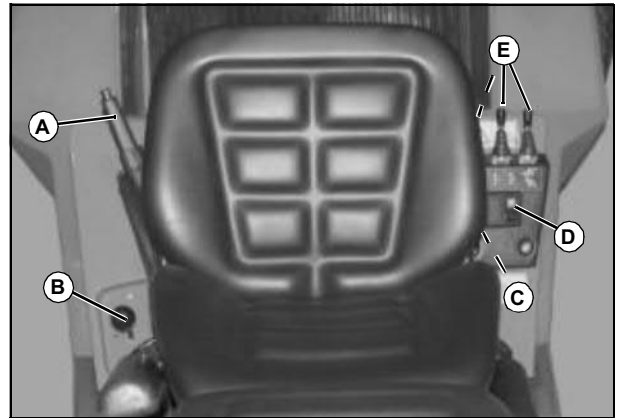

DM0797

- A - Park Brake
- B - Throttle Lever
- C - Mowing / Backlapping Switch
- D - Lifting / Lowering Switch
- E - Joysticks Lifting / Lowering

Avoid Damage to Plastic and Painted Surfaces

- Insect repellent spray may damage plastic and painted surfaces. Do not spray insect repellent near machine.
- Be careful not to spill fuel on machine. Fuel may damage surface. Wipe up spilled fuel immediately.

Operator Controls

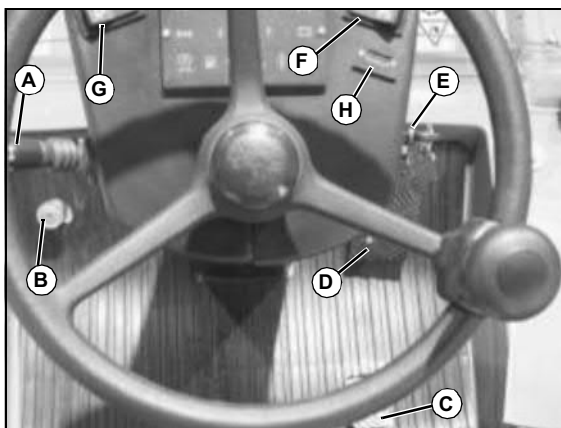

DM0796

- A - Steering Column Switch (optional)
- B - Foot Switch
- C - Rear Driving Pedal
- D - Front Driving Pedal
- E - Ignition Key

Indicator Panel

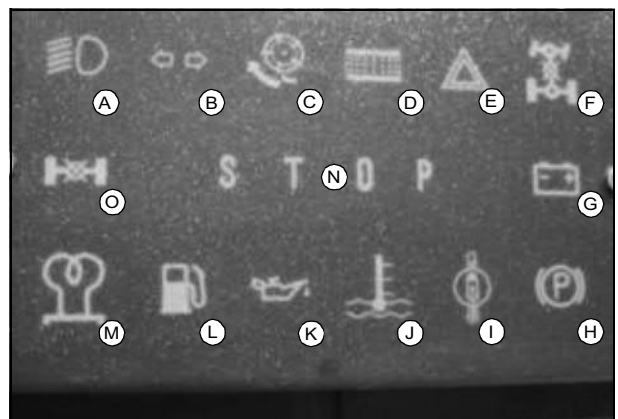

DM0798

- A - Head light
- B - Blinker
- C - Not in use
- D - Air-Filter Condition
- E - Hazard Signal
- F - All Wheel Drive (optional)
- G - Charge Control
- H - Not in use
- I - Hydraulic Oil Temperature Lamp
- J - Coolant Temperature Lamp
- K - Low Oil Pressure Lamp
- L - Not in use
- M - Not in use

OPERATING

- M - Glow Indicator
- N - Hazard Signal/Stop
- O - Differential lock (optional)

Adjusting Seat

CAUTION: Avoid injury! Adjust seat before moving or operating machine.

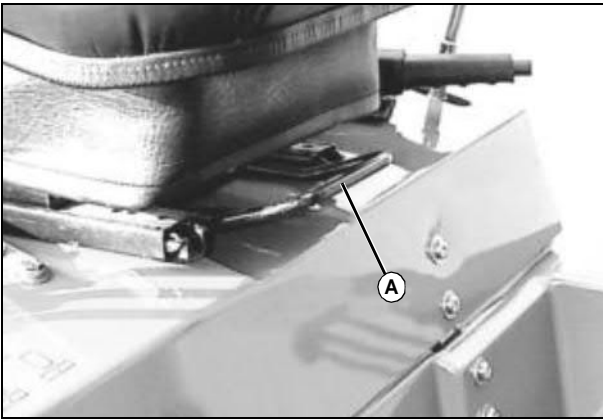

DM0799

Forward And Backwards

1. Pull up lever (A).
2. Move seat to desired position.
3. Release lever.

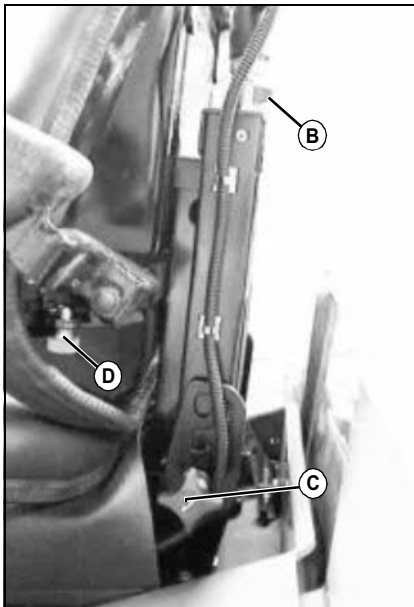

DM0800

Weight Adjustment (A)

- Turn knob (B) clockwise for stiffer suspension.
- Turn knob counterclockwise for looser suspension.

Height of Seat

- Turn knob (C) clockwise to raise seat.
- Turn knob counterclockwise to lower seat.

Arm rest height adjustment

- Turn knob (D) clockwise to lower armrest.
- Turn knob to raise armrest.

Adjusting Optional Luxury Seat

CAUTION: Avoid injury! Adjust seat before moving or operating machine.

Weight Adjustment

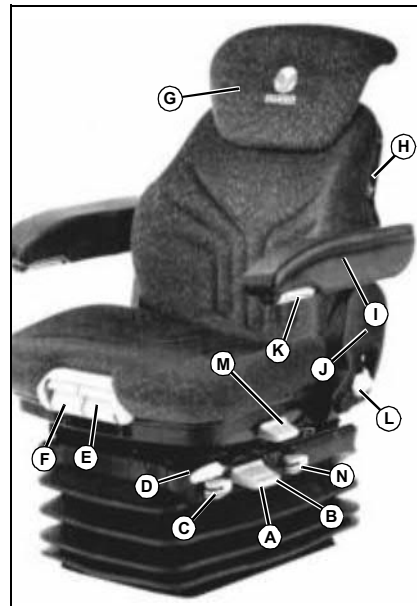

DM0014

1. Pull lever (A).
2. Adjust weight.
3. Release lever.

Height Adjustment (B)

IMPORTANT: Avoid damage! Do not operate compressor for more than 1 minute.

1. Pull or press lever (B) fully in or out.
2. Adjust height.



Suggest:

If the above button click is invalid.

Please download this document

first, and then click the above link

to download the complete manual.

Thank you so much for reading

OPERATING

3. Release lever.

Fore/Aft Isolator (C)

- Set knob to the front to lock fore/aft isolator.
- Set knob to the back to unlock fore/aft isolator.

Fore/Aft Adjustment (D)

1. Lift lever (D).
2. Latch into desired position.
3. Lower lever.

Seat Pan Angle Adjustment (E)

1. Lift lever (E).
2. Move to desired position by exerting pressure on or off seat pan.
3. Lower lever.

Seat Depth Adjustment (F)

1. Lift lever (F).
2. Move to desired seating position.
3. Lower lever.

Backrest Extension (G)

- Pull or push backrest up or down.

Lumbar Support (H)

- Turn knob for desired height and curvature. The curve can be individually adjusted by pressing upper and lower switches.

Armrest (I) Height Adjustment:

1. Separate round cap (J) from cover.
2. Loosen round nut (13mm).
3. Adjust armrest to desired position.
4. Tighten nut.

Armrest Adjustments (K)

Turn knob for inclination.

Backrest Adjustment (L)

Let lock lever latch in desired position

Swivel (M)

1. Pull lever (M).
2. Rotate seat into desired position.
3. Lower lever.

Absorber (N)

1. Set knob to the front for looser suspension.
2. Set knob to the back for stiffer suspension.

Using Seat Belt



CAUTION: Avoid injury! When operating a machine with a cabin or a foldable Rops in upright position, always wear the provided seat belt. If the machine has an open operator station or ROPS must be folded down, do NOT use the seat belt. Raise the foldable ROPS and use the seat belt as soon as the conditions permit.

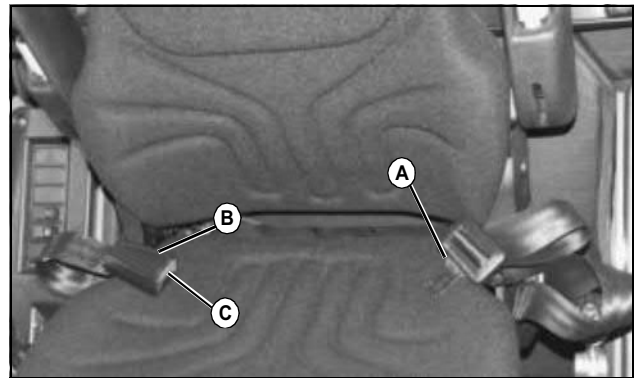

DM1089

1. Sit in seat.
2. Pull out seat belt buckle (A) and stretch across your lap.
3. Insert seat belt buckle into latch (B) until it locks.
4. To release seat belt, press red button (C) until buckle comes out of latch.

Using Throttle Lever

NOTE: Always operate at full throttle for best mowing performance.

<https://www.ebooklibonline.com>

Hello dear friend!

Thank you very much for reading.

Enter the link into your browser.

The full manual is available for immediate download.

<https://www.ebooklibonline.com>