

JOHN DEERE
WORLDWIDE COMMERCIAL & CONSUMER
EQUIPMENT DIVISION

**Mini-Frame Z-Trak™
717A and 727A**

OMTCU19790 B5

OPERATOR'S MANUAL

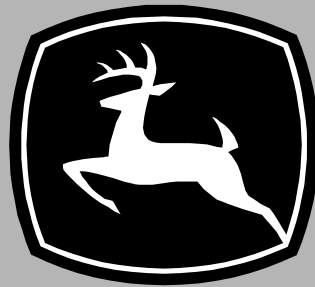

JOHN DEERE

⚠ WARNING: The Engine Exhaust
from this product contains chemicals known
to the State of California to cause cancer,
birth defects or other reproductive harm.

California Proposition 65 Warning

North American Version
Litho in U.S.A.



DCY



OMTCU19790

INTRODUCTION

Thank You for Purchasing a John Deere Product

We appreciate having you as a customer and wish you many years of safe and satisfied use of your machine.

Using Your Operator's Manual

This manual is an important part of your machine and should remain with the machine when you sell it.

Reading your operator's manual will help you and others avoid personal injury or damage to the machine. Information given in this manual will provide the operator with the safest and most effective use of the machine. Knowing how to operate this machine safely and correctly will allow you to train others who may operate this machine.

If you have an attachment, use the safety and operating information in the attachment operator's manual along with the machine operator's manual to operate the attachment safely and correctly.

This manual and safety signs on your machine may also be available in other languages (see your authorized dealer to order).

Sections in your operator's manual are placed in a specific order to help you understand all the safety messages and learn the controls so you can operate this machine safely. You can also use this manual to answer any specific operating or servicing questions. A convenient index located at the end of this book will help you to find needed information quickly.

The machine shown in this manual may differ slightly from your machine, but will be similar enough to help you understand our instructions.

RIGHT-HAND and LEFT-HAND sides are determined by facing in the direction the machine will travel when going forward. When you see a broken line (-----), the item referred to is hidden from view.

Before delivering this machine, your dealer performed a predelivery inspection to ensure best performance.

Special Messages

Your manual contains special messages to bring attention to potential safety concerns, machine damage as well as helpful operating and servicing information. Please read all the information carefully to avoid injury and machine damage.



CAUTION: Avoid injury! This symbol and text highlight potential hazards or death to the operator or bystanders that may occur if the hazards or procedures are ignored.

IMPORTANT: Avoid damage! This text is used to tell the operator of actions or conditions that might result in damage to the machine.

NOTE: General information is given throughout the manual that may help the operator in the operation or service of the machine.

Attachments for Your Machine

There's a John Deere attachment or kit to make your new machine perform more tasks or be more versatile, whether your machine is a lawn tractor or compact utility tractor or a utility vehicle.

You can check out the entire line of attachments for your machine at JohnDeere.com or ask your John Deere dealer. From aerators to electric lift kits to tillers, there's a John Deere attachment or kit to fill every need.

PRODUCT IDENTIFICATION

Record Identification Numbers

Mini-Mount Z-Trak™ 717A and 727A

PIN (020001 -)

If you need to contact an Authorized Service Center for information on servicing, always provide the product model and serial number.

You will need to locate the model and serial number for the machine and for the engine of your machine and record the information in the spaces provided below.

DATE OF PURCHASE:

DEALER NAME:

DEALER PHONE:

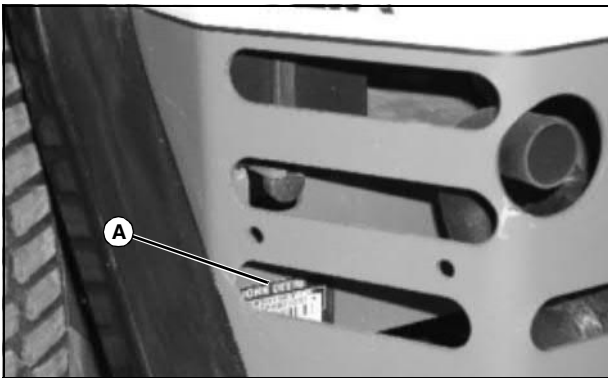

MX21469

PRODUCT IDENTIFICATION NUMBER (A):

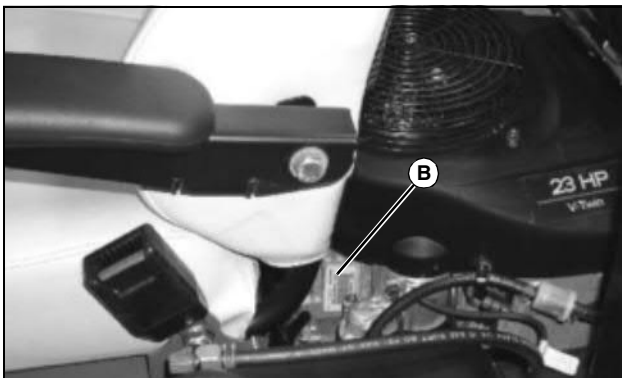

MX21470

ENGINE SERIAL NUMBER (B):

<https://www.ebooklibonline.com>

Hello dear friend!

Thank you very much for reading.

Enter the link into your browser.

The full manual is available for immediate download.

<https://www.ebooklibonline.com>

TABLE OF CONTENTS

Safety Labels	1
Safety	4
Operating	11
Replacement Parts	27
Service Intervals	28
Service Lubrication	29
Service Engine	31
Service Transmission	37
Service Steering & Brakes.....	42
Service Mower	45
Service Electrical.....	49
Service Miscellaneous.....	51
Troubleshooting	54
Storage	58
Specifications	60
Warranty	63
Index.....	66

All information, illustrations and specifications in this manual are based on the latest information at the time of publication. The right is reserved to make changes at any time without notice.

COPYRIGHT© 2005

Deere & Co.

John Deere Worldwide Commercial and Consumer Equipment Division

All rights reserved

Previous Editions

COPYRIGHT©

OMTCU19790 B5 - English

SAFETY LABELS

Understanding The Machine Safety Labels

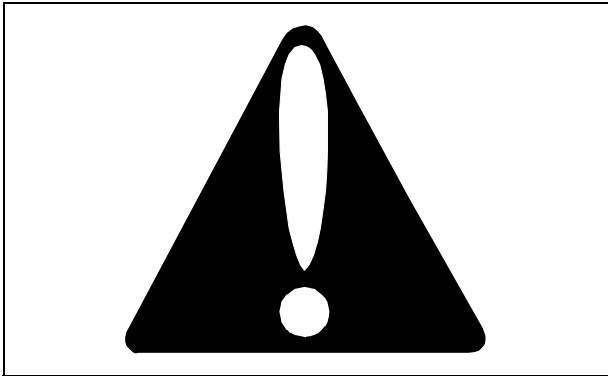

Safety-Alert Symbol

The machine safety labels shown in this section are placed in important areas on your machine to draw attention to potential safety hazards.

On your machine safety labels, the words DANGER, WARNING, and CAUTION are used with this safety-alert symbol. DANGER identifies the most serious hazards.

The operator's manual also explains any potential safety hazards whenever necessary in special safety messages that are identified with the word, CAUTION, and the safety-alert symbol.

Safety Label Locations



MX21487a, M131739, TCU51051, TCU13514

WARNING (A)

To avoid injury from rotating belts, keep all shields and guards in place.

WARNING (B)

AVOID CRUSHING

- Keep Rollover Protective Structure fully extended
- Do not jump if machine tips
- Use seat belt

When structure must be down

- DO NOT use seat belt
- Drive with extra care

DANGER (C)

To avoid injury from rotating blades, stay clear of deck edge.

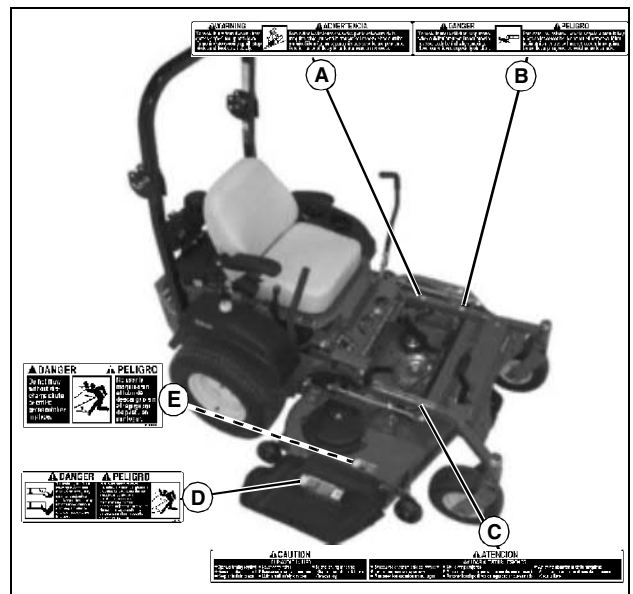

MX21478a, M131748, M137637, TCU16828, TCU20385

WARNING (A)

- To avoid injury from tipover, drive across slopes, not up and down. If machine stops going uphill, stop blades and back down slowly.

DANGER (B)

- To avoid injury to children, stop mower when children are near. Do not mow in reverse. Look behind when backing. Never carry riders, especially children.

CAUTION: HELP AVOID INJURY (C)

- Operator training required
- Read operator's manual
- Never carry riders
- Keep people a safe distance away
- Do not operate the machine without guards, shields and safety devices in place and working

SAFETY LABELS

- Before leaving machine:
 - Stop engine
 - Set park brake
 - Remove key

DANGER (D)

To avoid injury from rotating blades and thrown objects, stay clear of deck edge and keep others away. Do not mow without discharge chute or entire grass catcher in place.

DANGER (E)

Do not mow without discharge chute or entire grass catcher in place.



MX21479a, M134406, MX10396, TCU13515, M131739

WARNING (B)

AVOID CRUSHING

- Keep Rollover Protective Structure fully extended
- Do not jump if machine tips
- Use seat belt

When structure must be down

- DO NOT use seat belt
- Drive with extra care

DANGER (B)

To avoid injury from rotating blades, stay clear of deck edge.

WARNING (C)

Hot surface.

DANGER/POISON (D)

- Shield Eyes: Explosive gases can cause blindness or injury.
- NO
 - Sparks
 - Flames
 - Smoking
- Sulfuric acid can cause blindness or severe burns.
- Flush eyes immediately with water. Get medical help fast.
- Keep out of reach of children.
- Do not tip.
- Do not open battery.

Emission Control System Certification Label

NOTE: Tampering with emission controls and components by unauthorized personnel may result in severe fines or penalties. Emission controls and components can only be adjusted by EPA and/or CARB authorized service centers. Contact your John Deere Commercial and Consumer Equipment Retailer concerning emission controls and component questions.

The presence of an emissions label signifies that the engine has been certified with the United States Environmental Protection Agency (EPA) and/or California Air Resources Board (CARB).

The emissions warranty applies only to those engines marketed by John Deere that have been certified by the EPA and/or CARB; and used in the United States and Canada in off-road mobile equipment.

Emission Compliance Period

If your engine has the emission compliance category listed on the emission control system certification or air index label, this indicates the number of operating hours for which the engine has been certified to meet EPA and/or CARB emission requirements. The following table provides the engine compliance period in hours associated with the category found on the certification label.

SAFETY LABELS

Agency	Category	Hours
EPA	C	250
EPA	B	500
EPA	A	1000
CARB	Moderate	125
CARB	Intermediate	250
CARB	Extended	500

Certification

Your product has been tested and evaluated by the manufacturer and conforms with American National Standard B-71.4, "Safety Specifications" for commercial turf care equipment.

Canadian Electromagnetic Compatibility (EMC) Compliance

This spark ignition system complies with Canadian ICES-002.

SAFETY

Operator Training Required

- Read the operator's manual and other training material. If the operator or mechanic cannot read English, it is the owner's responsibility to explain this material to them. This publication is available in other languages.
- Become familiar with the safe operation of the equipment, operator controls, and safety signs.
- All operators and mechanics should be trained. The owner of the machine is responsible for training the users.
- Never let children or untrained people operate or service the equipment. Local regulations may restrict the age of the operator.
- The owner/user can prevent and is responsible for accidents or injuries occurring to themselves, other people, or property.
- Operate the machine in an open, unobstructed area under the direction of an experienced operator.

Preparation

- Evaluate the terrain to determine what accessories and attachments are needed to properly and safely perform the job. Only use accessories and attachments approved by the manufacturer.
- Wear appropriate clothing including hard hat, safety glasses and hearing protection. Long hair, loose clothing or jewelry may get tangled in moving parts.
- Inspect the area where the equipment is to be used and remove all objects such as rocks, toys and wire which can be thrown by the machine.
- Use extra care when handling gasoline and other fuels. They are flammable and vapors are explosive.
 - a. Use only an approved container.
 - b. Never remove gas cap or add fuel when engine is running. Do not smoke.
 - c. Never refuel or drain the machine indoors.
- Check that the operator's presence controls, safety switches and shields are attached and functioning properly. Do not operate unless they are functioning properly.

Operating Safely

- Never run an engine in an enclosed area where dangerous carbon monoxide fumes can collect.
- Only operate in good light, keeping away from holes and hidden hazards.
- Be sure all drives are in neutral and parking brake is

engaged before starting engine. Only start engine from the operator's position. Use seat belts if provided.

- Slow down and use extra care on hillsides. Be sure to travel in the recommended direction on hillsides. For this machine, drive across hillsides, not up and down. Turf conditions can affect the machine's stability. Use caution while operating near drop-offs.
- Slow down and use caution when making turns and when changing directions on slopes.
- Never raise deck with the blades running.
- Never operate with the PTO shield, or other guards, not securely in place. Be sure all interlocks are attached, adjusted properly, and functioning properly.
- Never operate with the discharge deflector raised, removed or altered, unless using a grasscatcher. Do not operate mower without discharge chute or entire grasscatcher in place.
- Do not change the engine governor setting or overspeed the engine. Operating the engine at excessive speed can increase the hazard of personal injury.
- Stop on level ground, lower implements, disengage drives, engage parking brake, and shut off engine before leaving the operator's position for any reason including emptying the grasscatchers or unclogging the chute.
- Stop equipment and inspect blades after striking objects or if an abnormal vibration occurs. Make necessary repairs before resuming operations.
- Keep hands and feet away from the cutting units.
- Look behind and down before backing up to be sure of a clear path.
- Never carry passengers and keep pets and bystanders away.
- Slow down and use caution when making turns and crossing roads and sidewalks. Stop blades if not mowing. Watch for traffic when operating near or crossing roadways.
- Be aware of the mower discharge direction and do not point it at anyone.
- Do not operate the machine while under the influence of alcohol or drugs.
- Use care when loading or unloading the machine into or off of a trailer or truck.
- Use care when approaching blind corners, shrubs, trees, or other objects that may obscure vision.
- Inspect machine before you operate. Be sure hardware is tight. Repair or replace damaged, badly worn, or missing parts. Be sure guards and shields are in good condition and fastened in place. Make any necessary adjustments before you operate.

SAFETY

- Before using, always visually inspect to see that the blades, blade bolts and the mower assembly are not worn and damaged. Replace worn and damaged blades and bolts in sets to preserve balance.
- Keep safety labels visible when installing accessories and attachments.
- Do not wear radio or music headphones. Safe service and operation require your full attention.
- When machine is left unattended, stored, or parked, lower the mower deck unless a positive mechanical lock is used.

Using a Spark Arrestor

The engine in this machine is not equipped with a spark arrestor muffler. It is a violation of California Public Resource Code Section 4442 to use or operate this engine on or near any forest-covered, brush-covered or grass-covered land unless the exhaust system is equipped with a spark arrestor meeting any applicable local or state laws. Other states or federal areas may have similar laws.

A spark arrestor for your machine may be available from your authorized dealer. An installed spark arrestor must be maintained in good working order by the operator.

Checking Mowing Area

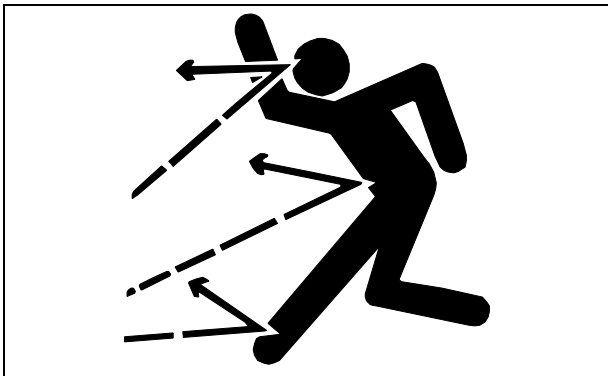

- Clear mowing area of objects that might be thrown. Keep people and pets out of mowing area.
- Low-hanging branches and similar obstacles can injure the operator or interfere with mowing operation. Before mowing, identify potential obstacles such as low-hanging branches, and trim or remove those obstacles.
- Study mowing area. Set up a safe mowing pattern. Do not mow where traction or stability is doubtful.
- Test drive area with mower lowered but not running. Slow down when you travel over rough ground.

Parking Safely

1. Stop machine on a level surface, not on a slope.
2. Move motion control levers out to the neutral lock position.
3. Disengage mower blades.
4. Lower attachments to the ground.
5. Lock the park brake.
6. Stop the engine.
7. Remove the key.
8. Wait for engine and all moving parts to stop before you leave the operator's seat.
9. Close fuel shut-off valve, if your machine is equipped.
10. Disconnect the negative battery cable or remove the spark plug wire (for gasoline engines) before servicing the machine.

Rotating Blades are Dangerous

HELP PREVENT SERIOUS OR FATAL ACCIDENTS:

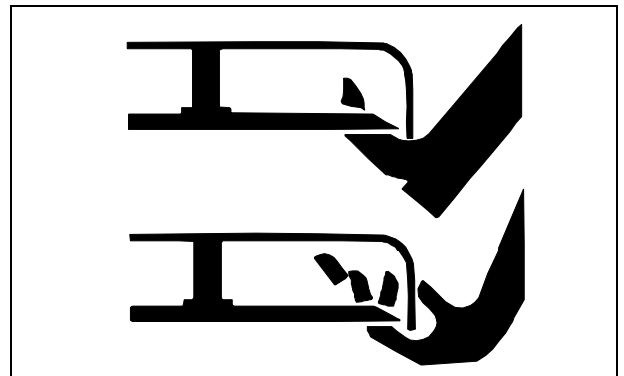

- Rotating blades can cut off arms and legs, and throw objects. Failure to observe safety instructions could result in serious injury or death.
- Keep hands, feet and clothing away from mower deck when engine is running.
- Be alert at all times, drive forward carefully. People, especially children can move quickly into the mowing area before you know it.
- Do not mow in reverse.
- Shut off blades when you are not mowing.
- Park machine safely before leaving the operator station for any reason including emptying the catchers or unplugging the chute.

SAFETY

Protect Children

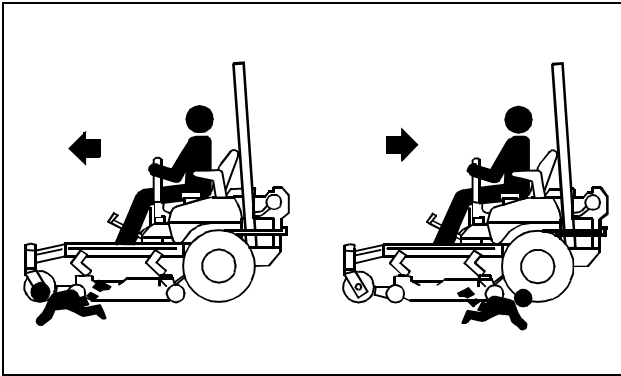

- Death or serious injury can occur when young children associate having fun with a lawn mowing machine simply because someone has given them a ride on a machine.
- Children are attracted to lawn mowing machines and mowing activities. They don't understand the dangers of rotating blades or the fact that the operator is unaware of their presence.
- Children who have been given rides in the past may suddenly appear in the mowing area for another ride and be run over or backed over by the machine.
- Tragic accidents with children can occur if the operator is not alert to the presence of children, especially when a child approaches a machine from behind. Before and while backing up, stop mower blades and look down and behind the machine carefully, especially for children.
- Never carry children on a machine or attachment, even with the blades off. Do not tow children in a cart or trailer. They can fall off and be seriously injured or interfere with safe machine operation.
- Never use the machine as a recreational vehicle or to entertain children.
- Never allow children or an untrained person operate the machine. Instruct all operators not to give children a ride on the machine or in an attachment.
- Keep children indoors, out of the mowing area, and in the watchful eye of a responsible adult, other than the operator, when a mower is being operated.
- Stay alert to the presence of children. Never assume that children will remain where you last saw them. Turn the machine off if a child enters the work area.

Avoid Tipping

- Slopes are a major factor related to loss-of-control and tip-over accidents, which can result in severe injury or death. Operation on all slopes requires extra caution.

- If you feel uneasy on a hillside, do not mow it.
- Mow across slopes, not up and down.
- Watch for holes, ruts, bumps, rocks, or other hidden objects. Uneven terrain could overturn the machine. Tall grass can hide obstacles.
- Choose a low ground speed so you will not have to stop or shift while on a slope.
- Do not mow or operate machine on wet grass. Tires may lose traction. Tires may lose traction on slopes even though the brakes are functioning properly.
- Avoid starting, stopping or turning on a slope. If the tires lose traction, disengage the blades and proceed slowly, straight down the slope.
- Keep all movement on slopes slow and gradual. Do not make sudden changes in speed or direction, which could cause the machine to roll over.
- Use extra care while operating machine with grasscatchers or other attachments, they can affect stability of the machine. Do not use on steep slopes.
- Do not mow near drop-offs, ditches, embankments, or bodies of water. The machine could suddenly roll over if a wheel goes over the edge or the edge caves in.
- Follow the manufacturer's recommendations for wheel weights or counterweights for added stability when operating on slopes or using front or rear mounted attachments. Remove weights when not required.
- Drive machine very slowly and avoid quick stops when attachment is removed.
- Transport machine with decks lowered to improve stability.

Use Seat Belt Properly

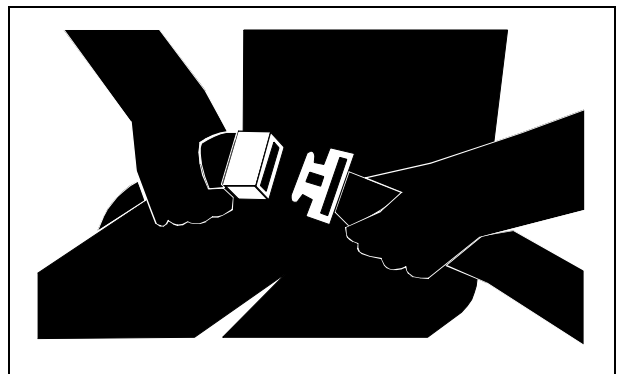

- Use a seat belt when operating with the folding Roll-Over Protective Structure (ROPS) in the upright position to minimize chance of injury from an accident, such as an

SAFETY

overturn.

Do not use a seat belt when operating with the folding ROPS in the folded position. Return the folding ROPS to the upright position as soon as possible.

- Never modify, disassemble or attempt to repair the seat belt.
- Replace entire seat belt if mounting hardware, buckle, belt, or retractor show signs of damage.
- Inspect seat belt and mounting hardware at least once a year. Look for signs of loose hardware or belt damage, such as cuts, fraying, extreme or unusual wear, discoloration, or abrasion. Replace only with replacement parts approved by your John Deere dealer.
- Layers of heavy clothing can interfere with proper positioning of the seat belt and can reduce the effectiveness of the seat belt.

Keep ROPS Installed Properly

- Make certain all parts of the ROPS are installed correctly if the ROPS structure is loosened or removed for any reason. All ROPS hardware should be tightened to the proper torque per manufacturer's recommendations.
- Any alteration of the ROPS must be approved by the manufacturer. The protection provided by the ROPS will be impaired if the ROPS is subjected to structural damage, is involved in an overturn incident, or is in any way altered by welding, bending, drilling, or cutting.
- Never attempt to repair a damaged or altered ROPS. It must be replaced to maintain the manufacturer's certification of the structure.

Keep Riders Off

- Only allow the operator on the machine. Keep riders off.
- Riders on the machine or attachment may be struck by foreign objects or thrown off the machine causing serious injury.
- Riders obstruct the operator's view resulting in the machine being operated in an unsafe manner.

Avoid High Pressure Fluids



MIF

- Hydraulic hoses and lines can fail due to physical damage, kinks, age, and exposure. Check hoses and lines regularly. Replace damaged hoses and lines.
- Hydraulic fluid connections can loosen due to physical damage and vibration. Check connections regularly. Tighten loose connections.
- Escaping fluid under pressure can penetrate the skin causing serious injury. Avoid the hazard by relieving pressure before disconnecting hydraulic or other lines. Tighten all connections before applying pressure.
- Search for leaks with a piece of cardboard. Protect hands and body from high pressure fluids.
- If an accident occurs, see a doctor immediately. Any fluid injected into the skin must be surgically removed within a few hours or gangrene may result. Doctors unfamiliar with this type of injury should reference a knowledgeable medical source. Such information is available from Deere & Company Medical Department in Moline, Illinois, U.S.A. Information may be obtained in the United States and Canada only by calling 1-800-822-8262.

Driving Safely on Public Roads

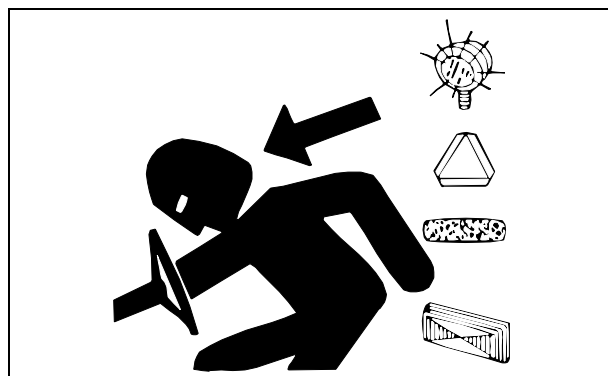

Avoid personal injury or death resulting from a collision with

SAFETY

another vehicle on public roads:

- Use safety lights and devices. Slow moving machines when driven on public roads are hard to see, especially at night.
- Whenever driving on public roads, use flashing warning lights and turn signals according to local regulations. Extra flashing warning lights may need to be installed.

Checking Wheel Hardware

- A serious accident could occur causing serious injury if wheel hardware is not tight.
- Check wheel hardware tightness often during the first 100 hours of operation.
- Wheel hardware must be tightened to specified torque using the proper procedure anytime it is loosened.

Wear Appropriate Clothing

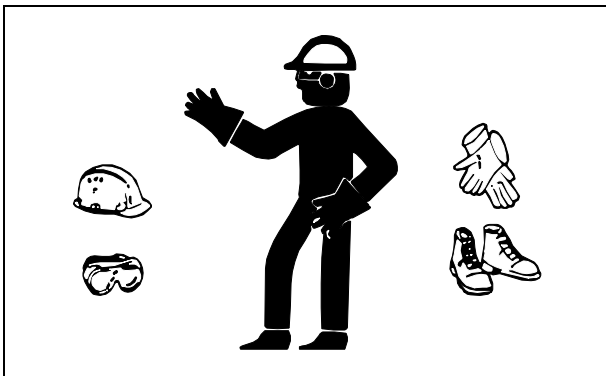

MIF

- Always wear safety goggles, or safety glasses with side shields, and a hard hat when operating the machine.
- Wear close fitting clothing and safety equipment appropriate for the job.
- While mowing, always wear substantial footwear and long trousers. Do not operate the equipment when barefoot or wearing open sandals.
- Wear a suitable protective device such as earplugs. Loud noise can cause impairment or loss of hearing.

Maintenance and Storage



MIF

- Never operate machine in a closed area where dangerous carbon monoxide fumes can collect.
- Disengage drives, lower implement, lock parking brake, stop engine and remove key or disconnect spark plug (for gas engines). Wait for all movement to stop before adjusting, cleaning or repairing.
- Clean grass and debris from cutting units, drives, mufflers, and engine to help prevent fires. Clean up oil or fuel spillage.
- Let engine cool before storing and do not store near flame.
- Shut off fuel while storing or transporting. Do not store fuel near flames or drain indoors.
- Park machine on level ground. Never allow untrained personnel to service machine. Understand service procedure before doing work.
- Use jack stands or lock service latches to support components when required. Securely support any machine elements that must be raised for service work.
- Before servicing machine or attachment, carefully release pressure from any components with stored energy, such as hydraulic components or springs.
- Release hydraulic pressure by lowering attachment or cutting units to the ground or to a mechanical stop and move hydraulic control levers back and forth.
- Disconnect battery or remove spark plug (for gas engines) before making any repairs. Disconnect the negative terminal first and the positive last. Reconnect positive first and negative last.
- Use care when checking blades. Wrap the blades or wear gloves, and use caution when servicing them. Only replace blades. Never straighten or weld them.
- Keep hands, feet, clothing, jewelry and long hair away from moving parts. If possible, do not make adjustments with the engine running.

SAFETY

- Charge batteries in an open well ventilated area, away from spark and flames. Unplug charger before connecting or disconnecting from battery. Wear protective clothing and use insulated tools.
- Keep all parts in good working condition and all hardware tightened. Replace all worn or damaged decals.
- Check grasscatcher components and the discharge guard frequently and replace with manufacturer's recommended parts, when necessary. Grasscatcher components are subject to wear, damage, and deterioration which could expose moving parts or allow objects to be thrown.
- Keep all nuts and bolts tight, especially blade attachment bolts, to be sure the equipment is in safe working condition.
- Check brake operation frequently. Adjust and service as required.
- On multi-bladed machines, take care as rotating one blade can cause other blades to rotate.

Prevent Fires

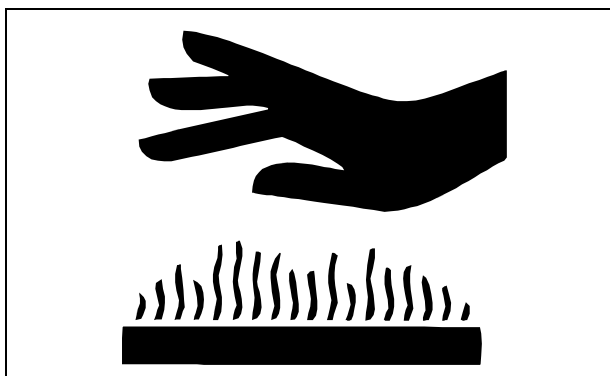

- Remove grass and debris from engine compartment and muffler area, before and after operating machine, especially after mowing or mulching in dry conditions.
- Empty the grasscatcher completely before storing.
- Always shut off fuel when storing or transporting machine, if the machine has a fuel shutoff.
- Do not store machine near an open flame or source of ignition, such as a water heater or furnace.
- Check fuel lines, tank, cap, and fittings frequently for cracks or leaks. Replace if necessary.

Tire Safety



Explosive separation of a tire and rim parts can cause serious injury or death:

- Do not attempt to mount a tire without the proper equipment and experience to perform the job.
- Always maintain the correct tire pressure. Do not inflate the tires above the recommended pressure. Never weld or heat a wheel and tire assembly. The heat can cause an increase in air pressure resulting in a tire explosion. Welding can structurally weaken or deform the wheel.
- When inflating tires, use a clip-on chuck and extension hose long enough to allow you to stand to one side and NOT in front of or over the tire assembly.
- Check tires for low pressure, cuts, bubbles, damaged rims or missing lug bolts and nuts.

Handling Fuel Safely

To avoid personal injury or property damage, use extreme care in handling fuel. Fuel is extremely flammable and fuel vapors are explosive:



- Extinguish all cigarettes, cigars, pipes, and other sources of ignition.

SAFETY

- Use only an approved fuel container. Use only non-metal, portable fuel containers approved by the Underwriter's Laboratory (U.L.) or the American Society for Testing & Materials (ASTM). If using a funnel, make sure it is plastic and has no screen or filter.
- Never remove the fuel tank cap or add fuel with the engine running. Allow engine to cool before refueling.
- Never add fuel to or drain fuel from the machine indoors. Move machine outdoors and provide adequate ventilation.
- Clean up spilled fuel immediately. If fuel is spilled on clothing, change clothing immediately. If fuel is spilled near machine, do not attempt to start the engine but move the machine away from the area of spillage. Avoid creating any source of ignition until fuel vapors have dissipated.
- Never store the machine or fuel container where there is an open flame, spark, or pilot light such as on a water heater or other appliance.



- Prevent fire and explosion caused by static electric discharge. Static electric discharge can ignite fuel vapors in an ungrounded fuel container.
- Never fill containers inside a vehicle or on a truck or trailer bed with a plastic liner. Always place containers on the ground away from your vehicle before fueling.
- Remove fuel-powered equipment from the truck or trailer and refuel it on the ground. If this is not possible, then refuel such equipment with a portable container, rather than from a fuel dispenser nozzle.
- Keep the nozzle in contact with the rim of the fuel tank or container opening at all times until the fueling is complete. Do not use a nozzle lock-open device.
- Never overfill fuel tank. Replace fuel tank cap and tighten securely.
- Replace all fuel container caps securely after use.
- For gasoline engines, do not use gas with methanol. Methanol is harmful to your health and to the environment.

Handling Waste Product and Chemicals

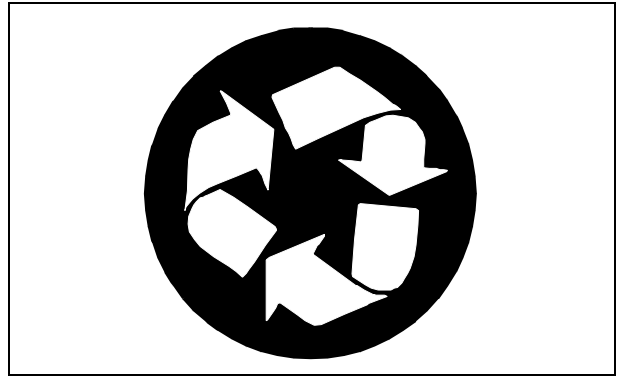

Waste products, such as, used oil, fuel, coolant, brake fluid, and batteries, can harm the environment and people:

- Do not use beverage containers for waste fluids - someone may drink from them.
- See your local Recycling Center or authorized dealer to learn how to recycle or get rid of waste products.
- A Material Safety Data Sheet (MSDS) provides specific details on chemical products: physical and health hazards, safety procedures, and emergency response techniques. The seller of the chemical products used with your machine is responsible for providing the MSDS for that product.

OPERATING

Daily Operating Checklist

- Make sure all necessary guards and shields are safely and securely attached. Check for loose, missing, or damaged parts.
- Remove mower deck belt shields. Clean grass and debris from belt area.
- Remove grass and debris from machine and mower deck.
- Test park brake.
- Test safety systems.
- Check battery.
- Check for oil leaks.
- Check engine and hydraulic oil levels.
- Check all belts for damage or cracking.
- Check engine air filter.
- Check mower level.
- Adjust cutting height if necessary.
- Check wheel bolt torque. Tighten if necessary.
- Check tire air pressure. Check tires for damage or cracking.
- Check and adjust steering control linkages.
- Lubricate front caster spindles.
- Check for proper operation of seat latch.

Avoid Damage to Plastic and Painted Surfaces

- Do not wipe plastic parts unless rinsed first.
- Insect repellent spray may damage plastic and painted surfaces. Do not spray insect repellent near machine.
- Be careful not to spill fuel on machine. Fuel may damage surface. Wipe up spilled fuel immediately.

Operator Station Controls

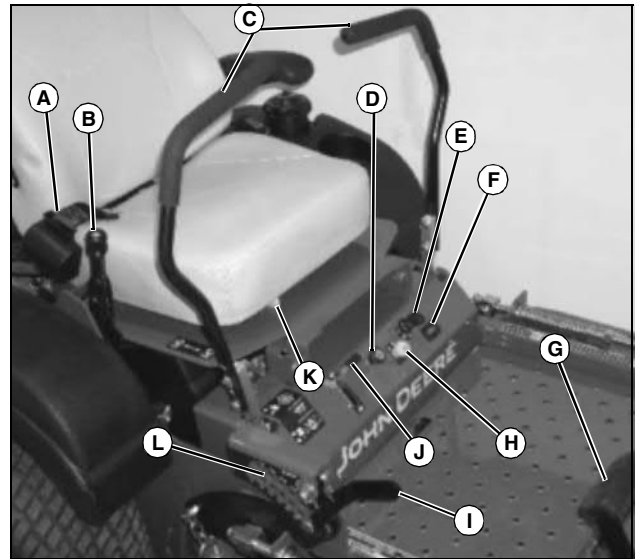

MX21475

- A - Seat Belt**
- B - Park Brake Lever**
- C - Motion Control Levers**
- D - Choke**
- E - Ignition Key Switch**
- F - Hourmeter**
- G - Mower Deck Lift/Lower Pedal**
- H - PTO Knob**
- I - Mower Deck Transport Position Lock Lever**
- J - Throttle Lever**
- K - Seat Adjustment Lever**
- L - Height-of-Cut (HOC) Adjustment Pin**

Miscellaneous Controls

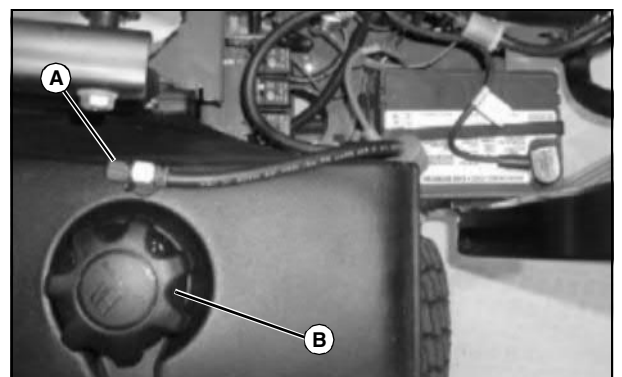

MX21549

- A - Fuel Shut-Off Valve**
- B - Fuel Tank Cap**

OPERATING

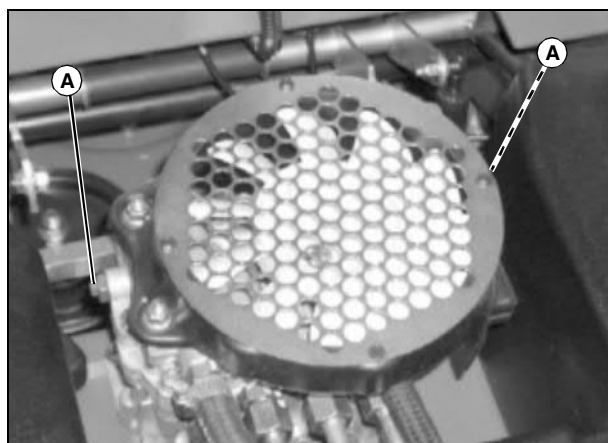

MX21383

A - Free-Wheeling Pump Release Valves

2. Push operator seat back and slowly lower seat frame.
3. Ensure latch is fully engaged.

Mounting and Dismounting Machine Safely

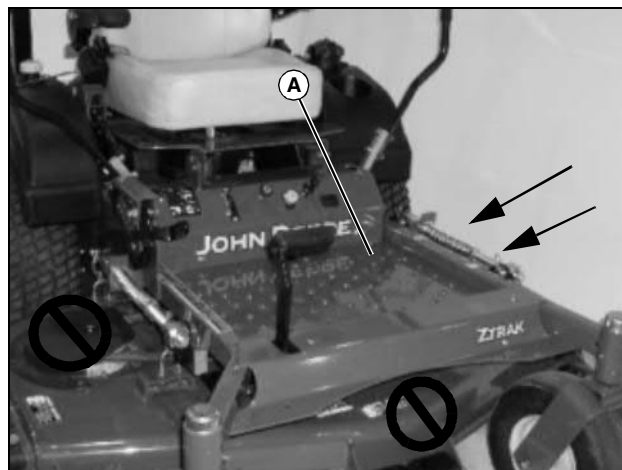

MX21477

Do not step on the mower deck when mounting and dismounting the machine. Mount the machine from the left side using the foot plate (A). Park machine safely (see Parking Safely in the SAFETY section) before dismounting.

Keep the foot plate clean.

Raising and Lowering Operator Seat

CAUTION: Avoid injury! The seat is heavy and can cause injury if it falls. When performing any service function under the operator seat, make sure the seat is tilted forward and rests against the hinge stops.

Raising the Seat

1. Park machine safely. (See Parking Safely in the SAFETY section.)

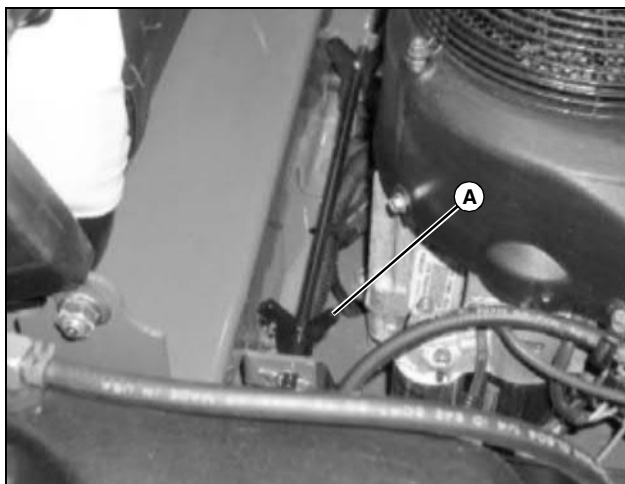

MX21551

2. Disengage seat latch (A) to release. Hold latch released while lifting seat frame forward until it rests against the hinge stops.

Lowering the Seat

1. Stand on the side of the machine.

Adjusting Seat

1. Sit on operator seat.

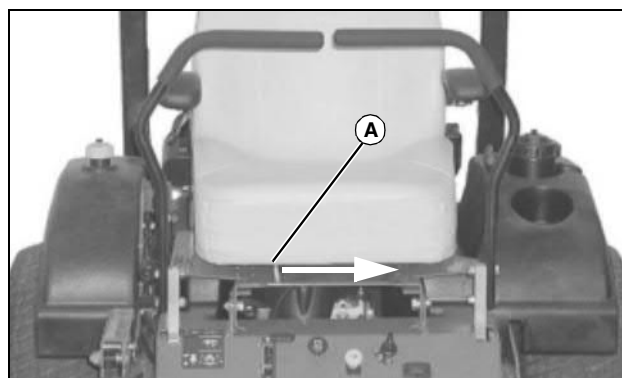

MX21226

2. Push and hold the seat adjustment lever (A) toward the middle of the seat.
3. Slide forward or backward to desired position.
4. Release lever.

OPERATING

Using Seat Belt



CAUTION: Avoid injury! Always wear seat belt when operating machine with ROPS in upright position. If ROPS must be folded to operate in a low clearance area, do not use seat belt. Raise ROPS and use seat belt as soon as conditions permit.

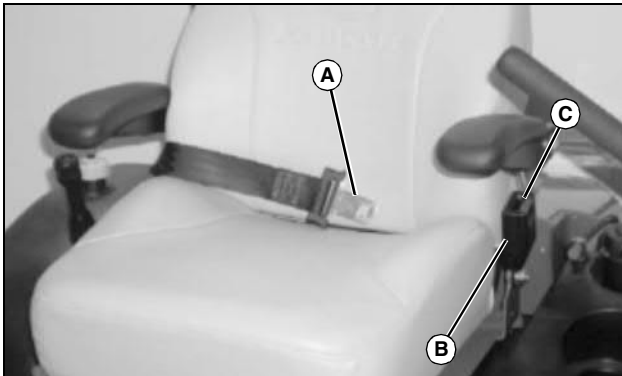

MX21379

1. Sit in seat.
2. Pull out seat belt buckle (A) and stretch across your lap in one nonstop motion.
3. Insert seat belt buckle into latch (B) until it locks.
4. To release seat belt, press red button (C) until buckle comes out of latch.

Lowering ROPS



CAUTION: Avoid injury! Use roll-over protection system (ROPS) in lowered position only when low clearance operation is necessary.

- Do not use seat belt when ROPS is in lowered position.
- Do not operate machine on slope with ROPS in folded position.
- Raise ROPS and fasten seat belt as soon as conditions permit.

1. Park machine safely. (See Parking Safely in the SAFETY section.)

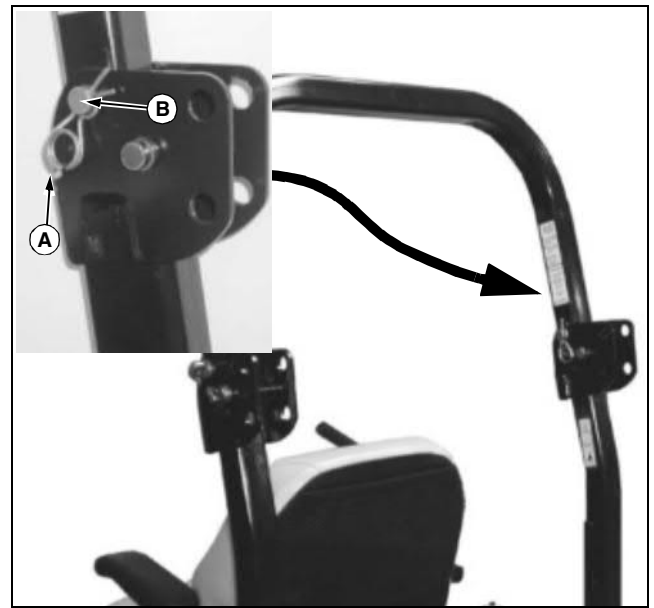

MX21309, MX21381

2. Remove spring pin (A) from drilled pin (B) on left and right sides of ROPS.
3. Remove drilled pin from left and right sides of ROPS.



CAUTION: Avoid injury! Fingers and hands can be pinched or crushed. Be aware of potential pinch points and keep hands away.



MX21380

4. Pull ROPS rearward to lower.
5. Install drilled pins and spring pins back into holes in ROPS to secure in place.

Raising ROPS

1. Park machine safely. (See Parking Safely in the SAFETY section.)



Suggest:

If the above button click is invalid.

Please download this document

first, and then click the above link

to download the complete manual.

Thank you so much for reading

OPERATING

Adjusting Mower Deck Cutting Height

CAUTION: Avoid injury! Before adjusting cutting height, stop engine and lock the park brake.

Cutting height can be adjusted from approximately 38 to 127 mm (1-1/2 to 5 in.). Each hole adjusts the height-of-cut (HOC) in approximately 6 mm (1/4 in.) increments.

The deck can also be raised and locked in a transport position, to provide maximum ground clearance when moving the machine from one area to another.

1. Park machine safely. (See Parking Safely in the SAFETY section.)

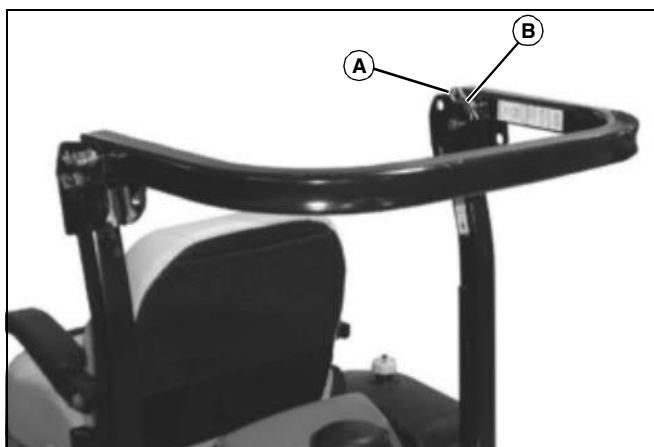

MX21380

2. Remove spring pin (A) from drilled pin (B) on left and right sides of ROPS.
3. Remove drilled pin from left and right sides of ROPS.

CAUTION: Avoid injury! Fingers and hands can be pinched or crushed. Be aware of potential pinch points and keep hands away.

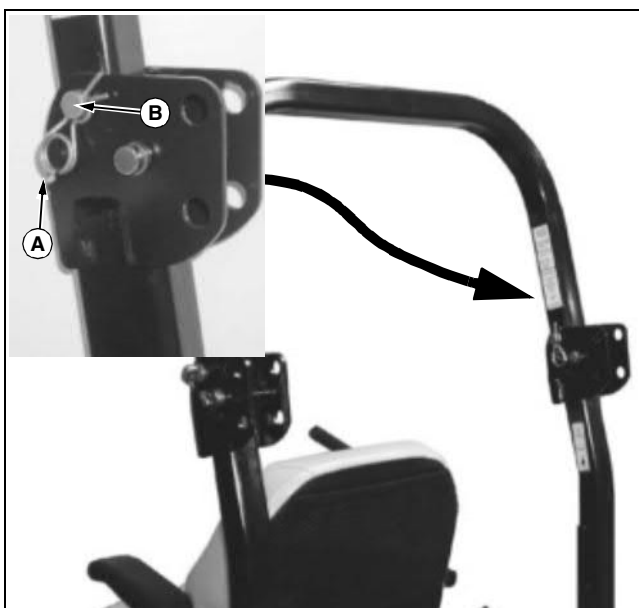

MX21309, MX21381

4. Push ROPS into upright position.
5. Install drilled pin (B) into holes on left and right sides of ROPS, and secure in place with spring pins (A).
6. Check the ROPS bolt torque if the ROPS is loose.

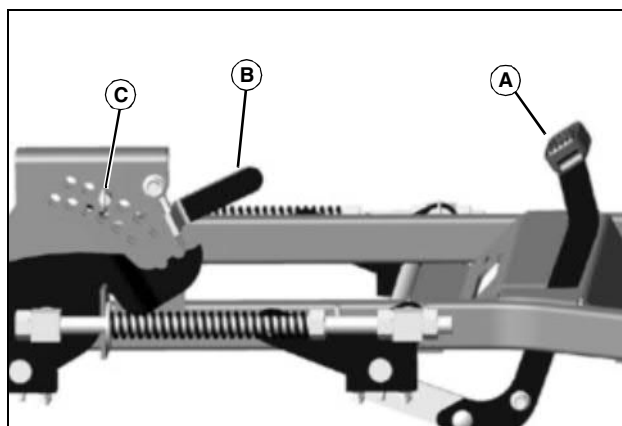

MX18449

2. Depress the mower deck lift/lower pedal (A) until the transport position lock lever (B) engages.
3. Position the HOC adjustment pin (C) in the proper hole for the desired height-of-cut.
4. Depress the mower deck lift/lower pedal (A) and release the transport position lock lever (B).

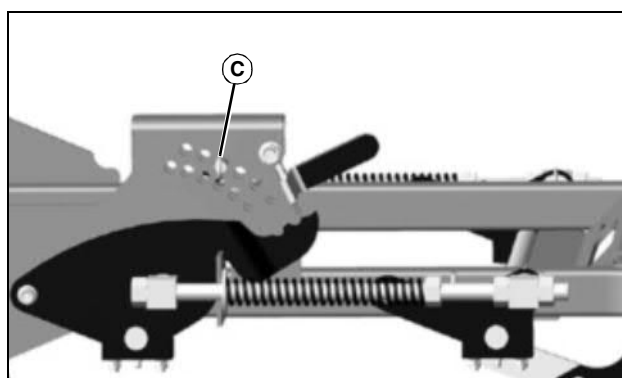

MX18449

5. Lower the mower deck until it rests against the HOC adjustment pin (C).

<https://www.ebooklibonline.com>

Hello dear friend!

Thank you very much for reading.

Enter the link into your browser.

The full manual is available for immediate download.

<https://www.ebooklibonline.com>