

JOHN DEERE
WORLDWIDE COMMERCIAL & CONSUMER
EQUIPMENT DIVISION

Mower Decks
48 and 54 Inch

OMM145184 K0

OPERATOR'S MANUAL



North American Version
Litho in U.S.A.

INTRODUCTION

Thank You for Purchasing a John Deere Product

We appreciate having you as a customer and wish you many years of safe and satisfied use of your machine.

Using Your Operator's Manual

This manual is an important part of your machine and should remain with the machine when you sell it.

Reading your operator's manual will help you and others avoid personal injury or damage to the machine. Information given in this manual will provide the operator with the safest and most effective use of the machine. Knowing how to operate this machine safely and correctly will allow you to train others who may operate this machine.

This manual and safety signs on your machine may also be available in other languages (see your John Deere dealer to order).

Sections in your operator's manual are placed in a specific order to help you understand all the safety messages and learn the controls so you can operate this machine safely. You can also use this manual to answer any specific operating or servicing questions. A convenient index located at the end of this book will help you to find needed information quickly.

The machine shown in this manual may differ slightly from your machine, but will be similar enough to help you understand our instructions.

RIGHT-HAND and LEFT-HAND sides are determined by facing in the direction the machine will travel when going forward. When you see a broken line arrow (----->), the item referred to is hidden from view.

Before delivering this machine, your dealer performed a predelivery inspection to ensure best performance.

Special Messages

Your manual contains special messages to bring attention to potential safety concerns, machine damage as well as helpful operating and servicing information. Please read all the information carefully to avoid injury and machine damage.



CAUTION: Avoid injury! This symbol and text highlight potential hazards or death to the operator or bystanders that may occur if the hazards or procedures are ignored.

IMPORTANT: Avoid damage! This text is used to tell the operator of actions or conditions that might result in damage to the machine.

NOTE: General information is given throughout the manual that may help the operator in the operation or service of the machine.

PRODUCT IDENTIFICATION

Record Identification Numbers

Mower Decks for 425, 445 and 455 Lawn and Garden Tractors

48 and 54 Inch Serial No. (010001 -)

If you need to contact an Authorized Service Center for information on servicing, always provide the product model and serial number.

You will need to locate the serial number for the machine and for the engine. Record the information in the spaces provided below.

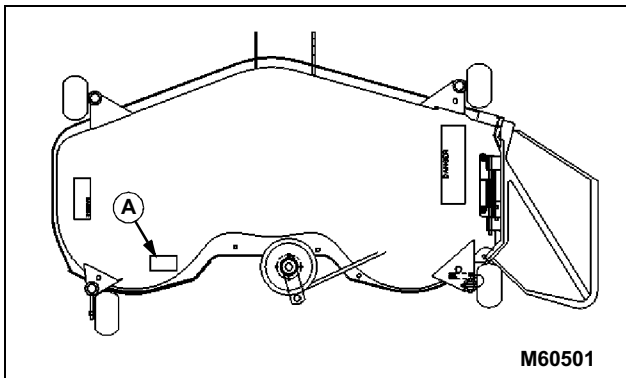

DATE OF PURCHASE:

DEALER NAME:

DEALER PHONE:

SERIAL NUMBER (A):

<https://www.ebooklibonline.com>

Hello dear friend!

Thank you very much for reading.

Enter the link into your browser.

The full manual is available for immediate download.

<https://www.ebooklibonline.com>

TABLE OF CONTENTS

Safety	5
Installing	9
Removing	11
Operating	13
Replacement Parts	19
Service Intervals	20
Service	21
Troubleshooting	26
Storage	27
Assembly	28
Specifications	30
Index	31

All information, illustrations and specifications in this manual are based on the latest information at the time of publication. The right is reserved to make changes at any time without notice.

COPYRIGHT© 2000
Deere & Co.

John Deere Worldwide Commercial and
Consumer Equipment Division
Horicon, WI

All rights reserved
Previous Editions
COPYRIGHT© 1994

OMM145184 K0 - English

SAFETY

Understanding The Machine Safety Labels

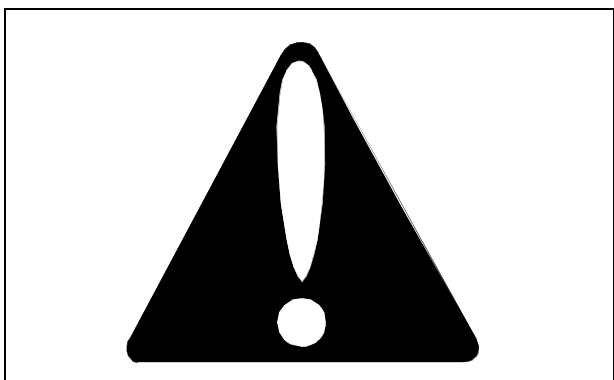

The machine safety labels shown in this section are placed in important areas on your machine to draw attention to potential safety hazards.

On your machine safety labels, the words DANGER, WARNING, and CAUTION are used with this safety-alert symbol, (▲). DANGER identifies the most serious hazards.

The operator's manual also explains any potential safety hazards whenever necessary in special safety messages that are identified with the word, CAUTION, and the safety-alert symbol, (▲).

DANGER:

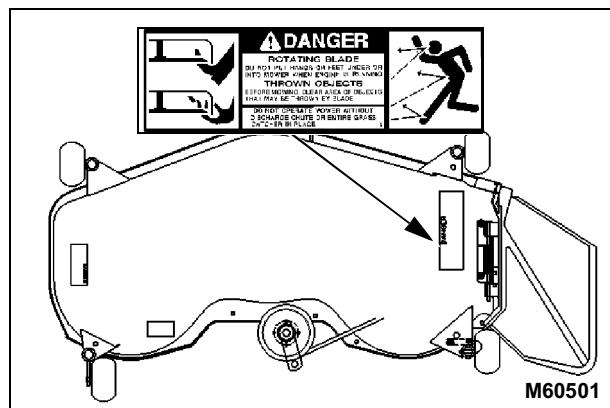

ROTATING BLADE

DO NOT PUT HANDS OR FEET UNDER OR INTO MOWER WHEN ENGINE IS RUNNING

THROWN OBJECTS

BEFORE MOWING, CLEAR AREA OF OBJECTS THAT MAY BE THROWN BY BLADE

DO NOT OPERATE MOWER WITHOUT DISCHARGE CHUTE OR ENTIRE GRASS CATCHER IN PLACE

DANGER: ROTATING BLADE

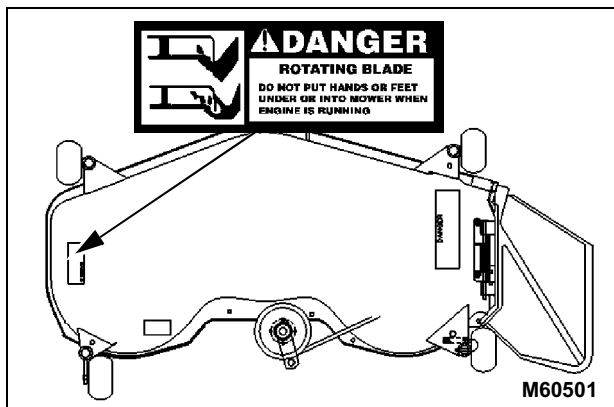

DO NOT PUT HANDS OR FEET UNDER OR INTO MOWER WHEN ENGINE IS RUNNING

Certification

Your mower has been certified by an independent laboratory for compliance with American National Standard B-71.1, "Safety Specifications" for Power Lawn Mowers, Lawn and Garden Tractors, and Lawn Tractors.

Operating Safely



- Read, understand and follow all instructions in the manual and on the machine before starting.
- Only allow responsible adults, who are familiar with the

SAFETY

instructions to operate the machine.

- Inspect machine before you operate. Be sure hardware is tight. Repair or replace damaged, badly worn, or missing parts. Be sure guards and shields are in good condition and fastened in place. Make any necessary adjustments before you operate.
- Check brake action before you operate. Adjust or service brakes as necessary.
- Stop machine if anyone enters the area.
- If you hit an object, stop the machine and inspect it. Make repairs before you operate. Keep machine and attachments properly maintained and in good working order.
- Be aware of the mower discharge direction and make sure that no one is in the path of the discharge direction.
- Do not leave machine unattended when it is running.
- Only operate during daylight or with good artificial light.
- Be careful of traffic when operating near or crossing roadways.
- Do not wear radio or music headphones while operating the machine. Safe operation requires your full attention.
- Older adults are involved in a large percentage of riding mower accidents involving injury. These operators should evaluate their ability to operate a mower safely enough to protect the operator and others from serious injury.

Checking Mowing Area

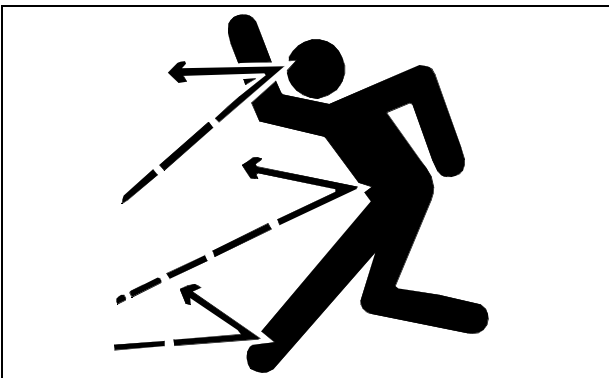

- Clear mowing area of objects that might be thrown. Keep people and pets out of mowing area.
- Study mowing area. Set up a safe mowing pattern. Do not mow where traction or stability is doubtful.
- Test drive area with mower lowered but not running. Slow down when you travel over rough ground.

Parking Safely

1. Stop machine on a level surface, not on a slope.
2. Disengage Power Take-Off (PTO).
3. Lower attachments to the ground.
4. Lock the park brake.
5. Stop the engine.
6. Remove the key.
7. Wait for engine and all moving parts to stop before you leave the operator's seat.
8. Close fuel shut-off valve, if your machine is equipped.

Rotating Blades are Dangerous

Help Prevent Serious Or Fatal Accidents:

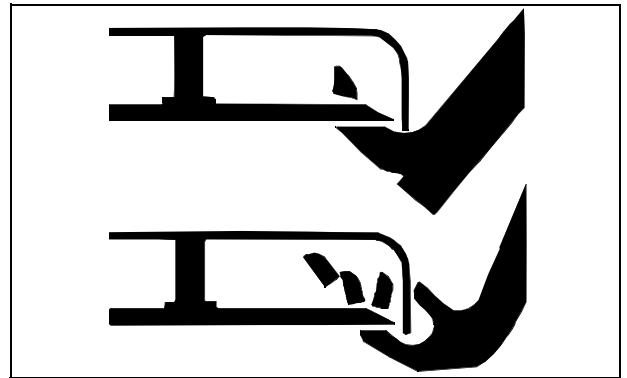

- Rotating blades can cut off arms and legs.
- Keep hands, feet and clothing away from mower deck when engine is running.
- Be alert at all times, drive forward carefully. People, especially children can move quickly into the mowing area before you know it.
- Before backing up, shut off PTO and look down and behind the machine carefully, especially for children.
- Do not mow in reverse.
- Shut off blades when you are not mowing.
- Do not operate machine if you are under the influence of drugs or alcohol.
- Park machine safely before inspecting or unplugging mower or bagger.

SAFETY

Protect Children:

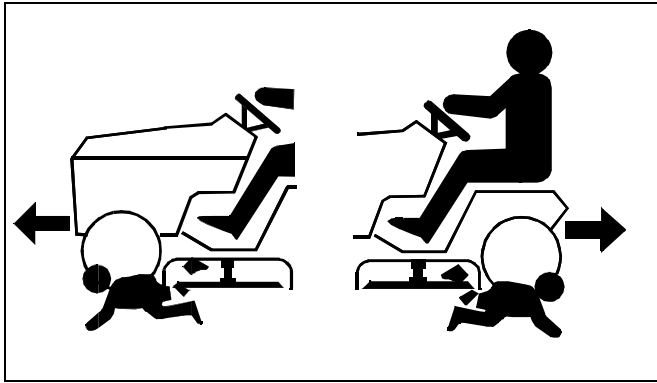

- Never assume that children will remain where you last saw them. Children are attracted to mowing activity, stay alert to the presence of children.
- Keep children indoors when you are mowing. Turn the machine off if a child enters the mowing area.
- Use extra care when you come to blind corners, shrubs, trees, or other objects that may block your vision.
- Do not let children or an untrained person operate the machine.
- Do not carry or let children ride on any attachment or machine even with the blades off. Do not tow children in a cart or trailer.

Wear Appropriate Clothing

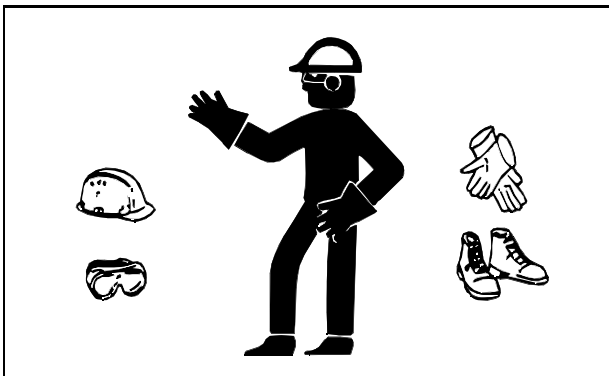

- Wear close fitting clothing and safety equipment appropriate for the job.
- Always wear safety goggles or safety glasses with side shields when operating the mower.
- Wear a suitable protective device such as earplugs. Loud noise can cause impairment or loss of hearing.
- Do not wear radio or music headphones. Safe service and operation requires your full attention.

Stay Clear of Rotating Drivelines



Entanglement in rotating driveline can cause serious injury or death:

- Wear close fitting clothing.
- Stop the engine and be sure PTO driveline is stopped before getting near it.

Practice Safe Maintenance



- Understand service procedure before doing work. Keep area clean and dry.
- Never lubricate, service, or adjust machine while it is moving. Keep safety devices in place and in working condition. Keep hardware tight.
- Keep hands, feet, clothing, jewelry, and long hair away from any moving parts, to prevent them from getting caught.
- Lower attachments to the ground before servicing machine. Disengage all power and stop the engine. Lock park brake and remove the key. Let machine cool.
- Disconnect battery or remove spark plug wire before making any repairs.
- Before servicing the machine, carefully release pressure from any components with stored energy, such as hydraulic components.

SAFETY

- Keep all nuts and bolts tightened, especially blade attachment bolts.
- Securely support any machine elements that must be raised for service work.
- Never run engine unless park brake is locked.
- Keep all parts in good condition and properly installed. Fix damage immediately. Replace worn or broken parts. Replace all worn or damaged safety and instruction decals.
- To prevent fires, remove any buildup of grease, oil, or debris from the machine, especially the engine compartment.
- Charge batteries in an open, well-ventilated area, away from sparks. Unplug battery charger before connecting or disconnecting from the battery. Use insulated tools.
- Do not modify machine or safety devices. Unauthorized modifications may impair its function and safety.
- Do not wear radio or music headphones while servicing the machine. Safe service requires your full attention.

INSTALLING

Installing Mower

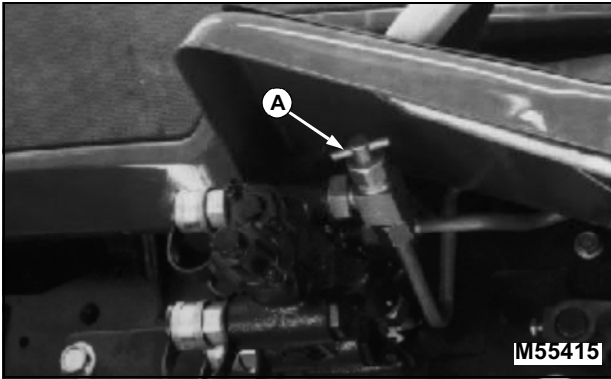

NOTE: Tractors equipped with the optional front hitch or loader are equipped with hydraulic valve (A).

To make the hydraulic control lever function properly for raising and lowering the mower deck, turn T-handle counterclockwise until tight.

1. Stop tractor on a hard level surface, such as a cement floor.
2. Lock the park brake.

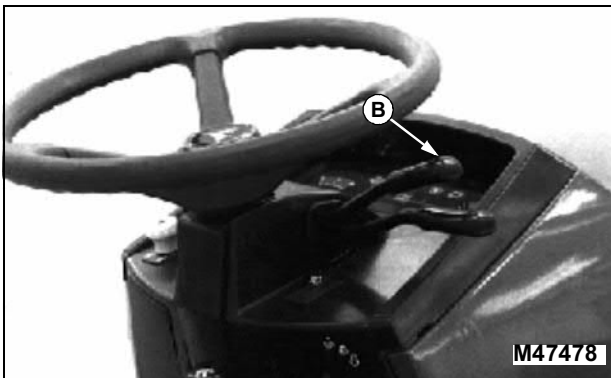

3. Raise mower lift arms as high as they will go by pulling hydraulic lever (B) rearward.
4. Turn front wheels to the left.
5. Adjust the mower deck depth stop to the lowest cut height setting.
6. Stop the engine and wait for all moving parts to stop.

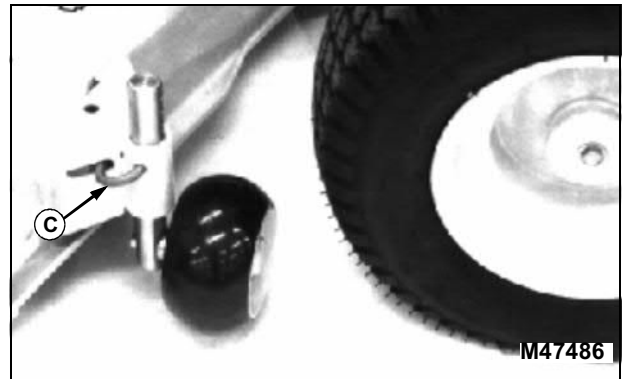

7. Put all gauge wheels in the sideways position:
 - a. Pull spring loaded J-pin (C).
 - b. Turn each wheel 90 degrees.
 - c. Secure wheel with spring loaded J-pin.
8. Roll mower deck under tractor from the right side with PTO driveline pointing toward left side of deck.
9. Push mower deck toward the front tires to aid in driveline installation.

NOTE: Driveline installation is easier if installed from left side of tractor. It may also be necessary to pull on the mower deck drive belt to aid alignment of driveline splines.

You should hear a click when driveline is properly installed on tractor shaft.

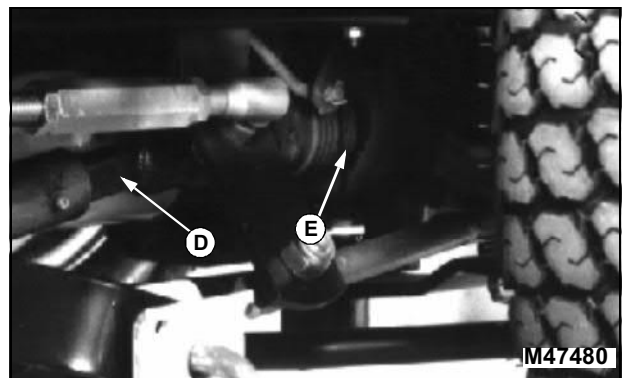

10. Install mower driveline (D) on tractor by pulling collar (E) on coupler back and pushing driveline onto tractor shaft until collar locks in place.
11. Slide mower deck rearward.
12. Lower the tractor lift arms.

INSTALLING

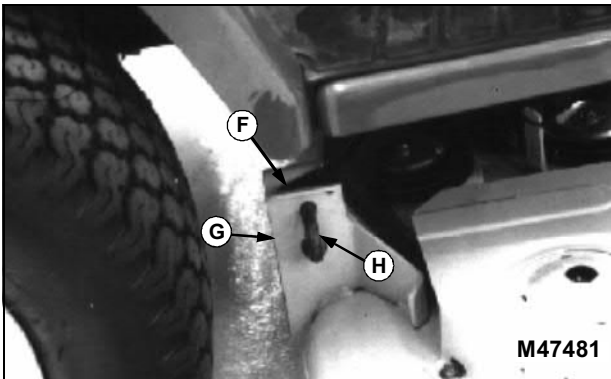

13. Put each tractor rear lift arm (F) between brackets (G) on mower deck.

14. Lock tractor rear lift arm in place with spring loaded J-pin (H).

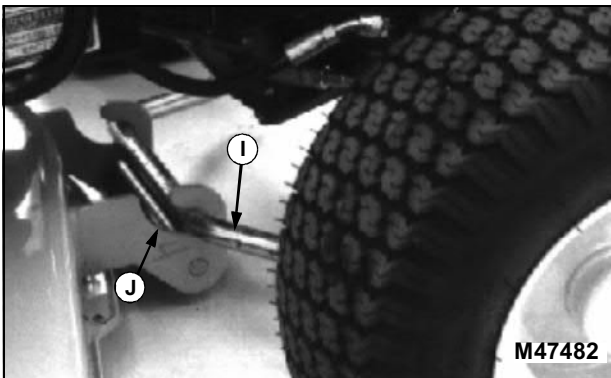

15. Put front draft rod (I) of mower draft assembly in slotted bracket (J) on mower deck.

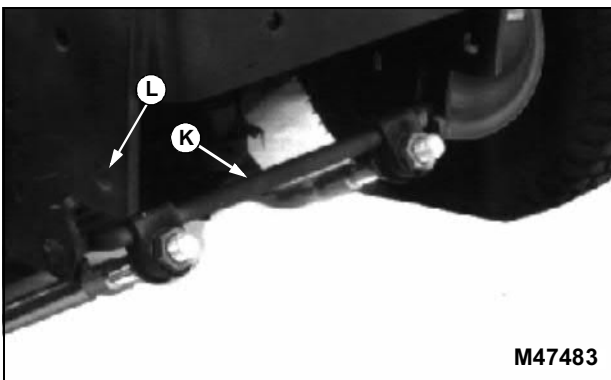

16. Install front draft pivot end (K) of mower draft assembly in slot (L) on each side of tractor frame.

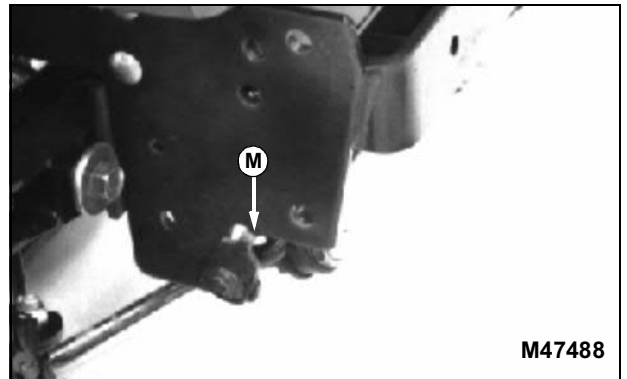

17. Make sure tab (M) is in position shown.

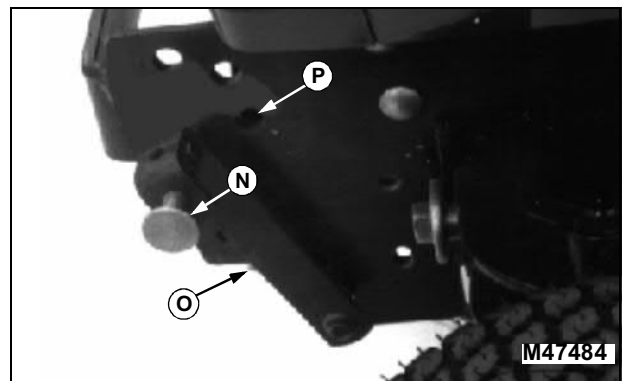

18. Pull spring loaded pin (N) outward of handle (O) and put in hole (P) on tractor frame.

19. Start engine and raise mower deck.

20. Stop the engine.

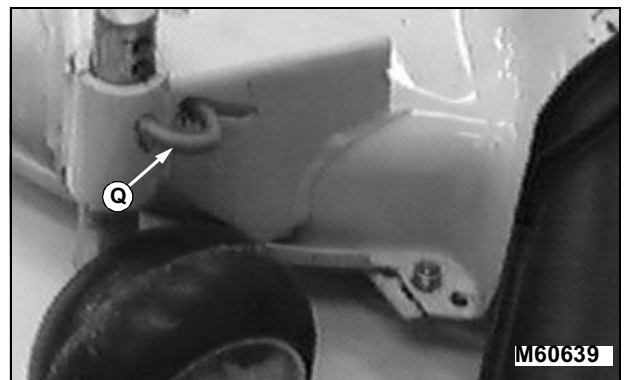

21. Put all four gauge wheels in the mowing position:

- Pull spring loaded J-pin (Q).
- Turn each wheel 90 degrees.
- Choose desired cutting height and insert spring loaded J-pin back into proper hole.

22. Adjust cutting height.



Suggest:

If the above button click is invalid.

Please download this document

first, and then click the above link

to download the complete manual.

Thank you so much for reading

REMOVING

Removing Mower

1. Stop tractor on a hard, level surface, such as a cement floor.
2. Lock the park brake.

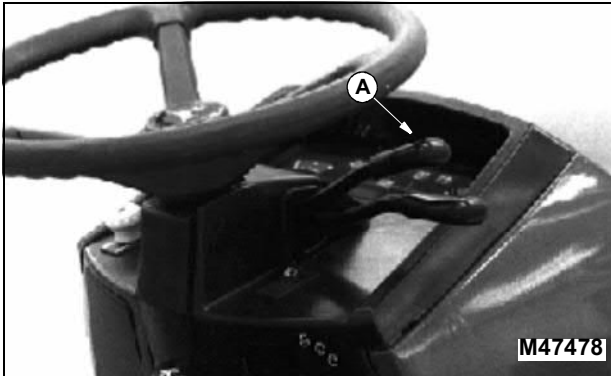

3. Raise mower as high as it will go by pulling hydraulic lever (A) rearward.
4. Adjust the mower deck depth stop to the lowest cut height setting.
5. Turn front wheels to the left.
6. Stop the engine and wait for all moving parts to stop.

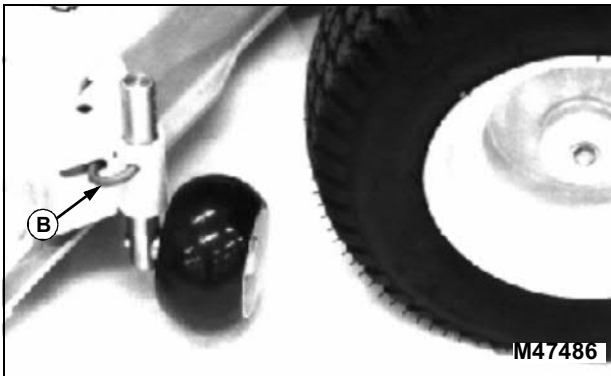

7. Put all gauge wheels in the sideways position:
 - a. Pull spring loaded J-pin (B).
 - b. Turn each wheel 90 degrees.
 - c. Secure wheel with spring loaded J-pin.
8. Lower mower to the ground.

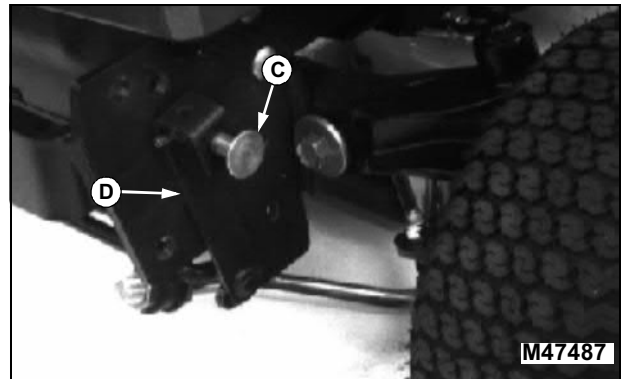

9. Pull spring loaded pin (C) outward and pull handle (D) forward.

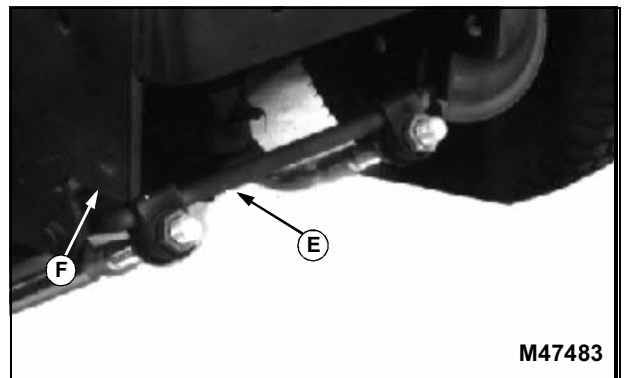

10. Slide mower pivot rod (E) out of slots (F).

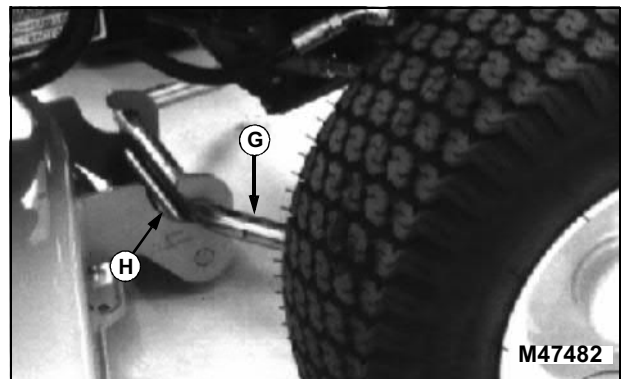

11. Remove front draft rod (G) of mower draft assembly from slotted bracket (H) on mower deck.
12. Remove front draft assembly from underneath tractor.

<https://www.ebooklibonline.com>

Hello dear friend!

Thank you very much for reading.

Enter the link into your browser.

The full manual is available for immediate download.

<https://www.ebooklibonline.com>