

# 25S, 30S and 38B Trimmer/Brush Cutters

(Serial No. 075001 – )



## OPERATOR'S MANUAL

John Deere  
Lawn & Grounds Care Division  
OMM122060 H5

North American Version  
Litho in U.S.A  
English



## TABLE OF CONTENTS

---

---

	Page
<b>Safety Signs</b>	
Safety-Alert Symbol.....	1
Machine Safety Labels .....	1
Read And Understand Operator's And Safety Manuals .....	2
Danger Zone And Kickout.....	3
Blade/Cutting .....	3
<b>Controls</b>	
Engine Controls .....	4
<b>Operating</b>	
Operate Safely .....	5
Adjusting Line Length (25S And 30S).....	6
Adjusting Handle (25S And 30S).....	7
Adjusting Handlebar (38B).....	7
Adjusting/Attaching Body Harness (30S And 38B).....	8
Adjusting/Attaching Body Harness (25S).....	9
Starting Cold Engine.....	11
Starting Warm Engine.....	14
Stopping Engine .....	15
Trimming Tips .....	15
Mowing And Scalping Tips .....	16
Edging And Sweeping Tips.....	17
Blade Cutting Tips .....	18
<b>Service Machine Safely</b>	
Service Trimmer/Brush Cutter Safely .....	19
Wear Appropriate Clothing .....	19
Handling Waste Products .....	19
Filling Fuel Tank Safely .....	20

**<https://www.ebooklibonline.com>**

Hello dear friend!

Thank you very much for reading.

Enter the link into your browser.

The full manual is available for immediate download.

**<https://www.ebooklibonline.com>**

## TABLE OF CONTENTS

---

---

	Page
<b>Service</b>	
Service Intervals.....	21
Extreme Pressure Or Multipurpose Grease .....	21
Engine Oil.....	22
Mixing Fuel.....	22
Filling Fuel Tank.....	24
Checking Gearcase Lubricant.....	24
Cleaning Fuel Filter .....	25
Checking Spark Plug.....	25
Replacing Air Cleaner Element (25S And 30S) .....	26
Replacing Air Cleaner Element (38B) .....	27
Cleaning Cylinder Fins .....	27
Lubricating Driveshaft .....	28
Cleaning Muffler And Exhaust Port (25S And 30S) .....	29
Cleaning Muffler And Exhaust Port (38B) .....	31
Adjusting Carburetor .....	33
Changing Cutting Line (25S And 30S).....	34
Replacing Spool (25S And 30S) .....	35
Replacing Line Cutting Blade (25S And 30S) .....	35
Sharpening Blade.....	36
Sharpening 80-Tooth Steel Saw Blade (38B) .....	36
<b>Optional Equipment</b>	
Sharpening 8-Tooth Plastic Blade.....	37
Sharpening 8-Tooth Steel Weed And Grass Blade.....	37
Sharpening 80-Tooth Steel Saw Blade (25S And 30S) .....	38
<b>Troubleshooting</b>	
Using Troubleshooting Chart .....	39

## TABLE OF CONTENTS

---

---

	Page
<b>Storing Machine</b>	
Storing Trimmer/Brush Cutter .....	40
Storing Or Transporting Blade (38B) .....	41
Removing Trimmer/Brush Cutter From Storage .....	41
<b>Assembly</b>	
Install Drive Shaft Housing (25S And 30S).....	42
Attach Throttle Linkage (25S And 30S) .....	42
Install Handle (25S And 30S) .....	43
Install Shield (25S And 30S).....	43
Install Cutting Head (25S And 30S).....	44
Adjusting/Attaching Body Harness (30S And 38B).....	45
Adjusting/Attaching Body Harness (25S).....	46
Install Drive Shaft Housing (38B).....	47
Install Handlebar Assembly .....	47
Attach Throttle Linkage (38B) .....	48
Install Metal Shield (38B).....	48
Install Blade (38B) .....	49
<b>Specifications</b>	
Engine.....	51
Drive .....	52
<b>Warranty Information</b>	
Product Warranty.....	54

## TABLE OF CONTENTS

---

---

	Page
<b>John Deere Service Literature Available</b>	
Order Form.....	55

All information, illustrations and specifications in this manual are based on the latest information at the time of publication. The right is reserved to make changes at any time without notice.

COPYRIGHT© 1995  
John Deere Horicon Works  
All rights reserved  
Previous Editions  
COPYRIGHT© 1994, 1992, and 1990

# SAFETY SIGNS

## Safety-Alert Symbol

Read and recognize safety information. Be alert to the potential for personal injury when you see this safety-alert symbol.

On your machine safety labels, the words DANGER, WARNING, and CAUTION are used with this safety-alert symbol. DANGER identifies the most serious hazards. In this manual, the word CAUTION and this symbol call attention to safety messages.



## Machine Safety Labels

**WARNING ⚠ DANGER**

The unit can be dangerous and cause serious injury or property loss. In order to use safely, operators, helpers and bystanders, read and understand the Operation and Safety Manual. Accidents can occur from objects that are thrown or reacted even with shield in place. Operators, helpers and bystanders must wear eye protection, ANSI Z87.1 approved.

\*Always wear seating restraint when operating unit.

Prevent accidental contact with unit and any cutting attachment. Maintain a 50 ft. (15m) radius **DANGER ZONE** surrounding the operator. **ONLY** the operator, dressed in proper protective clothing should be in the **DANGER ZONE**.

Be aware of **BACKLASH** blade throw when using narrow Special precaution: see notes on 2nd blade operation. See your Operation and Safety Manual. **ONLY** install approved blades or Bushchutes. Must be equipped with proper blade shields. Use eye, harness, brake collar, ear and water suit.

**\*BUSHCHUTE** machines **DO NOT** stop immediately when running blades. Fully follow and use the Bushchute Machine Safety Sign in place of and cutting attachment to reposition.

**\*INSPECT BLADES BEFORE USE.**

**\*DO NOT USE DAMAGED, CRACKED, BENT, DULL OR IMPROPERLY SHARPENED BLADES.**

\*Do not use worn blades, notify the manufacturer or retailer, approved by approved standards, industry and agencies that Operation and Safety Manuals are available above or by writing.

**Models 25S and 30S**

**M71091**

**Model 38B**

**M71090**

**M60853C**

**⚠ DANGER**

**ROTATION** →

**M71092**

**M60851**

# SAFETY SIGNS

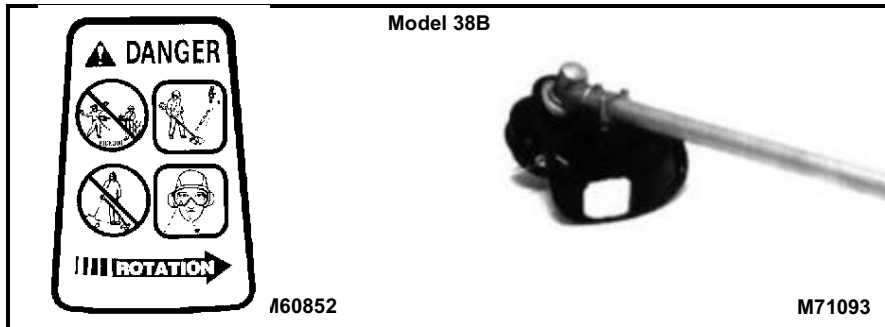

## Read And Understand Operator's And Safety Manuals

This unit can be dangerous and cause serious injury if improperly used. To reduce injury risk to operator, helpers and bystanders, read and understand the operators and Safety Manuals.

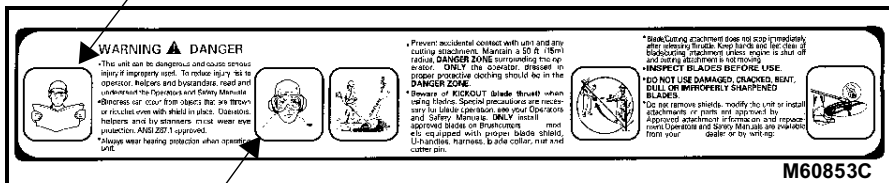

Blindness can occur from objects that are thrown or ricochet even with shield in place. Operators, helpers and by-standers must wear eye protection, ANSI Z87.1 approved.

Always wear hearing protection when operating unit.

# SAFETY SIGNS

## Danger Zone And Kickout

Prevent accidental contact with unit and any cutting attachment. Maintain a 50 ft. (15m) radius, **DANGER ZONE** surrounding the operator. **ONLY** the operator, dressed in proper protective clothing should be in the **DANGER ZONE**.

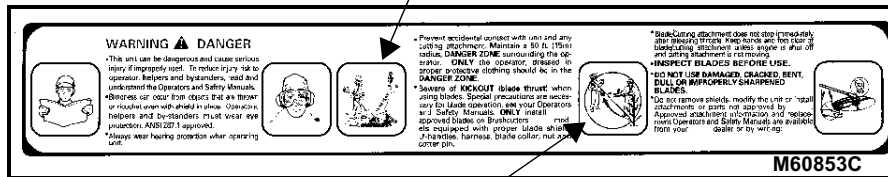

Beware of **KICKOUT (blade thrust)** when using blades. Special precautions are necessary for blade operation, see your Operators and Safety Manuals. **ONLY** install approved blades on Brushcutters (Straight Shaft Units) equipped with proper blade shield, U-handles, harness, blade collar, nut and cotter pin.

## Blade/Cutting

Blade/Cutting attachment does not stop immediately after releasing throttle. Keep hands and feet clear of blade/cutting attachment unless engine is shut off and cutting attachment is not moving.

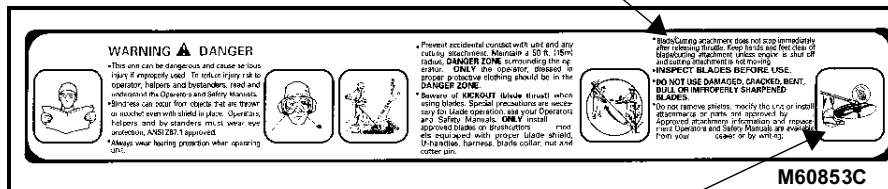

**INSPECT BLADES BEFORE USE.**

**DO NOT USE DAMAGED, CRACKED, BENT, DULL OR IMPROPERLY SHARPENED BLADES.**

Do not remove shields, modify the unit or install attachments or parts not approved by John Deere. Approved attachment information and replacement Operators and Safety Manuals are available from your John Deere dealer.

# CONTROLS

## Engine Controls

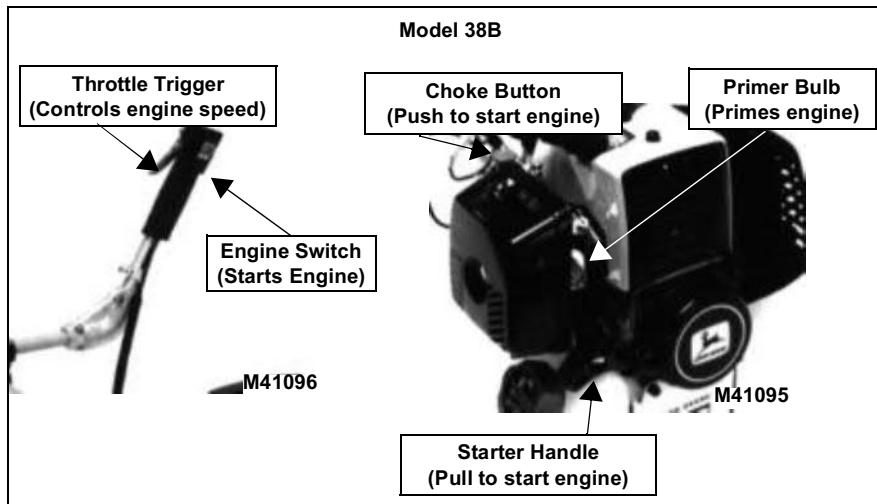
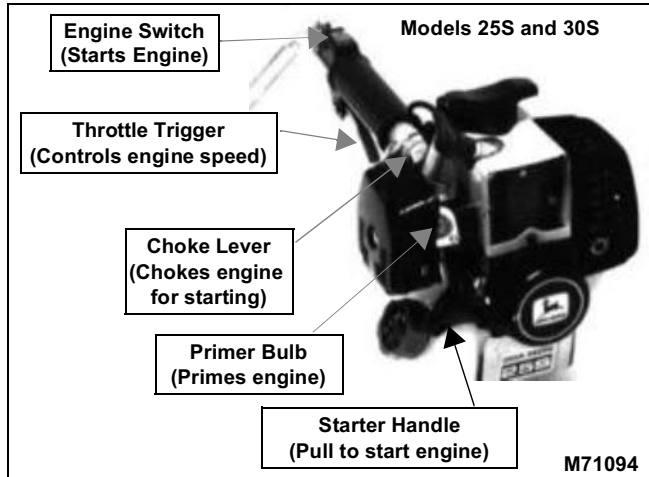

## OPERATING

---

### Operate Safely

- Tighten parts on rotating head before you operate trimmer/brush cutter.
- Wear shoulder harness when you operate trimmer/brush cutter.
- Start trimmer/brush cutter on ground.
- DO NOT run engine in an enclosed area.
- DO NOT use trimmer/brush cutter when you are tired.
- Keep hand grips clean and dry.
- Hold trimmer/brush cutter firmly with both hands.
- Keep solid footing.
- Cut at ground level only.
- Wear goggles or safety glasses when you cut or trim.
- Trim from left to right so trimmer throws particles away from you. Cut with head tilted to the right. DO NOT draw trimmer/brush cutter head toward you.
- DO NOT reach to make a cut.
- STOP engine before you remove debris from cutting head.
- DO NOT operate trimmer/brush cutter without shield. Use metal shield when you are brush cutting with a blade.
- Use U-handlebars when you are brush cutting with a blade.
- DO NOT edge with metal blade.
- Use proper blade for cutting job to avoid kickout.
- Keep people and pets at least 15M (50 FT) away.
- Do not leave trimmer/brush cutter unattended.

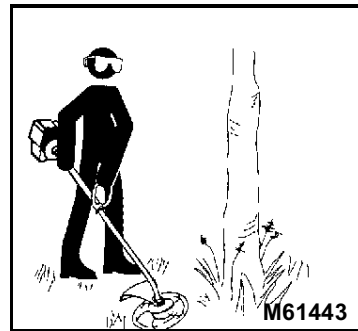
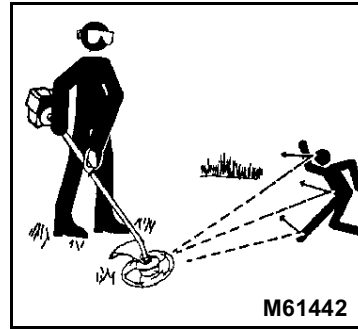

# OPERATING

## Operate Safely (Continued)

- Do not hand trimmer/brush cutter to another person while engine is running.
- Do not let anyone operate trimmer/brush cutter without proper instruction.
- Do not let CHILDREN operate trimmer/brush cutter.

## Wear Appropriate Clothing

- Wear close fitting clothing and safety equipment appropriate for the job.
- Loud noise can cause impairment or loss of hearing, wear a suitable protective device such as earplugs.
- Do not wear radio or music headphones while operating the machine. Safe operation requires your full attention.



## Adjusting Line Length (25S And 30S)

**IMPORTANT:** Keep line cutting length 127–152 mm (5–6 in):

- Line too long will overload engine.
- Line too short may cause engine to overspeed.

If line is 50 mm (2 in.) or less you must lengthen it manually:

- Push and hold button (A).
- Pull line(s) to desired length.

To adjust line(s) during operation:

- Run engine at full throttle.
- Firmly tap button (A) on hard surface, not on lawn. Line extends 25 mm (1 in.) with each tap.

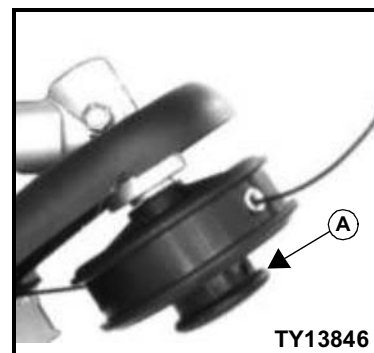

## OPERATING

### Adjusting Handle (25S And 30S)

**C CAUTION:** Do not put handle assembly over caution decal.

1. Loosen screws (A).

**NOTE: Cutter head should balance 25–51 mm (1–2 in.) above ground when attached to harness.**

2. Put handle assembly in desired position.

3. Tighten screws.

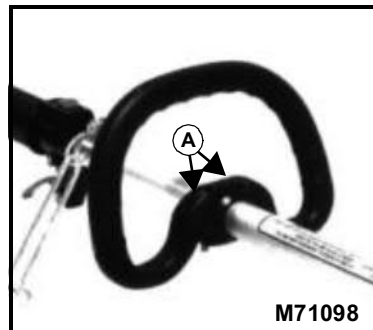

### Adjusting Handlebar (38B)

**C CAUTION:** Do not put handlebar bracket over caution decal.

**NOTE: Cutter head should balance 25–51 mm (1–2 in.) above ground when attached to harness.**

To adjust left handlebar:

- Loosen four screws (A).
- Move handlebar(s) to desired position.
- Tighten screws.

To adjust right handlebar:

- Loosen four screws (C).
- Move handlebar(s) to desired position.
- Tighten screws.

To adjust handlebar position on shaft:

- Loosen four screws (B).
- Move handlebar bracket to desired position.
- Tighten screws.

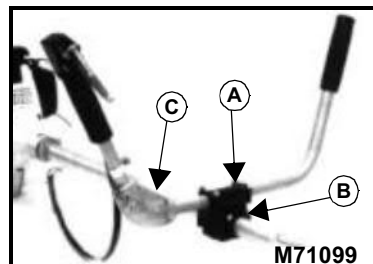

## OPERATING

### Adjusting/Attaching Body Harness (30S And 38B)

**IMPORTANT:** Make harness adjustments before you attach trimmer/brush cutter.

1. Adjust shoulder and waist straps so hook (A) is at waist height.
2. Put shoulder pad (if equipped) on shoulder.
3. Fasten waist belt.

**IMPORTANT:** Start trimmer/brush cutter on the ground before you attach it to harness.

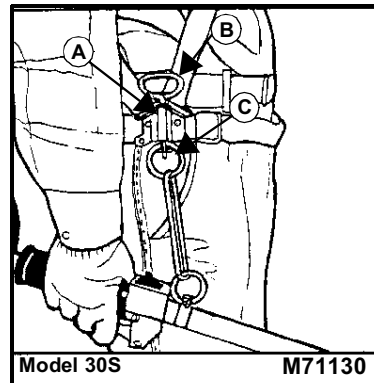

4. Pull up pin (B) and LOCK in trimmer/brush cutter ring-hook (C).

**NOTE:** Cutter head should balance 25–51 mm (1–2 in.) above ground when attached to harness.

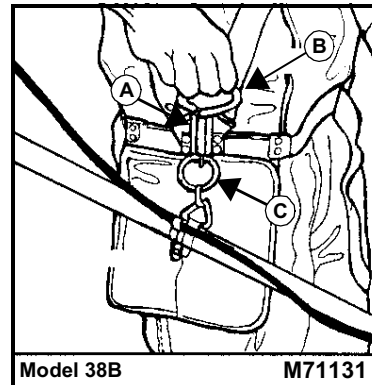

## OPERATING

5. Loosen nut(s) (D) on ring-hook assembly.

6. Slide bracket up or down until blade tip or line head is balanced 25–51 mm (1–2 in.) above ground. Tighten nut.

7. Move handle or handlebar to desired position. (See Adjusting Handle–25S and 30S Or Adjusting Handlebar–38B in this section.)

8. Remove trimmer/brush cutter from harness when you finish adjustments.

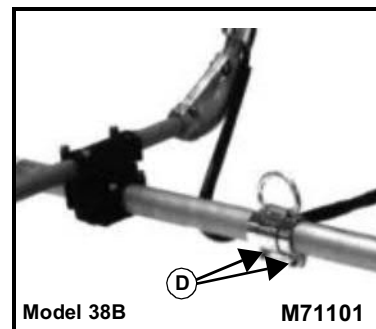
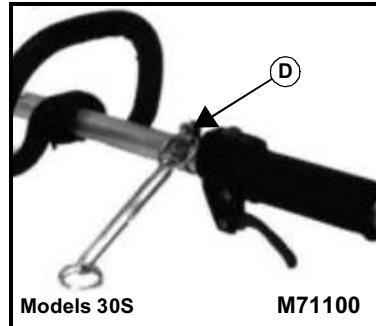

### Adjusting/Attaching Body Harness (25S)

**IMPORTANT:** Make harness adjustments before you attach trimmer/brush cutter.

1. Adjust shoulder and waist straps so ring (A) is at waist height.

2. Put shoulder pad (if equipped) on shoulder.

3. Fasten waist belt.

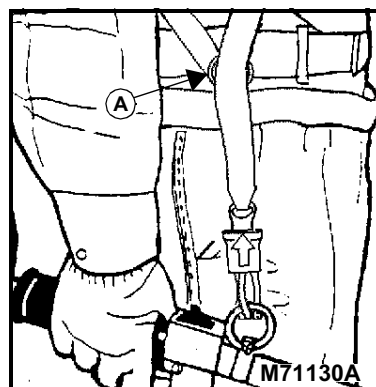

## OPERATING

**IMPORTANT:** Start trimmer/brush cutter on the ground before you attach it to harness.

4. Pull spring lock (B) up.

5. Put ring hook (C) (located on string trimmer) on bottom portion of spring lock.

6. Release spring lock (B) to lock trimmer/brush cutter in place.

**NOTE: Cutter head should balance 25–51 mm (1–2 in.) above ground when attached to harness.**

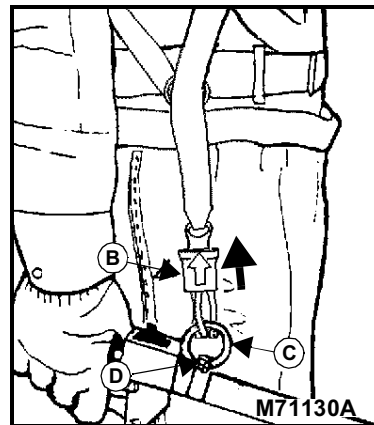

7. Loosen nut (D) on ring-hook assembly.

8. Slide bracket up or down until blade tip or line head is balanced 25–51 mm (1–2 in.) above ground. Tighten nut.

9. Move handle or handlebar to desired position. (See Adjusting Handle–25S and 30S Or Adjusting Handlebar–38B in this section.)

10. Remove trimmer/brush cutter from harness when you finish adjustments.

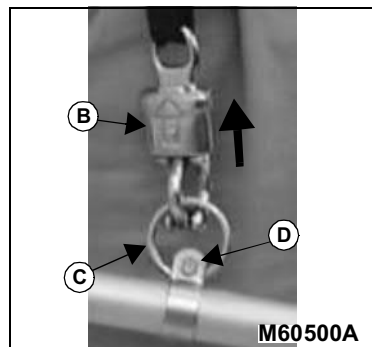



**Suggest:**

**If the above button click is invalid.**

**Please download this document**

**first, and then click the above link**

**to download the complete manual.**

**Thank you so much for reading**

# OPERATING

---

---

## Starting Cold Engine

- C CAUTION:** Avoid inhaling exhaust fumes:
- DO NOT operate trimmer/brush cutter indoors.
  - Start trimmer/brush cutter on ground.

1. Put trimmer/brush cutter on clear, level ground.
2. Support trimmer/brush cutter with shield and engine.

**IMPORTANT:** DO NOT start trimmer/brush cutter in tall grass or brush.

### 3. CHOKE engine:

- On 25S and 30S move choke lever (A) to CLOSED position.

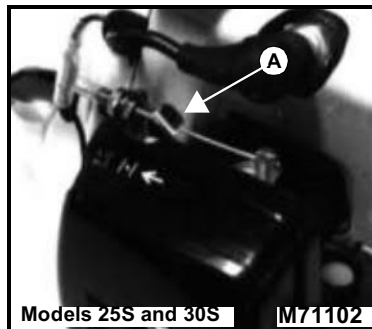

- On Model 38B pull button (B) up for CLOSED position.

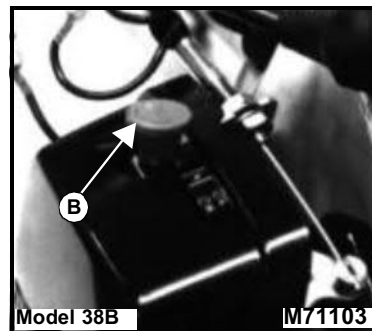

**<https://www.ebooklibonline.com>**

Hello dear friend!

Thank you very much for reading.

Enter the link into your browser.

The full manual is available for immediate download.

**<https://www.ebooklibonline.com>**