

JOHN DEERE
AG & TURF DIVISION

2-Bag Bagger
For 42-Inch and 48-Inch Mower Decks

OMM168257 F2

OPERATOR'S MANUAL



JOHN DEERE

Original Instruction

All information, illustrations and specifications in this manual are based on the latest information at the time of publication. The right is reserved to make changes at any time without notice.

COPYRIGHT© 2012

Deere & Co.

**John Deere Worldwide Commercial and
Consumer Equipment Division**

All rights reserved

Previous Editions

COPYRIGHT©

Export Version

Litho in U.S.A.

INTRODUCTION

Table of Contents

Introduction.....	1
Product Identification.....	1
Safety Labels.....	2
Safety.....	4
Assembly - Identify Parts.....	5
Assembly.....	7
Installing.....	8
Operating.....	11
Service.....	11
Troubleshooting.....	12
Getting Quality Service.....	12

Introduction

Using Your Operator's Manual

Read this entire operator's manual, especially the safety information, before operating.

This manual is an important part of your machine. Keep all manuals in a convenient location so they can be accessed easily.

Use the safety and operating information in the attachment operator's manual, along with the machine operator's manual, to operate and service the attachment safely and correctly.

If your attachment manual has a section called Preparing the Machine, it means that you will have to do something to your tractor or vehicle before you can install the attachment. The Assembly and Installation sections of this manual provide information to assemble and install the attachment to your tractor or vehicle. Use the Service section to make any needed adjustments and routine service to your attachment.

If you have any questions or concerns with the assembly, installation, or operation of this attachment, see your local John Deere dealer or call the John Deere Customer Contact Center at 1-800-537-8233 for assistance.

Warranty information on this John Deere attachment can be found in the warranty that came with your John Deere tractor or vehicle.

Product Identification

Product Compatibility

The 42 in. and 48 in. 2-bag baggers are compatible with Model year 2009 and newer LA100 and D100 Series Lawn Tractors.

Record Purchase Information

Record your purchase information in the spaces provided below.

DATE OF PURCHASE:

DEALER NAME:

DEALER PHONE:

SAFETY LABELS

Safety Labels



Understanding The Machine Safety Labels

The machine safety labels shown in this section are placed in important areas on your machine to draw attention to potential safety hazards.

On your machine safety labels, the words DANGER, WARNING, and CAUTION are used with this safety-alert symbol. DANGER identifies the most serious hazards.

The operator's manual also explains any potential safety hazards whenever necessary in special safety messages that are identified with the word, CAUTION, and the safety-alert symbol.

WARNING

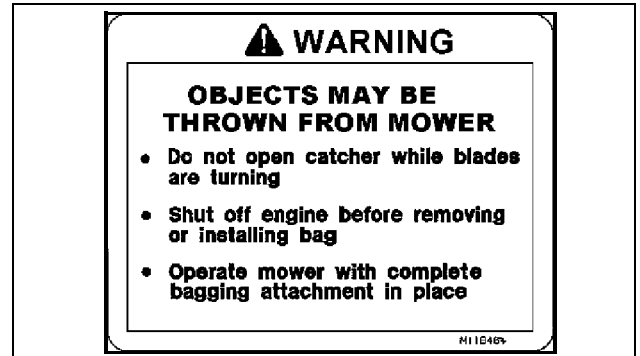

M118464

Objects May Be Thrown from Mower

- Do not open catcher while blades are turning.
- Shut off engine before removing or installing bag.
- Operate mower with complete bagging attachment in place.

WARNING

Thrown Objects



M118223

- Do not operate mower without chutes and hoses securely in place.

CAUTION

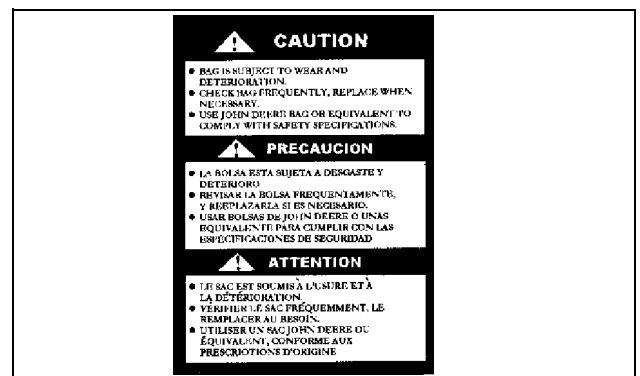

GC00215

- Bag is subject to wear and deterioration.
- Check bag frequently and replace when necessary.
- Use John Deere bag or equivalent to comply with safety specifications.

<https://www.ebooklibonline.com>

Hello dear friend!

Thank you very much for reading.

Enter the link into your browser.

The full manual is available for immediate download.

<https://www.ebooklibonline.com>

SAFETY LABELS

M122118 Warning

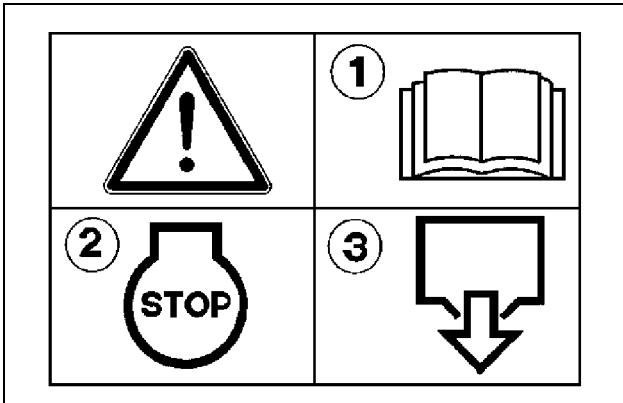

M122118

- Read operator's manual.
 - The operator's manual contains important information necessary for safe machine operation. Observe all safety rules to avoid accidents.
- Shut off mower before emptying grass bag.
- Bag is subject to wear and deterioration. Check bag frequently; replace when necessary.
- Use a John Deere bag or equivalent to comply with safety specifications.

M122119 Warning

Avoid Injury From Tipping

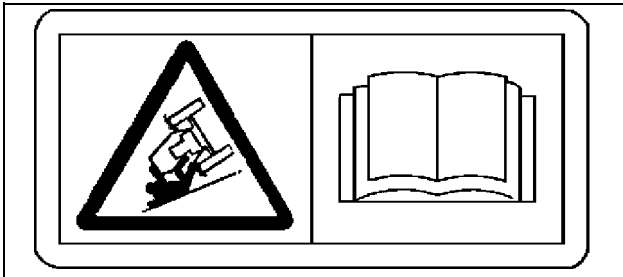

M122119

- Do not drive where machine could slip or tip.
- See operator's manual for required ballast to maintain steering control and stability.

M129037 Warning

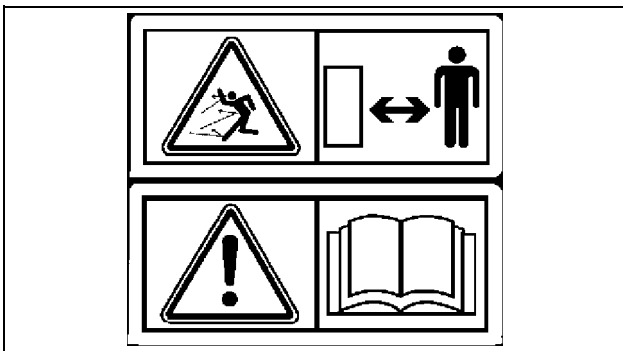

M129037

Avoid Injury From Thrown Objects

- Operator mower with complete bagging attachments in place.
- Do not open catcher while blades are turning.
- Shut off engine before removing or installing bag
- Keep bystanders away while engine is running.

Read Operator's Manual

- The operator's manual contains important information necessary for safe machine operation. Observe all safety rules to avoid accidents.

M149489 Warning



M149489

- Do not put hands or feet under or into mower when engine is running.
- Keep away from rotating parts. Do not open or remove safety shields while engine is running. Operate blower with entire grass catcher secured in place.
- Thrown Objects - Before mowing, clear area of objects that may be thrown by blade. Do not operate mower without discharge chute or entire grass catcher in place.
- Stay a safe distance from machine.
- Read operator's manual.

SAFETY

Safety

Read Safety in Machine Operator's Manual

Read the general safety operating precautions in your machine operator's manual for additional safety information.

Operating Safely

Read, understand and follow all instructions in this attachment manual, the machine operator's manual and safety signs on equipment before starting.

Use proper front ballast. Remove ballast when the material collection system is removed.

Hopper extends beyond machine. Be aware of surrounding objects when making short turns.

Do not operate material collection system unless entire grass catcher is fastened in place with hopper cover securely latched.

Do not let anyone ride on the mower or material collection system. Riders are subject to injury such as being struck by foreign objects or being thrown off. Riders may obstruct the operator's view and cause a collision.

Before bag removal or installation:

- Stop mower.
- Disengage mower or PTO.
- Stop engine and remove key.
- Wait for engine and all moving parts to stop before leaving the operator seat.

Before backing up machine:

- Stop machine.
- Look behind hopper for children.
- Keep bystanders away when unloading material collection system.

Operate safely on slopes:

- Empty bags when they are half full.
- Do not operate on steep slopes.
- Before turning, slow down.
- Avoid sudden starts and stops.
- Do not park machine with material collection system on slopes.

Bag and Hose Maintenance:

- Bag and hose are subject to wear and deterioration.
- Check bag and hose frequently; replace when necessary.
- Use John Deere bag and hose or equivalent to comply with safety specifications.
- Do not leave clippings in bags overnight.

Parking Safely

1. Stop machine on a level surface, not on a slope.
2. Disengage mower blades or any other attachments.
3. Lower attachments to the ground.
4. Lock the park brake.
5. Stop the engine.
6. Remove the key.
7. Wait for engine and all moving parts to stop before you leave the

operator's seat.

8. Close fuel shut-off valve, if your machine is equipped.

9. Disconnect the negative battery cable or remove the spark plug wire(s) (for gasoline engines) before servicing the machine.

Protect Children

- Tragic accidents can occur if the operator is not alert to the presence of children. Keep children indoors when the machine and attachment are operated and under the watchful care of another responsible adult.
- Never assume that children will remain where you last saw them. Stay alert to the presence of children. Turn the machine off if a child enters the work area.
- Do not let children or an untrained person operate the machine.
- Do not carry or let children ride on any attachment or machine even with the attachment off. Do not tow children in a cart or trailer.

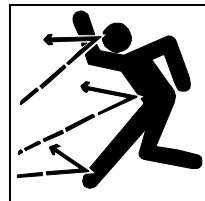

Avoid Injury From Thrown Objects

- When operating the vehicle with the MCS attachment installed make sure all chutes and hoses are securely in place. Keep hopper closed or MCS in operating position.
- Stop the engine and wait for all moving parts to stop before removing or lifting any attachment components.

- Avoid injury from impeller blades and thrown objects. Remove attachment when operating vehicle in side discharge mode. Make sure deflector shield is in place on mower deck if attachment is removed.



Avoid Injury From Rotating Blades

- Keep hands and feet away from rotating blades and blower assembly when engine is running.

- Stop engine and wait for moving parts to stop before servicing components.
- Do not operate MCS or blower unless all attachment components are in place and latched.

Practice Safe Maintenance

- Only qualified, trained adults should service this machine.
- Understand service procedure before doing work. Keep area clean and dry.
- Do not operate the engine in a confined space where dangerous carbon monoxide fumes can collect.
- Never lubricate, service or adjust the machine or attachment while it is moving. Keep safety devices in place and in working condition. Keep hardware tight.
- Keep hands, feet, clothing, jewelry, and long hair away from any moving parts, to prevent them from getting caught.
- Lower any attachment completely to the ground or to an existing attachment mechanical stop before servicing the attachment. Disengage all power and stop the engine. Lock park brake and remove the key. Let machine cool.
- Disconnect battery or remove spark plug wire (for gasoline engines) before making any repairs.
- Before servicing machine or attachment, carefully release pressure from any components with stored energy, such as hydraulic components and

ASSEMBLY - IDENTIFY PARTS

springs.

- Release hydraulic pressure by lowering attachment or cutting units to the ground or to a mechanical stop and move hydraulic control levers.
- Securely support any machine or attachment elements that must be raised for service work. Use jack stands or lock service latches to support components when needed.
- Never run engine unless park brake is locked.
- Keep all parts in good condition and properly installed. Fix damage immediately. Replace worn or broken parts. Replace all worn or damaged safety and instruction decals.

- Check all hardware at frequent intervals to be sure the equipment is in safe working condition.
- Do not modify machine or safety devices. Unauthorized modifications to the machine or attachment may impair its function and safety.

Assembly - Identify Parts

Bagger and Hopper Parts

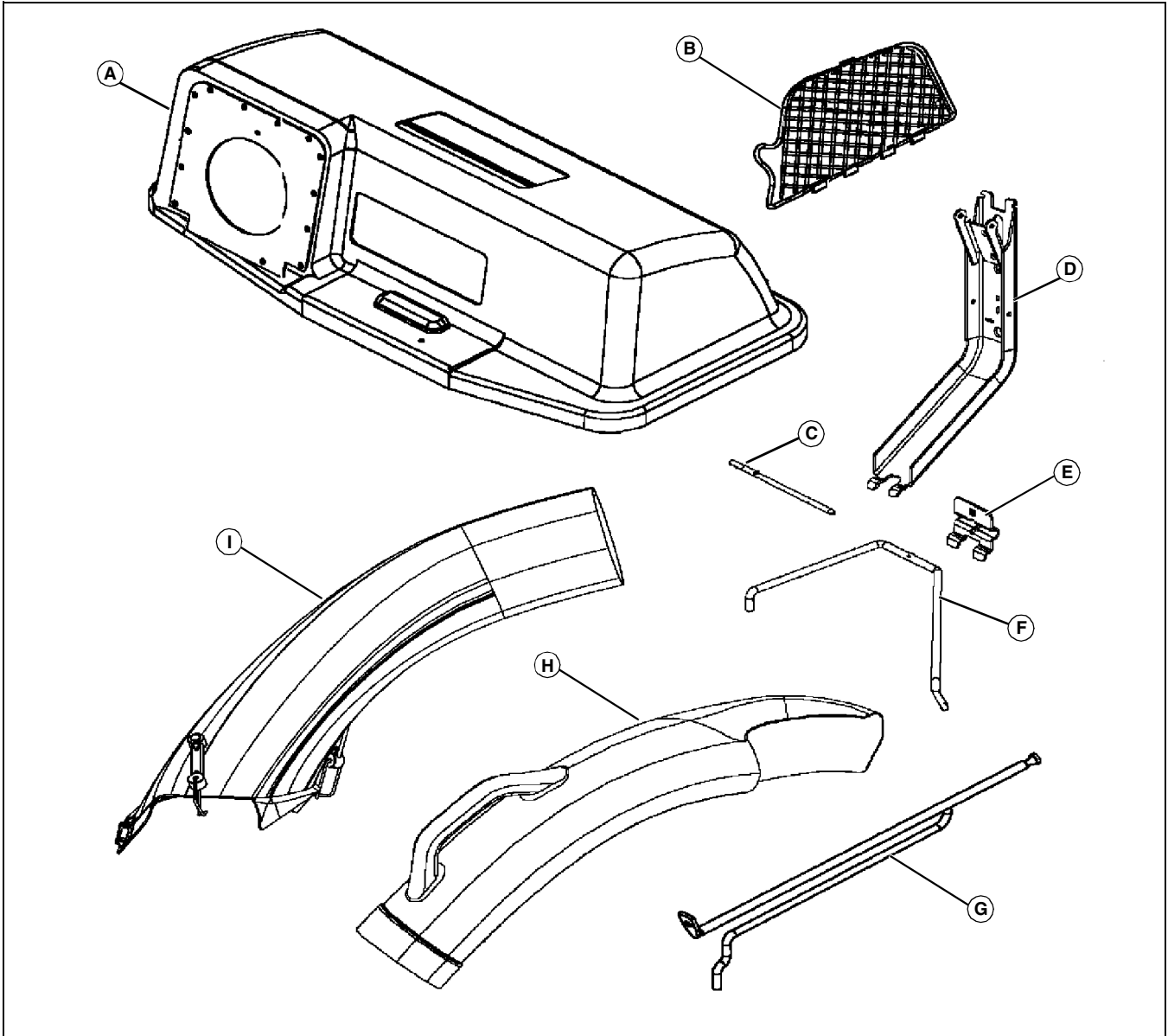

MX41736

Key	Description	Qty	Key	Description	Qty
A	Hopper Top	1	G	Latch Support Rod	1
B	Hopper Screen	1	H	Upper Discharge Chute	1
C	Drilled Pin (In bag of parts)	1	I	Lower Discharge Chute (42 in. shown)	1



Suggest:

If the above button click is invalid.

Please download this document

first, and then click the above link

to download the complete manual.

Thank you so much for reading

ASSEMBLY - IDENTIFY PARTS

Key	Description	Qty	Key	Description	Qty
D	Mounting Post	1		Grass Bags (Right and Left) (Not Shown)	2
E	Cargo Mount Bracket (In bag of parts)	1		Tie Strap (In bag of parts) (Not Shown)	3
F	Bagger Support Rod	1			

<https://www.ebooklibonline.com>

Hello dear friend!

Thank you very much for reading.

Enter the link into your browser.

The full manual is available for immediate download.

<https://www.ebooklibonline.com>