

**JOHN DEERE**  
**WORLDWIDE COMMERCIAL & CONSUMER**  
**EQUIPMENT DIVISION**

---

**Z-TRAK®**  
**F620, F680, and F687**  
TM1678 JUN02

**TECHNICAL MANUAL**



**JOHN DEERE**



MX5946

This technical manual is written for an experienced technician and contains sections that are specifically for this product. It is a part of a total product support program.

The manual is organized so that all the information on a particular system is kept together. The order of grouping is as follows:

- Table of Contents
- Specifications
- Component Location
- System Schematic
- Theory of Operation
- Troubleshooting Chart
- Diagnostics
- Tests and Adjustments
- Repair

*Note: Depending on the particular section or system being covered, not all of the above groups may be used.*

Each section will be identified with a symbol rather than a number. The groups and pages within a section will be consecutively numbered.

All information, illustrations and specifications in this manual are based on the latest information available at the time of publication. The right is reserved to make changes at any time without notice.

We appreciate your input on this manual. To help, there are postage paid postcards included at the back. If you find any errors or want to comment on the layout of the manual please fill out one of the cards and mail it back to us.

**Safety** 

**Specifications and Information** 

**Engine** 

**Electrical** 

**Hydrostatic Power Train** 

**Brakes** 

**Attachments** 

**Miscellaneous** 

COPYRIGHT© 2002  
 JOHN DEERE WORLDWIDE COMMERCIAL AND  
 CONSUMER EQUIPMENT DIVISION  
 Horicon, Wisconsin  
 All rights reserved

**<https://www.ebooklibonline.com>**

Hello dear friend!

Thank you very much for reading.

Enter the link into your browser.

The full manual is available for immediate download.

**<https://www.ebooklibonline.com>**



**SAFETY**

**RECOGNIZE SAFETY INFORMATION**



This is the safety-alert symbol. When you see this symbol on your machine or in this manual, be alert to the potential for personal injury.

Follow recommended precautions and safe servicing practices.

**Understand Signal Words**

A signal word—DANGER, WARNING, or CAUTION—is used with the safety-alert symbol. DANGER identifies the most serious hazards.

DANGER or WARNING safety signs are located near specific hazards. General precautions are listed on CAUTION safety signs. CAUTION also calls attention to safety messages in this manual.

**REPLACE SAFETY SIGNS**

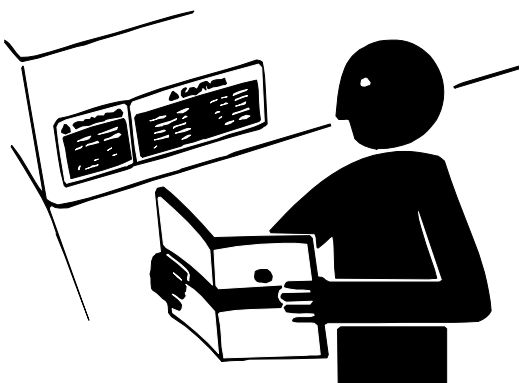

Replace missing or damaged safety signs. See the machine operator's manual for correct safety sign placement.

**HANDLE FLUIDS SAFELY—AVOID FIRES**

**Be Prepared for Emergencies**

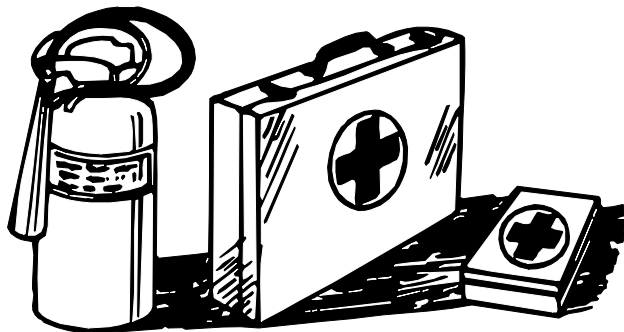

When you work around fuel, do not smoke or work near heaters or other fire hazards.

Store flammable fluids away from fire hazards. Do not incinerate or puncture pressurized containers.

Make sure machine is clean of trash, grease, and debris.

Do not store oily rags; they can ignite and burn spontaneously.

Be prepared if a fire starts.

Keep a first aid kit and fire extinguisher handy.

Keep emergency numbers for doctors, ambulance service, hospital, and fire department near your telephone.

## USE CARE IN HANDLING AND SERVICING BATTERIES

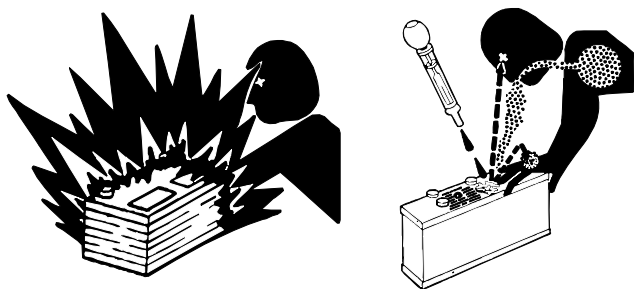

### Prevent Battery Explosions

- Keep sparks, lighted matches, and open flame away from the top of battery. Battery gas can explode.
- Never check battery charge by placing a metal object across the posts. Use a voltmeter or hydrometer.
- Do not charge a frozen battery; it may explode. Warm battery to 16°C (60°F).

### Prevent Acid Burns

- Sulfuric acid in battery electrolyte is poisonous. It is strong enough to burn skin, eat holes in clothing, and cause blindness if splashed into eyes.
- **Avoid acid burns by:**
  1. Filling batteries in a well-ventilated area.
  2. Wearing eye protection and rubber gloves.
  3. Avoiding breathing fumes when electrolyte is added.
  4. Avoiding spilling or dripping electrolyte.
  5. Using proper jump start procedure.
- **If you spill acid on yourself:**
  1. Flush your skin with water.
  2. Apply baking soda or lime to help neutralize the acid.
  3. Flush your eyes with water for 10—15 minutes.
  4. Get medical attention immediately.
- **If acid is swallowed:**
  1. Drink large amounts of water or milk.
  2. Then drink milk of magnesia, beaten eggs, or vegetable oil.
  3. Get medical attention immediately.

## USE CARE AROUND HIGH-PRESSURE FLUID LINES



### Avoid High-Pressure Fluids

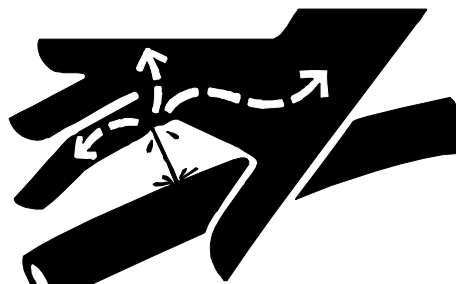

Escaping fluid under pressure can penetrate the skin causing serious injury. Avoid the hazard by relieving pressure before disconnecting hydraulic or other lines. Tighten all connections before applying pressure. Search for leaks with a piece of cardboard. Protect hands and body from high-pressure fluids.

If an accident occurs, see a doctor immediately. Any fluid injected into the skin must be surgically removed within a few hours or gangrene may result. Doctors unfamiliar with this type of injury should reference a knowledgeable medical source. Such information is available from Deere & Company Medical Department in Moline, Illinois, U.S.A. Information may be obtained in the United States and Canada only by calling 1-800-822-8262.

### Avoid Heating Near Pressurized Fluid Lines



Flammable spray can be generated by heating near pressurized fluid lines, resulting in severe burns to yourself and bystanders. Do not heat by welding, soldering, or using a torch near pressurized fluid lines or other flammable materials. Pressurized lines can be accidentally cut when heat goes beyond the immediate flame area.



## USE SAFE SERVICE PROCEDURES

### Wear Protective Clothing

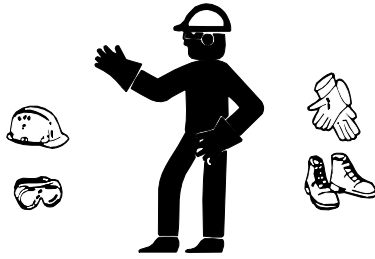

Wear close fitting clothing and safety equipment appropriate to the job.

Prolonged exposure to loud noise can cause impairment or loss of hearing. Wear a suitable hearing protective device such as earmuffs or earplugs to protect against objectionable or uncomfortable loud noises.

Operating equipment safely requires the full attention of the operator. Do not wear radio or music headphones while operating machine.

### Service Machines Safely

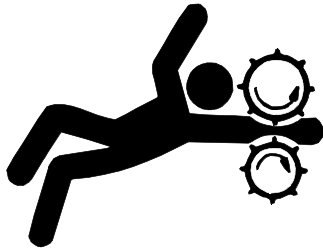

Tie long hair behind your head. Do not wear a necktie, scarf, loose clothing, or necklace when you work near machine tools or moving parts. If these items were to get caught, severe injury could result.

Remove rings and other jewelry to prevent electrical shorts and entanglement in moving parts.

### Use Proper Tools

Use tools appropriate to the work. Makeshift tools and procedures can create safety hazards. Use power tools only to loosen threaded parts and fasteners. For loosening and tightening hardware, use the correct size tools. **DO NOT** use U.S. measurement tools on metric fasteners. Avoid bodily injury caused by slipping wrenches. Use only service parts meeting John Deere specifications.

### Park Machine Safely

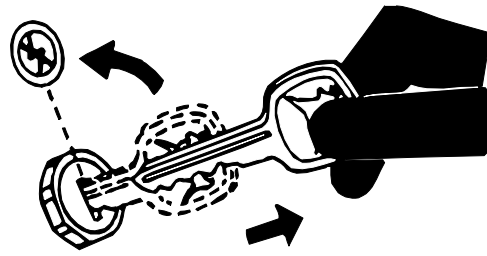

#### Before working on the machine:

1. Lower all equipment to the ground.
2. Stop the engine and remove the key.
3. Disconnect the battery ground strap.
4. Hang a "DO NOT OPERATE" tag in operator station.

### Support Machine Properly and Use Proper Lifting Equipment

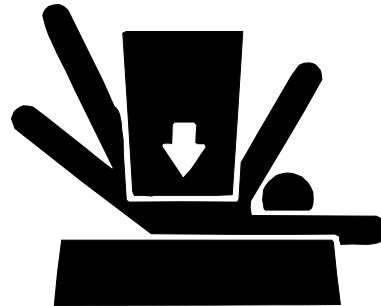

If you must work on a lifted machine or attachment, securely support the machine or attachment.

Do not support the machine on cinder blocks, hollow tiles, or props that may crumble under continuous load. Do not work under a machine that is supported solely by a jack. Follow recommended procedures in this manual.

Lifting heavy components incorrectly can cause severe injury or machine damage. Follow recommended procedure for removal and installation of components in the manual.

### Work in Clean Area

#### Before starting a job:

1. Clean work area and machine.
2. Make sure you have all necessary tools to do your job.
3. Have the right parts on hand.
4. Read all instructions thoroughly; do not attempt shortcuts.

## Using High-Pressure Washers

Directing pressurized water at electronic/electrical components or connectors, bearings, hydraulic seals, fuel injection pumps or other sensitive parts and components may cause product malfunctions. Reduce pressure and spray at a 45 to 90 degree angle.

## Illuminate Work Area Safely

Illuminate your work area adequately but safely. Use a portable safety light for working inside or under the machine. Make sure the bulb is enclosed by a wire cage. The hot filament of an accidentally broken bulb can ignite spilled fuel or oil.

## Work in Ventilated Area

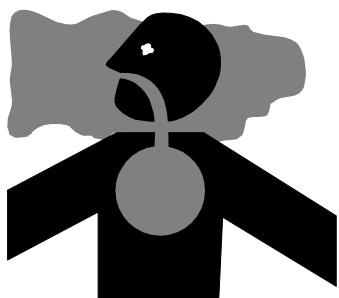

Engine exhaust fumes can cause sickness or death. If it is necessary to run an engine in an enclosed area, remove the exhaust fumes from the area with an exhaust pipe extension.

If you do not have an exhaust pipe extension, open the doors and get outside air into the area.

## WARNING: California Proposition 65 Warning

Diesel engine exhaust and some of its constituents are known to the State of California to cause cancer, birth defects, and other reproductive harm.

Gasoline engine exhaust from this product contains chemicals known to the State of California to cause cancer, birth defects, or other reproductive harm.

## Remove Paint Before Welding or Heating

Avoid potentially toxic fumes and dust. Hazardous fumes can be generated when paint is heated by welding, soldering, or using a torch. Do all work outside or in a well-ventilated area. Dispose of paint and solvent properly. Remove paint before welding or heating. If you sand or grind paint, avoid breathing the dust. Wear an approved respirator. If you use solvent or paint stripper, remove stripper with soap and water before welding. Remove solvent or paint stripper containers and other flammable material from area. Allow fumes to disperse

at least 15 minutes before welding or heating.

## Avoid Harmful Asbestos Dust

Avoid breathing dust that may be generated when handling components containing asbestos fibers. Inhaled asbestos fibers may cause lung cancer.

Components in products that may contain asbestos fibers are brake pads, brake band and lining assemblies, clutch plates, and some gaskets. The asbestos used in these components is usually found in a resin or sealed in some way. Normal handling is not hazardous as long as airborne dust containing asbestos is not generated.

Avoid creating dust. Never use compressed air for cleaning. Avoid brushing or grinding material containing asbestos. When servicing, wear an approved respirator. A special vacuum cleaner is recommended to clean asbestos. If not available, apply a mist of oil or water on the material containing asbestos. Keep bystanders away from the area.

## SERVICE TIRES SAFELY



Explosive separation of a tire and rim parts can cause serious injury or death.

Do not attempt to mount a tire unless you have the proper equipment and experience to perform the job. Always maintain the correct tire pressure. Do not inflate the tires above the recommended pressure. Never weld or heat a wheel and tire assembly. The heat can cause an increase in air pressure resulting in a tire explosion. Welding can structurally weaken or deform the wheel.

When inflating tires, use a clip-on chuck and extension hose long enough to allow you to stand to one side and NOT in front of or over the tire assembly. Use a safety cage if available.

Check wheels for low pressure, cuts, bubbles, damaged rims or missing lug bolts and nuts.

## CHECKS, TESTS AND ADJUSTMENTS

### NEUTRAL (ZERO CREEP) CHECK AND ADJUSTMENT

#### Reason:

To ensure that the machine does not move when the control levers are in the NEUTRAL position, while the engine is running.

#### Check Procedure:

## CAUTION

Engine exhaust fumes can cause sickness or death.

If it is necessary to run an engine in an enclosed area, use an exhaust pipe extension to remove the fumes.

Always try to work in a well ventilated area.

1. Park machine on a level surface.
2. Move PTO switch to OFF position.
3. With the operator on the seat, start engine.

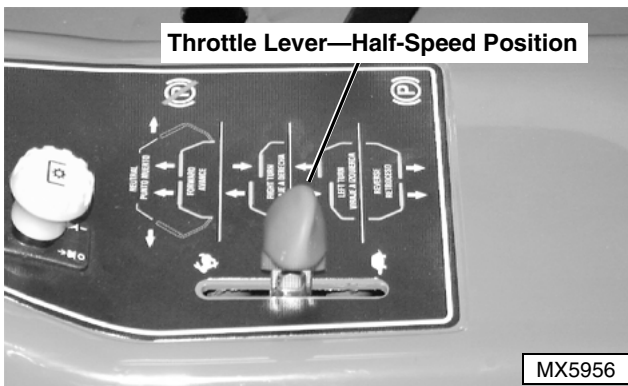

4. Move throttle lever to half-speed position.
5. Release park brake.

Control Levers—Neutral (Out) Position



6. Move control levers to NEUTRAL (out) position.
7. Check machine movement; the machine should not move.

#### Results:

- If movement is noted, perform Adjustment Procedure.

#### Adjustment Procedure:

1. Stop engine.
2. Engage parking brake.
3. Remove mower deck. (See MOWER DECK ASSEMBLY—Removal/Installation in ATTACHMENTS section.)

**IMPORTANT: DO NOT** place jack below the wheel motors. Damage to hydraulic hoses could result.

*NOTE: The drive wheels must be able to rotate freely.*

4. Use a safe lifting device to raise the machine high enough to remove weight from wheels. Place blocks or jackstand under machine frame.

Control Levers—Neutral (Out) Position

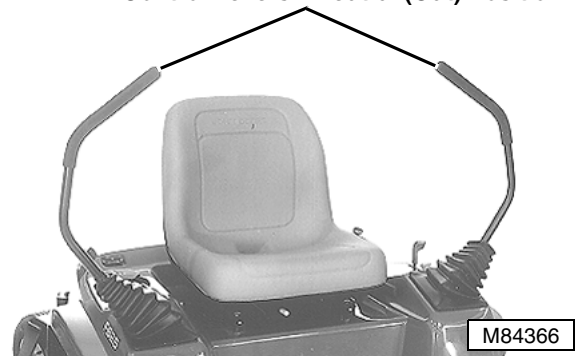

5. Move control levers to NEUTRAL (out) position.
6. Raise and latch cowling.

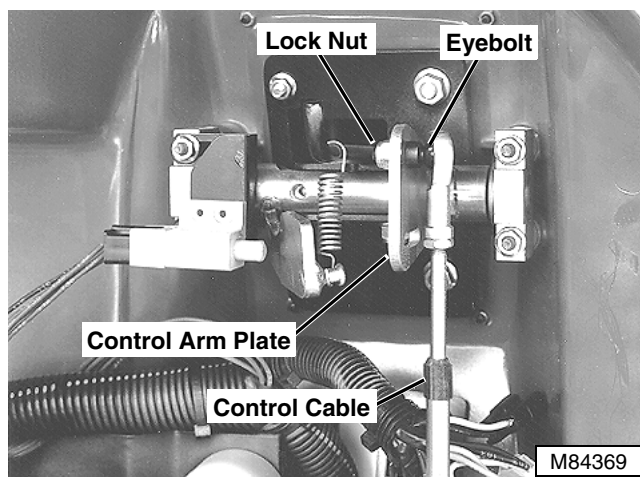

Model F620 and Model F680 (S.N. —020000)

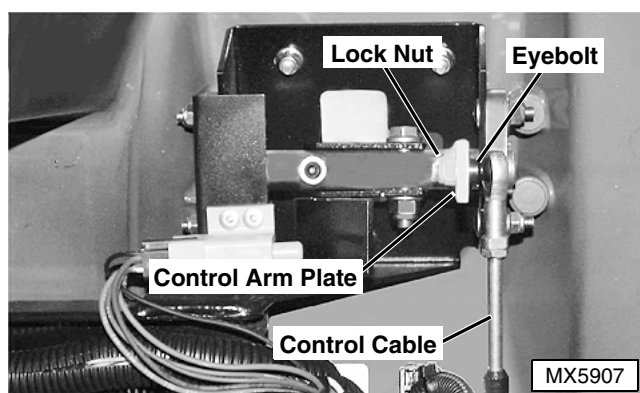

Model F680 (S.N. 020001—)

**IMPORTANT:** DO NOT loosen eyebolt jam nuts when left and right control cables are disconnected from the control arm plates. Control cable eyebolts **MUST** remain tightened in a fixed position to maintain an accurate adjustment.

*NOTE:* Disconnect control cables from both sides.

7. Remove lock nut from control cable eyebolt.
8. Remove control cable from control arm plate.
9. Depress the bottom of the seat to activate the seat safety switch, or use a jumper wire to bypass the seat switch circuit.
10. Start engine.
11. Release park brake.

## CAUTION

Help prevent serious personal injury. Use caution when performing this service function near hot engine components.

12. Observe for movement:

- If any movement is noted, perform the Transmission Drive Pump Dampener Adjustment procedure.
- If no movement is noted, proceed to the Control Cable Adjustment procedure.

## Transmission Drive Pump Dampener Adjustment

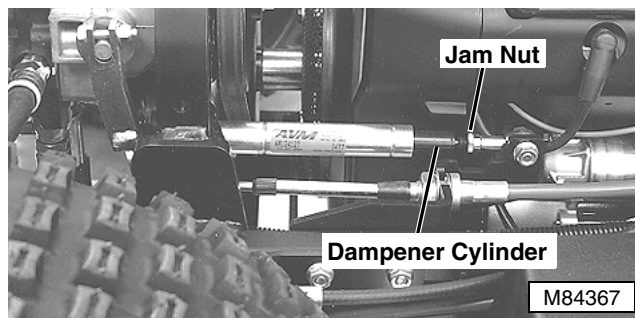

1. Loosen jam nuts.
2. Rotate the dampener cylinder until creep is gone.
  - To reduce forward movement:** Turn shock clockwise.
  - To reduce reverse movement:** Turn shock counterclockwise.
3. Tighten jam nut.
4. Repeat steps 1—3 (as needed) for other side.

## Control Cable Adjustment

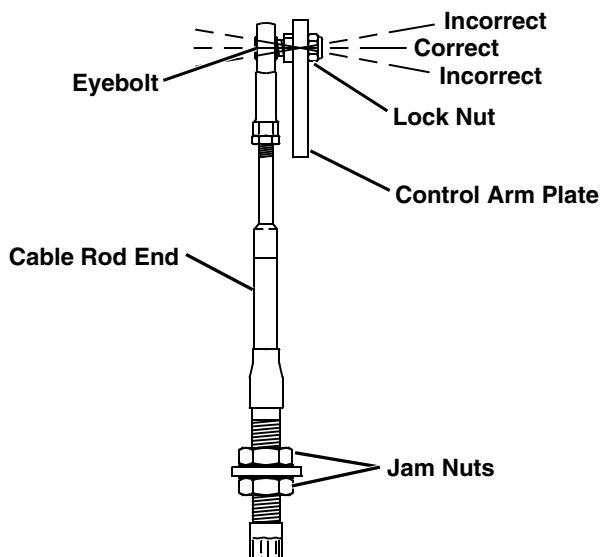

5. Loosen control cable jam nuts.

*NOTE:* Eyebolts should be installed and tightened at the bottom of the slot in the control arm plate.

6. Adjust rod ends up or down until steering rod eyebolt can be inserted absolutely perpendicular to the control arm plate. This can be done by adjusting the cable jam nuts.
7. Tighten jam nuts.

8. Perform check procedure to verify adjustment.
9. Repeat steps 5—7 as needed.
10. Stop engine.
11. Lower cowl.
12. Check tracking. (See TRACKING CHECK AND ADJUSTMENT.)

## TRACKING CHECK AND ADJUSTMENT

### Reason:

Correct tracking adjustment will allow the machine to maintain a straight line direction of travel.

### Check Procedure:

1. Park machine on a level surface.
2. Release park brake.

*NOTE: To ensure straight line tracking, drive wheel tire pressure must be equal.*

3. Check drive wheel tire pressure.

Control Levers—Neutral (Centered) Position

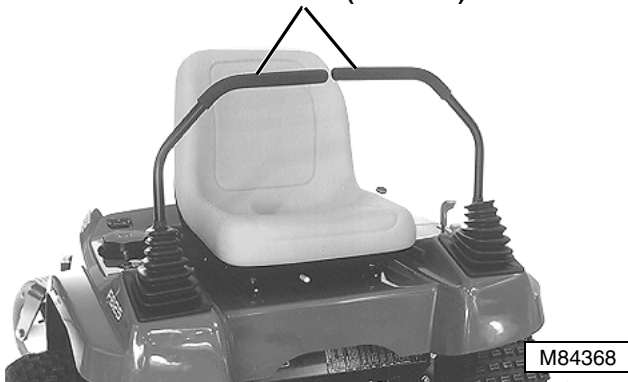

4. Move both control levers inward to centered neutral (centered) position.
5. With the operator on the seat, start engine.
6. While holding both control levers together, push both control levers forward to desired mowing speed.

### Results:

- If machine travels to the right or left, perform Adjustment Procedure.

### Adjustment Procedure:

1. Park machine on a level surface.
2. Move key switch to OFF position.
3. Engage park brake.
4. Raise and lock cowl.

Control Levers—Centered Neutral Position

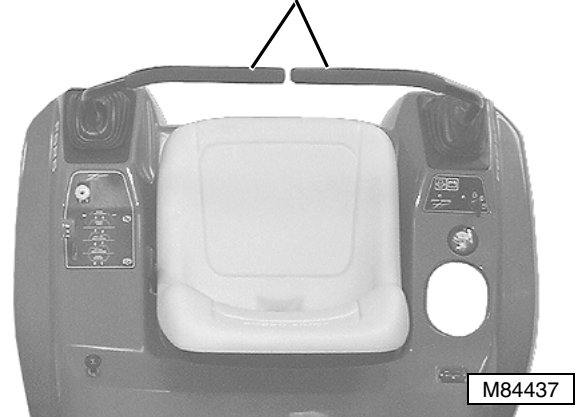

5. Move both control levers inward to neutral (centered) position.

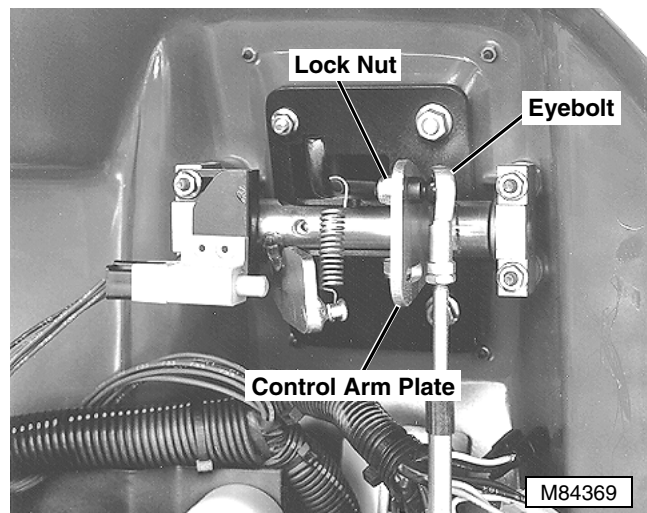

Model F620 and Model F680 (S.N. —020000)

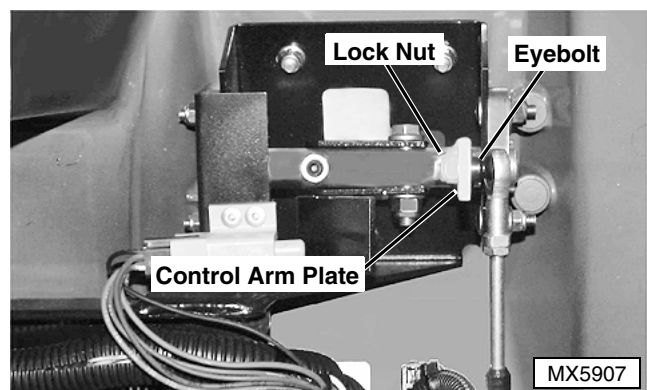

Model F680 (S.N. 020001—)

6. Loosen the lock nut securing the control cable to the control arm plate.

**NOTE:** *If the machine moves to the left, adjust the right control lever. If the machine moves to the right, adjust the left control lever.*

*Adjustment should be performed in 6 mm (1/4 in.) increments.*

7. Slide cable rod inside the control arm plate adjustment slot. Slide cable rod end up (toward cowl) to slow the hydraulic pump.
8. Tighten lock nut.
9. With the operator on the seat, perform Check Procedure. Repeat Adjustment Procedure if needed.

## CONTROL LEVER HEIGHT ADJUSTMENT

### Reason:

To align the control levers.

### Procedure:

1. Park machine on a level surface.
2. Move key switch to OFF position.
3. Engage park brake.

Control Levers—Driving Position

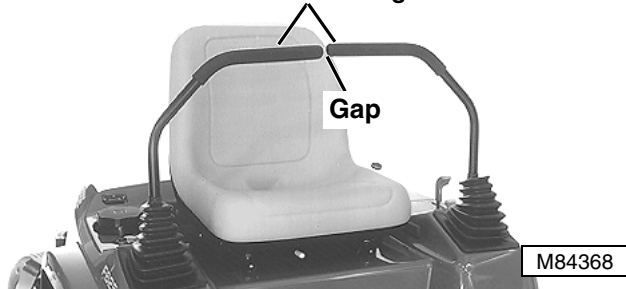

4. Position control levers in driving (in) position.
5. Check lever alignment; levers should align (height and fore and aft) with approximately **6 mm (0.25 in.)** gap between the levers. If adjustment is required proceed to step 6.
6. Raise and lock cowl.

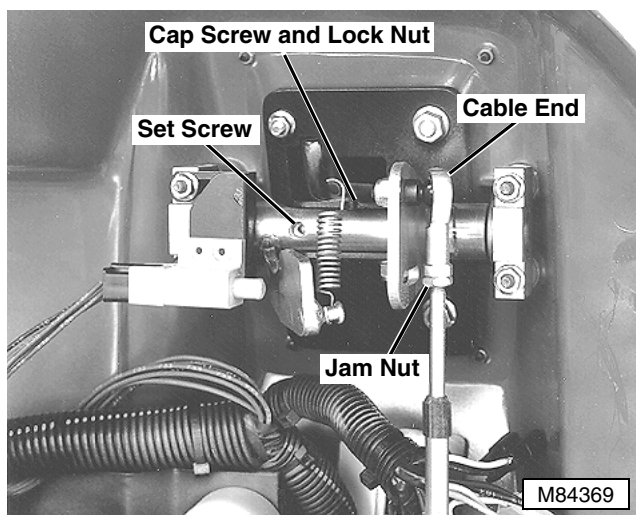

Model F620 and Model F680 (S.N. —020000)

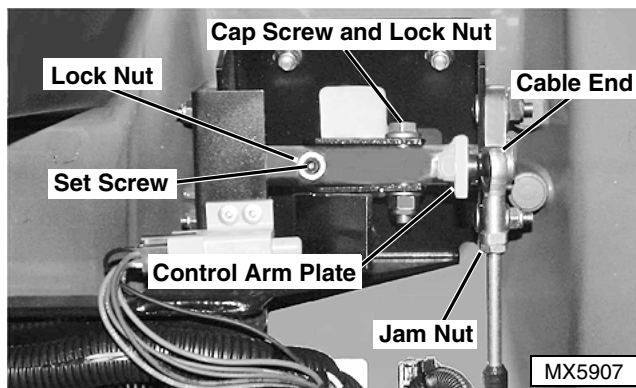

Model F680 (S.N. 020001—)

7. To adjust the height gap, loosen cap screw and lock nut.
8. Loosen set screw lock nut (if equipped), and adjust set screw.  
**To increase gap:** Turn set screw clockwise.  
**To decrease gap:** Turn set screw counterclockwise.
9. To adjust lever fore and aft alignment, remove cable end, loosen jam nut and adjust as follows:  
**To adjust lever forward:** Turn cable end clockwise (shorten cable).  
**To adjust lever rearward:** Turn cable end counterclockwise (lengthen cable).
10. Tighten jam nut.
11. Connect cable to bracket. Position cable to bottom of slot.
12. Check lever alignment.
13. Check neutral (zero creep) adjustment. (See NEUTRAL [ZERO CREEP] CHECK AND ADJUSTMENT.)

## HYDRAULIC PUMP FLOW TEST

## ⚠ CAUTION

Avoid injury! Escaping fluid under pressure can penetrate the skin causing serious injury. Avoid the hazard by relieving pressure before disconnecting hydraulic or other lines. Tighten all connections before applying pressure. Search for leaks with a piece of cardboard. Protect hands and body from high-pressure fluids.

If an accident occurs, see a doctor immediately. Any fluid injected into the skin must be surgically removed within a few hours or gangrene may result. Doctors unfamiliar with this type of injury should reference a knowledgeable medical source. Such information is available from Deere & Company Medical Department in Moline, Illinois, U.S.A. Information may be obtained in the United States and Canada by calling 1-800-822-8262.

**NOTE:** Two persons may be required to perform this test. If unavailable, disconnect seat switch harness connector and install a jumper wire across seat switch terminals in main harness connector.

### Reason:

To determine if the hydraulic pump or wheel motor is faulty. Proper operation of the hydraulic pump indicates a faulty wheel motor.

### Test Conditions:

- Drive tires raised from ground.
- Park brake released.
- Hydraulic pump bypass valve fully closed.
- Engine at FAST idle.
- Directional control lever in FORWARD position.

### Procedure:

1. Park machine safely.
2. Raise drive tires off the ground. Block remaining tires to prevent machine from moving.

**NOTE:** Note position of lines/hoses to ensure correct installation.

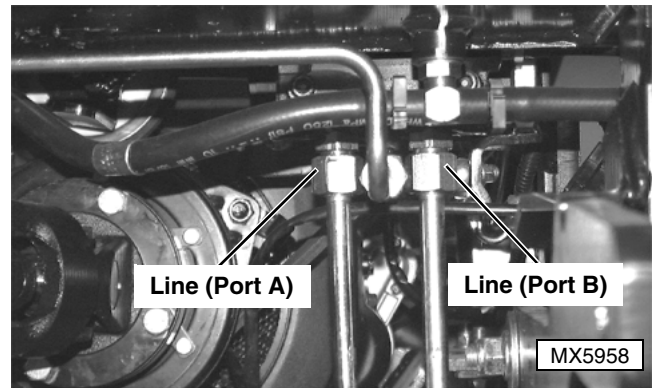

Model F680 (S.N. 020001—)

**IMPORTANT:** When removing lines, plug the ports on wheel motor to prevent damage to motor.

3. On F680 (S.N. 020001—), disconnect lines from ports A and B of pump and wheel motor, and remove lines. DO NOT remove adapters from the ports.

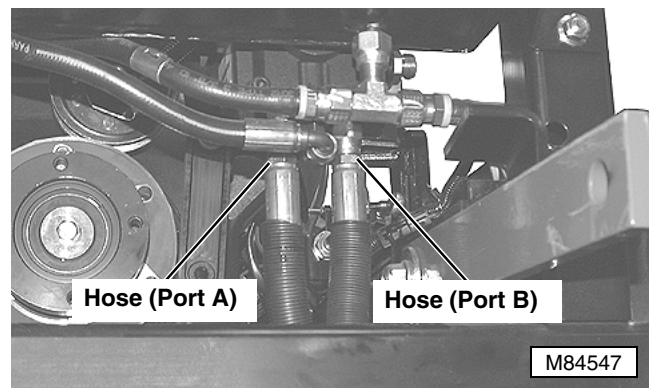

Model F620 and F680 (S.N. —020000)

4. On F620 and F680 (S.N. —020000), disconnect hoses from pump. Install 38H1161 Adapter (with O-rings R26375 and T77857) into ports A and B of pump.

## ⚠ CAUTION!

Avoid injury! To avoid bodily injury, ensure all fittings and hoses are attached securely. This test is being completed on the machine's high pressure system lines.

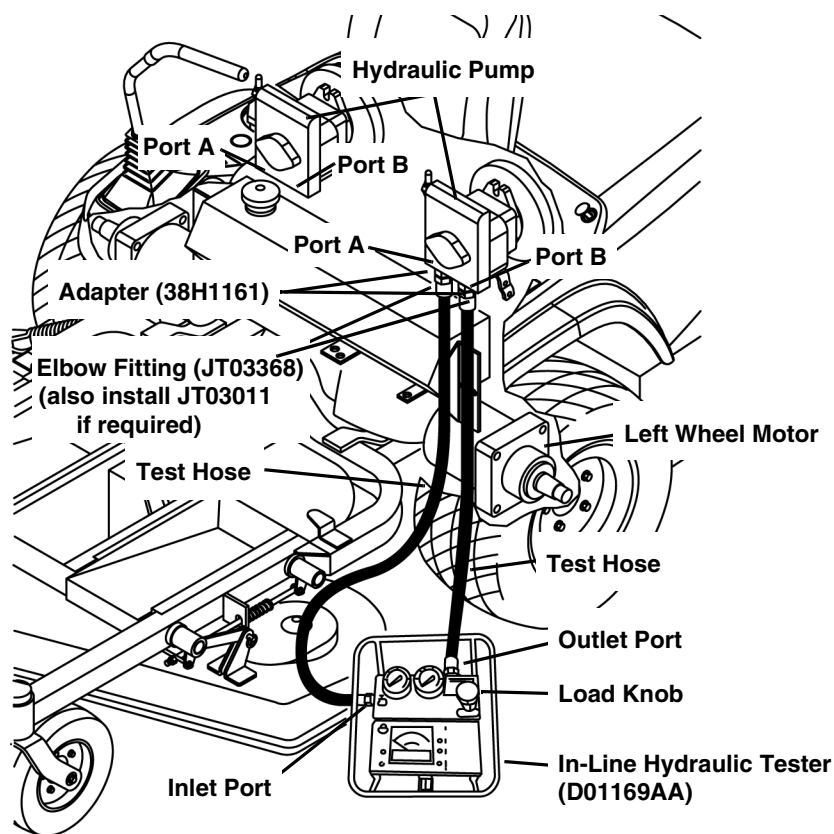

MX5974

5. Install JT03368 Elbow Fitting on adapters in ports A and B of pump.

**NOTE:** Use a suitable in-line hydraulic tester, 3—15 gpm, 0—20684 kPa (0—3000 psi). JT05469 Hydraulic Flowmeter Kit may also be used. In addition to the Adapter and Elbow identified in this procedure, one additional fitting will be needed to adapt to flowmeter: JT03011, 3/4 M NPT x 1/2 M NPT Fitting.

6. Connect inlet and outlet hoses of D01169AA In-Line Hydraulic Tester to pump as shown.
7. Tighten all fittings.
8. Set load knob on in-line hydraulic tester all the way to DECREASE.

## CAUTION

Engine exhaust fumes can cause sickness or death.

If it is necessary to run an engine in an enclosed area, use an exhaust pipe extension to remove the fumes.

9. Start the engine.
10. Bring the engine speed up to FAST idle.

**IMPORTANT: Avoid damage! DO NOT stroke the control arm in REVERSE. The hydraulic tester is not bi-directional.**

11. Using the directional control lever for the pump being tested, stroke the control arm to the full FORWARD position and hold.
12. Increase load by turning the load knob on hydraulic tester clockwise/INCREASE until 2068 kPa (300 psi) is reached. Record the gpm reading.
13. Continue to increase load by turning the load knob clockwise/INCREASE until 7584 kPa (1100 psi) is reached. Record the gpm reading.
14. Decrease load completely by turning the load knob counterclockwise/DECREASE all the way.
15. Subtract the second gpm reading (high load) from the first gpm reading (low load) and record the difference.

**Pump flow should not drop more than 5.6 L (1.5 gpm) under heavy load.**

### Results:

- If pump flow is not within specification, repair or replace the hydraulic pump. (See HYDRAULIC PUMPS—Removal/Installation.)
- If pump is operating properly, repair or replace the wheel motor. (See WHEEL MOTORS—Removal/Installation.)

REPAIR

HYDRAULIC PUMP DRIVE BELT

Removal/Installation

1. Remove mower deck drive shaft. (See MOWER DECK DRIVE SHAFT—Removal/Installation in ATTACHMENTS section.)

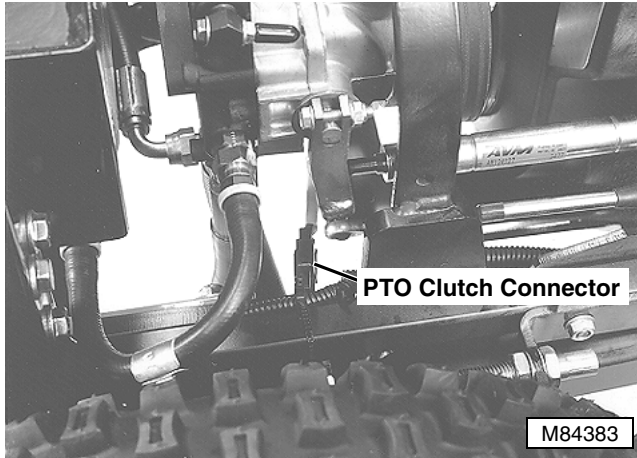

2. Disconnect PTO clutch wiring connector.

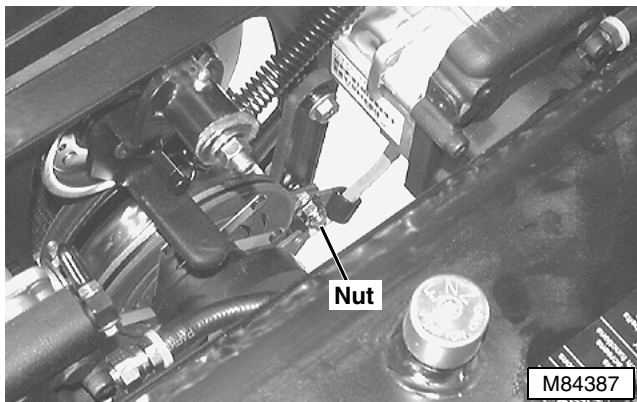

3. Remove lower clutch anti-rotation strap nut, if equipped (S.N. —020000 only).

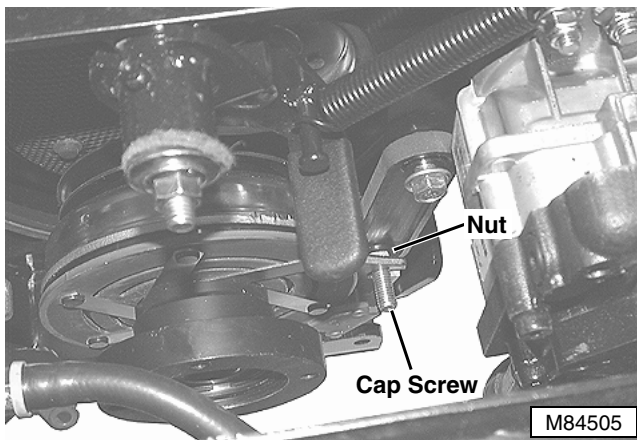

4. Hold nut between the clutch tether strap and clutch and remove cap screw, if equipped (S.N. —020000 only).

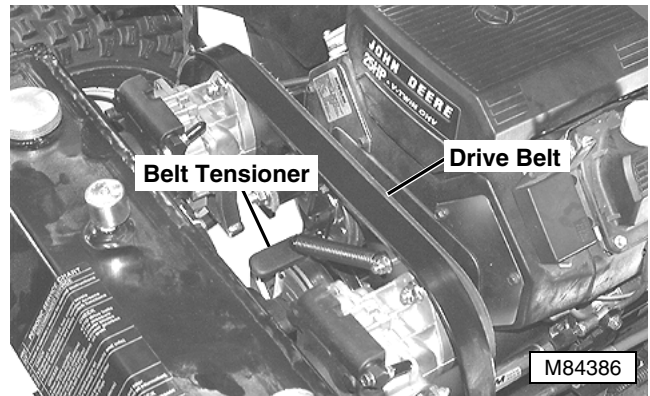

5. Release belt tensioner.
6. Remove drive belt.

Installation is done in the reverse order of removal.

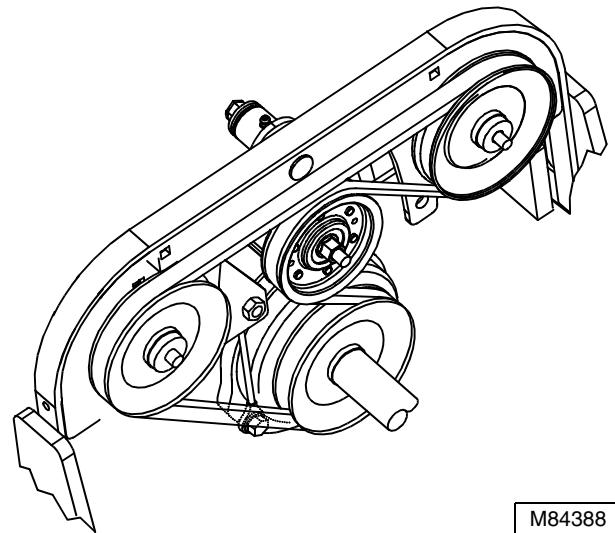

- Route belt as shown.



# HYDRAULIC PUMP DRIVE BELT TENSIONER ASSEMBLY

## Repair

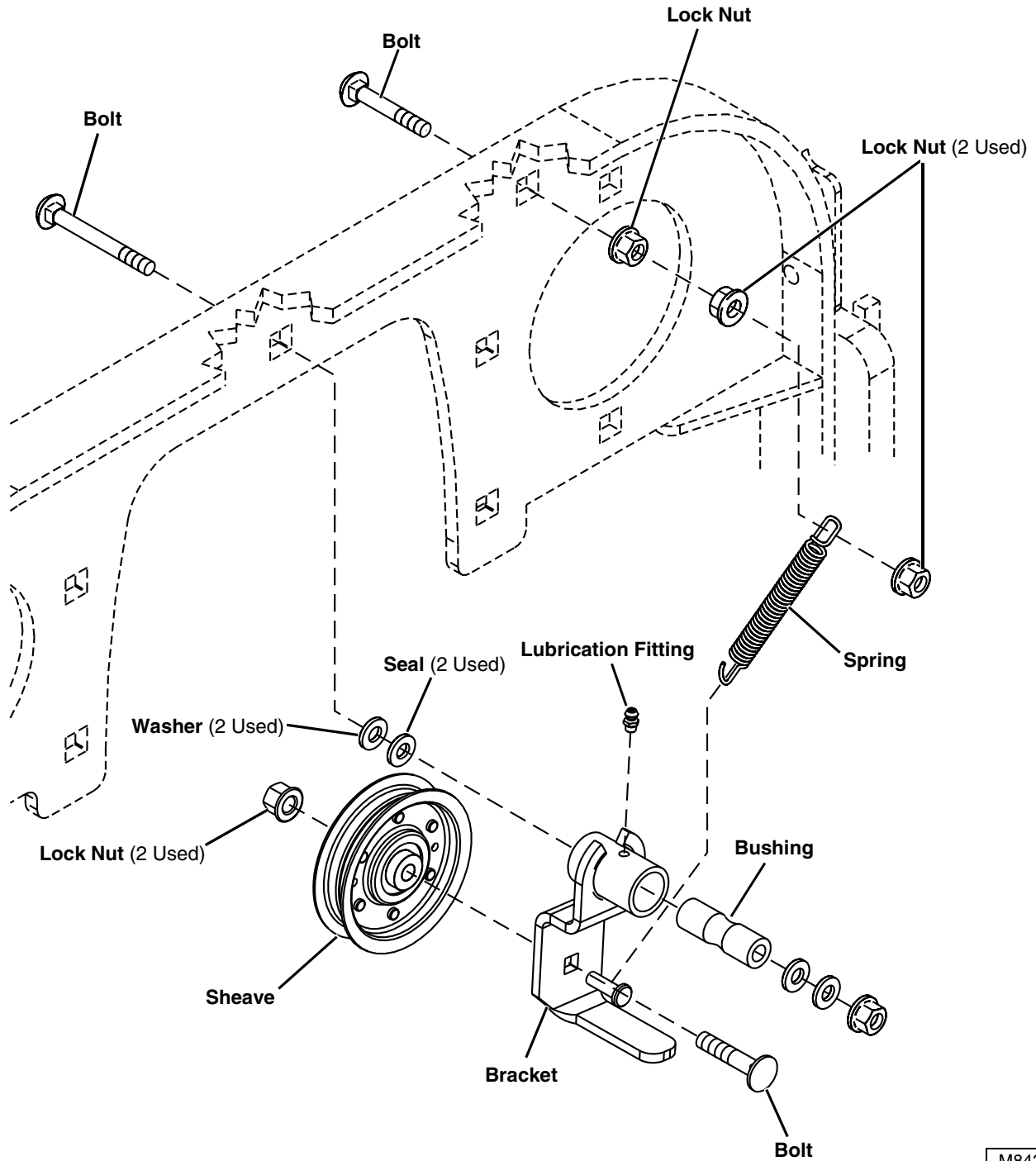

M84370

# CONTROL CABLES

## Removal/Installation

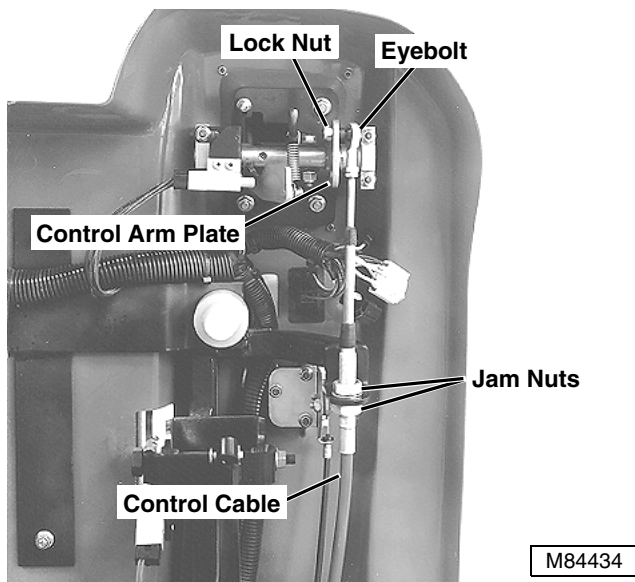

Model F620 and Model F680 (S.N. —020000)

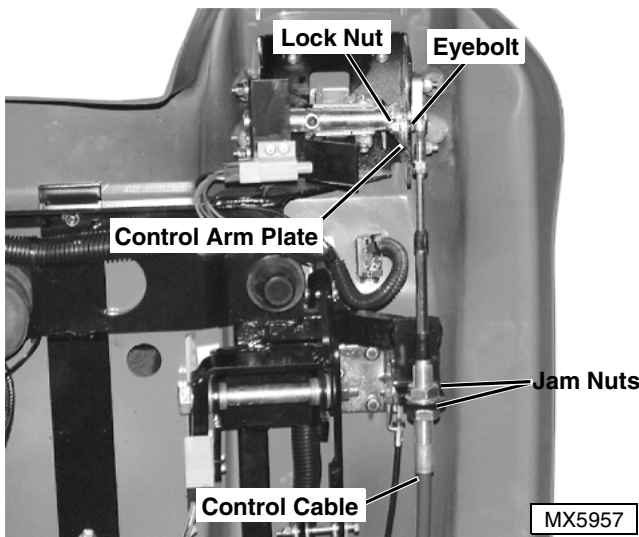

Model F680 (S.N. 020001—)

1. Remove lock nut from control cable eyebolt.
2. Remove control cable from control arm plate.
3. Loosen control cable jam nuts.
4. Remove control cable from bracket.

- Inspect all parts for wear or damage. Replace parts as needed.
- Apply grease to lubrication fitting. (See GREASE in SPECIFICATIONS AND INFORMATION section.)

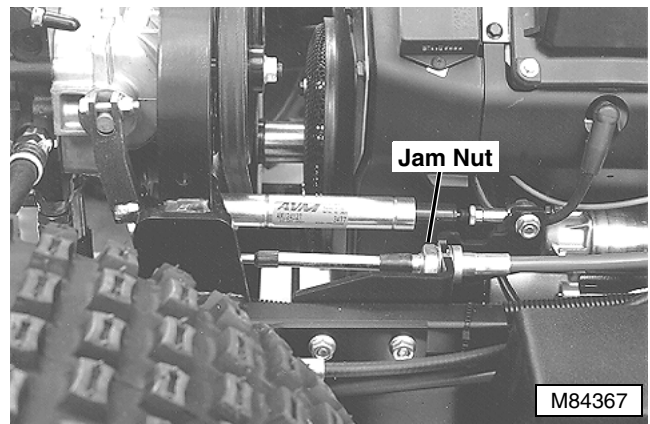

5. Loosen lower cable jam nut.

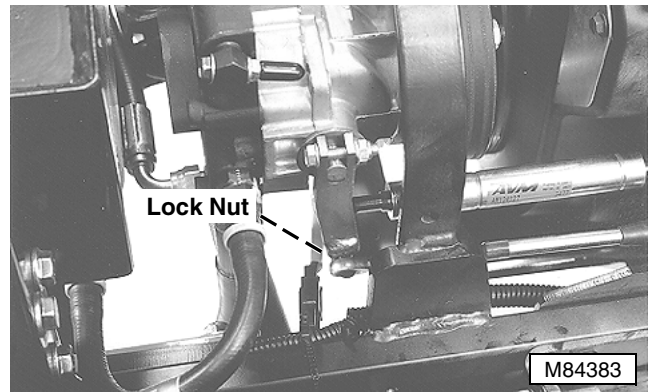

Model F620 Shown

6. Remove lock nut from control cable eyebolt.
7. Remove control cable from control arm plate.

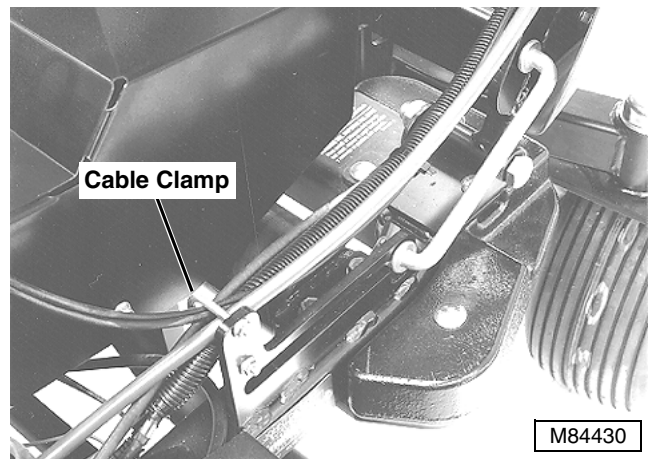

8. Remove cable clamp.
9. Remove control cable.

**Installation is done in the reverse order of removal.**

- Adjust control cable. (See NEUTRAL [ZERO CREEP] CHECK AND ADJUSTMENT.)

**CONTROL LEVER ASSEMBLIES—  
MODEL F620 AND MODEL F680 (S.N. —020000)**

**Repair**

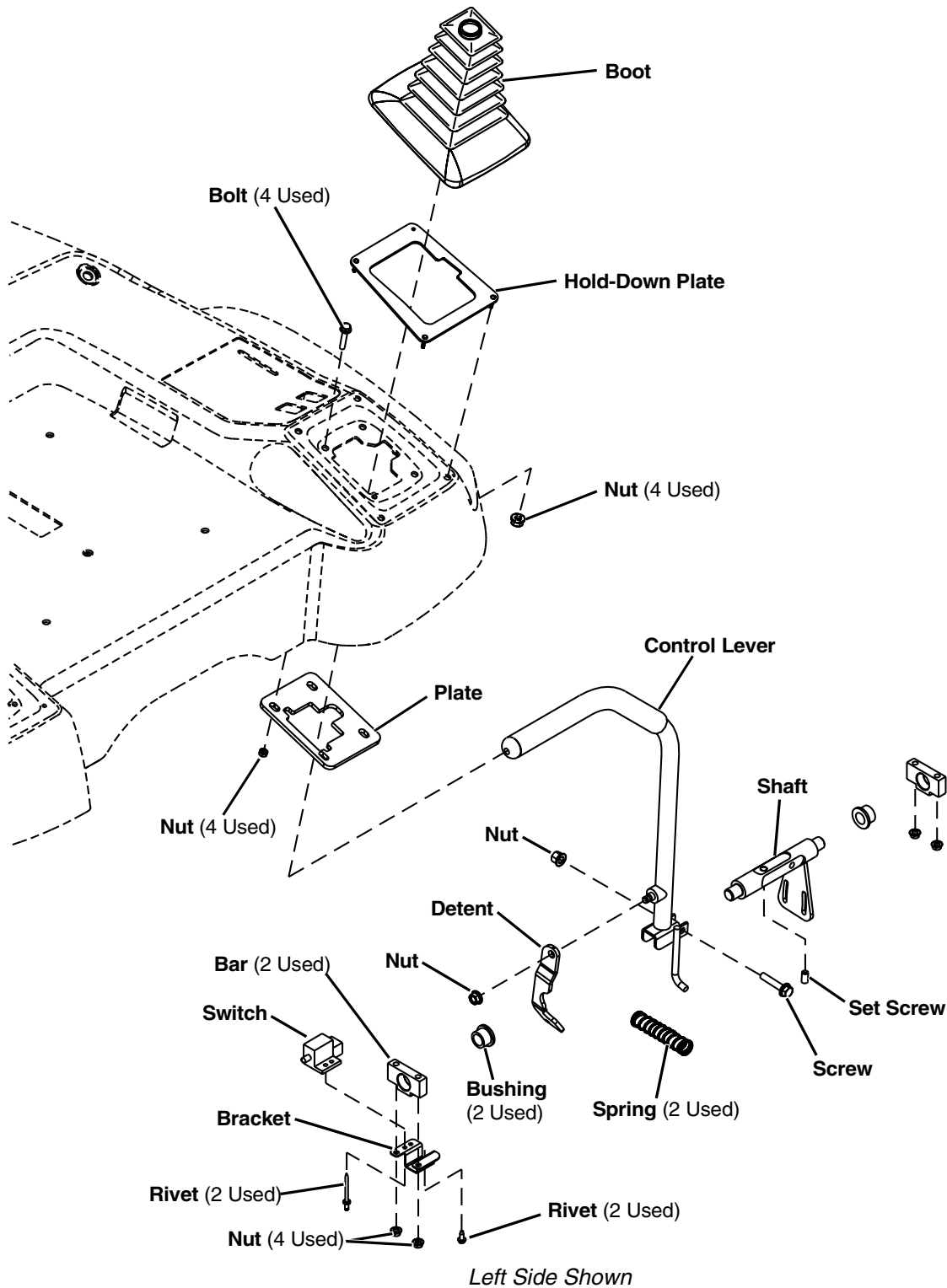

- Inspect all parts for wear or damage. Replace parts as needed.
- Adjust control cable. (See NEUTRAL [ZERO CREEP] CHECK AND ADJUSTMENT.)

- Adjust control lever height. (See CONTROL LEVER HEIGHT ADJUSTMENT.)

## CONTROL LEVER ASSEMBLIES— MODELS F680 (S.N. 020001— ) AND F687

### Repair

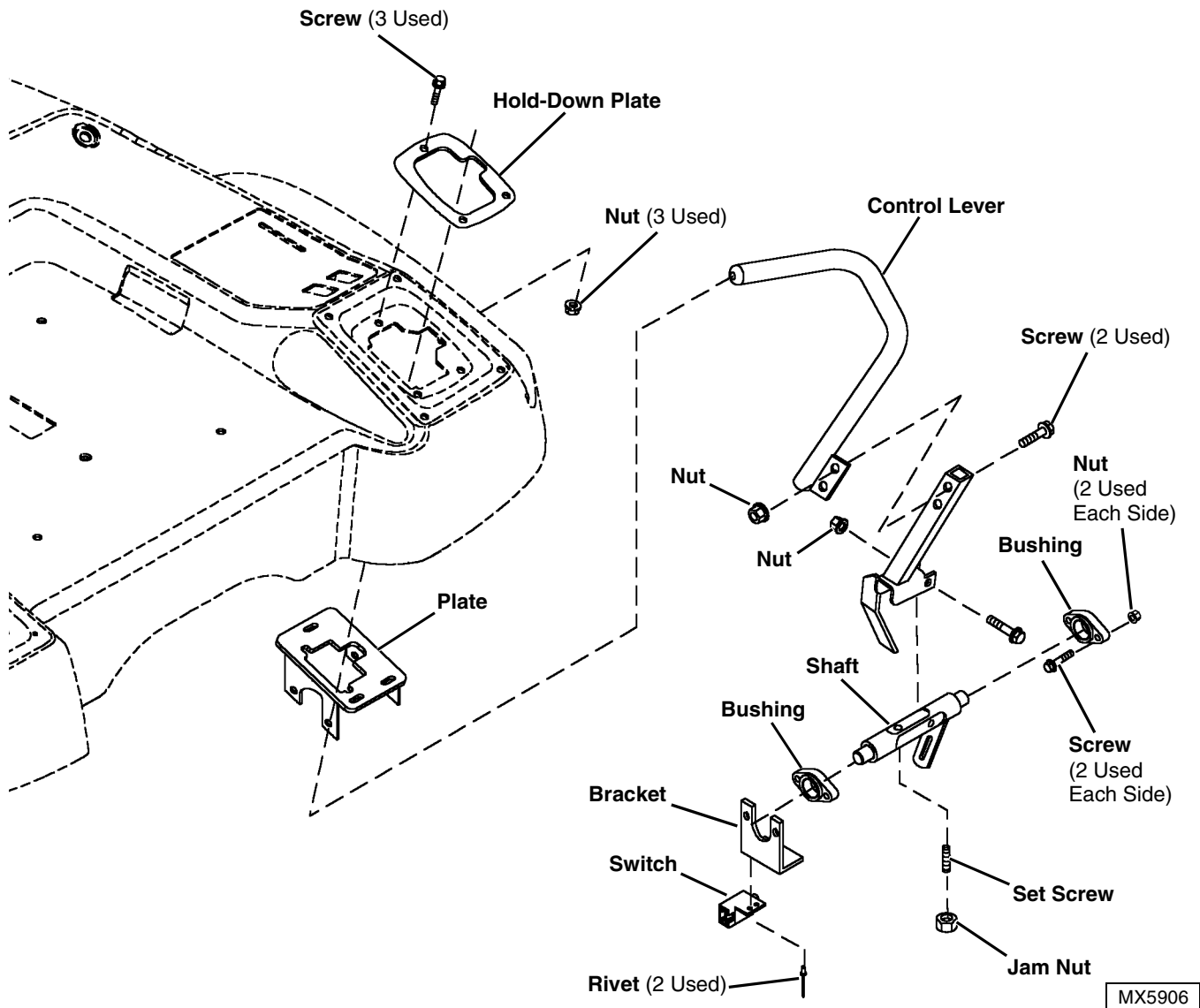

*Left Side Shown*

- Inspect all parts for wear or damage. Replace parts as needed.
- Adjust control cable. (See NEUTRAL [ZERO CREEP] CHECK AND ADJUSTMENT.)
- Adjust control lever height. (See CONTROL LEVER HEIGHT ADJUSTMENT.)

HYDRAULIC PUMPS

Removal/Installation

**CAUTION**

Escaping fluid under pressure can penetrate the skin causing serious injury. Avoid the hazard by relieving pressure before disconnecting hydraulic or other lines. Tighten all connections before applying pressure. Search for leaks with a piece of cardboard. Protect hands and body from high-pressure fluids.

If an accident occurs, see a doctor immediately. Any fluid injected into the skin must be surgically removed within a few hours or gangrene may result. Doctors unfamiliar with this type of injury should reference a knowledgeable medical source. Such information is available from Deere & Company Medical Department in Moline, Illinois, U.S.A. Information may be obtained in the United States and Canada only by calling 1-800-822-8262.

1. Remove mower deck. (See MOWER DECK ASSEMBLY—Removal/Installation in ATTACHMENTS section.)
2. Remove pump drive belt. (See HYDRAULIC PUMP DRIVE BELT—Removal/Installation.)

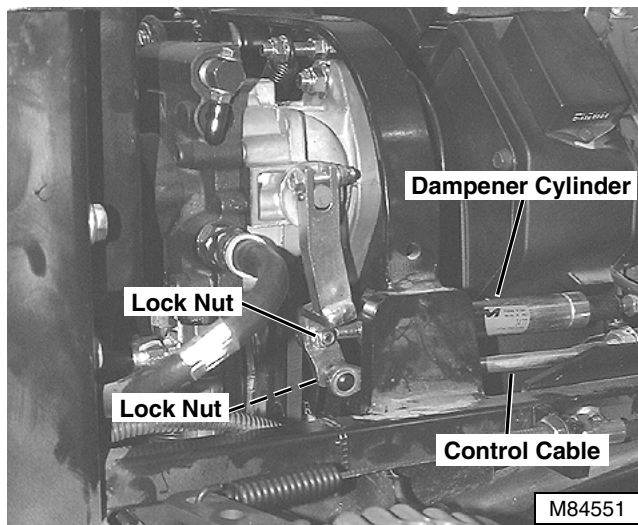

NOTE: Wheel removed for photo clarity only.

3. Remove lock nut from control cable eyebolt.
4. Remove control cable from control arm.
5. Remove lock nut from dampener cylinder and disconnect dampener cylinder from control arm.

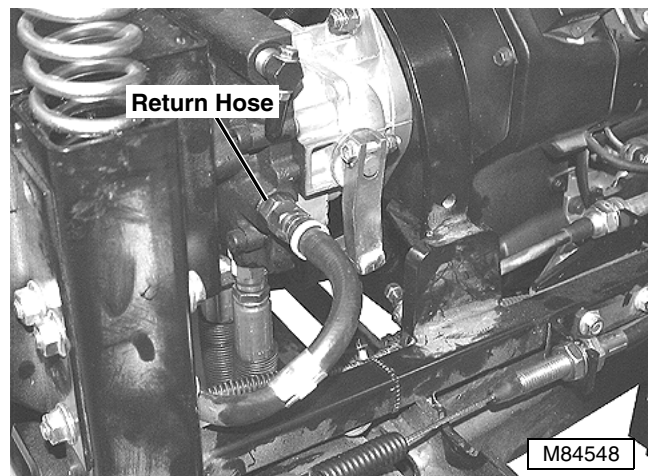

NOTE: Cap the return hose to prevent draining the oil reservoir.

6. Disconnect return hose from pump.

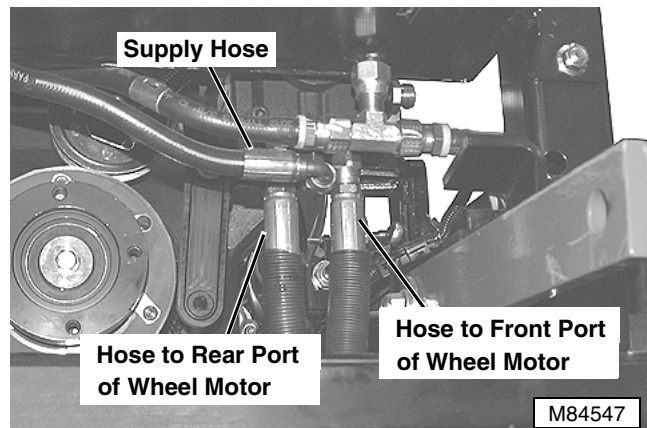

Model F620 and Model F680 (S.N. —020000)

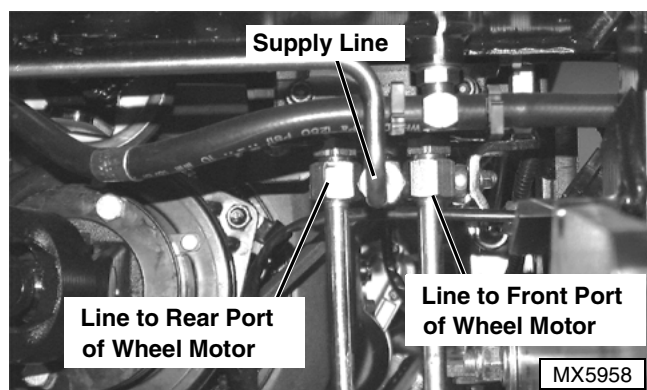

Model F680 (S.N. 020001—)

NOTE: Cap the supply hose or line to prevent draining the oil reservoir.

Note position of hoses and lines to ensure correct installation.



**Suggest:**

**If the above button click is invalid.**

**Please download this document**

**first, and then click the above link**

**to download the complete manual.**

**Thank you so much for reading**

7. Disconnect supply hose or line from pump.
8. Disconnect wheel motor hoses or lines from pump.

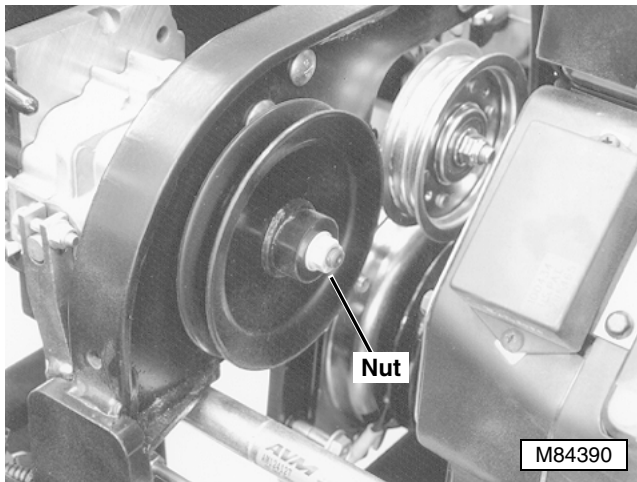

9. Remove nut from drive pulley.

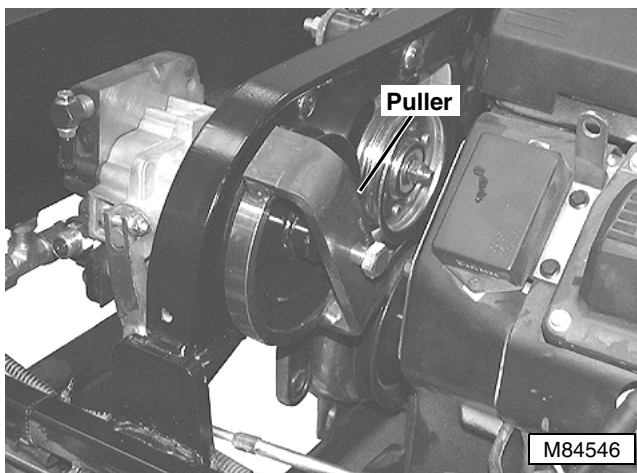

10. Remove drive pulley using a JDG1240 Sheave Puller.

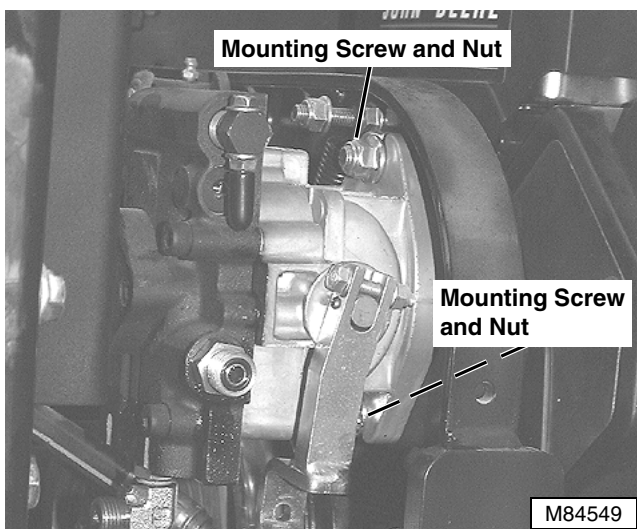

Model F620 Shown

11. Remove mounting screws and nuts.
12. Remove hydraulic pump.

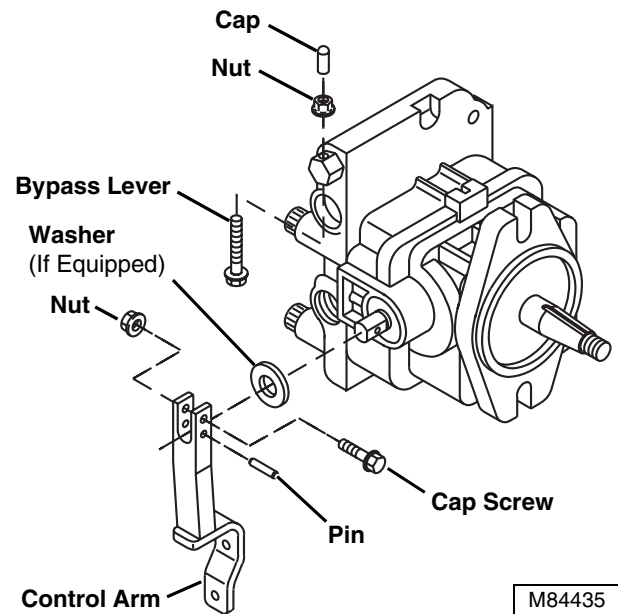

Model F620 Shown

13. If hydraulic pump is to be repaired or replaced, remove control arm and bypass lever.

**Installation is done in the reverse order of removal.**

- Apply Multi-Purpose SD Polyurea Grease to pump input shaft and key. (See GREASE in SPECIFICATIONS AND INFORMATION section.)
- Tighten pulley retaining nut to **45 N•m (33 lb-ft)**.
- When facing back of either pump, the left hydraulic pump hose/line is connected to the rear port of the wheel motor
- Fill hydraulic reservoir to correct level with oil of proper specifications. (See HYDROSTATIC TRANSMISSION OIL in SPECIFICATIONS AND INFORMATION section.)



**<https://www.ebooklibonline.com>**

Hello dear friend!

Thank you very much for reading.

Enter the link into your browser.

The full manual is available for immediate download.

**<https://www.ebooklibonline.com>**