

**JOHN DEERE**  
**AG & TURF DIVISION**

---

**John Deere Tractor**  
**X750, X754, X758**

OMM166906 J2

**OPERATOR'S MANUAL**



**JOHN DEERE**

**⚠ WARNING:** Diesel engine exhaust and some of its constituents are known to the State of California to cause cancer, birth defects, and other reproductive harm.

California Proposition 65 Warning

North American Version  
Printed in U.S.A.

# Introduction

---

## Thank You for Purchasing a John Deere Product

We appreciate having you as a customer and wish you many years of safe and satisfied use of your machine.

## Using Your Operator's Manual

This manual is an important part of your machine and should remain with the machine when you sell it.

Reading your operator's manual will help you and others avoid personal injury or damage to the machine. Information given in this manual will provide the operator with the safest and most effective use of the machine. Knowing how to operate this machine safely and correctly will allow you to train others who may operate this machine.

If you have an attachment, use the safety and operating information in the attachment operator's manual along with the machine operator's manual to operate the attachment safely and correctly.

This manual and safety signs on your machine may also be available in other languages (see your authorized dealer to order).

Sections in your operator's manual are placed in a specific order to help you understand all the safety messages and learn the controls so you can operate this machine safely. You can also use this manual to answer any specific operating or servicing questions. A convenient index located at the end of this book will help you to find needed information quickly.

The machine shown in this manual may differ slightly from your machine, but will be similar enough to help you understand our instructions.

RIGHT-HAND and LEFT-HAND sides are determined by facing in the direction the machine will travel when going forward. When you see a broken line (-----), the item referred to is hidden from view.

Before delivering this machine, your dealer performed a predelivery inspection to ensure best performance.

## Special Messages

Your manual contains special messages to bring attention to potential safety concerns, machine damage as well as helpful operating and servicing information. Please read all the information carefully to avoid injury and machine damage.



**CAUTION: Avoid injury! This symbol and text highlight potential hazards or death to the operator or bystanders that may occur if the hazards or procedures are ignored.**

**IMPORTANT: Avoid damage! This text is used to tell the operator of actions or conditions that might result in damage to the machine.**

***NOTE: General information is given throughout the manual that may help the operator in the operation or service of the machine.***

## Attachments for Your Machine

There's a John Deere attachment or kit to make your new machine perform more tasks or be more versatile, whether your machine is a lawn tractor or compact utility tractor or a utility vehicle.

You can check out the entire line of attachments for your machine at [JohnDeere.com](http://JohnDeere.com) or ask your John Deere dealer. From aerators to electric lift kits to tillers, there's a John Deere attachment or kit to fill every need.

# Product Identification

---

## Record Identification Numbers

X750, X754, X758

PIN (010001- )

If you need to contact an Authorized Service Center for information on servicing, always provide the product model and serial number.

You will need to locate the model and serial number for the machine and for the engine of your machine and record the information in the spaces provided below.

DATE OF PURCHASE:

\_\_\_\_\_

DEALER NAME:

\_\_\_\_\_

DEALER PHONE:

\_\_\_\_\_

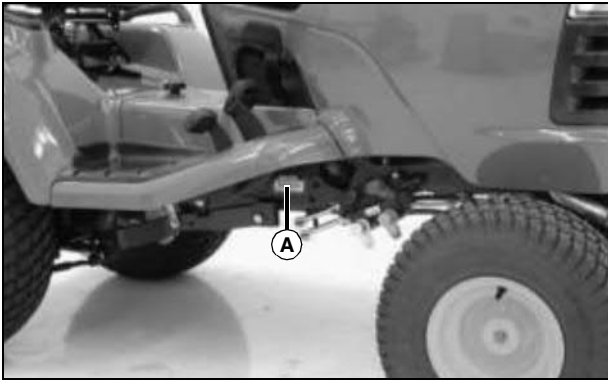

MX13553

PRODUCT IDENTIFICATION NUMBER (A):

-----

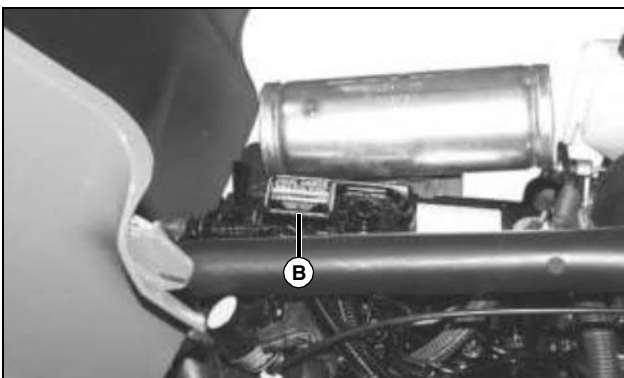

MX21823

ENGINE SERIAL NUMBER (B):

-----

**<https://www.ebooklibonline.com>**

Hello dear friend!

Thank you very much for reading.

Enter the link into your browser.

The full manual is available for immediate download.

**<https://www.ebooklibonline.com>**

# Table of Contents

---

Safety Labels .....	5
Safety .....	10
Machine Cleanout.....	17
Operating - Controls .....	19
Operating.....	20
Replacement Parts .....	41
Service Intervals .....	42
Service Lubrication.....	43
Service Engine .....	45
Service Transmission.....	55
Service Electrical.....	58
Service Miscellaneous.....	62
Troubleshooting .....	67
Storage .....	70
Specifications .....	72
Warranty .....	75
Index.....	78

Original Instruction

All information, illustrations and specifications in this manual are based on the latest information at the time of publication. The right is reserved to make changes at any time without notice.

COPYRIGHT© 2012

Deere & Co.

John Deere Ag & Turf Division

All rights reserved

Previous Editions

COPYRIGHT©

OMM166906 J2 - English

# Safety Labels

## Safety Label Location

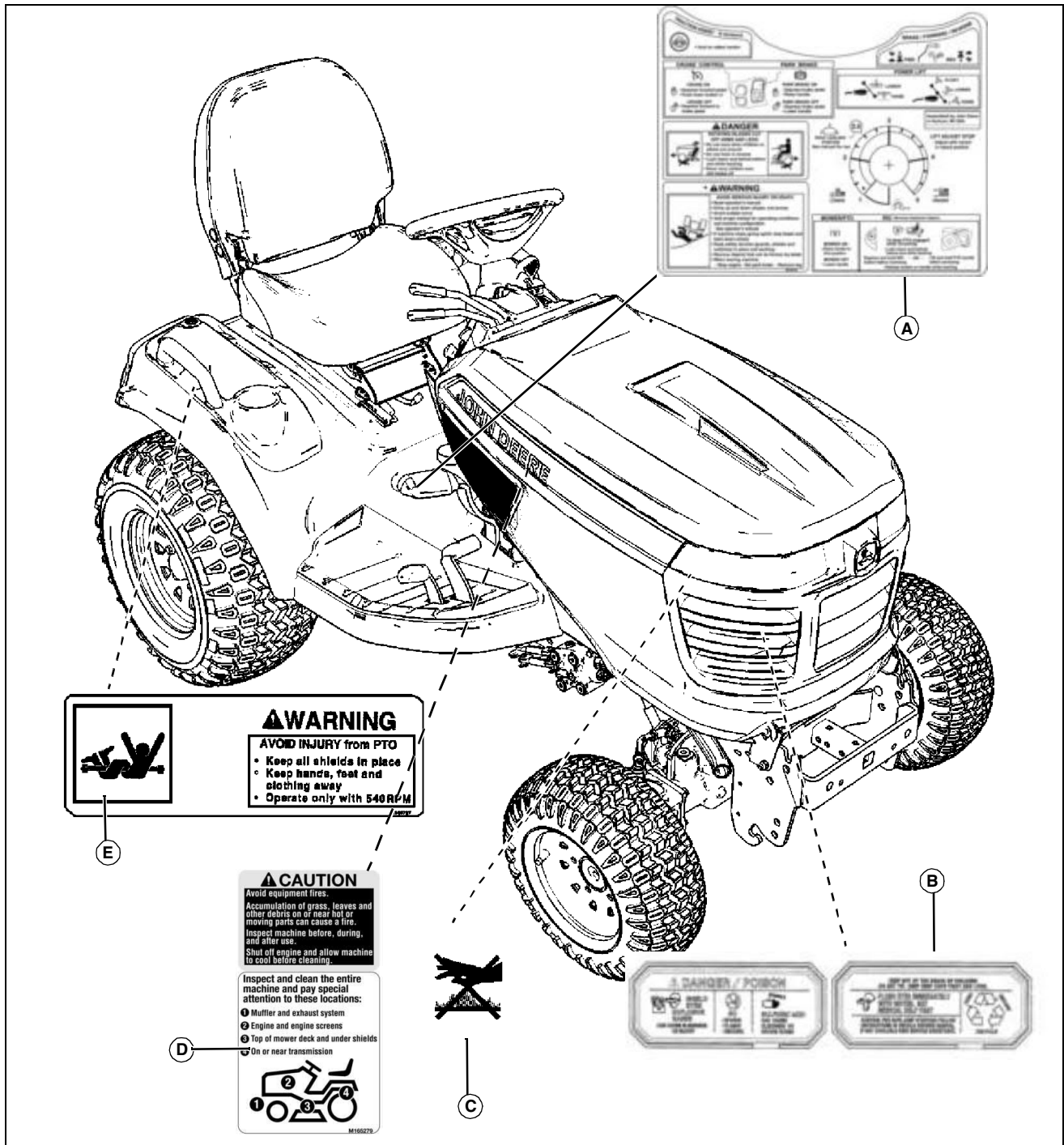

MX51748

E - WARNING M146727

Picture Note: Use label number listed in table below to locate complete text of safety label message following this illustration.

- A - DANGER M165732
- B - DANGER AM131035 (ON BATTERY)
- C - CAUTION (MOLDED INTO MUFFLER)
- D - CLEANOUT M165279

# Safety Labels

## Pictorial Safety Label Location

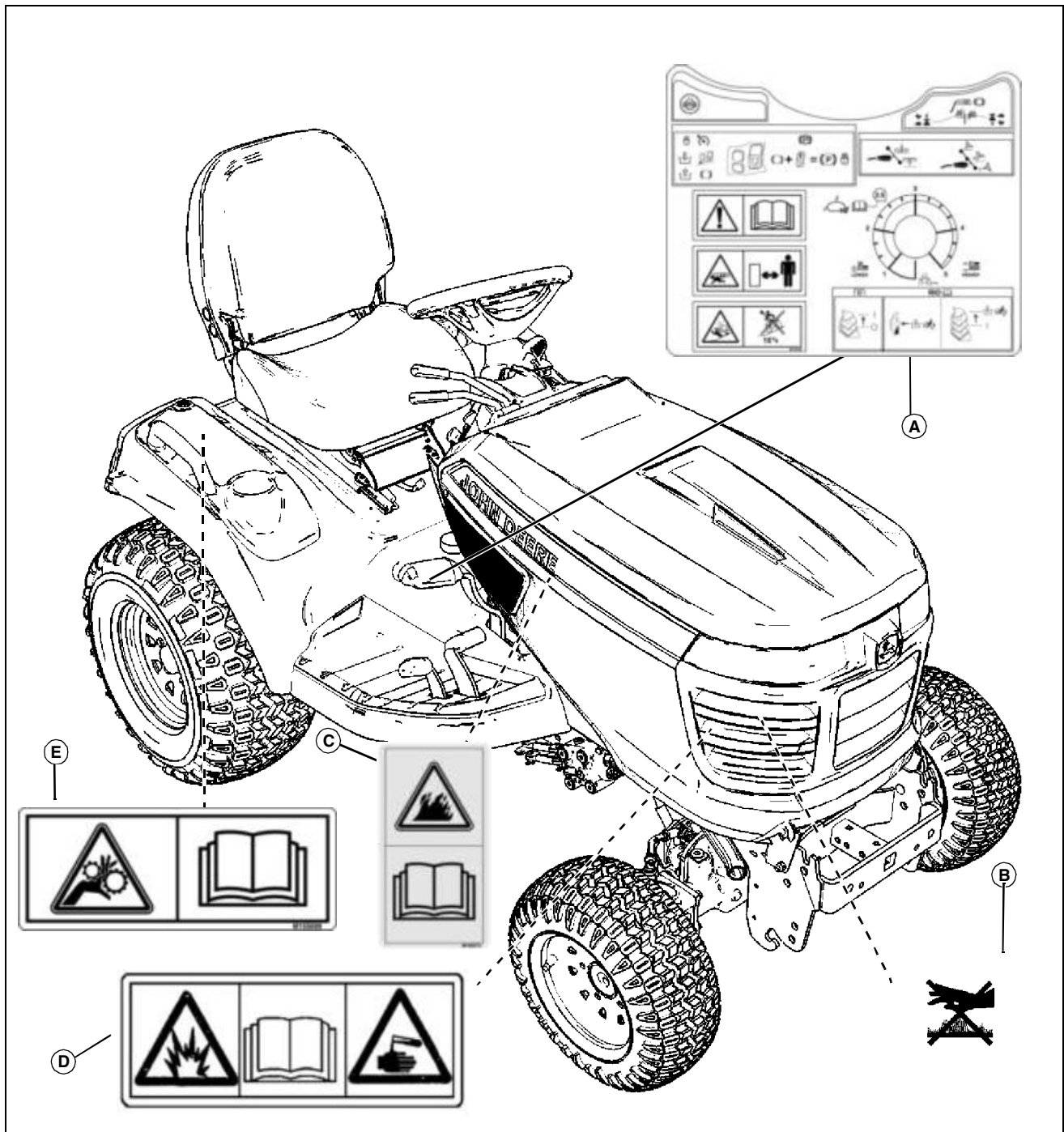

MX51748

**Picture Note:** Use label number listed in table below to locate complete text of safety label message following this illustration.

- B - CAUTION (MOLDED INTO MUFFLER)**
- C - CAUTION M165273**
- D - DANGER M133159 (ON BATTERY))**
- E - WARNING M155699**

Pictorial labels are required for certain parts of the world. Your machine may not be equipped with these labels.

**A - DANGER M167292**

# Safety Labels



## Understanding The Machine Safety Labels

The machine safety labels shown in this section are placed in important areas on your machine to draw attention to potential safety hazards.

On your machine safety labels, the words DANGER, WARNING, and CAUTION are used with this safety-alert symbol. DANGER identifies the most serious hazards.

The operator's manual also explains any potential safety hazards whenever necessary in special safety messages that are identified with the word, CAUTION, and the safety-alert symbol.

## Label M165732 Warning Avoid Serious Injury



M165732a

## WARNING: AVOID INJURY from PTO

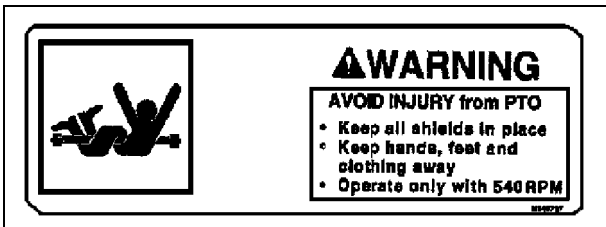

M146727

- Keep all shields in place.
- Keep hands, feet and clothing away.
- Operate only with 540 RPM.

## AVOID SERIOUS INJURY OR DEATH

- Read operator's manual
- Drive up and down slopes, not across
- Avoid sudden turns
- Add proper ballast for operating conditions and machine configuration-See operator's manual
- If machine stops going uphill, stop blade and back down slowly
- Keep safety devices (guards, shields and switches) in place and working
- Remove objects that can be thrown by blade
- When leaving machine:
  - -Stop Engine
  - -Set parking brake
  - -Remove key

## Label M165732 Danger Rotating Blades



M165732a

## DANGER ROTATING BLADES

- Do not mow when children or others are around
- Do not mow in reverse
- Look down and behind before and while backing
- Never carry children even with blades off

# Safety Labels

## Prevent Equipment Fires

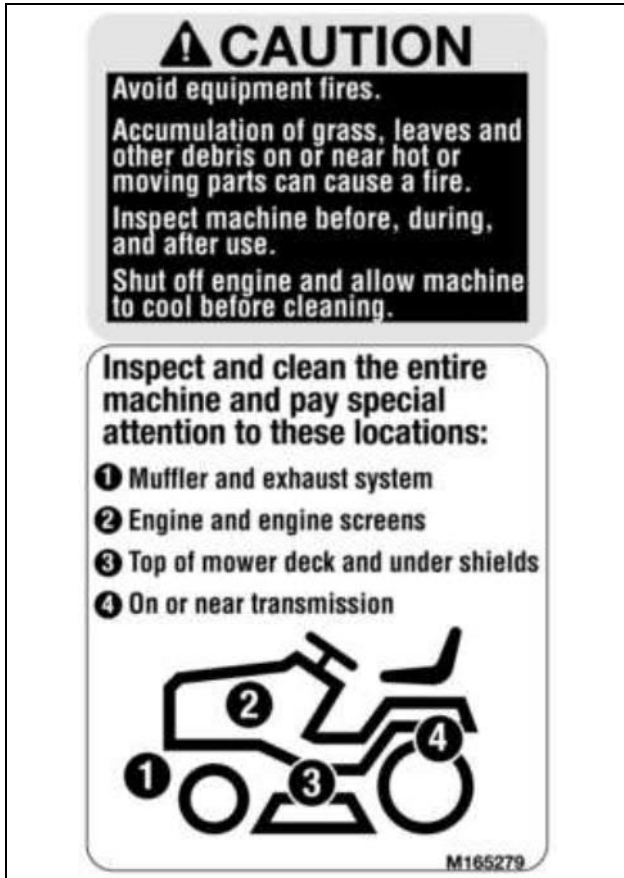

M165279

- Avoid equipment fires.
- Accumulation of grass, leaves and other debris on or near hot or moving parts can cause a fire.
- Inspect machine before, during, and after use.
- Shut off engine and allow machine to cool before cleaning.

### Inspect and clean the entire machine and pay special attention to these locations:

1. Muffler and exhaust system
2. Engine and engine screens
3. Top of mower deck and under shields
4. On or near transmission

## CAUTION

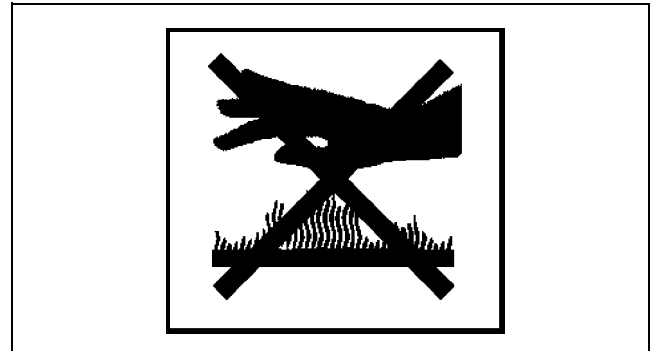

MIF

Picture Note: Molded onto muffler.

### No-text warning: Hot Surface.

- Do not touch engine muffler, it may be hot.

## DANGER: POISON

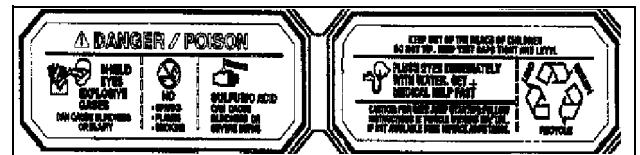

MX13578

- Shield eyes, explosive gases can cause blindness or injury.
- No sparks, flames, smoking.
- Sulfuric acid can cause blindness or severe burns.
- Keep out of the reach of children.
- Do not tip.
- Keep vent caps tight and level.
- Flush eyes immediately with water. Get medical help fast.

## M167292 Read Operator's Manual

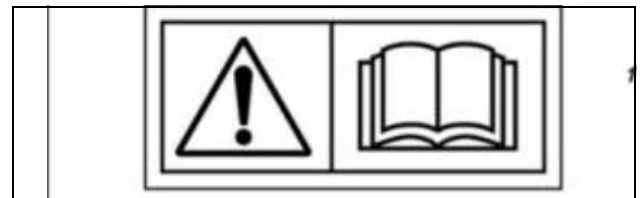

M167292a

### READ OPERATOR'S MANUAL

- This operator's manual contains important information necessary for safe machine operation.

# Safety Labels

- Carefully read operator's manual before operating machine.
- Observe all safety rules to avoid accidents.

## M167292 Keep Children Away

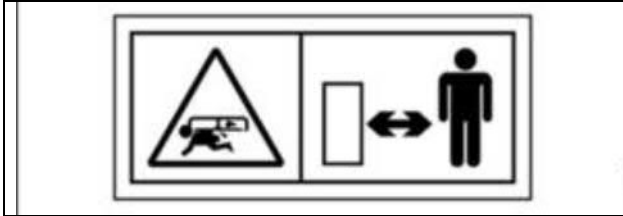

M167292a

### KEEP CHILDREN AWAY FROM MOWER

- Mower can cause dismemberment or death.
- Stay a safe distance from the machine.
- Make sure children stay clear of mower at all times when engine is running.

## M167292 Avoid Tipping

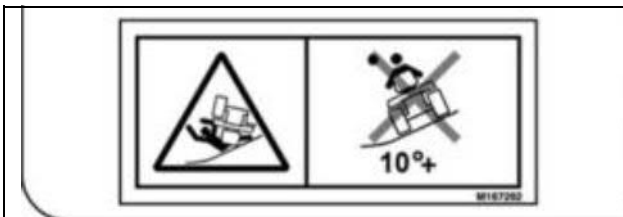

M167292a

### AVOID INJURY FROM TIPPING

- Do not drive where tractor could slip, tip, or rollover.
- In some configurations, do not drive or operate on a slope of more than 10 degrees.
- Refer to the Operating on Slopes section for more information.

## Prevent Equipment Fires

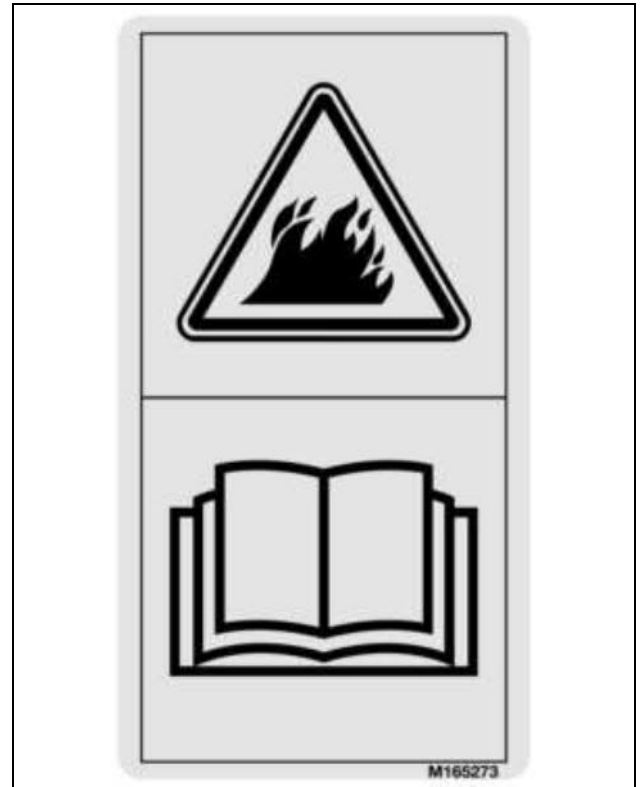

M165273

M165273

- Clean and inspect the entire machine.
- Carefully read Operator's Manual Machine Cleanout section for details.

# Safety

---



## Operating Safely

This cutting machine is capable of amputating hands and feet and throwing objects. Failure to observe the following safety instructions could result in serious injury or death.

- Read, understand and follow all instructions on the machine and in manuals provided, and view safety video, before starting. Be thoroughly familiar with the controls and the proper use of the machine before starting.
- Do not put hands or feet near rotating parts or under the machine. Keep clear of the discharge opening at all times.
- Only allow responsible adults, who are familiar with the instructions, to operate this machine. Local regulations may restrict the age of the operator.
- Clear the area of objects such as rocks, wire and toys which could be thrown by the blades.
- Be sure the area is clear of bystanders before operating. Stop machine if anyone enters the area.
- Never carry passengers.
- Do not mow in reverse unless absolutely necessary. Always look down and behind before and while backing.
- Never direct discharged material toward anyone. Avoid discharging material against a wall or obstruction. Material may ricochet back toward the operator. Stop the blades when crossing gravel surfaces.
- Do not operate the machine without the entire grasscatcher, discharge guard, or other safety devices in place and working. Never operate with the discharge deflector raised, removed, or altered, unless using a grasscatcher.
- Slow down before turning.
- Never leave a running machine unattended. Always turn off blades, lock park brake, stop engine and remove key before dismounting.
- Disengage blades when not mowing. Shut off engine and wait for all parts to come to a complete stop before cleaning the machine, removing the grasscatcher, or unclogging the discharge chute.
- Operate machine only in daylight or good artificial light.
- Do not operate the machine while under the influence of alcohol or drugs.
- Watch for traffic when operating near or crossing roadways. Stop blades before crossing roads or sidewalks.
- Use extra care when loading or unloading the machine into a trailer or truck.
- Always wear safety goggles or safety glasses with side shields when operating machine.
- Data indicates operators 60 years and above are involved

in a large percentage of riding mower-related injuries. These operators should evaluate their ability to operate the riding mower safely enough to protect themselves and others from serious injury.

- Follow the manufacturer's recommendation for wheel weights or counterweights.
- Inspect machine before you operate. Be sure hardware is tight. Repair or replace damaged, badly worn, or missing parts. Be sure guards and shields are in good condition and fastened in place. Make any necessary adjustments before you operate.
- Before using, always visually inspect to see that the blades, blade bolts and the mower assembly are not worn and damaged. Replace worn and damaged blades and bolts in sets to preserve balance.
- Make sure spark plug, muffler, fuel cap and air cleaner are in place before starting the engine.
- Be sure all drives are in neutral and parking brake is locked before starting engine. Only start engine from the operator's position.
- Do not change the engine governor settings or overspeed the engine. Operating the engine at excessive speed can increase the hazard of personal injury.
- If you hit an object or if abnormal vibration occurs, stop the machine and inspect it. Make repairs before you operate.
- Use only accessories and attachments approved by the manufacturer of the machine. Keep safety labels visible when installing accessories and attachments.
- Do not wear radio or music headphones. Safe service and operation requires your full attention.
- When machine is left unattended, stored, or parked, lower the mower deck unless a positive mechanical lock is used.

## Using a Spark Arrestor

The California Public Resources Code, section 4442.5 provides as follows:

No person shall sell, offer for sale, lease, or rent to any person any internal combustion engine subject to Section 4442 or 4443, and not subject to Section 13005 of the Health and Safety Code, unless the person provides a written notice to the purchaser or bailee, at the time of sale or at the time of entering into the lease or rental contract, stating that it is a violation of Section 4442 or 4443 to use or operate the engine on any forest-covered, brush-covered, or grass-covered land unless the engine is equipped with a spark arrestor, as defined in Section 4442, maintained in effective working order or the engine is constructed, equipped, and maintained for the prevention

# Safety

of fire pursuant to Section 4443. Cal. Pub. Res. Code 4442.5.

Other states or jurisdictions may have similar laws. A spark arrestor for your machine may be available from your authorized dealer. An installed spark arrestor must be maintained in good working order by the operator.

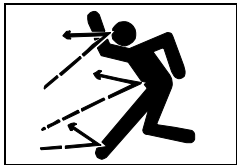

## Checking Mowing Area

- Clear mowing area of objects that might be thrown. Keep people and pets out of mowing area.
- Low-hanging branches and similar

obstacles can injure the operator or interfere with mowing operation. Before mowing, identify potential obstacles such as low-hanging branches, and trim or remove those obstacles.

- Study mowing area. Set up a safe mowing pattern. Do not mow where traction or stability is doubtful.
- Test drive area with mower lowered but not running. Slow down when you travel over rough ground.

## Parking Safely

1. Stop machine on a level surface, not on a slope.
2. Disengage mower blades or any other attachments.
3. Lower attachments to the ground.
4. Lock the park brake.
5. Stop the engine.
6. Remove the key.
7. Wait for engine and all moving parts to stop before you leave the operator's seat.
8. Close fuel shut-off valve, if your machine is equipped.
9. Disconnect the negative battery cable or remove the spark plug wire(s) (for gasoline engines) before servicing the machine.

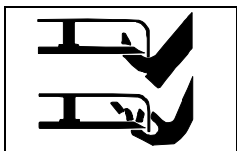

## Rotating Blades are Dangerous

**HELP PREVENT SERIOUS OR FATAL ACCIDENTS:**

- Rotating blades can cut off arms and legs, and throw objects. Failure to observe safety instructions could result in serious injury or death.
- Keep hands, feet and clothing away from mower deck

when engine is running.

- Be alert at all times, drive forward and in reverse carefully. People, especially children can move quickly into the mowing area before you know it.
- Before backing up, stop mower blades or attachments and look down and behind the machine carefully, especially for children.
- Do not mow in reverse.
- Shut off blades when you are not mowing.
- Park machine safely before leaving the operator's station for any reason including emptying the grasscatchers or unplugging the chute.
- The mower blades should stop in approximately five seconds when the mower is disengaged. If you believe that your blades may not be stopping in that period of time, take your machine to your authorized dealer where they can safely check and service your machine.

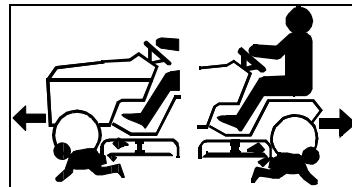

## Protect Children

- Death or serious injury can occur when young children associate having fun with a lawn mowing machine simply because

someone has given them a ride on a machine.

- Children are attracted to lawn mowing machines and mowing activities. They don't understand the dangers of rotating blades or the fact that the operator is unaware of their presence.
- Children who have been given rides in the past may suddenly appear in the mowing area for another ride and be run over or backed over by the machine.
- Tragic accidents with children can occur if the operator is not alert to the presence of children, especially when a child approaches a machine from behind. Before and while backing up, stop mower blades and look down and behind the machine carefully, especially for children.
- Never carry children on a machine or attachment, even with the blades off. Do not tow children in a cart or trailer. They can fall off and be seriously injured or interfere with safe machine operation.
- Never use the machine as a recreational vehicle or to entertain children.
- Never allow children or an untrained person operate the machine. Instruct all operators not to give children a ride on the machine or in an attachment.
- Keep children indoors, out of the mowing area, and in the watchful eye of a responsible adult, other than the operator,

# Safety

---

when a mower is being operated.

- Stay alert to the presence of children. Never assume that children will remain where you last saw them. Turn the machine off if a child enters the work area.
- Use extreme care when approaching blind corners, shrubs, trees, or other objects that may block your view of a child.

## Operating on Slopes

**NOTE: Make a photocopy of this page and cut out angle chart (A) to use for measuring slope angle.**

- Slopes are a major factor related to loss-of-control and tipover accidents, which can result in severe injury or death. Operation on all slopes requires extra caution.

### Identify Slopes for Safe Operation

- Follow safe procedures for operation on slopes. Measure slopes of all mowing sites to determine which slopes are safe for mowing with a ride-on mower. Always use common sense and good judgement when performing this survey.

### Measuring Slopes

- Suggested Method 1: Lay a straight piece of sturdy lumber 1.2 m (4 ft) long on the slope and measure the angle of the slope with an angle indicator or protractor level.
- Suggested Method 2: Refer to the slope gauge provided with this manual.

### Operate Safely on Slopes

- Exceeding the recommended maximum slope angle increases the risk of rollover accidents that can result in serious injury or death.
- Never mow or operate ride-on mower on slope angles greater than 18° with the lawn ride-on mower in its basic configuration. The basic configuration is the ride-on mower with mower deck and not other attachments. (A 18° slope is a slope that rises 1.98 m (6.5 ft) over a horizontal distance of 6.1 m (20 ft).)
- When using attachments, never mow or operate the ride-on mower on slope angles greater than 10°. The addition of a weather enclosure, material collection system, or other attachments will increase the risk of a rollover. (A 10° slope is a slope that rises 1 m (3.5 ft) over a horizontal distance of 6.1 m (20 ft).)
- On slope angles of 10° or less, the risk of rollover is low, but as the slope angle increases to the recommended maximum, the risk increases to a medium level.
- Always consider potential turf conditions and slope angles when determining the risk of loss-of-control and tip-over accidents.

- Drive slowly when mowing or operating on slopes.
- If you feel uneasy on a hillside, do not mow or operate on it.
- Mow up and down slopes, not across.
- Watch for holes, ruts, bumps, rocks, or other hidden objects. Uneven terrain could overturn the ride-on mower. Tall grass can hide obstacles.
- Drive slowly so you will not have to stop while on a slope.
- Do not mow on wet grass. Tires may lose traction. Tires may slip on slopes even though the brakes are functioning properly.
- Avoid starting, stopping or turning on a slope. If the tires lose traction, disengage the PTO and proceed slowly, straight down the slope.
- Keep all movement on slopes slow and gradual. Do not make sudden changes in speed or direction, which could cause the ride-on mower to roll over.

# Safety

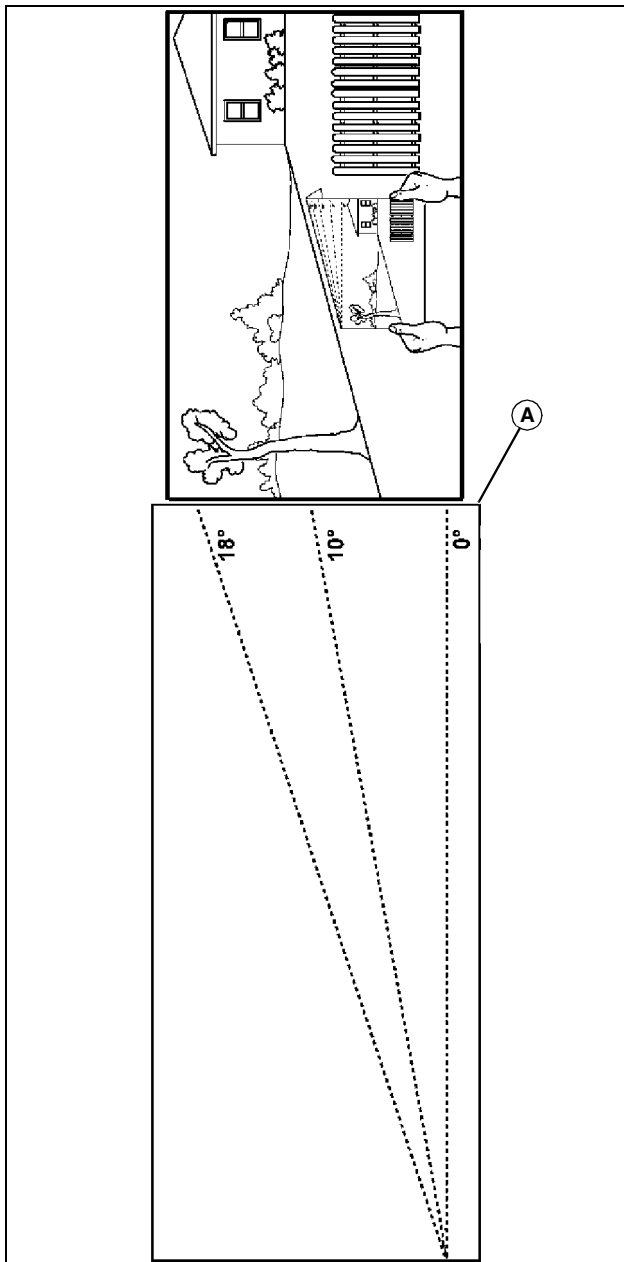

MX51797

## Operating Near Hazards

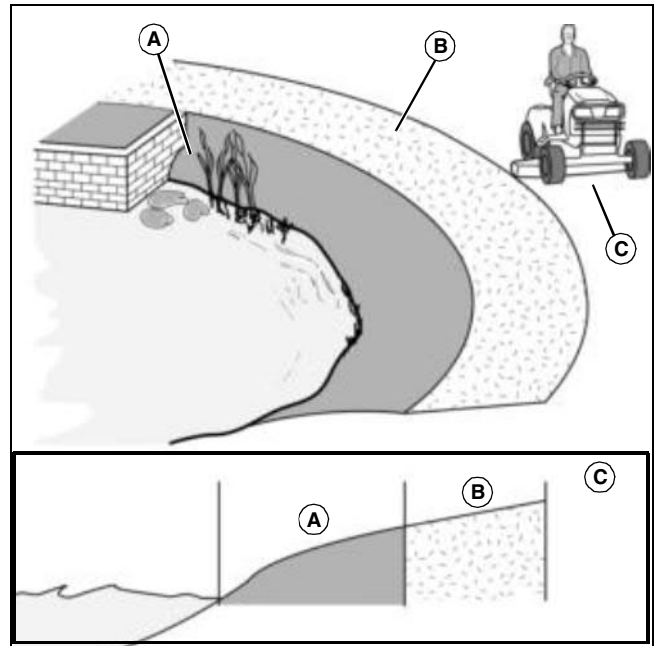

MX51888

### Picture Note: Example side view of slope and hazards, showing areas (A), (B), and (C).

- Do not mow or operate machine in areas adjacent to hazards that may cause the machine to roll over. The machine could suddenly lose traction, slide, and/or roll over if a wheel goes over the edge or if the edge breaks away.
- Hazards (A) include but are not limited to:
  - Drop-offs, ditches, embankments, or bodies of water.
  - Areas of unsafe slope, soft ground, edges along bodies of water, or area with holes, ruts, bumps, or other hidden objects.
- Maintain a buffer area (B) at least as wide as the machine between hazards (A) and the mowing area (C). Do not mow or operate the machine in the hazard area or buffer area.
- Only mow or operate the machine in the mowing area (C). Do not exceed the recommended slope operating angle. Refer to the "Operate Safely on Slopes" section.
- Use a walk-behind mower or string trimmer in and around areas (A) and (B).



### Keep Riders Off

- Only allow the operator on the machine. Keep riders off.
- Riders on the machine or attachment may be struck by foreign objects or thrown off the machine causing serious injury.



**Suggest:**

**If the above button click is invalid.**

**Please download this document**

**first, and then click the above link**

**to download the complete manual.**

**Thank you so much for reading**

# Safety

- Riders obstruct the operator's view resulting in the machine being operated in an unsafe manner.



## Stay Clear of Rotating Drivelines

Entanglement in rotating driveline can cause serious injury or death.

- Wear close fitting clothing.
- Stop the engine and be sure PTO driveline is stopped before getting near it.

## Checking Wheel Hardware

- A serious accident could occur causing serious injury if wheel hardware is not tight.
- Check wheel hardware tightness often during the first 100 hours of operation.
- Wheel hardware must be tightened to specified torque using the proper procedure anytime it is loosened.

## Towing Loads Safely

- Stopping distance increases with speed and weight of towed load. Travel slowly and allow extra time and distance to stop.
- Total towed weight must not exceed combined weight of pulling machine, ballast and operator. Use counterweights or wheel weights as described in the attachment or pulling machine operator's manual.
- Excessive towed load can cause loss of traction and loss of control on slopes. Reduce towed weight when operating on slopes.
- Never allow children or others in or on towed equipment.
- Use only approved hitches. Tow only with a machine that has a hitch designed for towing. Do not attach towed equipment except at the approved hitch point.
- Follow the manufacturer's recommendations for weight limits for towed equipment and towing on slopes.
- Towed attachments will increase the risk of rollover. Refer to the "Operating on Slopes" section for more information.
- Do not turn sharply. Use additional caution when turning or operating under adverse surface conditions. Use care when reversing.
- Do not shift to neutral and coast downhill.

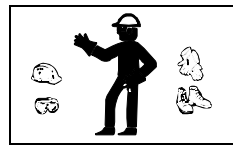

## Wear Appropriate Clothing

- Always wear eye protection when operating the machine.
- Wear close fitting clothing and safety equipment appropriate for the job.
- While operating this machine, always wear substantial footwear and long trousers. Do not operate the equipment when barefoot or wearing open sandals.
- Wear a suitable protective device such as earplugs. Loud noise can cause impairment or loss of hearing.

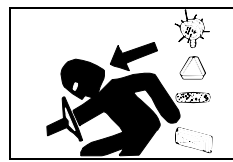

## Driving Safely on Public Roads

Avoid personal injury or death resulting from a collision with another vehicle on public roads:

- Use safety lights and devices. Slow moving machines when driven on public roads are hard to see, especially at night.
- Whenever driving on public roads, use flashing warning lights and turn signals according to local regulations. Extra flashing warning lights may need to be installed.



## Practice Safe Maintenance

- Only qualified, trained adults should service this machine. Understand service procedure before doing work.
- Never operate machine in a closed area where dangerous carbon monoxide fumes can collect.
- Keep all nuts and bolts tight, especially blade attachment bolts, to be sure the equipment is in safe working condition.
- Never tamper with safety devices. Check their proper operation regularly.
- Keep machine free of grass, leaves or other debris build-up. Clean up oil or fuel spillage and remove any fuel-soaked debris. Allow the machine to cool before storing.
- If you strike a foreign object, stop and inspect the machine. Repair, if necessary, before restarting.
- Never make any adjustments or repairs with the engine running. Wait for all movement to stop on machine before adjusting, cleaning or repairing.
- Check grasscatcher components and the discharge guard frequently and replace with manufacturer's recommended parts, when necessary. Grasscatcher components are subject to wear, damage, and deterioration which could

**<https://www.ebooklibonline.com>**

Hello dear friend!

Thank you very much for reading.

Enter the link into your browser.

The full manual is available for immediate download.

**<https://www.ebooklibonline.com>**