

TRS 21 Snowthrower

(Serial No. 160,001 –)

OPERATOR'S MANUAL

**John Deere
Lawn & Grounds Care Division
OMM127510 E6**

**North American Version
Litho in U.S.A
English**

TABLE OF CONTENTS

	Page
Safety Signs	1
Controls	3
Operating	5
Replacement Parts	14
Service Machine Safely	15
Service	17
Troubleshooting	29
Storing Machine	31
Assembly	33
Specifications	34
Index	36
John Deere Service Literature	39

All information, illustrations and specifications in this manual are based on the latest information at the time of publication. The right is reserved to make changes at any time without notice.

COPYRIGHT© 1996
John Deere Horicon Works
All rights reserved
Previous Editions
COPYRIGHT© 1991, 1990, 1989

<https://www.ebooklibonline.com>

Hello dear friend!

Thank you very much for reading.

Enter the link into your browser.

The full manual is available for immediate download.

<https://www.ebooklibonline.com>

SAFETY SIGNS

Safety-Alert Symbol

Read and recognize safety information. Be alert to the potential for personal injury when you see this safety-alert symbol.

On your machine safety labels, the words DANGER, WARNING, and CAUTION are used with this safety-alert symbol. DANGER identifies the most serious hazards. In this manual, the word CAUTION and this symbol call attention to safety messages.



Machine Safety Labels

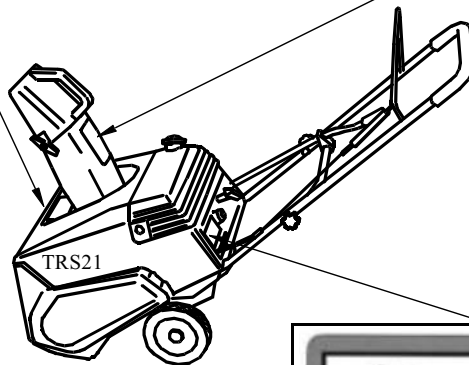

SAFETY SIGNS

Certification Labels

This OPEI label on your snow thrower indicates that this model has been certified by an independent laboratory for compliance with American National Standard B-71.3-1995, "Safety Specifications" for Snowthrowers.

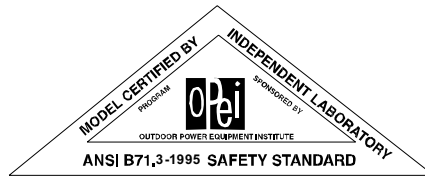

CONTROLS

Engine Controls

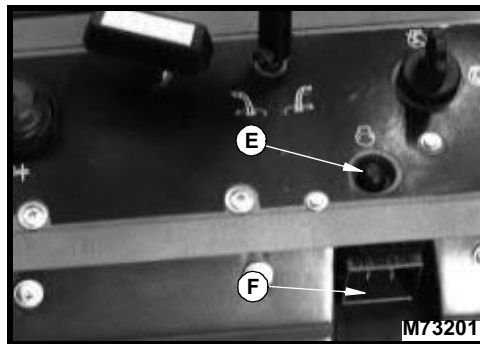
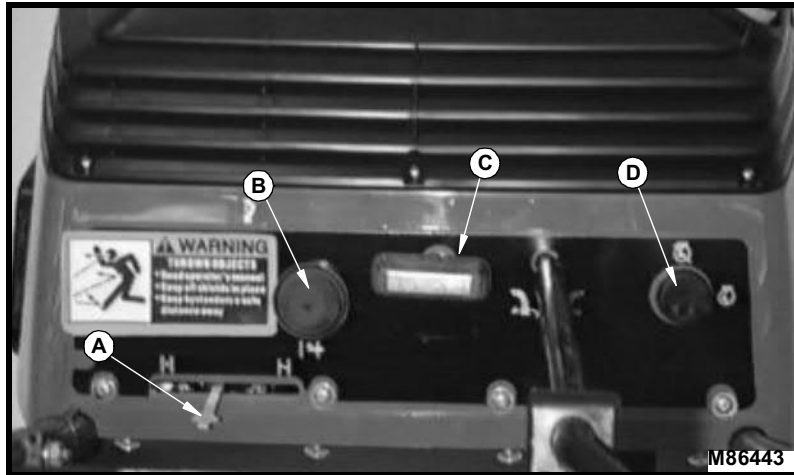

- A - Choke LeverChokes engine for starting
- B - Primer BulbPrimes engine for starting
- C - Starter HandlePull to start engine
- D - Key SwitchSets engine to start
- E - Starter Button for Electric Start Model
.....Push to start engine
- F - Power Cord Receptacle for Electric Start Model
.....Insert plug for electrical start

CONTROLS

Handle and Spout Controls

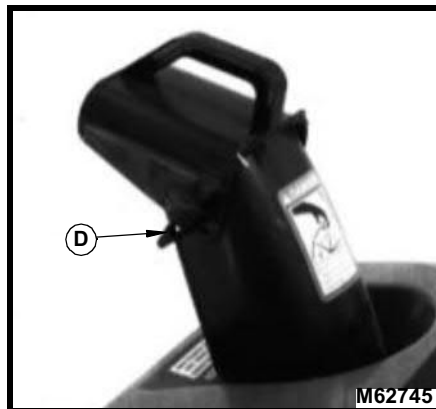
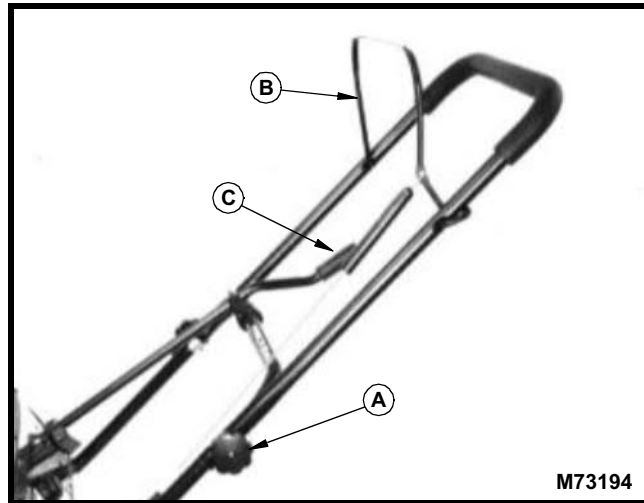

- A - Handle KnobsTightens handle assembly
- B - Auger Bail Engages auger
- C - Chute Crank.....Adjusts chute direction
- D - Spout Control KnobAdjusts spout direction

OPERATING

SAFETY

Operate Safely



- Inspect machine before you operate. Be sure hardware is tight. Repair or replace damaged, badly worn, or missing parts. Be sure all shields and guards are in good condition and fastened in place. Make any necessary adjustments before you operate.
- Clear work area of objects that might be thrown. Keep people and pets out of the work area. Keep children in the house when you are operating the snowthrower. Stop machine if anyone enters the area.
- If you hit an object, stop the machine and inspect it. Make repairs before you operate. Keep machine properly maintained, clean, and in good working order.
- DO NOT throw snow toward people, cars, or buildings.
- DO NOT use snowthrower on surfaces above ground level, such as, a roof of a building.
- Be extremely careful if you must clear snow from a gravel path. Be aware that snowthrower may pick up gravel in snow. Adjust spout angle carefully to throw this snow safely.
- DO NOT leave machine unattended when it is running.
- Only operate during daylight or with good artificial light.
- Be sure of footing. Operate slowly on slippery surfaces. Be especially careful when you pull machine backwards with the engine running. Avoid holes, rocks, roots, etc.
- DO NOT throw snow across a slope. Be very careful when you change direction on a slope. Do not try to clear snow from a steep slope. Keep away from edge of a ditch or bank.
- Keep a firm hold on the machine handles. Avoid sudden starts and stops.
- DO NOT run engine in a building unless there is good ventilation.

OPERATING

Rotating Blades are Dangerous - Protect Children and Prevent Accidents



PROTECT CHILDREN:

- Never assume that children will remain where you last saw them. Stay alert to the presence of children.
- Keep children in the house when you are operating the machine.
- Turn machine off if a child enters the area.
- Use extra care when you come to blind corners, shrubs, trees, or other objects that may block your vision.
- DO NOT let children or an untrained person operate the machine.

HELP PREVENT SERIOUS OR FATAL ACCIDENTS:

- Be alert at all times, people especially children can move quickly into the area before you know it.
- DO NOT operate snowthrower if you are under the influence of drugs or alcohol.
- Keep hands, feet, and clothing away from discharge chute and auger.

Wear Appropriate Clothing



- Wear close fitting clothing and safety equipment appropriate for the job.
- Wear eye protection.
- Loud noise can cause impairment or loss of hearing, wear a suitable protective device such as earplugs.
- Do not wear radio or music headphones while operating the machine. Safe operation requires your full attention.

OPERATING

DAILY OPERATING CHECKLIST

- ✓ Check fuel level
- ✓ Check hardware
- ✓ Inspect snowthrower

Avoid Damage to Plastic and Painted Surfaces

- Be careful not to spill fuel on the snowthrower. The fuel may damage surface. Wipe up spilled fuel immediately.

Snowthrowing Tips

Clear snow immediately after it falls, if possible.

Overlap each swath slightly for complete snow removal.

Run engine at FAST speed for best snowthrower performance.

Throw snow down wind, if possible.

Wear eye protection.

For deep or wet snow:

- Let the snowthrower go at its own pace.
- If snow does not flow freely, stop or back up to clear the snowthrower.

After you finish snowthrowing:

- STOP the engine.
- Clean the snowthrower. Wipe it dry.
- Park and run the snowthrower a few minutes to help prevent moving parts from freezing.
- Do not leave the snowthrower unattended with the engine running.
- Do not cover the snowthrower if the engine is warm.

OPERATING

Adjusting the Chute

Turn the crank (A) to throw snow in the desired direction.

The chute will turn 90° to the left or right.

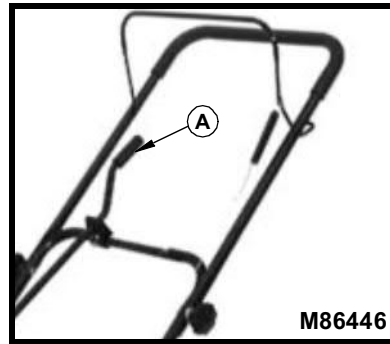

Adjusting the Spout



CAUTION: DO NOT adjust the spout while the auger is ENGAGED.



1. Loosen the knob (A).
2. Move the spout to the desired position.
3. Tighten the knob.

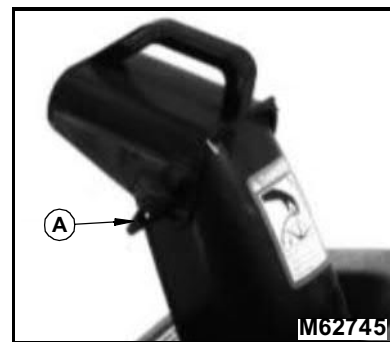

OPERATING

Manual Starting

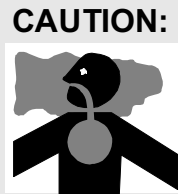

CAUTION: Engine exhaust fumes can cause sickness or death.
DO NOT start the engine in an enclosed area.

IMPORTANT: For operation above 2134 m (7000 ft), install the High Altitude Carburetor Kit. See your John Deere dealer for this kit.

1. Turn the key to the ON position (A).
2. FOR A COLD ENGINE:
Move the choke lever (B) to the CLOSED position.
FOR A WARM ENGINE:
Move the choke lever (B) to the OPEN position. **DO NOT** push the primer bulb.

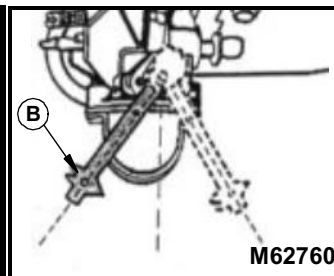
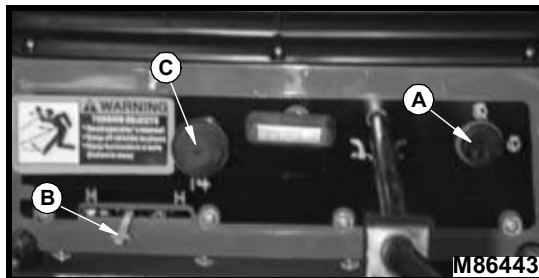

IMPORTANT:

- Cover the vent hole with your finger when you push the primer bulb (C).
- To prevent flooding, **DO NOT** over prime.

3. For temperatures ABOVE -12°C (15°F): Push the bulb (C) twice.
For temperatures BELOW -12°C (15°F): Push the bulb (C) four times.



Suggest:

If the above button click is invalid.

Please download this document

first, and then click the above link

to download the complete manual.

Thank you so much for reading

OPERATING

IMPORTANT: •DO NOT jerk the handle (D) or let it snap back: you may damage the rope or starter.
•To prevent flooding, DO NOT over prime.

4. Pull the starter handle (D) fast and steady.

5. If the engine does not start: Push the primer bulb twice and pull the handle until the engine starts.

6. If the engine fires but does not run, do not choke it:

- Pull the handle until the engine starts.
- Repeat steps 2, 3 and 4 if necessary.

7. When the engine starts:

- Slowly move the choke lever to the OPEN position.
- Warm the engine briefly before you operate the snowthrower.
- The engine will run at FULL THROTTLE.

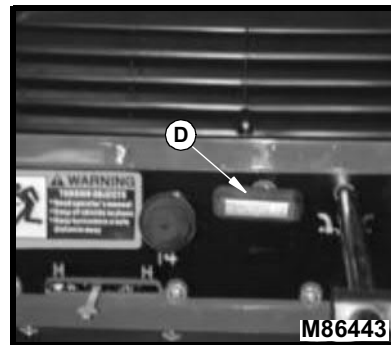

NOTE: To STOP the engine, turn the key to the OFF position.

<https://www.ebooklibonline.com>

Hello dear friend!

Thank you very much for reading.

Enter the link into your browser.

The full manual is available for immediate download.

<https://www.ebooklibonline.com>