

**JOHN DEERE**  
**AG & TURF DIVISION**

---

**John Deere Select Series™**  
**X300 Tractors**

OMM164737 G1

**OPERATOR'S MANUAL**



**JOHN DEERE**

**⚠ WARNING:** The Engine Exhaust from this product contains chemicals known to the State of California to cause cancer, birth defects or other reproductive harm.

California Proposition 65 Warning

North American Version  
Printed in U.S.A.

# Introduction

---

## Thank You for Purchasing a John Deere Product

We appreciate having you as a customer and wish you many years of safe and satisfied use of your machine.

## Using Your Operator's Manual

This manual is an important part of your machine and should remain with the machine when you sell it.

Reading your operator's manual will help you and others avoid personal injury or damage to the machine. Information given in this manual will provide the operator with the safest and most effective use of the machine. Knowing how to operate this machine safely and correctly will allow you to train others who may operate this machine.

If you have an attachment, use the safety and operating information in the attachment operator's manual along with the machine operator's manual to operate the attachment safely and correctly.

This manual and safety signs on your machine may also be available in other languages (see your authorized dealer to order).

Sections in your operator's manual are placed in a specific order to help you understand all the safety messages and learn the controls so you can operate this machine safely. You can also use this manual to answer any specific operating or servicing questions. A convenient index located at the end of this book will help you to find needed information quickly.

The machine shown in this manual may differ slightly from your machine, but will be similar enough to help you understand our instructions.

RIGHT-HAND and LEFT-HAND sides are determined by facing in the direction the machine will travel when going forward. When you see a broken line (-----), the item referred to is hidden from view.

Before delivering this machine, your dealer performed a predelivery inspection to ensure best performance.

## Special Messages

Your manual contains special messages to bring attention to potential safety concerns, machine damage as well as helpful operating and servicing information. Please read all the information carefully to avoid injury and machine damage.



**CAUTION: Avoid injury! This symbol and text highlight potential hazards or death to the operator or bystanders that may occur if the hazards or procedures are ignored.**

**IMPORTANT: Avoid damage! This text is used to tell the operator of actions or conditions that might result in damage to the machine.**

***NOTE: General information is given throughout the manual that may help the operator in the operation or service of the machine.***

## Attachments for Your Machine

There's a John Deere attachment or kit to make your new machine perform more tasks or be more versatile, whether your machine is a lawn tractor or compact utility tractor or a utility vehicle.

You can check out the entire line of attachments for your machine at [JohnDeere.com](http://JohnDeere.com) or ask your John Deere dealer. From aerators to electric lift kits to tillers, there's a John Deere attachment or kit to fill every need.

# Product Identification

---

## Record Identification Numbers

### John Deere Select Series™ - X300 Tractors

PIN (220001-)

If you need to contact an Authorized Service Center for information on servicing, always provide the product model and identification numbers.

You will need to locate the model and serial number for the machine and for the engine of your machine and record the information in the spaces provided below.

DATE OF PURCHASE:

\_\_\_\_\_

DEALER NAME:

\_\_\_\_\_

DEALER PHONE:

\_\_\_\_\_

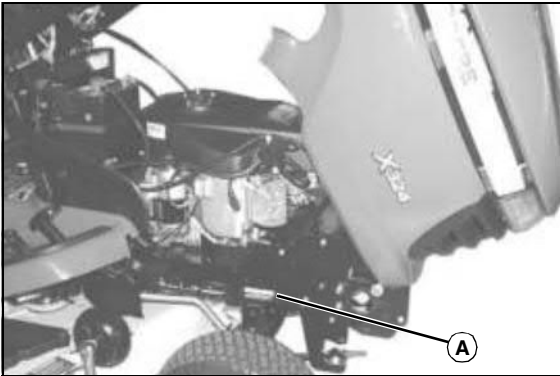

MX36205

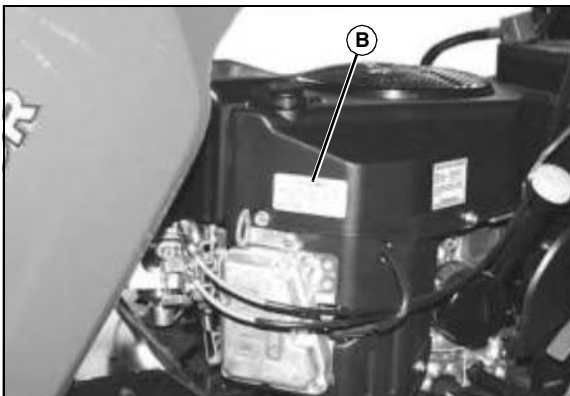

MX43928

PRODUCT IDENTIFICATION NUMBER (A):

-----

ENGINE SERIAL NUMBER (B):

-----

**<https://www.ebooklibonline.com>**

Hello dear friend!

Thank you very much for reading.

Enter the link into your browser.

The full manual is available for immediate download.

**<https://www.ebooklibonline.com>**

# Table of Contents

---

Safety Labels .....	1
Safety .....	8
Machine Cleanout.....	14
Operating - Controls .....	17
Operating.....	18
Replacement Parts .....	33
Service Intervals .....	34
Service Lubrication.....	35
Service Engine .....	38
Service Transmission .....	44
Service Mower.....	47
Service Electrical.....	62
Service Miscellaneous.....	65
Troubleshooting .....	69
Storage .....	73
Assembly .....	75
Specifications .....	78
Warranty .....	83
Index.....	85

Original Instruction

All information, illustrations and specifications in this manual are based on the latest information at the time of publication. The right is reserved to make changes at any time without notice.

COPYRIGHT© 2011

Deere & Co.

John Deere Ag & Turf Division

All rights reserved

Previous Editions

COPYRIGHT© 2009, 2010

OMM164737 G1 - English

# Safety Labels

## Safety Label Location

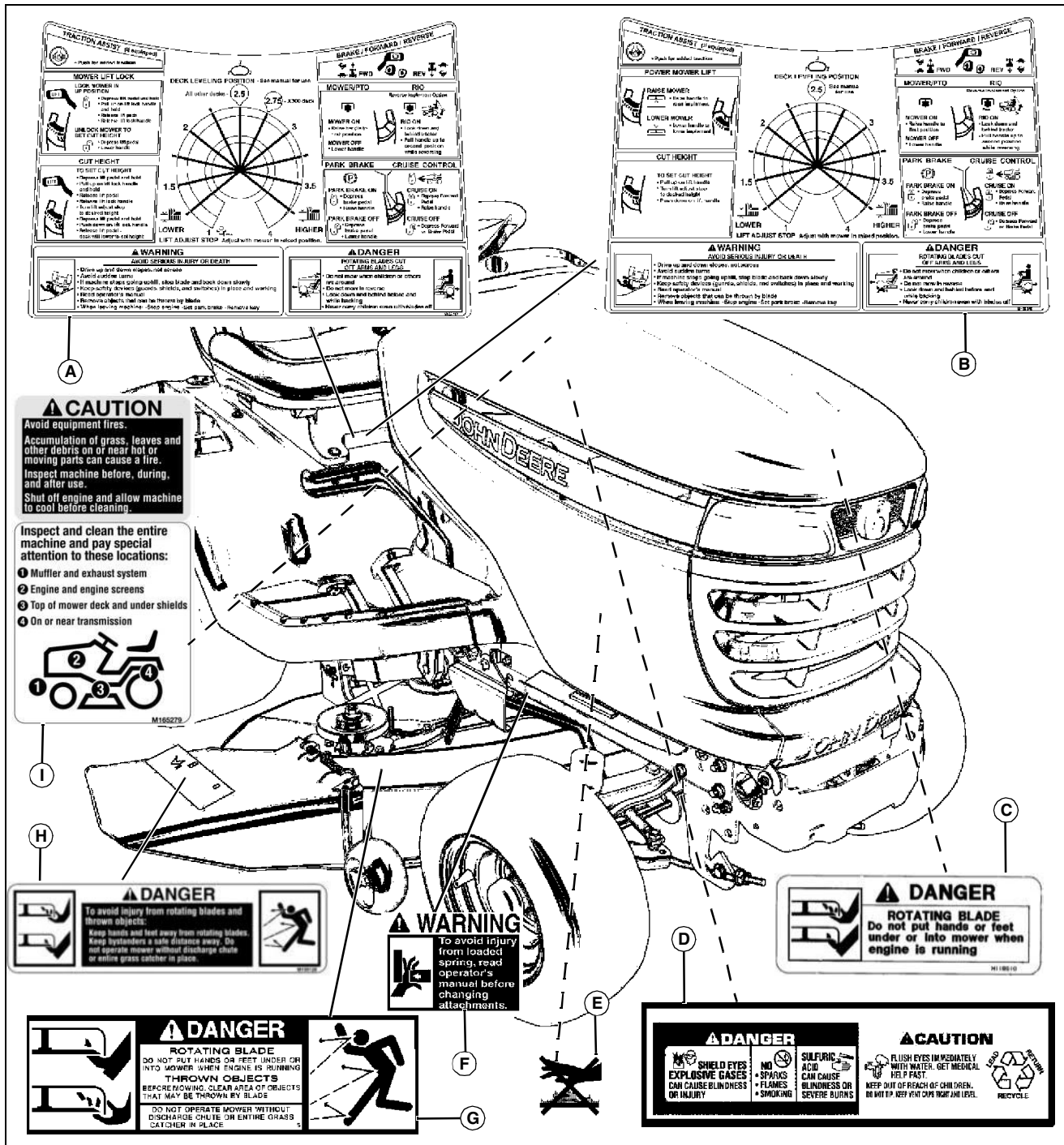

- A - DANGER/WARNING M162713 (X300 - X324)
- B - DANGER/WARNING M164702 (X310, X360)
- C - DANGER M118610
- D - DANGER M128699 (ON BATTERY)
- E - CAUTION (MOLDED INTO MUFFLER)
- F - WARNING M146577
- G - DANGER M89504
- H - DANGER M139128
- I - CAUTION M165279

Picture Note: Use label number listed in table below to locate complete text of safety label message following this illustration.

# Safety Labels

## Pictorial Safety Label Location

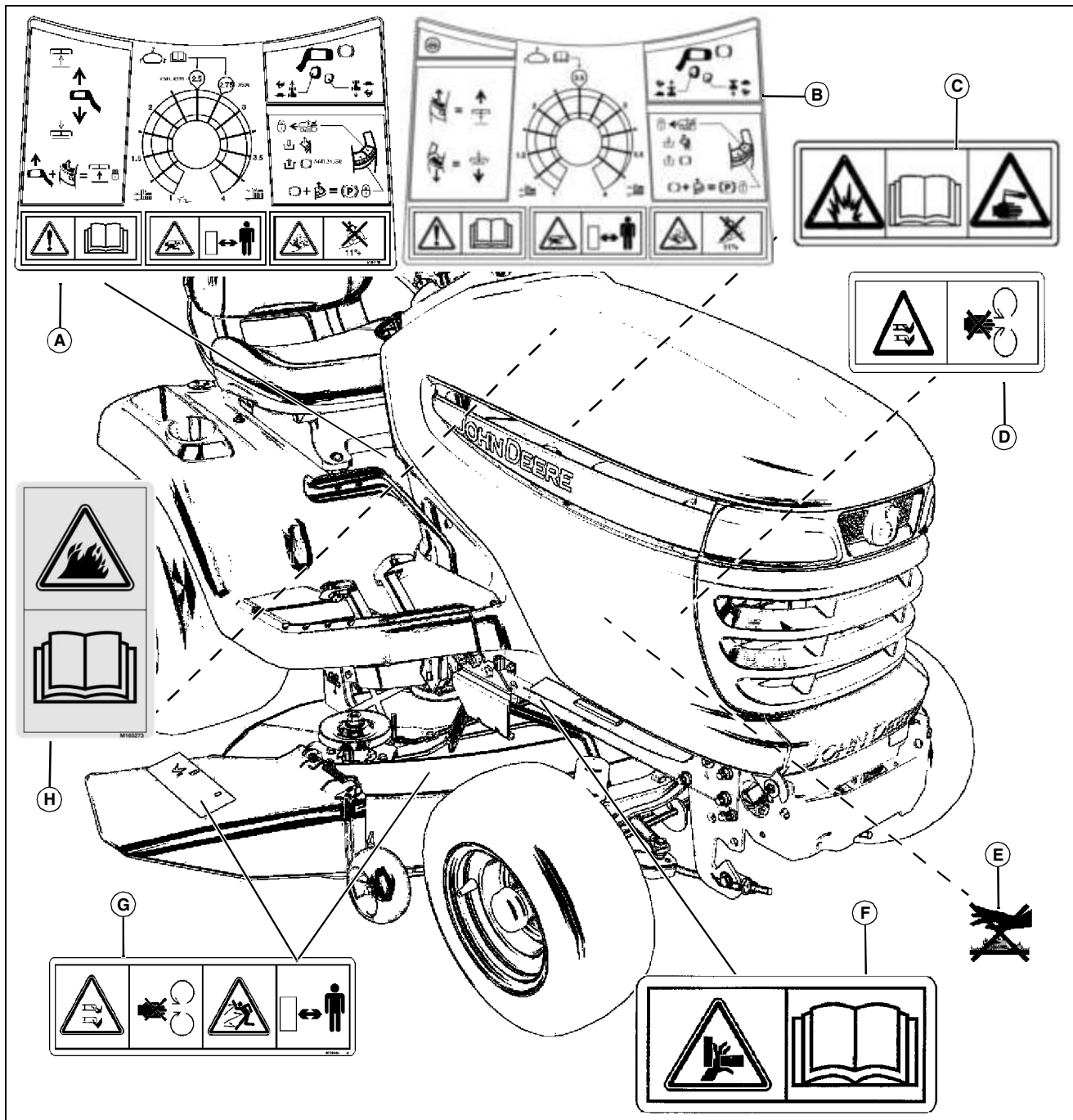

MX42023

**Picture Note:** Use label number listed in table below to locate complete text of safety label message following this illustration.

Pictorial labels are required for certain parts of the world. Your machine may not be equipped with these labels.

**A - DANGER/WARNING M162714 (X300 - X324)**

**B - DANGER/WARNING M154540 (X310, X360)**

**C - DANGER M133159 (ON BATTERY)**

**D - WARNING M118041**

**E - CAUTION (MOLDED INTO MUFFLER)**

**F - WARNING M133166**

**G - DANGER M118040**

**H - CAUTION M165273**

# Safety Labels



## Understanding The Machine Safety Labels

The machine safety labels shown in this section are placed in important areas on your machine to draw attention to potential safety hazards.

On your machine safety labels, the words DANGER, WARNING, and CAUTION are used with this safety-alert symbol. DANGER identifies the most serious hazards.

The operator's manual also explains any potential safety hazards whenever necessary in special safety messages that are identified with the word, CAUTION, and the safety-alert symbol.

There can be additional safety information contained on parts and components sourced from suppliers that is not reproduced in this operator's manual.

## DANGER

### ROTATING BLADES CUT OFF ARMS AND LEGS



M152348, M162713

- Do not mow when children or others are around.
- Do not mow in reverse.
- Look down and behind before and while backing.
- Never carry children even with blades off.

## DANGER - M89504

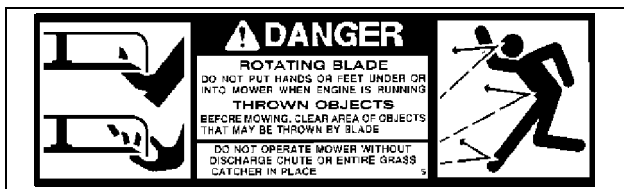

M89504

### ROTATING BLADE

- Do not put hands or feet under or into mower when engine is running.

## THROWN OBJECTS

- Before mowing, clear area of objects that may be thrown by blade.
- Do not operate mower without discharge chute or entire grass catcher in place.

## DANGER M139128



M139128

### To avoid injury from rotating blades and thrown objects:

- Keep hands and feet away from rotating blades.
- Keep bystanders a safe distance away. Do not operate mower without discharge chute or entire grass catcher in place.

## DANGER



M118610

### ROTATING BLADE

- Do not put hands or feet under or into mower when engine is running.

## DANGER M154540

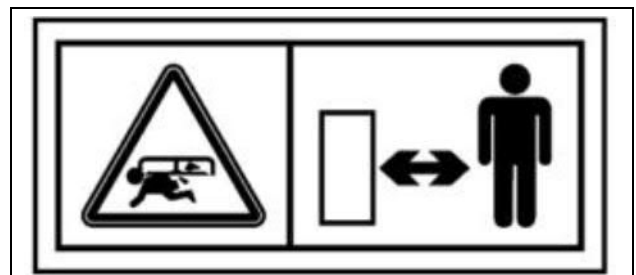

M154540

# Safety Labels

- Make sure that children stay clear of mower at all times when the engine is running.
- Stay a safe distance from the machine.

## DANGER M128699



M128699

### Picture Note: Located on battery

- Shield eyes, explosive gases can cause blindness or injury.
- No sparks, flames, smoking.
- Sulfuric acid can cause blindness or severe burns.
- Flush eyes immediately with water. Get medical help fast.
- Keep out of reach of children.
- Do not tip.
- Keep vent caps tight and level.

## WARNING

To avoid injury from loaded spring



M146577

- To avoid injury from loaded spring, read operator's manual before changing attachments.

## WARNING

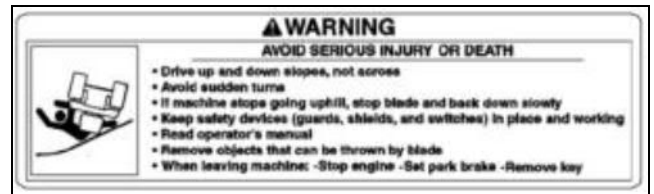

M152348, M162713

### AVOID SERIOUS INJURY OR DEATH

- Drive up and down slopes, not across.
- Avoid sudden turns.
- If machine stops going uphill, stop blades and back down slowly.
- Keep safety devices (guards, shields, and switches) in place and working.
- Read operator's manual.
- Remove objects that could be thrown by blades.
- When leaving machine:
  - Stop engine
  - Set park brake
  - Remove key

## WARNING M154540

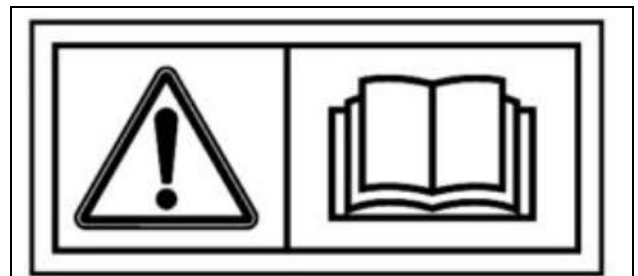

M154540

- This operator's manual contains important information necessary for safe machine operation.
- Carefully read operator's manual before operating machine. Observe all safety rules to avoid accidents.

## Safety Labels

### DANGER M162714

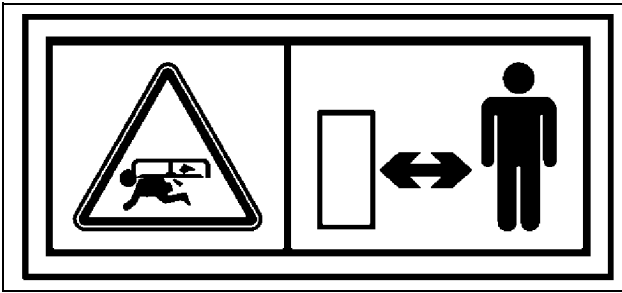

M162714

- Make sure that children stay clear of mower at all times when the engine is running.
- Stay a safe distance from the machine.

### WARNING M162714

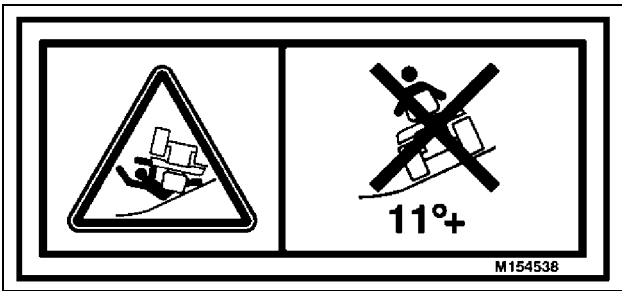

M162714

- Do not drive where machine could slip or tip. Drive up and down slopes, not across.
- Do not drive on slope with more than a 11° incline.

### WARNING M154540

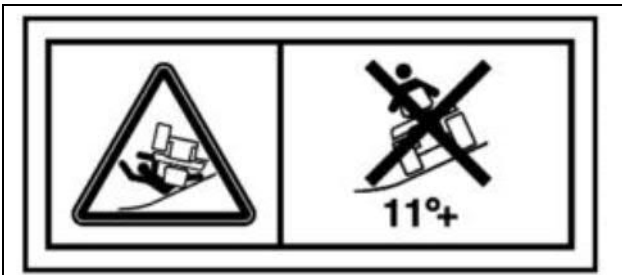

M154540

- Do not drive where machine could slip or tip. Drive up and down slopes, not across.
- Do not drive on slope with more than a 11° incline.

### Prevent Equipment Fires



M165279

- Avoid equipment fires.
- Accumulation of grass, leaves and other debris on or near hot or moving parts can cause a fire.
- Inspect machine before, during, and after use.
- Shut off engine and allow machine to cool before cleaning.

#### Inspect and clean the entire machine and pay special attention to these locations:

1. Muffler and exhaust system
2. Engine and engine screens
3. Top of mower deck and under shields
4. On or near transmission

## Safety Labels

### Avoid Injury From Rotating Blades and Thrown Objects - M118040

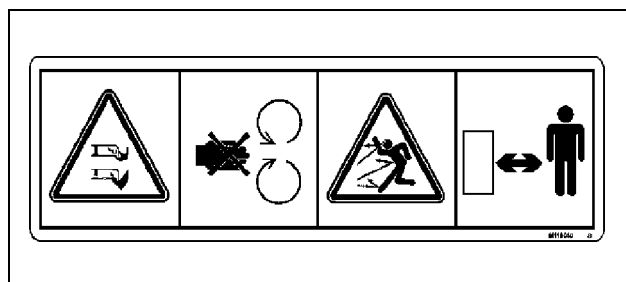

M118040

- Do not put hands or feet under or into mower when engine is running.
- Do not operate mower without discharge chute or entire grass catcher in place.
- Before mowing, clear area of objects that may be thrown by blade.
- Stay clear while engine is running.

### Avoid Injury From Rotating Blades - M118041

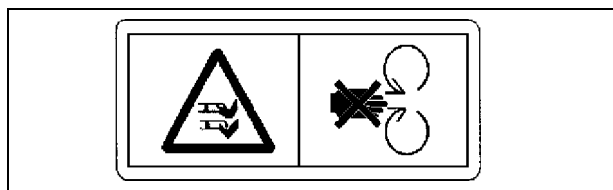

M118041

- Do not put hands or feet under or into mower when engine is running.
- Do not operate mower without discharge chute or entire grass catcher in place.

### Avoid Injury From Loaded Spring

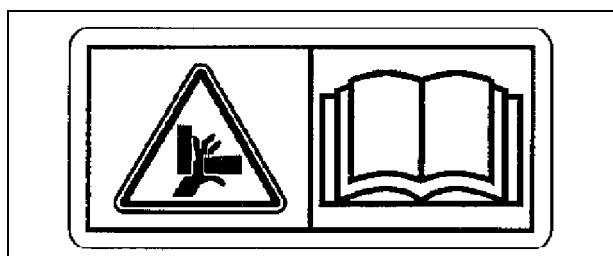

M133166

- Keep fingers and hands away from pinch point.
- To avoid injury from loaded spring, read Operator's Manual before changing attachment.

### WARNING M128484

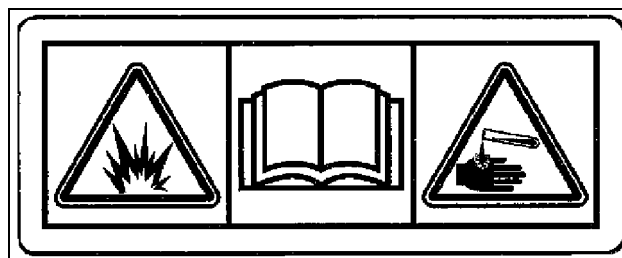

M128484

### Avoid Injury From Battery Gases and Acids

- Batteries contain explosive gases and sulfuric acid. Use extreme caution when handling battery.
- Read operator's manual for all safety information before handling battery.
- Use extreme caution when handling battery.

### Prevent Equipment Fires

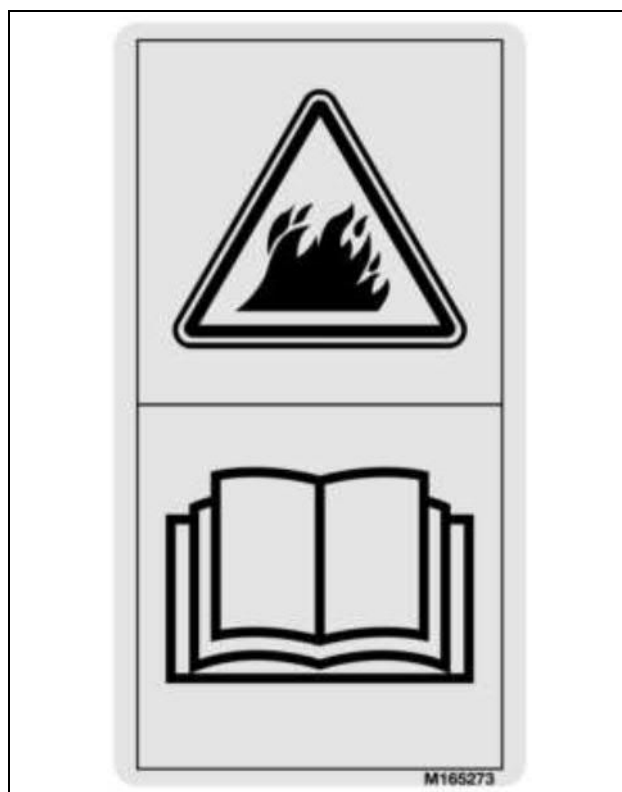

M165273

M165273

- Clean and inspect the entire machine.
- Carefully read Operator's Manual Machine Cleanout section for details.

# Safety Labels

---

## Emission Control System Certification Label

***NOTE: Tampering with emission controls and components by unauthorized personnel may result in severe fines or penalties. Emission controls and components can only be adjusted by EPA and/or CARB authorized service centers. Contact your John Deere Commercial and Consumer Equipment Retailer concerning emission controls and component questions.***

The presence of an emissions label signifies that the engine has been certified with the United States Environmental Protection Agency (EPA) and/or California Air Resources Board (CARB).

The emissions warranty applies only to those engines marketed by John Deere that have been certified by the EPA and/or CARB; and used in the United States and Canada in off-road mobile equipment.

## Emission Compliance Period

If your engine has the emission compliance category listed on the emission control system certification or air index label, this indicates the number of operating hours for which the engine has been certified to meet EPA and/or CARB emission requirements. The following table provides the engine compliance period in hours associated with the category found on the certification label.

Agency	Category	Hours
EPA	C	250
EPA	B	500
EPA	A	1000
CARB	Moderate	125
CARB	Intermediate	250
CARB	Extended	500

## Certification

Your mower has been certified for compliance with American National Standards Institute B-71.1-2003, "Safety Specifications" for Power Lawn Mowers, Lawn and Garden Tractors, and Lawn Tractors.

# Safety

---

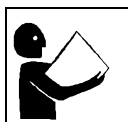

## Operating Safely

This cutting machine is capable of amputating hands and feet and throwing objects. Failure to observe the following safety instructions could result in serious injury or death.

- Read, understand and follow all instructions on the machine and in manuals provided, and view safety video, before starting. Be thoroughly familiar with the controls and the proper use of the machine before starting.
- Do not put hands or feet near rotating parts or under the machine. Keep clear of the discharge opening at all times.
- Only allow responsible adults, who are familiar with the instructions, to operate this machine. Local regulations may restrict the age of the operator.
- Clear the area of objects such as rocks, wire and toys which could be thrown by the blades.
- Be sure the area is clear of bystanders before operating. Stop machine if anyone enters the area.
- Never carry passengers.
- Do not mow in reverse unless absolutely necessary. Always look down and behind before and while backing.
- Never direct discharged material toward anyone. Avoid discharging material against a wall or obstruction. Material may ricochet back toward the operator. Stop the blades when crossing gravel surfaces.
- Do not operate the machine without the entire grasscatcher, discharge guard, or other safety devices in place and working. Never operate with the discharge deflector raised, removed, or altered, unless using a grasscatcher.
- Slow down before turning.
- Never leave a running machine unattended. Always turn off blades, lock park brake, stop engine and remove key before dismounting.
- Disengage blades when not mowing. Shut off engine and wait for all parts to come to a complete stop before cleaning the machine, removing the grasscatcher, or unclogging the discharge chute.
- Operate machine only in daylight or good artificial light.
- Do not operate the machine while under the influence of alcohol or drugs.
- Watch for traffic when operating near or crossing roadways. Stop blades before crossing roads or sidewalks.
- Use extra care when loading or unloading the machine into a trailer or truck.
- Always wear safety goggles or safety glasses with side shields when operating machine.
- Data indicates operators 60 years and above are involved

in a large percentage of riding mower-related injuries. These operators should evaluate their ability to operate the riding mower safely enough to protect themselves and others from serious injury.

- Follow the manufacturer's recommendation for wheel weights or counterweights.
- Inspect machine before you operate. Be sure hardware is tight. Repair or replace damaged, badly worn, or missing parts. Be sure guards and shields are in good condition and fastened in place. Make any necessary adjustments before you operate.
- Before using, always visually inspect to see that the blades, blade bolts and the mower assembly are not worn and damaged. Replace worn and damaged blades and bolts in sets to preserve balance.
- Make sure spark plug, muffler, fuel cap and air cleaner are in place before starting the engine.
- Be sure all drives are in neutral and parking brake is locked before starting engine. Only start engine from the operator's position.
- Do not change the engine governor settings or overspeed the engine. Operating the engine at excessive speed can increase the hazard of personal injury.
- If you hit an object or if abnormal vibration occurs, stop the machine and inspect it. Make repairs before you operate.
- Use only accessories and attachments approved by the manufacturer of the machine. Keep safety labels visible when installing accessories and attachments.
- Do not wear radio or music headphones. Safe service and operation requires your full attention.
- When machine is left unattended, stored, or parked, lower the mower deck unless a positive mechanical lock is used.

## Using a Spark Arrestor

The engine in this machine is not equipped with a spark arrestor muffler. The California Public Resources Code, section 4442.5 provides as follows:

No person shall sell, offer for sale, lease, or rent to any person any internal combustion engine subject to Section 4442 or 4443, and not subject to Section 13005 of the Health and Safety Code, unless the person provides a written notice to the purchaser or bailee, at the time of sale or at the time of entering into the lease or rental contract, stating that it is a violation of Section 4442 or 4443 to use or operate the engine on any forest-covered, brush-covered, or grass-covered land unless the engine is equipped with a spark arrestor, as defined in Section 4442, maintained in effective working order or the engine is

# Safety

constructed, equipped, and maintained for the prevention of fire pursuant to Section 4443. Cal. Pub. Res. Code 4442.5.

Other states or jurisdictions may have similar laws. A spark arrestor for your machine may be available from your authorized dealer. An installed spark arrestor must be maintained in good working order by the operator.

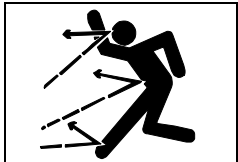

## Checking Mowing Area

- Clear mowing area of objects that might be thrown. Keep people and pets out of mowing area.

- Low-hanging branches and similar obstacles can injure the operator or interfere with mowing operation. Before mowing, identify potential obstacles such as low-hanging branches, and trim or remove those obstacles.

- Study mowing area. Set up a safe mowing pattern. Do not mow where traction or stability is doubtful.

- Test drive area with mower lowered but not running. Slow down when you travel over rough ground.

## Parking Safely

1. Stop machine on a level surface, not on a slope.
2. Disengage mower blades or any other attachments.
3. Lower attachments to the ground.
4. Lock the park brake.
5. Stop the engine.
6. Remove the key.
7. Wait for engine and all moving parts to stop before you leave the operator's seat.
8. Close fuel shut-off valve, if your machine is equipped.
9. Disconnect the negative battery cable or remove the spark plug wire(s) (for gasoline engines) before servicing the machine.

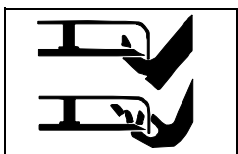

## Rotating Blades are Dangerous

**HELP PREVENT SERIOUS OR FATAL ACCIDENTS:**

- Rotating blades can cut off arms and legs, and throw objects. Failure to observe safety instructions could result in serious injury or death.

- Keep hands, feet and clothing away from mower deck when engine is running.
- Be alert at all times, drive forward and in reverse carefully. People, especially children can move quickly into the mowing area before you know it.
- Before backing up, stop mower blades or attachments and look down and behind the machine carefully, especially for children.
- Do not mow in reverse.
- Shut off blades when you are not mowing.
- Park machine safely before leaving the operator's station for any reason including emptying the grasscatchers or unplugging the chute.
- The mower blades should stop in approximately five seconds when the mower is disengaged. If you believe that your blades may not be stopping in that period of time, take your machine to your authorized dealer where they can safely check and service your machine.

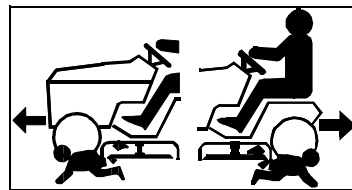

## Protect Children

- Death or serious injury can occur when young children associate having fun with a lawn mowing machine simply because

someone has given them a ride on a machine.

- Children are attracted to lawn mowing machines and mowing activities. They don't understand the dangers of rotating blades or the fact that the operator is unaware of their presence.
- Children who have been given rides in the past may suddenly appear in the mowing area for another ride and be run over or backed over by the machine.
- Tragic accidents with children can occur if the operator is not alert to the presence of children, especially when a child approaches a machine from behind. Before and while backing up, stop mower blades and look down and behind the machine carefully, especially for children.
- Never carry children on a machine or attachment, even with the blades off. Do not tow children in a cart or trailer. They can fall off and be seriously injured or interfere with safe machine operation.
- Never use the machine as a recreational vehicle or to entertain children.
- Never allow children or an untrained person operate the machine. Instruct all operators not to give children a ride on the machine or in an attachment.
- Keep children indoors, out of the mowing area, and in the

# Safety

watchful eye of a responsible adult, other than the operator, when a mower is being operated.

- Stay alert to the presence of children. Never assume that children will remain where you last saw them. Turn the machine off if a child enters the work area.
- Use extreme care when approaching blind corners, shrubs, trees, or other objects that may block your view of a child.

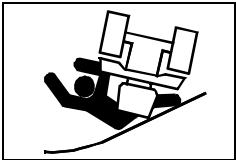

## Avoid Tipping

- Slopes are a major factor related to loss-of-control and tip-over accidents, which can result in severe injury or death. Operation on all slopes

requires extra caution. If you cannot back up the slope or if you feel uneasy on it, do not mow it.

- Mow up and down slopes, not across.
- Watch for holes, ruts, bumps, rocks, or other hidden objects. Uneven terrain could overturn the machine. Tall grass can hide obstacles.
- Choose a low ground speed so you will not have to stop or shift while on a slope.
- Do not mow or operate machine on wet grass. Tires may lose traction. Tires may lose traction on slopes even though the brakes are functioning properly.
- Always keep the machine in gear when going down slopes. Do not shift to neutral and coast downhill.
- Avoid starting, stopping or turning on a slope. If the tires lose traction, disengage the blades and proceed slowly, straight down the slope.
- Keep all movement on slopes slow and gradual. Do not make sudden changes in speed or direction, which could cause the machine to roll over.
- Use extra care while operating machine with grasscatchers or other attachments, they can affect stability of the machine. Do not use on steep slopes.
- Do not try to stabilize the machine by putting your foot on the ground.
- Do not mow near drop-offs, ditches, embankments, or bodies of water. The machine could suddenly roll over if a wheel goes over the edge or the edge caves in. Leave a safety area between the machine and any hazard.
- Follow the manufacturer's recommendations for wheel weights or counterweights for added stability when operating on slopes or using front or rear mounted attachments. Remove weights when not required.

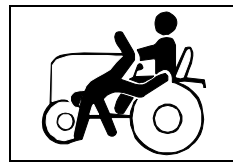

## Keep Riders Off

- Only allow the operator on the machine. Keep riders off.
- Riders on the machine or attachment may be struck by foreign objects or thrown off the machine causing serious injury.
- Riders obstruct the operator's view resulting in the machine being operated in an unsafe manner.

## Towing Loads Safely

- Stopping distance increases with speed and weight of towed load. Travel slowly and allow extra time and distance to stop.
- Total towed weight must not exceed combined weight of pulling machine, ballast and operator. Use counterweights or wheel weights as described in the attachment or pulling machine operator's manual.
- Excessive towed load can cause loss of traction and loss of control on slopes. Reduce towed weight when operating on slopes.
- Never allow children or others in or on towed equipment.
- Use only approved hitches. Tow only with a machine that has a hitch designed for towing. Do not attach towed equipment except at the approved hitch point.
- Follow the manufacturer's recommendations for weight limits for towed equipment and towing on slopes.
- If you cannot back up a slope with a towed load, the slope is too steep to operate on with the towed load. Reduce the towed load or do not operate.
- Do not turn sharply. Use additional caution when turning or operating under adverse surface conditions. Use care when reversing.
- Do not shift to neutral and coast downhill.

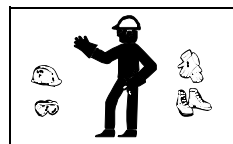

## Wear Appropriate Clothing

- Always wear eye protection when operating the machine.
- Wear close fitting clothing and safety equipment appropriate for the job.
- While operating this machine, always wear substantial footwear and long trousers. Do not operate the equipment when barefoot or wearing open sandals.
- Wear a suitable protective device such as earplugs. Loud noise can cause impairment or loss of hearing.

# Safety

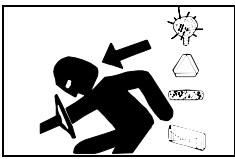

## Driving Safely on Public Roads

Avoid personal injury or death resulting from a collision with another vehicle on public roads:

- Use safety lights and devices. Slow moving machines when driven on public roads are hard to see, especially at night.
- Whenever driving on public roads, use flashing warning lights and turn signals according to local regulations. Extra flashing warning lights may need to be installed.



## Practice Safe Maintenance

• Only qualified, trained adults should service this machine. Understand service procedure before doing work.

- Never operate machine in a closed area where dangerous carbon monoxide fumes can collect.
- Keep all nuts and bolts tight, especially blade attachment bolts, to be sure the equipment is in safe working condition.
- Never tamper with safety devices. Check their proper operation regularly.
- Keep machine free of grass, leaves or other debris build-up. Clean up oil or fuel spillage and remove any fuel-soaked debris. Allow the machine to cool before storing.
- If you strike a foreign object, stop and inspect the machine. Repair, if necessary, before restarting.
- Never make any adjustments or repairs with the engine running. Wait for all movement to stop on machine before adjusting, cleaning or repairing.
- Check grasscatcher components and the discharge guard frequently and replace with manufacturer's recommended parts, when necessary. Grasscatcher components are subject to wear, damage, and deterioration which could expose moving parts or allow objects to be thrown.
- Mower blades are sharp. Wrap the blade or wear gloves, and use extra care when servicing them. Only replace blades. Never straighten or weld them.
- Check brake operation frequently. Adjust and service as required.
- Maintain or replace safety and instruction labels, as necessary.
- On multi-bladed machines, take care as rotating one blade can cause other blades to rotate.
- Keep hands, feet, clothing, jewelry, and long hair away from any moving parts, to prevent them from getting caught.

- Lower any attachments to the ground before cleaning or servicing machine. Disengage all power and stop the engine. Lock park brake and remove the key. Let machine cool.
- Securely support any machine elements that must be raised for service work. Use jack stands or lock service latches to support components when needed.
- Disconnect battery or remove spark plug wire (for gasoline engines) before making any repairs. Disconnect negative terminal first and positive last. Install positive terminal first and negative last.
- Before servicing machine or attachment, carefully release pressure from any components with stored energy, such as hydraulic components or springs.
- Keep all parts in good condition and properly installed. Fix damage immediately. Replace worn or broken parts.
- Charge batteries in an open, well-ventilated area, away from sparks. Unplug battery charger before connecting or disconnecting from the battery. Wear protective clothing and use insulated tools.
- Do not strike the flywheel with a hammer or hard object because the flywheel may later shatter during operation.
- If equipped with hydraulic lift - release hydraulic pressure by lowering attachment or cutting units to the ground or to a mechanical stop and move hydraulic control levers back and forth.



## Avoid High Pressure Fluids

- Hydraulic hoses and lines can fail due to physical damage, kinks, age, and exposure. Check hoses and lines regularly. Replace damaged hoses and lines.
- Hydraulic fluid connections can loosen due to physical damage and vibration. Check connections regularly. Tighten loose connections.
- Escaping fluid under pressure can penetrate the skin causing serious injury. Avoid the hazard by relieving pressure before disconnecting hydraulic or other lines. Tighten all connections before applying pressure.
- Search for leaks with a piece of cardboard. Protect hands and body from high pressure fluids.
- If an accident occurs, see a doctor immediately. Any fluid injected into the skin must be surgically removed within a few hours or gangrene may result. Doctors unfamiliar with this type of injury should reference a knowledgeable medical source. Such information is available from Deere & Company Medical Department in Moline, Illinois, U.S.A. Information may be obtained in the United States and

# Safety

Canada only by calling 1-800-822-8262.



## Prevent Fires

- Besides routine maintenance, one of the best ways to keep your John Deere equipment running efficiently and to reduce fire risk is to regularly remove debris buildup from the machine.

- Please review these

recommendations with all operators. See your John Deere dealer with questions.

- Always follow all safety procedures posted on the machine and in this operator manual. Before carrying out any inspection or cleaning, always shut off engine, set parking brake and remove ignition key.
- After operating, allow machine to cool in an open area before cleaning or storing. Do not park machine near flammable materials such as wood, cloth or chemicals.
- Empty any grasscatcher bags or containers completely before storing.
- Frequency of these inspections and cleaning will vary depending on a number of factors including operating conditions, machine configuration, operating speeds and weather conditions particularly dry, hot and windy conditions. When you are operating in these conditions, inspect and clean these areas frequently throughout the day.
- Wind direction, terrain type and moisture content of surrounding vegetation can effect where and how much debris accumulates.
- Debris can accumulate anywhere on the machine, especially on horizontal surfaces.
- Keeping engine area clean will provide the greatest impact on fire prevention. Other areas requiring regular inspection and cleaning include behind wheel rims, wire harness, hose/line routings, mowing attachments, etc. Compressed air, leaf blowers or high pressured water can assist keeping these areas clean.
- Excess lubrication or fuel/oil leaks or spills on the machine can also serve as collection sites for debris. Prompt machine repair and oil/fuel cleanup will minimize the potential for debris collection and reduced cooling throughout machine life.
- Bearing failures or overheating can result in a fire. To reduce this risk, always follow the instructions in the machine operator's manual regarding lubrication intervals and locations. Washing the machine while warm may also reduce bearing life and increase potential for premature bearing failure.

- Always shut off fuel when storing or transporting machine, if the machine has a fuel shutoff.



## Handling Fuel Safely

**To avoid personal injury or property damage, use extreme care in handling fuel. Fuel is extremely flammable and fuel vapors are explosive:**

- Extinguish all cigarettes, cigars, pipes, and other sources of ignition.
- Use only an approved fuel container. Use only non-metal, portable fuel containers approved by the Underwriter's Laboratory (U.L.) or the American Society for Testing & Materials (ASTM). If using a funnel, make sure it is plastic and has no screen or filter.
- Never remove the fuel tank cap or add fuel with the engine running. Allow engine to cool before refueling.
- Never add fuel to or drain fuel from the machine indoors. Move machine outdoors and provide adequate ventilation.
- Clean up spilled fuel immediately. If fuel is spilled on clothing, change clothing immediately. If fuel is spilled near machine, do not attempt to start the engine but move the machine away from the area of spillage. Avoid creating any source of ignition until fuel vapors have dissipated.
- Never store the machine or fuel container where there is an open flame, spark, or pilot light such as on a water heater or other appliance.
- Prevent fire and explosion caused by static electric discharge. Static electric discharge can ignite fuel vapors in an ungrounded fuel container.
- Never fill containers inside a vehicle or on a truck or trailer bed with a plastic liner. Always place containers on the ground away from your vehicle before fueling.
- Remove fuel-powered equipment from the truck or trailer and refuel it on the ground. If this is not possible, then refuel such equipment with a portable container, rather than from a fuel dispenser nozzle.
- Keep the nozzle in contact with the rim of the fuel tank or container opening at all times until the fueling is complete. Do not use a nozzle lock-open device.
- Never overfill fuel tank. Replace fuel tank cap and tighten securely.
- Replace all fuel container caps securely after use.
- For gasoline engines, do not use gas with methanol. Methanol is harmful to your health and to the environment.



**Suggest:**

**If the above button click is invalid.**

**Please download this document**

**first, and then click the above link**

**to download the complete manual.**

**Thank you so much for reading**

# Safety

---



## Tire Safety

Explosive separation of a tire and rim parts can cause serious injury or death:

- Do not attempt to mount a tire without the proper equipment and experience to perform the job.
- Always maintain the correct tire pressure. Do not inflate the tires above the recommended pressure. Never weld or heat a wheel and tire assembly. The heat can cause an increase in air pressure resulting in a tire explosion. Welding can structurally weaken or deform the wheel.
- When inflating tires, use a clip-on chuck and extension hose long enough to allow you to stand to one side and NOT in front of or over the tire assembly.
- Check tires for low pressure, cuts, bubbles, damaged rims or missing lug bolts and nuts.

## Checking Wheel Hardware

- A serious accident could occur causing serious injury if wheel hardware is not tight.
- Check wheel hardware tightness often during the first 100 hours of operation.
- Wheel hardware must be tightened to specified torque using the proper procedure anytime it is loosened.

## Handling Waste Product and Chemicals

Waste products, such as, used oil, fuel, coolant, brake fluid, and batteries, can harm the environment and people:

- Do not use beverage containers for waste fluids - someone may drink from them.
- See your local Recycling Center or authorized dealer to learn how to recycle or get rid of waste products.
- A Material Safety Data Sheet (MSDS) provides specific details on chemical products: physical and health hazards, safety procedures, and emergency response techniques. The seller of the chemical products used with your machine is responsible for providing the MSDS for that product.

**<https://www.ebooklibonline.com>**

Hello dear friend!

Thank you very much for reading.

Enter the link into your browser.

The full manual is available for immediate download.

**<https://www.ebooklibonline.com>**