

**JOHN DEERE**  
**AG & TURF DIVISION**

---

**Walk-Behind Mower**  
**MowMentum™ JS28, JS38, JS48**

OMGX24373 A2

**OPERATOR'S MANUAL**



**JOHN DEERE**

North American Version  
Litho in U.S.A.

# Introduction

**⚠ WARNING:** The Engine Exhaust from this product contains chemicals known to the State of California to cause cancer, birth defects or other reproductive harm.

California Proposition 65 Warning

## Table of Contents

Introduction.....	1
Product Identification.....	1
Safety Labels.....	3
Safety Labels.....	4
Safety.....	6
Assembly.....	8
Operating Controls.....	10
Operating.....	12
Service Intervals.....	17
Service.....	17
Troubleshooting.....	30
Storage.....	30
Specifications.....	31
Warranty.....	33
Index.....	35
Getting Quality Service.....	35

## Introduction

### Thank You for Purchasing a John Deere Product

We appreciate having you as a customer and wish you many years of safe and satisfied use of your machine.

### Using Your Operator Manual

This manual is an important part of your machine and should remain with the machine when you sell it.

Reading your operator's manual will help you and others avoid personal injury or damage to the machine. Information given in this manual will provide the operator with the safest and most effective use of the machine. Knowing how to operate this machine safely and correctly will allow you to train others who may operate this machine.

This manual and safety signs on your machine may also be available in other languages (see your authorized dealer to order).

Sections in your operator's manual are placed in a specific order to help you understand all the safety messages and learn the controls so you can operate this machine safely. You can also use this manual to answer any specific operating or servicing questions.

The machine shown in this manual may differ slightly from your machine, but will be similar enough to help you understand our instructions.

RIGHT-HAND and LEFT-HAND sides are determined by facing in the direction the machine will travel when going forward. When you see a broken line (-----), the item referred to is hidden from view.

### Special Messages

Your manual contains special messages to bring attention to potential safety concerns, machine damage as well as helpful operating and servicing information. Please read all the information carefully to avoid injury and machine damage.



**CAUTION:** Avoid injury! This symbol and text highlight potential hazards or death to the operator or bystanders that may occur if the hazards or procedures are ignored.

**IMPORTANT:** Avoid damage! This text is used to tell the operator of actions or conditions that might result in damage to the machine.

**NOTE:** General information is given throughout the manual that may help the operator in the operation or service of the machine.

## Product Identification

### Record Identification Numbers

JS28 PIN (010001-)

JS38 PIN (010001-)

JS48 PIN (010001-)

If you need to contact an Authorized Service Center for information on servicing, always provide the product model and identification numbers.

You will need to locate the model and serial number for the machine and for the engine of your machine and record the information in the spaces provided below.

DATE OF PURCHASE:

DEALER NAME:

**Original Instruction**  
All information, illustrations and specifications in this manual are based on the latest information at the time of publication. The right is reserved to make changes at any time without notice.

COPYRIGHT© 2012  
Deere & Co.  
John Deere Ag & Turf Division  
All rights reserved  
Previous Editions  
COPYRIGHT© none

# Product Identification

---

DEALER PHONE:

\_\_\_\_\_

PRODUCT IDENTIFICATION NUMBER:

\_\_\_\_\_

ENGINE SERIAL NUMBER:

\_\_\_\_\_

## **Register Your Product and Warranty Online**

To register your product through the Internet, simply go to [www.JohnDeereWarrantyRegistration.com](http://www.JohnDeereWarrantyRegistration.com). Completing the information, either online or with the product warranty card, will ensure the customer that their product receives all post sales service and important product information.

**<https://www.ebooklibonline.com>**

Hello dear friend!

Thank you very much for reading.

Enter the link into your browser.

The full manual is available for immediate download.

**<https://www.ebooklibonline.com>**

# Safety Labels

## Safety Label Location

### Safety Labels

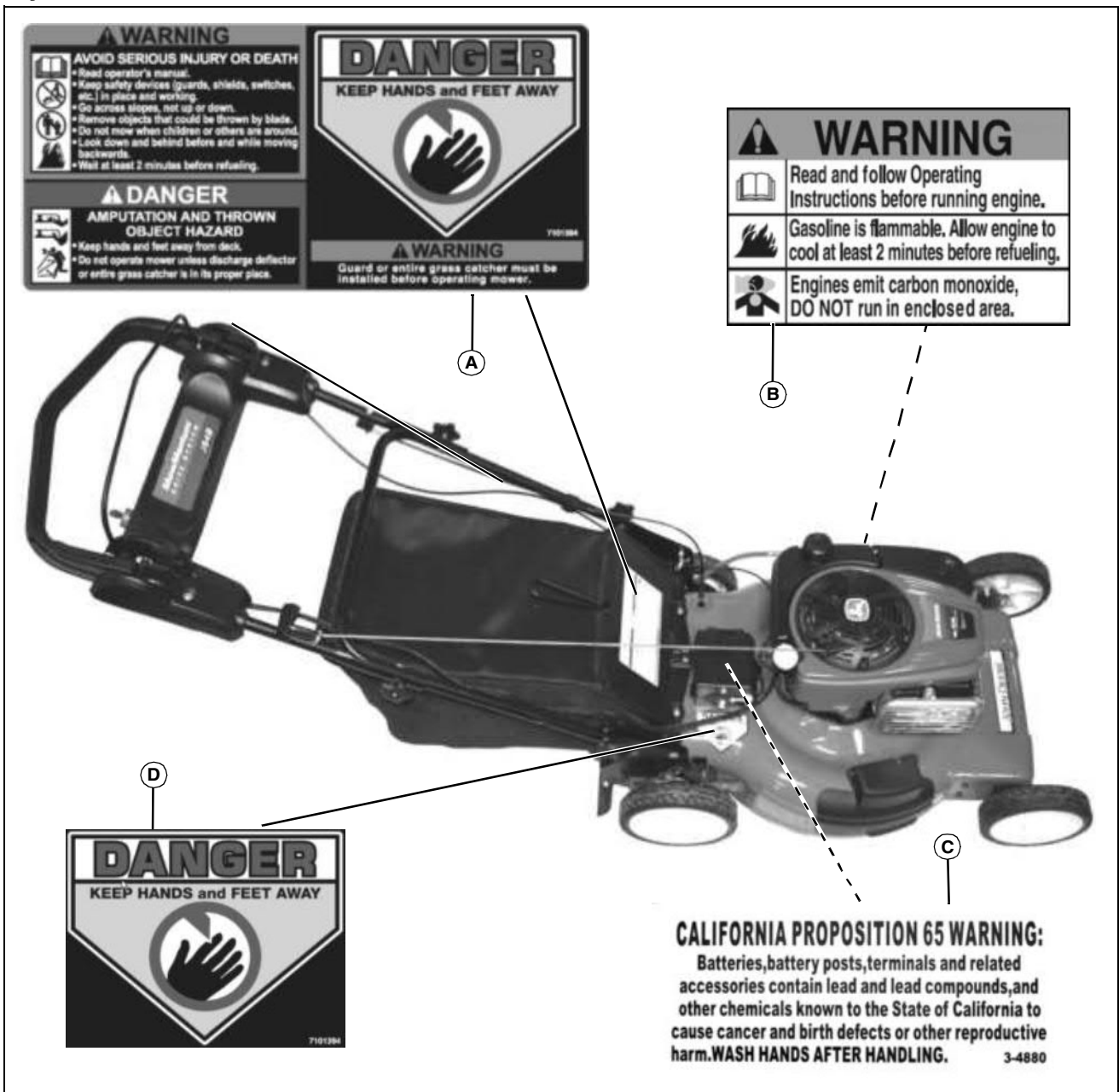

MX49900

Picture Note: Use label number listed in table below to locate complete text of safety label message following this illustration.

- A- WARNING - GX22881
- B- WARNING - 3255Y
- C- WARNING - 34880
- D- DANGER - GC00671

# Safety Labels

## Safety Labels



### Understanding The Machine Safety Labels

The machine safety labels shown in this section are placed in important areas on your machine to draw attention to potential safety hazards.

On your machine safety labels, the words DANGER, WARNING, and CAUTION are used with this safety-alert symbol. DANGER identifies the most serious hazards.

The operator's manual also explains any potential safety hazards whenever necessary in special safety messages that are identified with the word, CAUTION, and the safety-alert symbol.

### DANGER GC00671



GC00671

- KEEP HANDS and FEET AWAY

### WARNING GX22881

#### AVOID SERIOUS INJURY OR DEATH



GX22881B

- Read operator's manual.
- Keep safety devices (guards, shields, switches, etc.) in place and working.
- Go across slopes, not up or down.
- Remove objects that could be thrown by blade.
- Do not mow when children or others are around.
- Look down and behind before and while moving backwards.
- Wait at least 2 minutes before refueling.

# Safety Labels

## DANGER GX22881

### AMPUTATION AND THROWN OBJECT HAZARD



GX22881C

- Keep hands and feet away from deck.
- Do not operate mower unless discharge deflector or entire grass catcher is in its proper place.

## DANGER GX22881



GX22881D

- KEEP HANDS and FEET AWAY

## WARNING GX22881

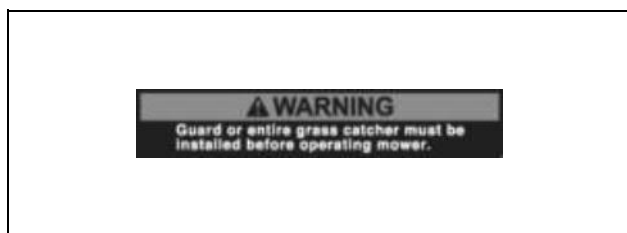

GX22881E

- Guard or entire grass catcher must be installed before operating mower.

## WARNING 34880

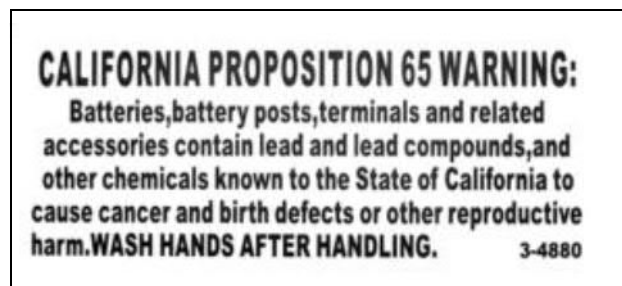

MX28303

CALIFORNIA PROPOSITION 65 WARNING: Batteries, battery posts, terminals and related accessories contain lead and lead compounds, and other chemicals known to the State of California to cause cancer and birth defects or other reproductive harm. WASH HANDS AFTER HANDLING.

## WARNING 3255Y

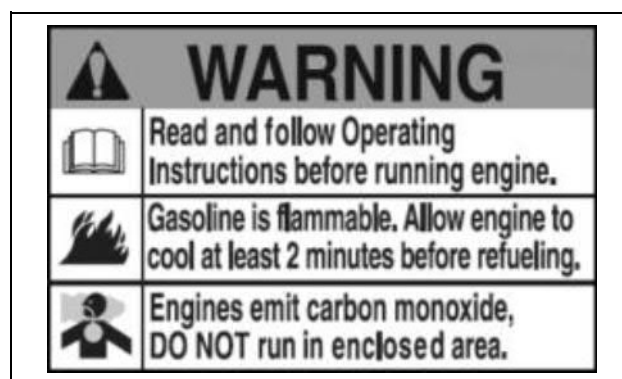

GX3255Y

- Read and follow Operating Instructions before running engine.
- Gasoline is flammable. Allow engine to cool at least 2 minutes before refueling.
- Engines emit carbon monoxide, DO NOT run in enclosed area.

## Emission Control System Certification Label

**NOTE: Tampering with emission controls and components by unauthorized personnel may result in severe fines or penalties. Emission controls and components can only be adjusted by EPA and/or CARB authorized service centers. Contact your John Deere Retailer concerning emission controls and component questions.**

The presence of an emissions label signifies that the engine has been certified with the United States Environmental Protection Agency (EPA) and/or California Air Resources Board (CARB).

The emissions warranty applies only to those engines marketed by John Deere that have been certified by the EPA and/or CARB; and used in the United States and Canada in off-road mobile equipment.

## Emission Compliance Period

If your engine has the emission compliance category listed on the emission control system certification or air index label, this indicates the number of operating hours for which the engine has been certified to meet EPA and/or CARB emission requirements. The following table provides the engine compliance period in hours associated with the category found on the certification label.

# Safety

Agency	Category	Hours
EPA	C	125
EPA	B	250
EPA	A	500
CARB	Moderate	125
CARB	Intermediate	250
CARB	Extended	500

## Certification

Your mower has been certified for compliance with American National Standards Institute B-71.1-2003, "Safety Specifications" for Power Lawn Mowers, Lawn and Garden Tractors, and Lawn Tractors.

## Safety

### Operating Safely

- This cutting machine is capable of amputating hands and feet and throwing objects. Failure to observe the following safety instructions could result in serious injury or death.
- Read, understand and follow all instructions on the machine and in the manual before starting. Be thoroughly familiar with the controls and the proper use of the machine before starting.
- Do not put hands or feet near or under the machine. Keep clear of the discharge opening at all times.
- Only allow responsible adults, who are familiar with the instructions, to operate this machine. Local regulations may restrict the age of the operator.
- Clear the area of objects such as rocks, toys, wire, and similar items which could be thrown by the blade. Stay behind the handle when the engine is running.
- Be sure the area is clear of bystanders before operating. Stop machine if anyone enters the area.
- Do not operate the mower barefooted or while wearing sandals. Always wear substantial footwear.
- Do not pull machine backward unless absolutely necessary. Always look down and behind before and while moving backward.
- Never direct discharged material toward anyone. Avoid discharging material against a wall or obstruction. Material may ricochet back toward the operator. Stop the blade when crossing gravel surfaces.
- Do not operate machine without the entire grasscatcher, discharge guard, rear guard, or other safety protective devices in place and working. Never operate with the discharge deflector raised, removed, or altered, unless using a grasscatcher.
- Never leave a running machine unattended.
- Stop the engine and wait until the blade comes to complete stop before cleaning the machine, removing grasscatcher, or unclogging the discharge guard.
- Operate machine only in daylight or good artificial light.
- Do not operate the mower while under the influence of alcohol or drugs.
- Never operate mower in wet grass. Always be sure of your footing. Walk; never run.
- Disengage the drive system, if so equipped, before starting the engine.
- If the machine should start to vibrate abnormally, stop the engine and check for the cause immediately. Vibration is generally a warning of trouble.
- Always wear safety goggles or safety glasses with side shields when operating mower.
- See manufacturer's instructions for proper operation and installation of accessories. Only use accessories approved by the manufacturer.
- Inspect machine before you operate. Be sure hardware is tight. Repair or replace damaged, badly worn, or missing parts. Make any necessary adjustments before you operate.
- Before using, always visually inspect to see that the blades, blade bolts and the mower assembly are not worn and damaged. Replace worn and damaged blades as needed.
- Make sure spark plug, muffler, fuel cap and air cleaner are in place before starting the engine.

# Safety

- Keep safety labels visible when installing accessories and attachments.

## Parking Safely

1. Stop mower on a level surface, not on a slope.
2. Disengage mower blades and wheel drive.
3. Stop the engine.
4. If mower is electric start, remove key from ignition.
5. Wait for engine and all moving parts to stop.
6. Remove the spark plug wire before servicing the mower.

## Using a Spark Arrestor

The California Public Resources Code, section 4442.5 provides as follows:

No person shall sell, offer for sale, lease, or rent to any person any internal combustion engine subject to Section 4442 or 4443, and not subject to Section 13005 of the Health and Safety Code, unless the person provides a written notice to the purchaser or bailee, at the time of sale or at the time of entering into the lease or rental contract, stating that it is a violation of Section 4442 or 4443 to use or operate the engine on any forest-covered, brush-covered, or grass-covered land unless the engine is equipped with a spark arrestor, as defined in Section 4442, maintained in effective working order or the engine is constructed, equipped, and maintained for the prevention of fire pursuant to Section 4443. Cal. Pub. Res. Code 4442.5.

Other states or jurisdictions may have similar laws. A spark arrestor for your machine may be available from your authorized dealer. An installed spark arrestor must be maintained in good working order by the operator.

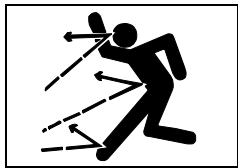

## Checking Mowing Area

- Clear mowing area of objects that might be thrown. Keep people and pets out of mowing area.
- Low-hanging branches and similar obstacles can injure the operator or interfere with

mowing operation. Before mowing, identify potential obstacles such as low-hanging branches, and trim or remove those obstacles.

- Study mowing area. Set up a safe mowing pattern. Do not mow where traction or stability is doubtful.



## Rotating Blades are Dangerous - Protect Children and Prevent Accidents

### Protect Children:

- Tragic accidents can occur if the operator is not alert to the presence of children. Children are often attracted to lawn-mowing machines and mowing activity. Stay alert to the presence of children. Never assume that children will remain where you last saw them.
- Keep children indoors, out of the mowing area, and in the watchful eye of a responsible adult, other than the operator, when a mower is being operated.
- Be alert and turn mower off if a child enters the work area. They don't understand the dangers of rotating blades or the fact that the operator is unaware of their presence.
- Never allow a child or an untrained person to operate the machine.
- Use extra care when approaching blind corners, shrubs, trees, or other objects that may block your view of a child.

## Operating Safely on Slopes

- Slopes are a major factor related to slip and fall accidents which can result in severe injury. Operation on all slopes requires extra caution. If you feel uneasy on a slope, do not mow it.
- Mow across the face of slopes, never up and down. Use extreme caution when changing direction on slopes.
- Watch for holes, ruts, bumps, rocks or other hidden objects. Uneven terrain could cause a slip and fall accident. Tall grass can hide obstacles.
- Do not mow on wet grass or excessively steep slopes. Poor footing could cause a slip and fall accident.
- Do not mow near drop offs, ditches, or embankments. The operator could lose footing or balance.
- Use extra care with grasscatchers. These can change the stability of the machine. Do not use grasscatcher on steep slopes.

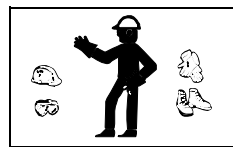

## Wear Appropriate Clothing

- Always wear eye protection when operating the machine.
- Wear close fitting clothing and safety equipment appropriate for the job.

- While operating this machine, always wear substantial footwear and long trousers. Do not operate the equipment when barefoot or wearing open sandals.
- Wear a suitable protective device such as earplugs. Loud noise can cause impairment or loss of hearing.



## Practice Safe Maintenance

- Only qualified, trained adults should service this machine. Understand service procedure before doing work.

- Never operate machine in a closed area where dangerous carbon monoxide fumes can collect.
- Keep all nuts and bolts tight, especially blade attachment bolts, to be sure the equipment is in safe working condition.
- Never tamper with safety devices. Check their proper operation regularly.
- Keep machine free of grass, leaves or other debris build-up. Clean up oil or fuel spillage and remove any fuel-soaked debris. Allow the machine to cool before storing.
- If you strike a foreign object, stop and inspect the machine. Repair, if necessary, before restarting.
- Never make adjustments or repairs with the engine running. Wait for all movement to stop before adjusting, cleaning or repairing. Disconnect the spark plug wire, and ground against the engine to prevent accidental starting.
- Check grasscatcher components and the discharge guard frequently and replace with manufacturer's recommended parts, when necessary. Grasscatcher components are subject to wear, damage, and deterioration which could expose moving parts or allow objects to be thrown.
- Mower blades are sharp. Wrap the blade or wear gloves, and use extra care when servicing them. Only replace blades. Never straighten or weld them.
- Do not change the governor setting or overspeed the engine.
- Maintain or replace safety and instruction labels, as necessary.
- Keep hands, feet, clothing, jewelry, and long hair away from any moving parts, to prevent them from getting caught.

# Assembly

- Never attempt to make wheel height adjustments while the engine is running.
- Keep all parts in good condition and properly installed. Fix damage immediately. Replace worn or broken parts.
- Do not strike the flywheel with a hammer or hard object because the flywheel may later shatter during operation.

## Prevent Fires

- Machine fires and structure fires can occur if a machine is stored before allowing it to cool, if debris is not removed from critical areas of the machine, or if machine is stored near combustible materials.
- Remove grass and debris completely from engine compartment and muffler area, and from on top of the mower deck, before and after operating machine, especially after mowing or mulching in dry conditions.
- Empty any grasscatcher bags or containers completely before storing.
- Always shut off fuel when storing or transporting machine, if the machine has a fuel shutoff.
- Do not store machine near an open flame or source of ignition, such as a water heater or furnace.
- Check fuel lines, tank, cap, and fittings frequently for cracks or leaks. Replace if necessary.

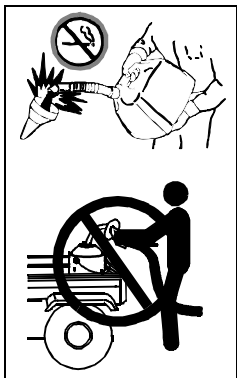

## Handling Fuel Safely

**To avoid personal injury or property damage, use extreme care in handling fuel. Fuel is extremely flammable and fuel vapors are explosive:**

- Extinguish all cigarettes, cigars, pipes, and other sources of ignition.
- Use only an approved fuel container. Use only non-metal, portable fuel containers approved by the Underwriter's Laboratory (U.L.) or the American Society for Testing & Materials (ASTM). If using a funnel, make sure it is plastic and has no screen or filter.
- Never remove the fuel tank cap or add fuel with the engine running. Allow engine to cool before refueling.
- Never add fuel to or drain fuel from the machine indoors. Move machine outdoors and provide adequate ventilation.
- Clean up spilled fuel immediately. If fuel is spilled on clothing, change clothing immediately. If fuel is spilled near machine, do not attempt to start the engine but move the machine away from the area of spillage. Avoid creating any source of ignition until fuel vapors have dissipated.
- Never store the machine or fuel container where there is an open flame, spark, or pilot light such as on a water heater or other appliance.
- Prevent fire and explosion caused by static electric discharge. Static electric discharge can ignite fuel vapors in an ungrounded fuel container.
- Never fill containers inside a vehicle or on a truck or trailer bed with a plastic liner. Always place containers on the ground away from your vehicle before fueling.
- Remove fuel-powered equipment from the truck or trailer and refuel it on the ground. If this is not possible, then refuel such equipment with a portable container, rather than from a fuel dispenser nozzle.
- Keep the nozzle in contact with the rim of the fuel tank or container opening at all times until the fueling is complete. Do not use a nozzle lock-open device.
- Never overfill fuel tank. Replace fuel tank cap and tighten securely.

- Replace all fuel container caps securely after use.
- For gasoline engines, do not use gas with methanol. Methanol is harmful to your health and to the environment.

## Handling Waste Product and Chemicals

Waste products, such as, used oil, fuel, coolant, brake fluid, and batteries, can harm the environment and people:

- Do not use beverage containers for waste fluids - someone may drink from them.
- See your local Recycling Center or authorized dealer to learn how to recycle or get rid of waste products.
- A Material Safety Data Sheet (MSDS) provides specific details on chemical products: physical and health hazards, safety procedures, and emergency response techniques. The seller of the chemical products used with your machine is responsible for providing the MSDS for that product.

## Assembly

### Prepare Handle Assembly

1. Remove mower from shipping carton. Mower shown as removed from shipping carton.

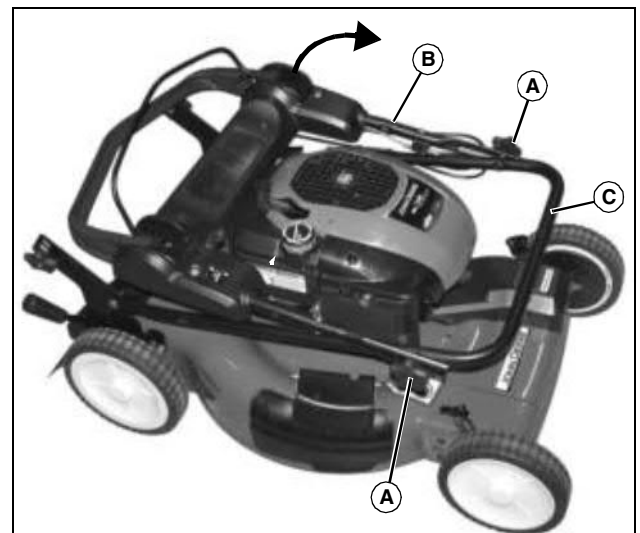

MX44278

2. Loosen upper handle knobs (A) on both sides and unfold upper handle (B) toward front of machine until upper handle aligns with and fits into lower handle (C). Securely tighten upper handle knobs (A) on both sides.

# Assembly

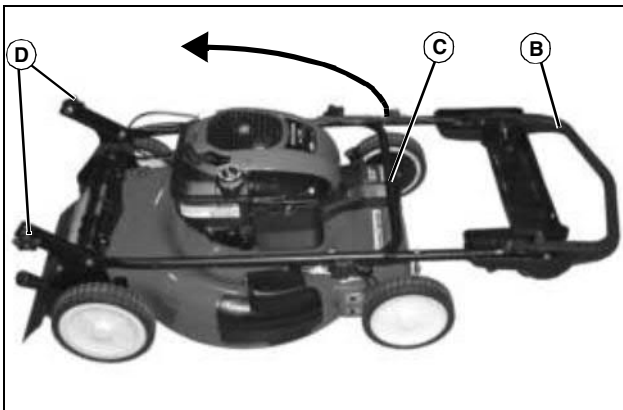

MX44279

3. Lift handle assembly (B)(C) up and toward back of machine.

**NOTE: Carriage bolts, lockwashers and knobs (D) may already be installed in brackets. Simply remove and install.**

4. Align holes in lower handle with one of three height adjustment holes in mounting brackets. Insert one carriage bolt into desired hole in each bracket, out through lower handle, and secure with lockwasher and knob (D), tightening securely.

**IMPORTANT: Avoid damage! Take care not to pinch cables between handles.**

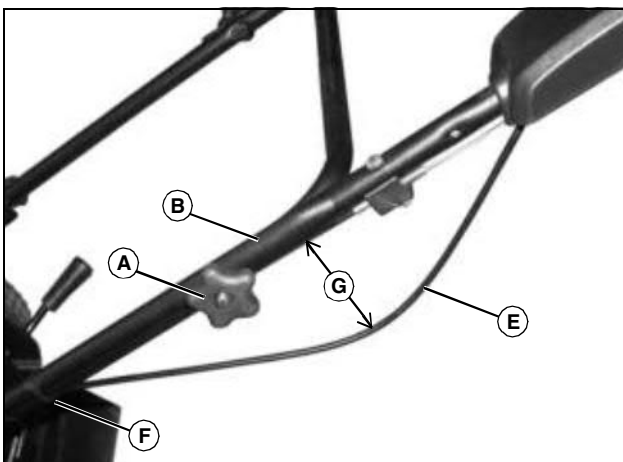

MX44280

5. When unfolding handle, be certain that the loop in the operator presence cable (E) is not removed by pulling on cable. Be certain tie strap (F) is installed at position 8 cm (3 in.) from center of upper handle knob (A). Be certain that there is a minimum distance of 10 cm (4 in.) (G) of center of loop between cable (E) and upper handle (B).



**CAUTION: Avoid injury! Pull starter handle slowly to avoid starting engine.**



MX49866

6. While squeezing the operator presence control (H) against the drive handle (I), slowly pull starter handle (J) up to rope guide (K) located on right side of upper handle as shown, and hook rope through guide.

## Install Discharge Assembly

Your mower comes with a side discharge cover installed on the mower deck, and is ready to be operated as a mulching mower. See the Operating section for information to install the discharge deflector or the grass bag.

## Check and Add Engine Oil

1. Remove dipstick and check engine oil level.
2. Add the supplied oil as needed up to the FULL mark on the dipstick. Do not overfill.

## Insert Fuel Stabilizer Cartridge in Fresh Start™ Fuel Cap (If Equipped)

Insert the fuel stabilizer cartridge if your machine is equipped with a Fresh Start fuel cap.

## Fill Fuel Tank

Fill the fuel tank.

## Check Machine Safety System

Perform safety system check to make sure the operator presence control is functioning properly.

# Operating Controls

## Operator Station Controls (JS28, JS38)

### Operating Controls

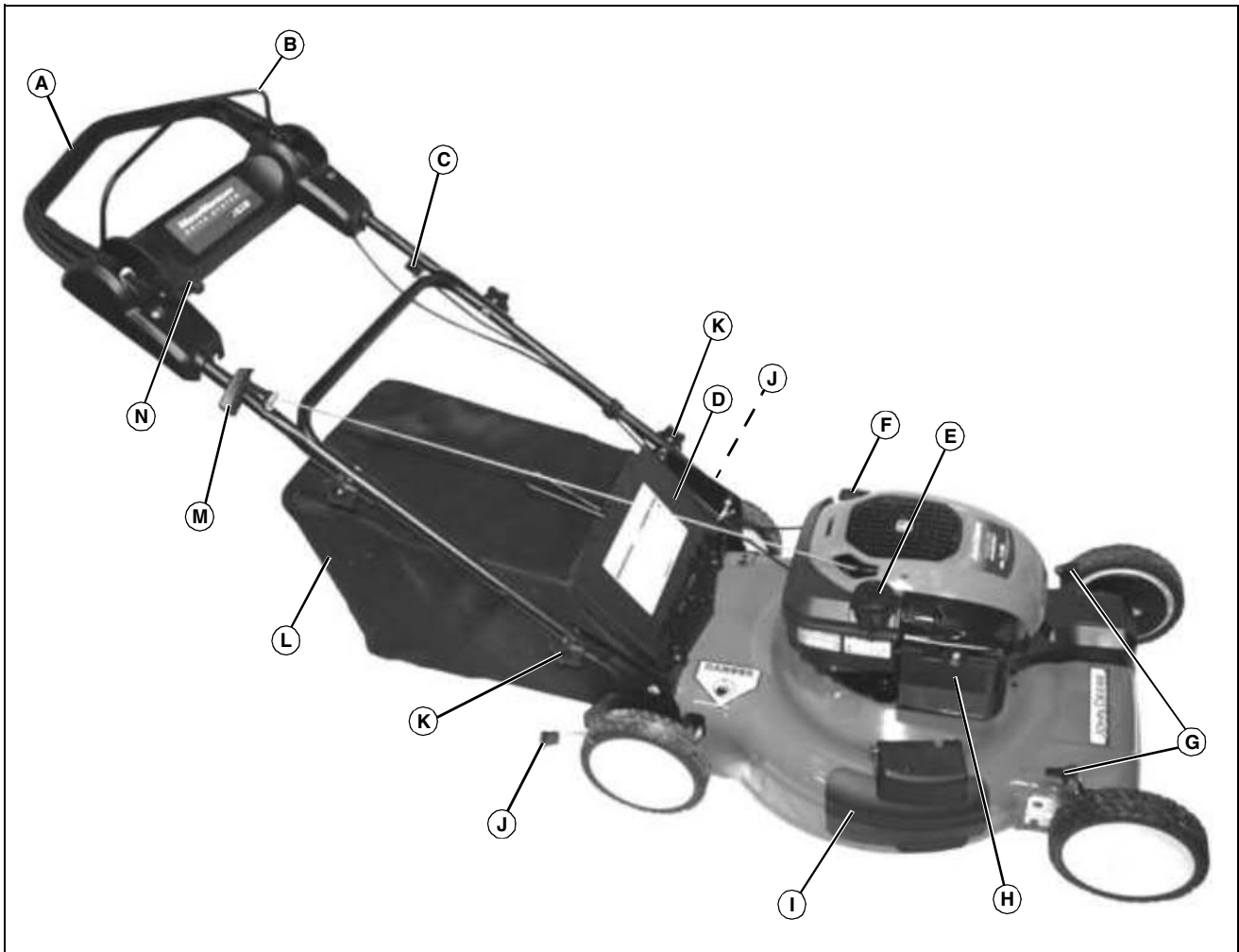

MX49899

Picture Note: JS28 model shown.

#### Key Description

A MowMentum™ Drive Handle

B Operator Presence Control

C Drive Cable Adjuster

D Rear Door, Spring-Loaded

E Fuel Fill Cap

F Oil Fill and Dipstick

G Front Cutting Height Adjustment Levers (JS28)

#### Key Description

H Air Cleaner Cover

I Side Discharge Cover

J Rear Wheel Cutting Height Adjustment Lever (JS28)  
All Wheel Cutting Height Adjustment Lever (JS38)

K Handle Height Adjustment

L Grass Bag

M Starter Handle

N Neutral Lock

# Operating Controls

## Operator Station Controls (JS48)

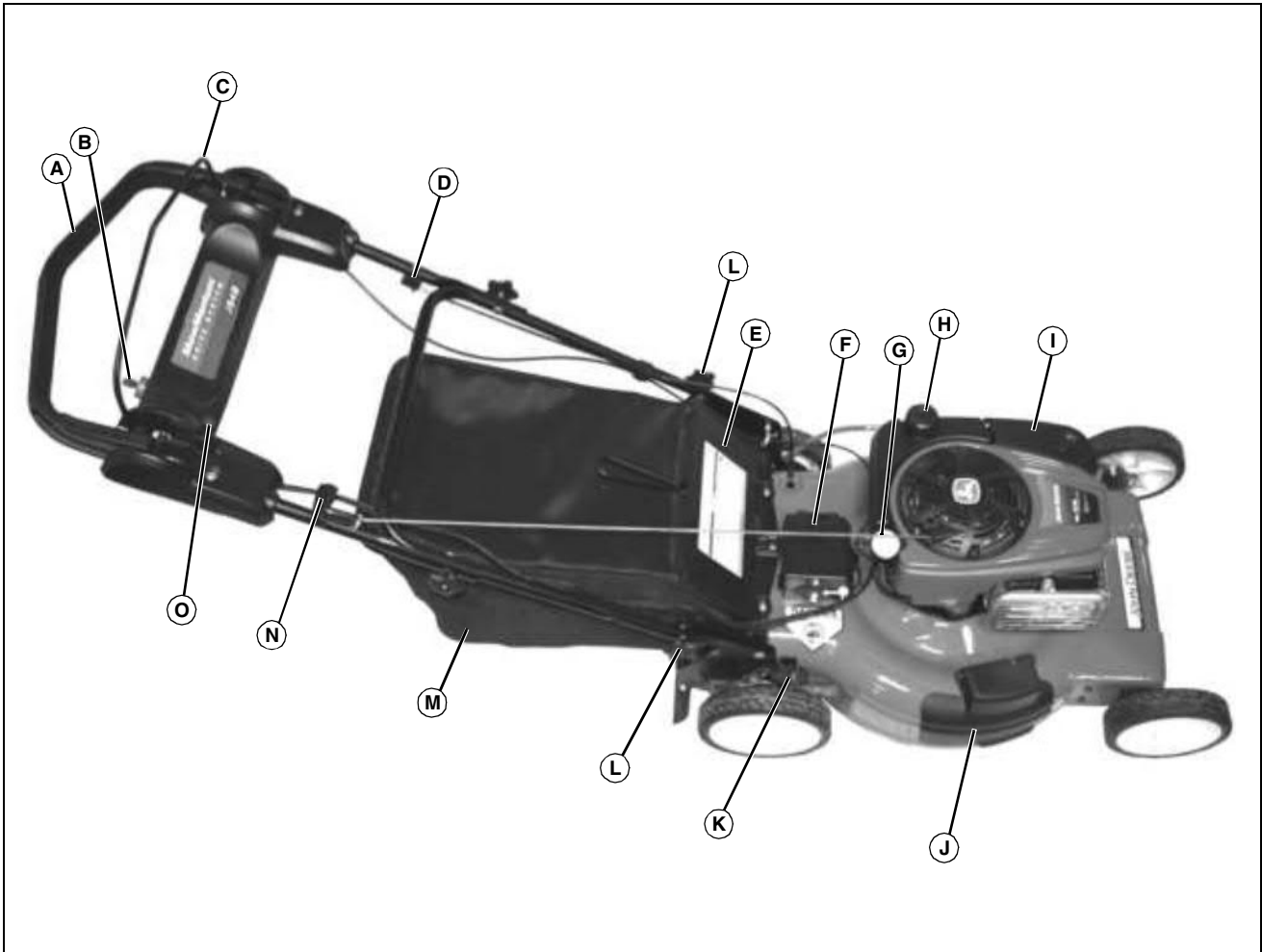

MX49900

Key	Description	Key	Description
A	MowMentum™ Drive Handle	I	Air Cleaner Cover
B	Electric Start Key Switch	J	Side Discharge Cover
C	Operator Presence Control	K	All Wheel Cutting Height Adjustment Lever
D	Drive Cable Adjuster	L	Handle Height Adjustment
E	Rear Door, Spring-Loaded	M	Grass Bag
F	Battery Box	N	Starter Handle
G	Oil Fill and Dipstick	O	Neutral Lock
H	Fuel Fill Cap		

# Operating

## Operating

### Daily Operating Checklist

- Test safety systems.
- Make sure all guards, deflectors and covers are in place and tightened.
- Check engine oil level.
- Check fuel level.
- Check fuel stabilizer cartridge in fuel cap.
- Check that handle knobs are tight.
- Check for proper cutting height.
- Remove grass and debris from machine.
- Check area below machine for leaks.

### Adjusting Cutting Height



**CAUTION: Avoid injury! Rotating blades are dangerous and can cut fingers and toes. Stop engine and wait for blade to stop rotating before adjusting cutting height.**

JS28 model is front wheel drive, with separate wheel adjustment levers on each wheel.

JS38 and JS48 models are rear wheel drive with a single height adjustment lever at the right rear wheel.

Key	Cutting Height Adjustments
(A)	30 mm (1.2 in.)
(B)	38 mm (1.5 in.)
(C)	48 mm (1.9 in.)
(D)	56 mm (2.2 in.)
(E)	66 mm (2.6 in.)
(F)	76 mm (3.0 in.)
(G)	86 mm (3.4 in.)
(H)	97 mm (3.8 in.)
(I)	107 mm (4.2 in.)

#### JS28

Each wheel has a height adjustment lever that raises and lowers the wheel individually.

1. Park machine safely. (See Parking Safely in the Safety Section.)

**NOTE: All four wheel heights are adjusted individually. The front height of cut levers can be set over the bent tabs and between them to obtain all nine positions. All wheels should be set in the same position to ensure even grass cutting.**

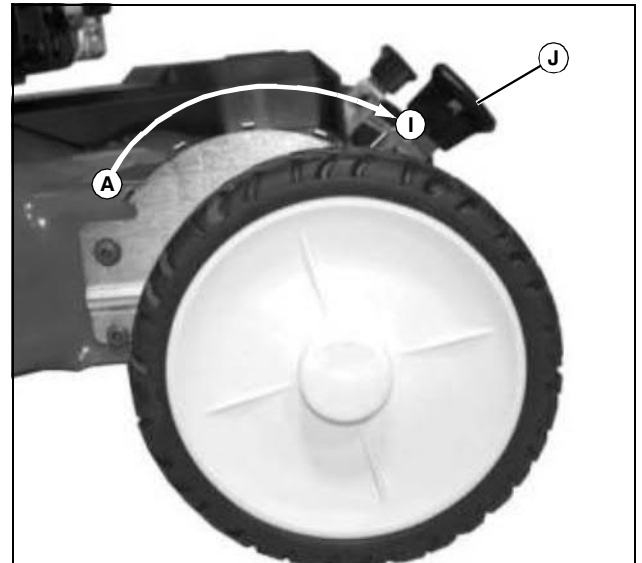

MX49867

**Picture Note: Right side shown.**

2. Pull the height adjusting lever (J) on each wheel outward and move to the desired cutting height. The lowest cutting height is location (A). The highest cutting height is location (I).

#### JS38, JS48

A single height adjustment lever at the right rear wheel is connected to linkage which raises or lowers the mower deck equally at all four wheels simultaneously.

1. Park machine safely. (See Parking Safely in the Safety Section.)



**Suggest:**

**If the above button click is invalid.**

**Please download this document**

**first, and then click the above link**

**to download the complete manual.**

**Thank you so much for reading**

# Operating



MX49870

Picture Note: Right side shown.

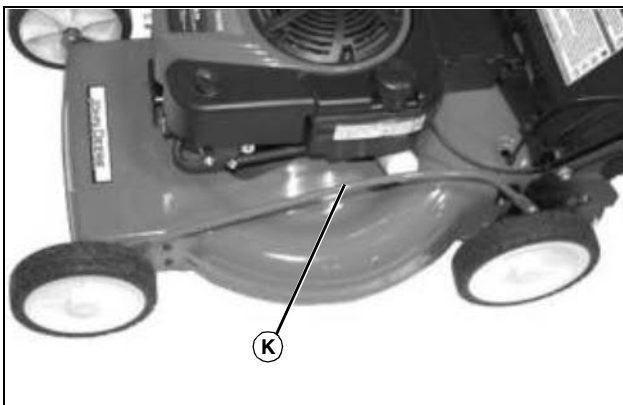

MX49871

Picture Note: Left side shown.

2. Pull the height adjusting lever (J) outward and move to the desired cutting height. The lowest cutting height is location (A). The highest cutting height is location (I).

3. Linkage (K) raises and lowers the four wheels simultaneously.

## Adjusting Handle Height

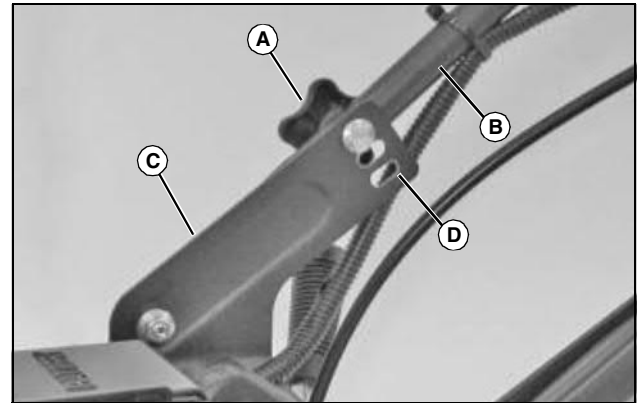

MX27683

1. Remove plastic knob (A), lock washer and carriage bolt securing lower handle (B) to mower deck bracket (C) at each side of mower deck. For first time set-up remove knob, washer and carriage bolt from pre-assembly position in mower deck brackets.

2. Align hole on each side of lower handle with one of three height adjustment holes (D) in mounting brackets.

- Top hole in mounting bracket will be highest handle position.

3. Install carriage bolt outward through hole in each mounting bracket and then through handle. Install lock washers, knobs and tighten to secure.

## Testing Safety Systems

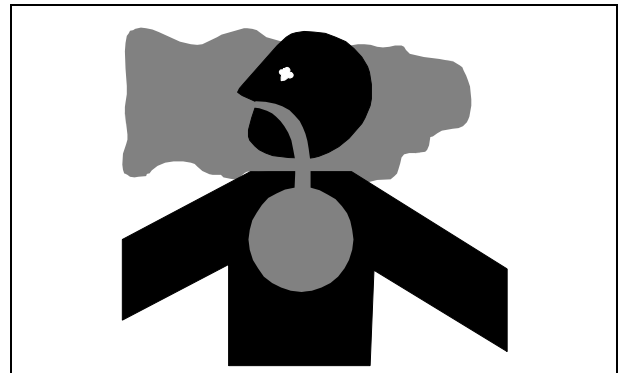

**CAUTION: Avoid injury! Engine exhaust fumes contain carbon monoxide and can cause serious illness or death.**  
**Do not run an engine in an enclosed area, such as a garage, even with doors or windows opened.**  
**Move the machine to an outside area before running the engine.**

The safety systems installed on your machine should be checked before each machine use. Be sure you have read the machine operator manual and are completely familiar with the operation of the machine before performing these safety system checks.

Use the following checkout procedures to check for normal operation of machine.

If there is a malfunction during one of these procedures, do not operate machine. **See your authorized dealer for service.**

Perform these tests in a clear open area. Keep bystanders away.

**<https://www.ebooklibonline.com>**

Hello dear friend!

Thank you very much for reading.

Enter the link into your browser.

The full manual is available for immediate download.

**<https://www.ebooklibonline.com>**