

# **MID-MOUNT ZTRAK M653/655/665**

Serial No. (010001 - )

## **TECHNICAL MANUAL**

**John Deere  
Worldwide Commercial and  
Consumer Equipment Division**

**TM1778 (Sep99)**



MX1835

This technical manual is written for an experienced technician and contains sections that are specifically for this product. It is a part of a total product support program.

The manual is organized so that all the information on a particular system is kept together. The order of grouping is as follows:

- Table of Contents
- General Diagnostic Information
- Specifications
- Electrical Wiring Harness Legend
- Component Location
- System Schematic
- Wiring Harness
- Troubleshooting Chart
- Theory of Operation
- Diagnostics
- Tests & Adjustments
- Repair

*Note: Depending on the particular section or system being covered, not all of the above groups may be used.*

Each section will be identified with a symbol rather than a number. The groups and pages within a section will be consecutively numbered.

We appreciate your input on this manual. To help, there are postage paid post cards included at the back. If you find any errors or want to comment on the layout of the manual please fill out one of the cards and mail it back to us.

All information, illustrations and specifications in this manual are based on the latest information available at the time of publication. The right is reserved to make changes at any time without notice.

COPYRIGHT© 1999  
 Deere & Co.  
 John Deere Worldwide Commercial and  
 Consumer Equipment Division  
 Horicon, WI  
 All rights reserved.

**Safety** 

**Specifications and Information** 

**Engine** 

**Electrical** 

**Hydrostatic Power Train** 

**Brakes** 

**Attachments** 

**Miscellaneous** 

**<https://www.ebooklibonline.com>**

Hello dear friend!

Thank you very much for reading.

Enter the link into your browser.

The full manual is available for immediate download.

**<https://www.ebooklibonline.com>**



## RECOGNIZE SAFETY INFORMATION



This is the safety-alert symbol. When you see this symbol on your machine or in this manual, be alert to the potential for personal injury.

Follow recommended precautions and safe servicing practices.

### Understand Signal Words

A signal word—DANGER, WARNING, or CAUTION—is used with the safety-alert symbol. DANGER identifies the most serious hazards.

DANGER or WARNING safety signs are located near specific hazards. General precautions are listed on CAUTION safety signs. CAUTION also calls attention to safety messages in this manual.

## REPLACE SAFETY SIGNS

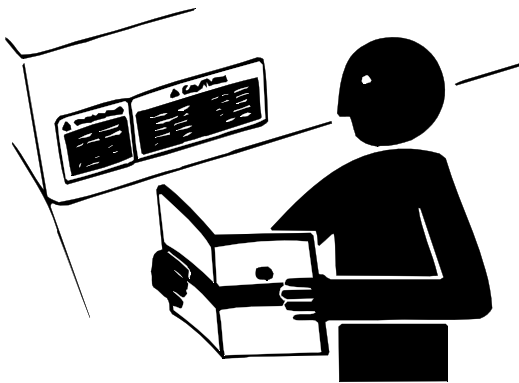

Replace missing or damaged safety signs. See the machine operator's manual for correct safety sign placement.

## HANDLE FLUIDS SAFELY-AVOID FIRES

### Be Prepared For Emergencies

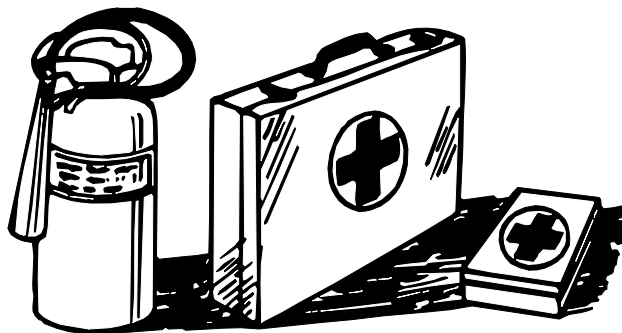

When you work around fuel, do not smoke or work near heaters or other fire hazards.

Store flammable fluids away from fire hazards. Do not incinerate or puncture pressurized containers.

Make sure machine is clean of trash, grease, and debris.

Do not store oily rags; they can ignite and burn spontaneously.

Be prepared if a fire starts.

Keep a first aid kit and fire extinguisher handy.

Keep emergency numbers for doctors, ambulance service, hospital, and fire department near your telephone.

## USE CARE IN HANDLING AND SERVICING BATTERIES

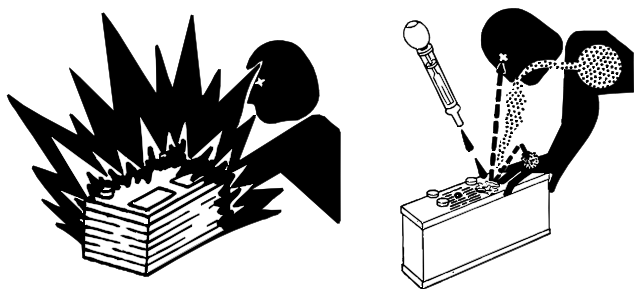

### Prevent Battery Explosions

- Keep sparks, lighted matches, and open flame away from the top of battery. Battery gas can explode.
- Never check battery charge by placing a metal object across the posts. Use a volt-meter or hydrometer.
- Do not charge a frozen battery; it may explode. Warm battery to 16°C (60°F).

### Prevent Acid Burns

- Sulfuric acid in battery electrolyte is poisonous. It is strong enough to burn skin, eat holes in clothing, and cause blindness if splashed into eyes.
- **Avoid acid burns by:**
  1. Filling batteries in a well-ventilated area.
  2. Wearing eye protection and rubber gloves.
  3. Avoiding breathing fumes when electrolyte is added.
  4. Avoiding spilling or dripping electrolyte.
  5. Use proper jump start procedure.
- **If you spill acid on yourself:**
  1. Flush your skin with water.
  2. Apply baking soda or lime to help neutralize the acid.
  3. Flush your eyes with water for 10—15 minutes.
  4. Get medical attention immediately.
- **If acid is swallowed:**
  1. Drink large amounts of water or milk.
  2. Then drink milk of magnesia, beaten eggs, or vegetable oil.
  3. Get medical attention immediately.

## USE CARE AROUND HIGH-PRESSURE FLUID LINES

### Avoid High-pressure Fluids



Escaping fluid under pressure can penetrate the skin causing serious injury.

Avoid injury from escaping fluid under pressure by stopping the engine and relieving pressure in the system before disconnecting or connecting hydraulic or other lines. Tighten all connections before applying pressure.

Search for leaks with a piece of cardboard. Protect hands and body from high pressure fluids.

If an accident occurs, see a doctor immediately. Any fluid injected into the skin must be surgically removed within a few hours or gangrene may result. Doctors unfamiliar with this type of injury should reference a knowledgeable medical source. Such information is available from Deere & Company Medical Department in Moline, Illinois, U.S.A.

### Avoid Heating Near Pressurized Fluid Lines



Flammable spray can be generated by heating near pressurized fluid lines, resulting in severe burns to yourself and bystanders. Do not heat by welding, soldering, or using a torch near pressurized fluid lines or other flammable materials. Pressurized lines can be accidentally cut when heat goes beyond the immediate flame area.





## **USE SAFE SERVICE PROCEDURES**

### **Wear Protective Clothing**

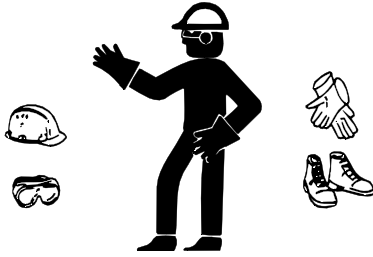

Wear close fitting clothing and safety equipment appropriate to the job.

Prolonged exposure to loud noise can cause impairment or loss of hearing. Wear a suitable hearing protective device such as earmuffs or earplugs to protect against objectionable or uncomfortable loud noises.

Operating equipment safely requires the full attention of the operator. Do not wear radio or music headphones while operating machine.

### **Service Machines Safely**

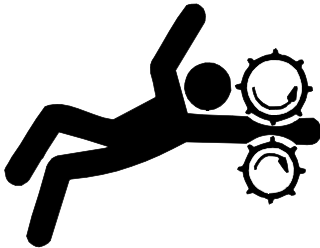

Tie long hair behind your head. Do not wear a necktie, scarf, loose clothing, or necklace when you work near machine tools or moving parts. If these items were to get caught, severe injury could result.

Remove rings and other jewelry to prevent electrical shorts and entanglement in moving parts.

### **Use Proper Tools**

Use tools appropriate to the work. Makeshift tools and procedures can create safety hazards. Use power tools only to loosen threaded parts and fasteners. For loosening and tightening hardware, use the correct size tools. **DO NOT** use U.S. measurement tools on metric fasteners. Avoid bodily injury caused by slipping wrenches. Use only service parts meeting John Deere specifications.

### **Park Machine Safely**

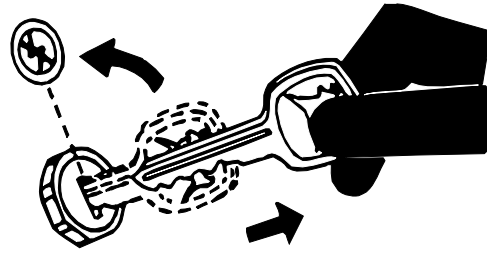

#### **Before working on the machine:**

1. Lower all equipment to the ground.
2. Stop the engine and remove the key.
3. Disconnect the battery ground strap.
4. Hang a "DO NOT OPERATE" tag in operator station.

### **Support Machine Properly And Use Proper Lifting Equipment**

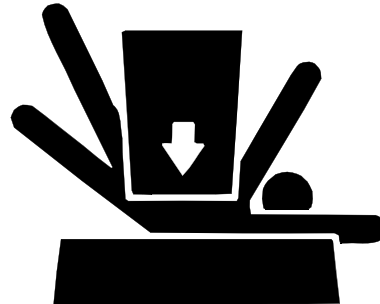

If you must work on a lifted machine or attachment, securely support the machine or attachment.

Do not support the machine on cinder blocks, hollow tiles, or props that may crumble under continuous load. Do not work under a machine that is supported solely by a jack. Follow recommended procedures in this manual.

Lifting heavy components incorrectly can cause severe injury or machine damage. Follow recommended procedure for removal and installation of components in the manual.

### **Work In Clean Area**

#### **Before starting a job:**

1. Clean work area and machine.
2. Make sure you have all necessary tools to do your job.
3. Have the right parts on hand.
4. Read all instructions thoroughly; do not attempt shortcuts.

## Using High Pressure Washers

Directing pressurized water at electronic/electrical components or connectors, bearings, hydraulic seals, fuel injection pumps or other sensitive parts and components may cause product malfunctions. Reduce pressure and spray at a 45 to 90 degree angle.

## Illuminate Work Area Safely

Illuminate your work area adequately but safely. Use a portable safety light for working inside or under the machine. Make sure the bulb is enclosed by a wire cage. The hot filament of an accidentally broken bulb can ignite spilled fuel or oil.

## Work In Ventilated Area

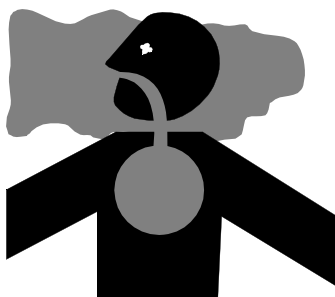

Engine exhaust fumes can cause sickness or death. If it is necessary to run an engine in an enclosed area, remove the exhaust fumes from the area with an exhaust pipe extension.

If you do not have an exhaust pipe extension, open the doors and get outside air into the area.

## WARNING: California Proposition 65 Warning

Diesel engine exhaust and some of its constituents are known to the State of California to cause cancer, birth defects, and other reproductive harm.

Gasoline engine exhaust from this product contains chemicals known to the State of California to cause cancer, birth defects, or other reproductive harm.

## Remove Paint Before Welding Or Heating

Avoid potentially toxic fumes and dust. Hazardous fumes can be generated when paint is heated by welding, soldering, or using a torch. Do all work outside or in a well ventilated area. Dispose of paint and solvent properly. Remove paint before welding or heating: If you sand or grind paint, avoid breathing the dust. Wear an approved respirator. If you use solvent or paint stripper, remove stripper with soap and water before welding. Remove solvent or paint stripper containers and other flammable material from area. Allow fumes to disperse at least 15 minutes before welding or heating.

## Avoid Harmful Asbestos Dust

Avoid breathing dust that may be generated when handling components containing asbestos fibers. Inhaled asbestos fibers may cause lung cancer.

Components in products that may contain asbestos fibers are brake pads, brake band and lining assemblies, clutch plates, and some gaskets. The asbestos used in these components is usually found in a resin or sealed in some way. Normal handling is not hazardous as long as airborne dust containing asbestos is not generated.

Avoid creating dust. Never use compressed air for cleaning. Avoid brushing or grinding material containing asbestos. When servicing, wear an approved respirator. A special vacuum cleaner is recommended to clean asbestos. If not available, apply a mist of oil or water on the material containing asbestos. Keep bystanders away from the area.

## SERVICE TIRES SAFELY

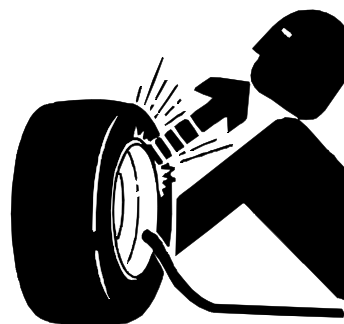

Explosive separation of a tire and rim parts can cause serious injury or death.

Do not attempt to mount a tire unless you have the proper equipment and experience to perform the job. Always maintain the correct tire pressure. Do not inflate the tires above the recommended pressure. Never weld or heat a wheel and tire assembly. The heat can cause an increase in air pressure resulting in a tire explosion. Welding can structurally weaken or deform the wheel.

When inflating tires, use a clip-on chuck and extension hose long enough to allow you to stand to one side and NOT in front of or over the tire assembly. Use a safety cage if available.

Check wheels for low pressure, cuts, bubbles, damaged rims or missing lug bolts and nuts.





**AVOID INJURY FROM ROTATING BLADES, AUGERS AND PTO SHAFTS**



Keep hands and feet away while machine is running. Shut off power to service, lubricate or remove mower blades, augers or PTO shafts.

**HANDLE CHEMICAL PRODUCTS SAFELY**

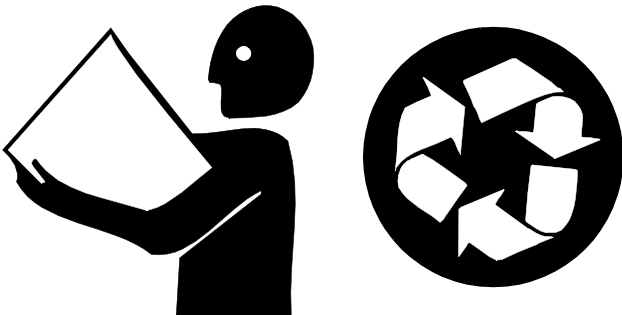

Direct exposure to hazardous chemicals can cause serious injury. Potentially hazardous chemicals used with John Deere equipment include such items as lubricants, coolants, paints, and adhesives.

A Material Safety Data Sheet (MSDS) provides specific details on chemical products: physical and health hazards, safety procedures, and emergency response techniques. Check the MSDS before you start any job using a hazardous chemical. That way you will know exactly what the risks are and how to do the job safely. Then follow procedures and recommended equipment.

**Dispose of Waste Properly**

Improperly disposing of waste can threaten the environment and ecology. Potentially harmful waste used with John Deere equipment include such items as oil, fuel, coolant, brake fluid, filters, and batteries. Use leakproof containers when draining fluids. Do not use food or beverage containers that may mislead someone into drinking from them. Do not pour waste onto the ground, down a drain, or into any water source. Inquire on the proper way to recycle or dispose of waste from your local environmental or recycling center, or from your John Deere dealer.

**LIVE WITH SAFETY**



Before returning machine to customer, make sure machine is functioning properly, especially the safety systems. Install all guards and shields.

## CHECKS, TESTS AND ADJUSTMENTS

### HYDRAULIC SYSTEM BLEEDING PROCEDURE

#### Reason:

To ensure that air is purged from the hydraulic system after the hydraulic hoses have been disconnected.

#### Procedure:

1. Park machine safely.
2. Check level of hydraulic oil. Add oil as needed. (See HYDROSTATIC TRANSMISSION AND HYDRAULIC OIL—NORTH AMERICA in SPECIFICATIONS AND INFORMATION section.)



## CAUTION

Engine exhaust fumes can cause sickness or death.

If it is necessary to run an engine in an enclosed area, use an exhaust pipe extension to remove the fumes.

Always try to work in a well-ventilated area.

3. Start engine and run at SLOW idle (1200 ±75 rpm).
4. Drive machine forward approximately 20 feet, then make two hard left turns, then make two hard right turns.
5. Drive the machine in reverse approximately 10 feet.
6. Turn key switch to STOP position.
7. Check all hoses and connections for leaks. Tighten connections and/or replace hoses as needed.
8. Check oil level at hydraulic oil reservoir. Add oil as needed.

## CONTROL LINKAGE CHECK AND ADJUSTMENT

#### Reason:

To ensure that the machine does not move when the control levers are in the NEUTRAL position, while the engine is running.

#### Check Procedure:



## CAUTION

Engine exhaust fumes can cause sickness or death.

If it is necessary to run an engine in an enclosed area, use an exhaust pipe extension to remove the fumes.

Always try to work in a well-ventilated area.

1. Park machine safely.
2. Move PTO switch to OFF position.
3. With the operator on the seat, start engine.

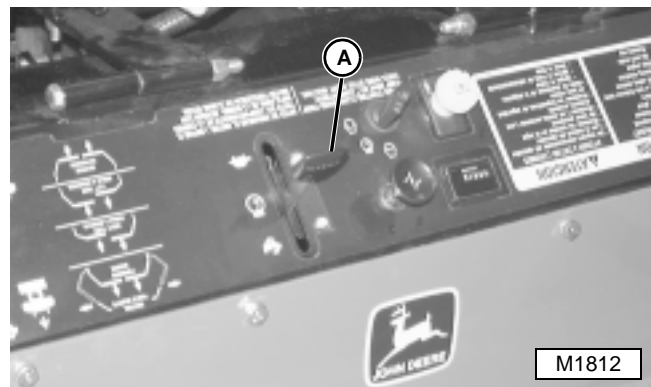

4. Move throttle lever to half-speed position (A).
5. Release park brake.
6. Observe the drive wheels, the wheels should not move.

#### Results:

If movement is noted, perform Adjustment Procedure.

**Adjustment Procedure:**

1. Turn ignition switch to STOP position.
2. Adjust the operator seat to the rearmost position.
3. Engage the park brake.

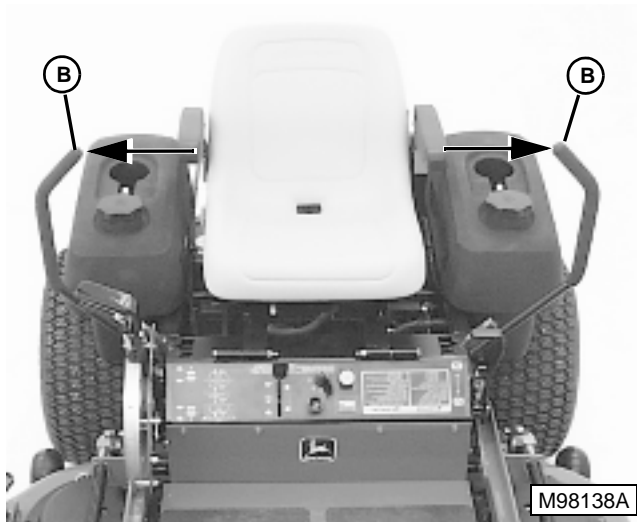

4. Move control levers (B) to NEUTRAL LOCK position.
5. Raise and latch seat platform.

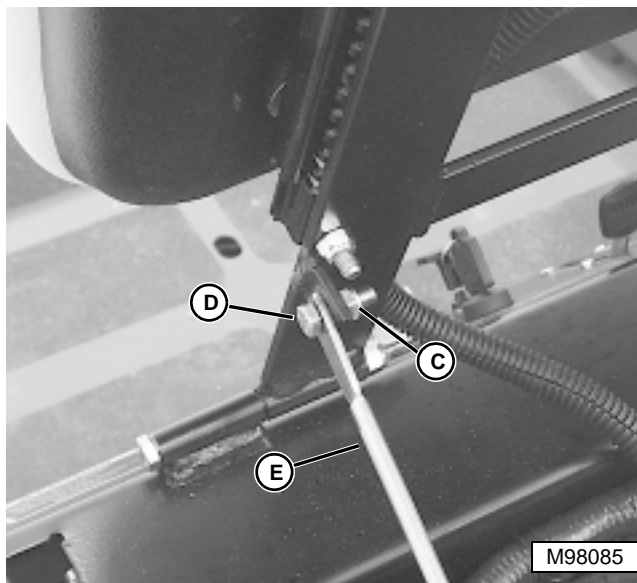

*NOTE: The operator seat must be adjusted completely to the rear to allow access to the console controls when the seat is tilted forward.*

*The cap screw (D) and nut (C) should allow the support rod (E) to roll and pivot freely to ensure proper operation.*

6. Remove lock nut (C), cap screw (D) and support rod (E) from the seat bracket.
7. Tilt the seat forward and allow to rest against the vehicle frame.

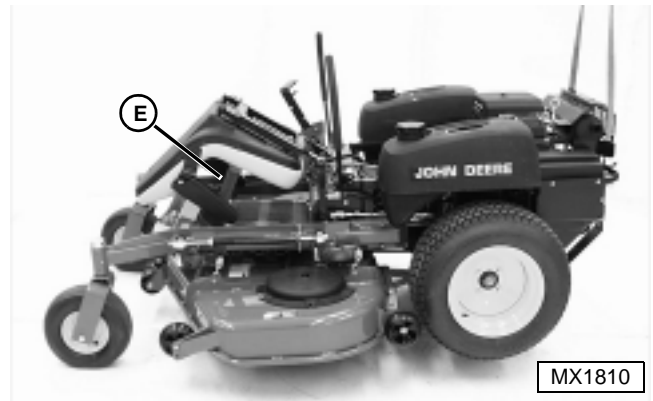

*NOTE: The rear wheels must be able to rotate freely.*

8. Use a safe lifting device to raise the rear of the machine. Support the machine using wood blocks or jackstands.

*NOTE: To prevent damage to the seat bottom, cover the end of the wood block with a rag.*

9. Place a 25—30 cm (10—12 in.) long wood block (E) between the foot plate and the center of the seat bottom to activate the seat safety switch.

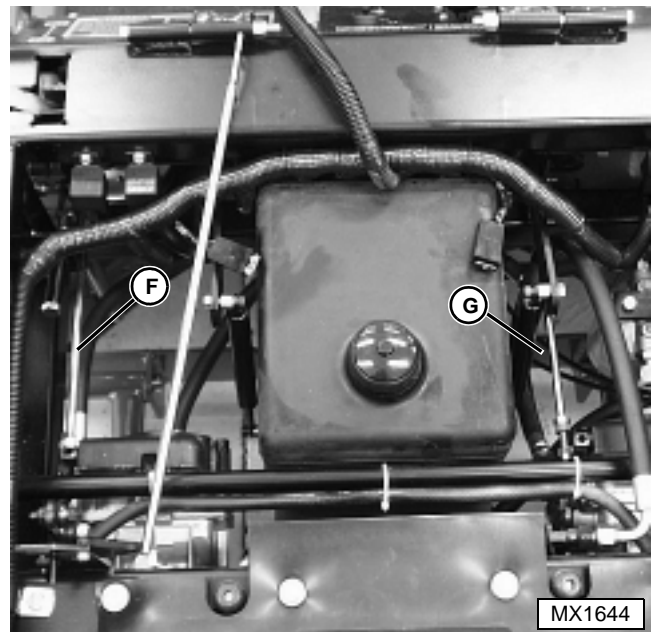

10. Locate the left (F) and right (G) control linkages.

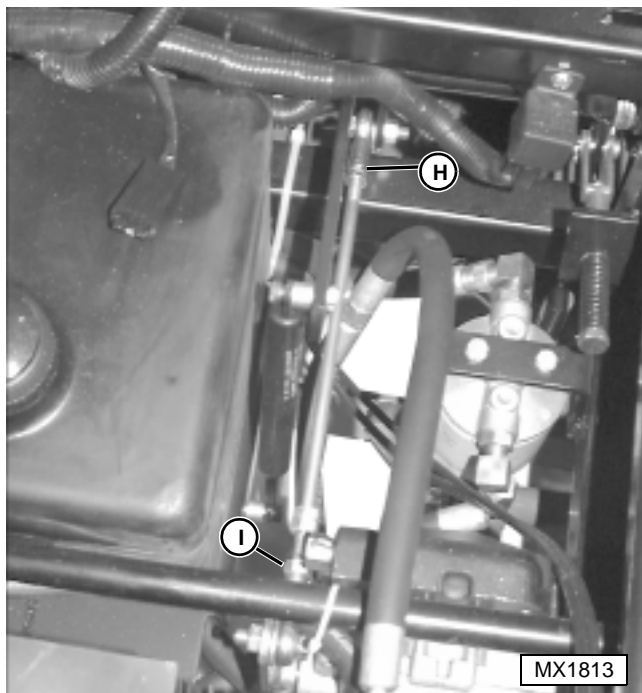

**NOTE:** The hex nut at the front of the linkage has left-hand threads.

11. Loosen the jam nuts (H and I) at the front and rear of the linkage.



## CAUTION

Help prevent serious personal injury. Use caution when performing this service procedure. Keep hands, feet and clothing away from rotating tires.

12. Start engine.
13. Move throttle lever to half-speed position.
14. Release park brake.

**NOTE:** The right and left control levers can be adjusted independently.

15. Move the RIGHT control lever from the NEUTRAL LOCK to the NEUTRAL position.
16. Adjust the RIGHT control linkage, by rotating the double nuts clockwise (or counterclockwise) as needed until no rotation is noted.
17. Move the RIGHT control lever completely forward in the slot and then back to the NEUTRAL position.
18. Observe the drive wheels, no rotation should be noted.
19. Move the RIGHT control lever completely rearward in the slot.

**NOTE:** If the lever fails to return to the NEUTRAL position and the drive wheels continue to rotate, the reverse spring detent may need to be adjusted. (See REVERSE SPRING DETENT CHECK AND ADJUSTMENT.)

20. Release the control lever. The lever should return to the NEUTRAL position, and the drive wheels should stop. Repeat steps 15—20 as needed.
21. Perform steps 15—20 for the LEFT control lever linkage.
22. Tighten the jam nuts at the front and rear of both linkage rods.
23. Install lock nut, cap screw and support rod.

## REVERSE SPRING DETENT CHECK AND ADJUSTMENT

### Reason:

To ensure that the controls levers return to the NEUTRAL position.

### Check Procedure:

1. Park machine safely.

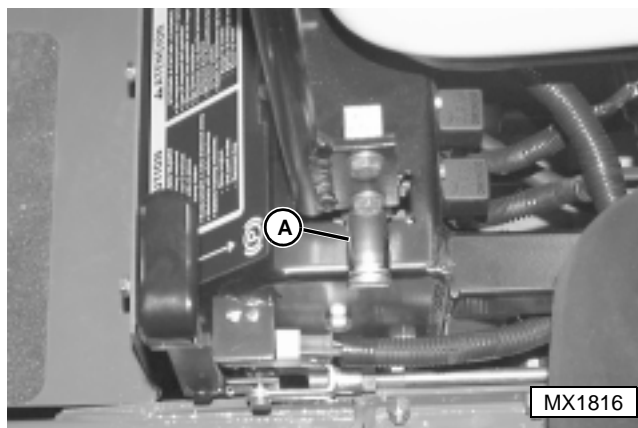

2. Pull both control levers back to the REVERSE position.

**NOTE:** The control levers should be centered in the neutral slot and should be able to be moved to the NEUTRAL LOCK position.

3. Release the levers, the levers should return to the NEUTRAL position (lever centered in the NEUTRAL LOCK slot [A]).

### Results:

If control levers do not return as described, perform Adjustment Procedure.

**Adjustment Procedure:**

1. Adjust the operator seat to the rearmost position.
2. Move control levers to NEUTRAL LOCK position.
3. Raise and latch seat platform.

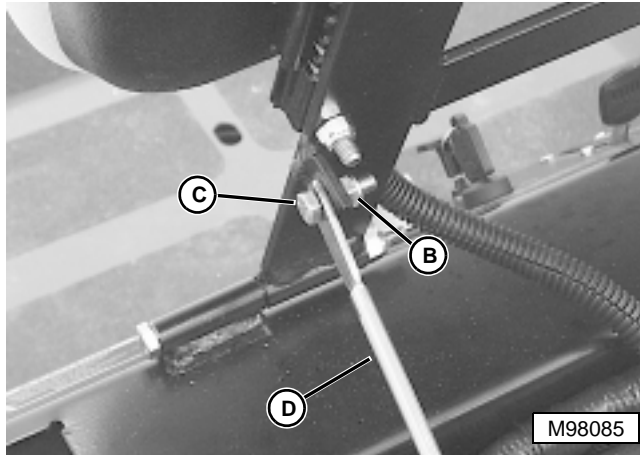

**NOTE:** The operator seat must be adjusted completely to the rear to allow access to the console controls when the seat is tilted forward.

The cap screw (C) and nut (B) should allow the support rod (D) to roll and pivot freely to ensure proper operation.

4. Remove lock nut (B), cap screw (C) and support rod (D) from the seat bracket.
5. Tilt the seat forward and allow to rest against the vehicle frame.

**NOTE:** Right and left control levers can be adjusted independently.

6. Move the RIGHT control lever from the NEUTRAL LOCK to the NEUTRAL position.

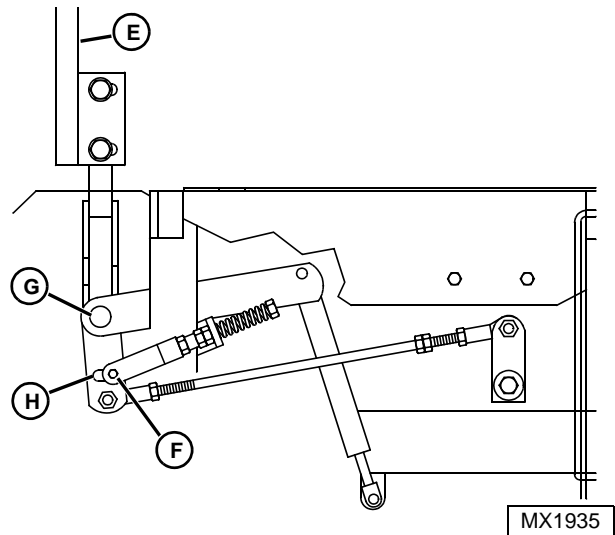

7. Pull the right control lever (E) to the rear until the clevis pin (F) on the arm below the pivot shaft (G) comes into contact with the rear of the slot (H). A slight spring pressure should be felt.

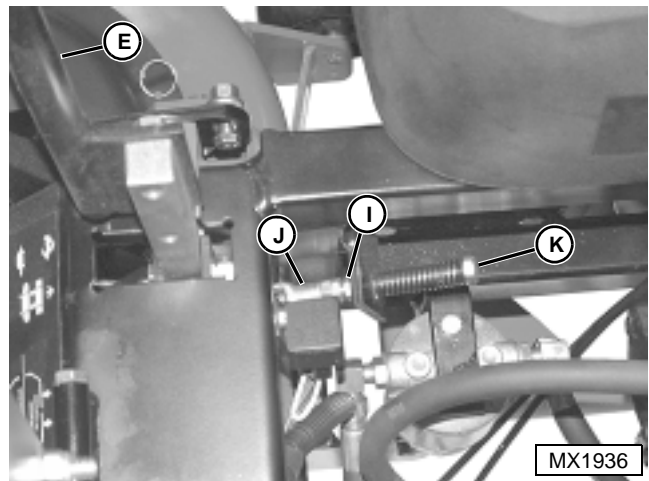

8. Loosen jam nut (I) from the yoke (J).
9. Make sure that the clevis pin (F) is in contact with the rear of the slot.
10. Apply slight rearward pressure to the right control lever (E). Turn the head of the adjustment bolt (K) clockwise (or counterclockwise) as needed until the lever is centered in the neutral slot.
11. Tighten the jam nut (I) against the yoke (J).
12. Repeat adjustment procedure for the LEFT control lever.

**NOTE:** When properly adjusted, the control levers will return to the NEUTRAL position from the REVERSE position and reverse movement will stop when the control levers are released.

13. Check adjustment. (See Check Procedure.)

## CONTROL LEVER ALIGNMENT CHECK AND ADJUSTMENT

### Reason:

To align the control levers.

### Check Procedure:

1. Park machine safely.

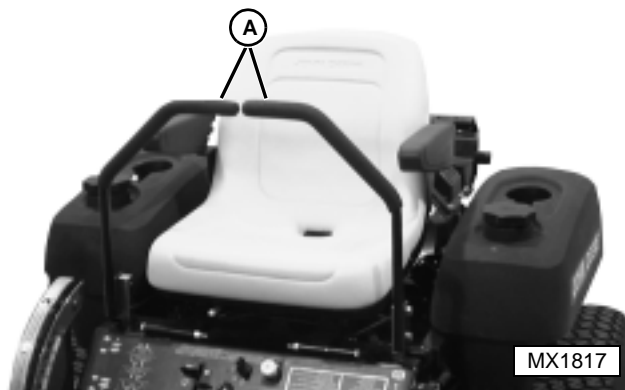

2. Move control levers (A) to NEUTRAL position.



3. Check lever alignment; levers should align with approximately **3—6 mm (0.125—0.25 in.)** gap (B) between the levers. If adjustment is required proceed to Adjustment Procedure.

### Adjustment Procedure:

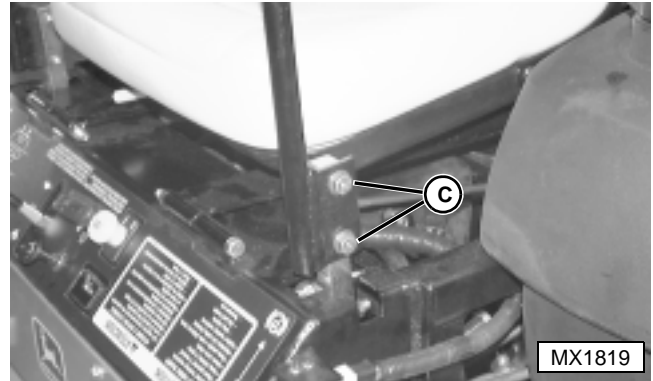

1. Loosen cap screws (C).
2. Slide both levers forward (or backward) as required, until levers are aligned.
3. Tighten cap screws (C).

**NOTE:** If the ends of the levers touch when in the NEUTRAL position, move the levers to the NEUTRAL LOCK position and carefully bend them outward. Move the levers to the NEUTRAL position and check alignment.

4. Check lever alignment. (See Check Procedure.)

## REPAIR

OIL COOLER—  
REMOVAL/INSTALLATION

1. Park machine safely.
2. Raise and latch seat platform.

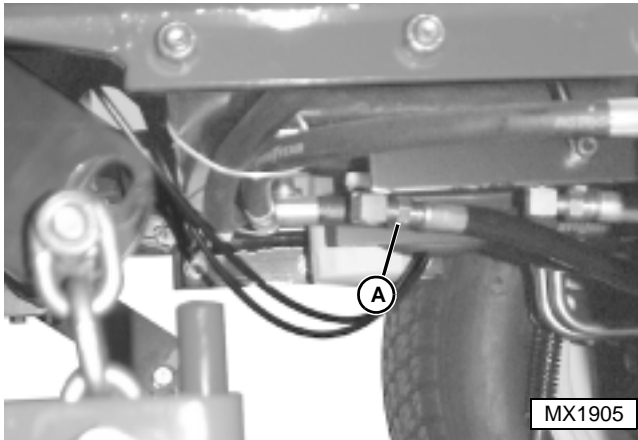

**NOTE:** Hydraulic system oil capacity is approximately 7.6 L (2.0 gal.).

3. Disconnect oil line (A) at reservoir and drain reservoir into a clean container.

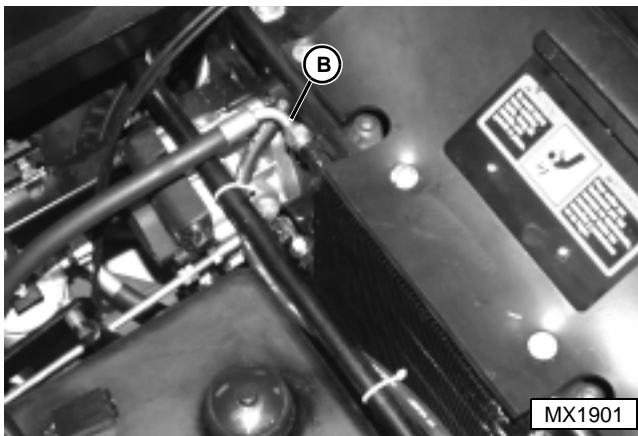

**IMPORTANT:** Use a wrench to hold fitting on oil cooler when loosening or tightening hose connections, to prevent twisting the fitting.

4. Disconnect oil hose (B).

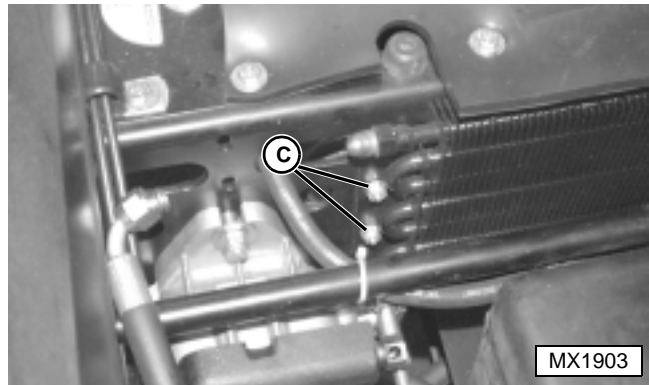
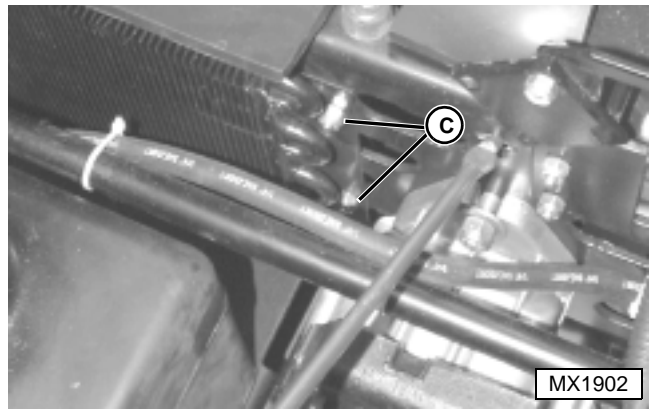

5. Remove four caps screws and nuts (C) (two each side).
6. Remove oil cooler.
7. Inspect oil cooler. (See OIL COOLER—INSPECTION.)

**Installation is done in the reverse order of removal.**

**NOTE:** Hydraulic oil drained from the system can be reused if the oil is clean and free of contaminants. Use a strainer when filling reservoir.

- Fill hydraulic reservoir to correct level with oil of proper specifications. (See HYDROSTATIC TRANSMISSION AND HYDRAULIC OIL—NORTH AMERICA in SPECIFICATIONS AND INFORMATION section.)
- Bleed air from hydraulic system. (See HYDRAULIC SYSTEM BLEEDING PROCEDURE.)

### OIL COOLER—INSPECTION

## CAUTION

Reduce compressed air to less than 210 kPa (2 bar) (30 psi) when using for cleaning purposes. Clear area of bystanders, guard against flying chips, and wear personal protection equipment including eye protection.

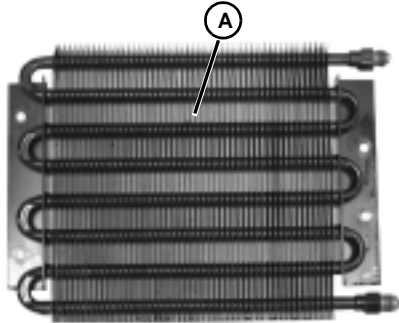

MX1904

1. Check oil cooler for debris lodged in the fins (A). Clean oil cooler using compressed air or pressure washer.
2. Inspect oil cooler for bent fins, cracks and damaged seams. Repair or replace oil cooler as needed.

### HYDRAULIC PUMP DRIVE BELT—REMOVAL/INSTALLATION

1. Park machine safely.
2. Raise and latch seat platform.

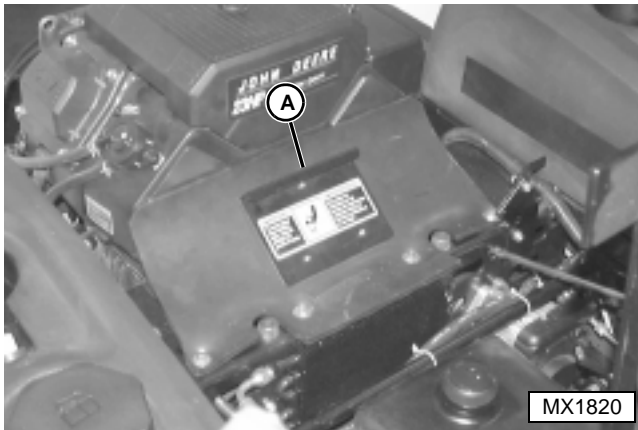

MX1820

3. Open rubber access door (A).

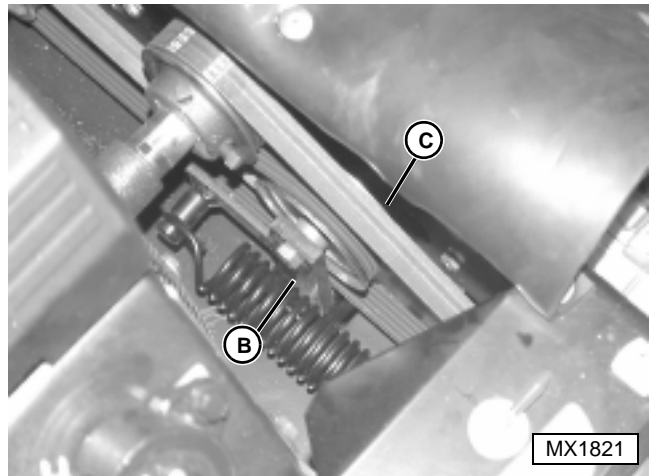

MX1821

4. Relieve belt tension by using a pry bar to move the belt tensioner bracket (B).
5. Remove the drive belt (C).
6. Inspect the belt for cracks, damage or signs of wear. Replace as needed.

Installation is done in the reverse order of removal.

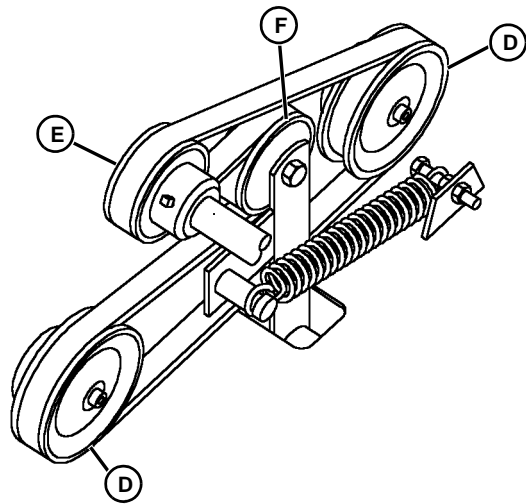

- Route belt around hydraulic pump sheaves (D), PTO shaft sheave (E) and idler sheave (F).

HYDRAULIC PUMP DRIVE BELT TENSIONER ASSEMBLY—REPAIR

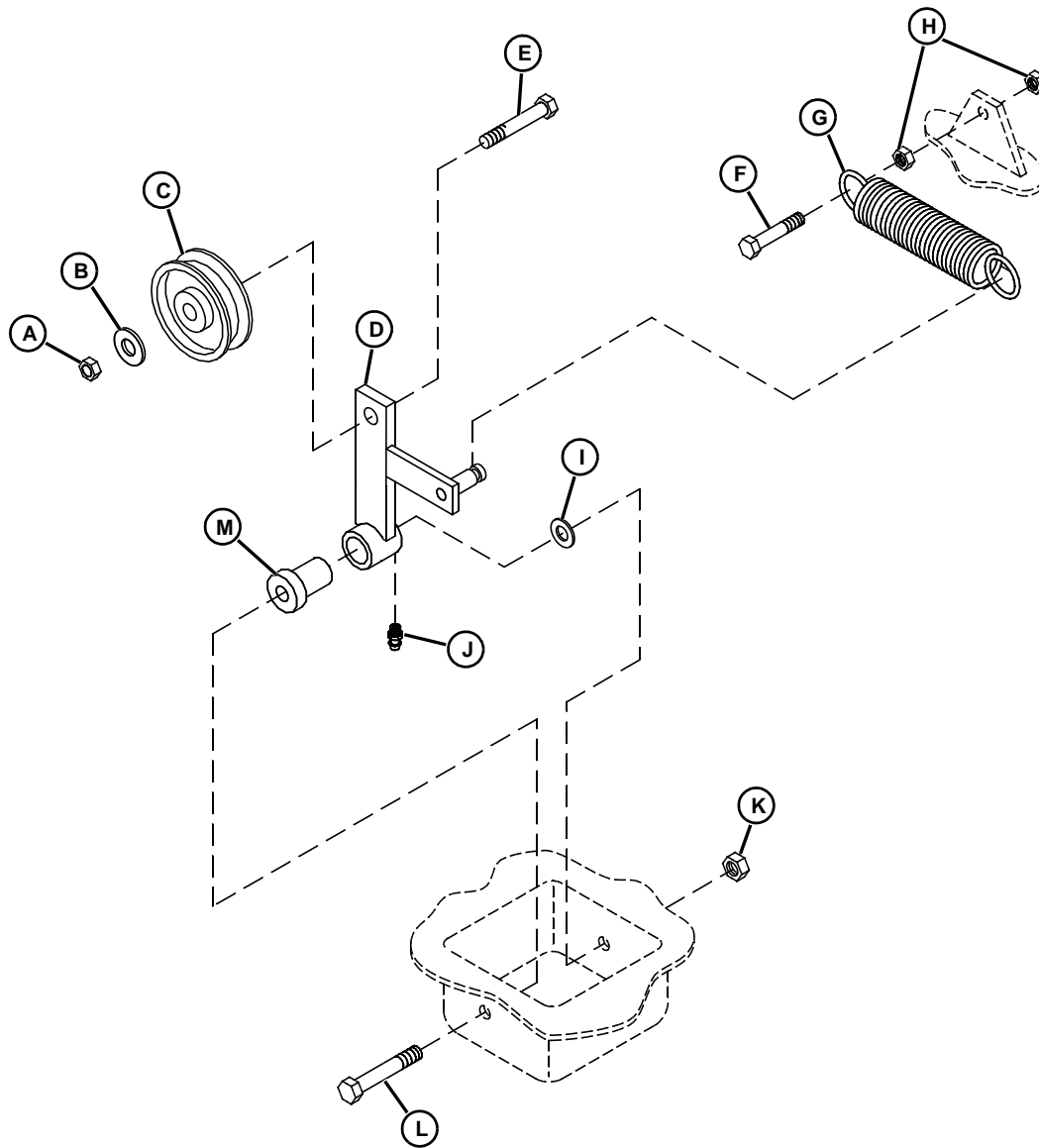

MX1923

- |                   |                |                       |           |
|-------------------|----------------|-----------------------|-----------|
| A—Nut             | E—Cap Screw    | I—Washer              | M—Bushing |
| B—Washer          | F—Cap Screw    | J—Lubrication Fitting |           |
| C—Sheave          | G—Spring       | K—Nut                 |           |
| D—Tension Bracket | H—Nut (2 Used) | L—Cap Screw           |           |

- Inspect all parts for wear or damage. Replace parts as needed.
- Apply grease to lubrication fitting. (See CHASSIS AND MOWER SPINDLE GREASE in SPECIFICATIONS AND INFORMATION section.)

CONTROL LEVER LINKAGE—REPAIR

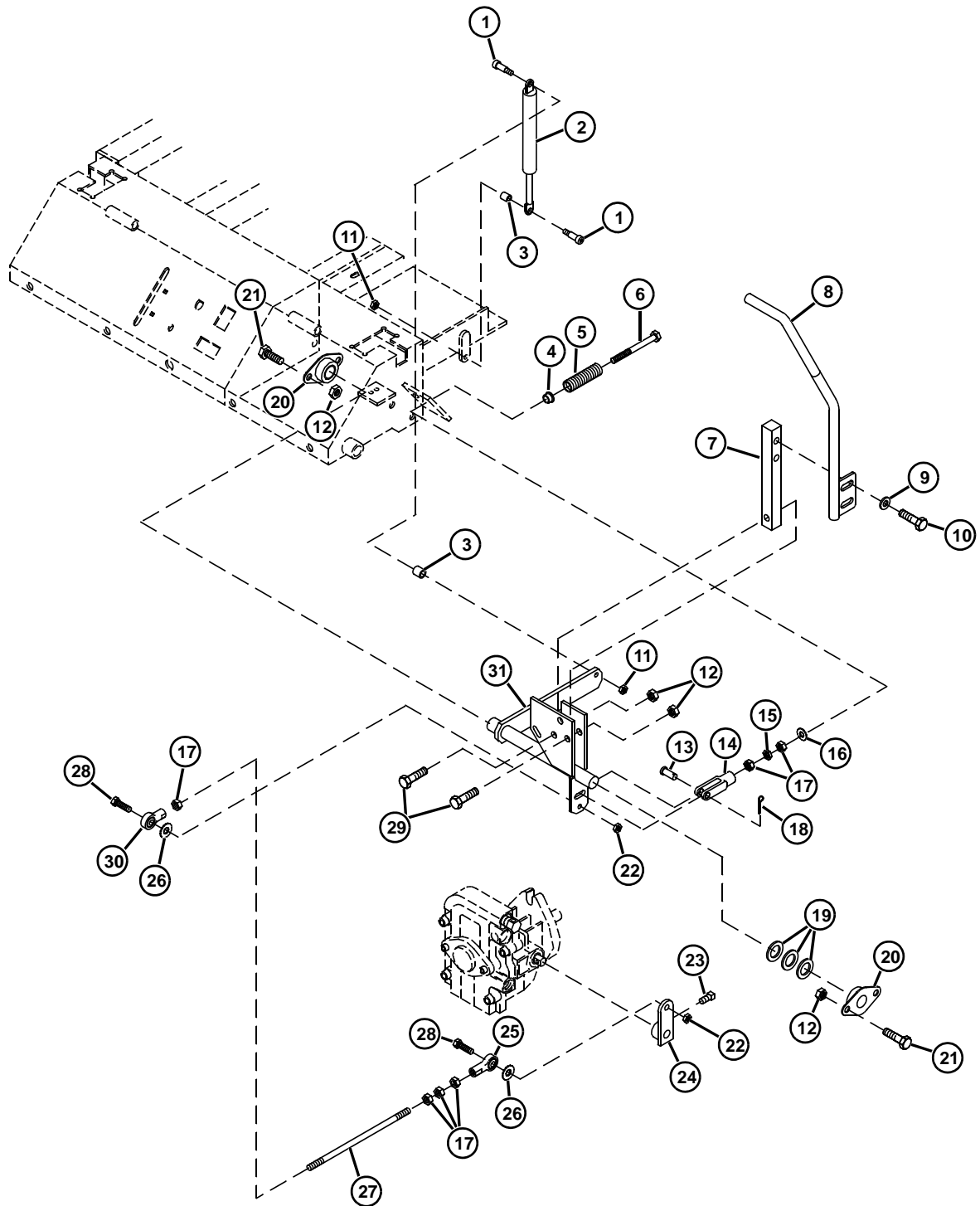

MX1929

1—Cap Screw (2 Used)	17—Nut (5 Used)
2—Dampener	18—Cotter Pin
3—Spacer (2 Used)	19—Washers (3 Used)
4—Bushing	20—Bearing (2 Used)
5—Spring	21—Cap Screw (4 Used)
6—Cap Screw	22—Lock Nut (2 Used)
7—Arm	23—Set Screw
8—Control Lever	24—Arm
9—Spring Washer (2 Used)	25—Ball Joint
10—Cap Screw (2 Used)	26—Washer (2 Used)
11—Flanged Nut (2 Used)	27—Link
12—Lock Nut (7 Used)	28—Cap Screw (2 Used)
13—Pin	29—Cap Screw (3 Used)
14—Yoke	30—Ball Joint
15—Nut	31—Bracket
16—Washer	

*NOTE: Right control lever mechanism shown. Left control lever mechanism is the same.*

*Quantities shown are per side.*

- Inspect all parts for wear or damage. Replace parts as needed.
- Adjust control lever height. (See CONTROL LEVER HEIGHT ADJUSTMENT.)
- Adjust control linkage. (See CONTROL LINKAGE CHECK AND ADJUSTMENT.)





**Suggest:**

**If the above button click is invalid.**

**Please download this document**

**first, and then click the above link**

**to download the complete manual.**

**Thank you so much for reading**

## HYDRAULIC PUMPS— REMOVAL/INSTALLATION

### CAUTION

Escaping fluid under pressure can penetrate the skin causing serious injury. Avoid the hazard by relieving pressure before disconnecting any hoses. Tighten all connections before applying pressure. Search for leaks with a piece of cardboard. Protect hands and body from high pressure fluids.

If an accident occurs, see a doctor immediately. Any fluid injected into the skin must be removed within a few hours or gangrene may result. Doctors unfamiliar with this type of injury may call Deere & Company Medical Department in Moline, Illinois, or other knowledgeable medical source.

- 
1. Remove drive wheel(s). (See DRIVE WHEELS—REMOVAL/INSTALLATION in MISCELLANEOUS section.)
  2. Remove pump drive belt. (See HYDRAULIC PUMP DRIVE BELT—REMOVAL/INSTALLATION.)

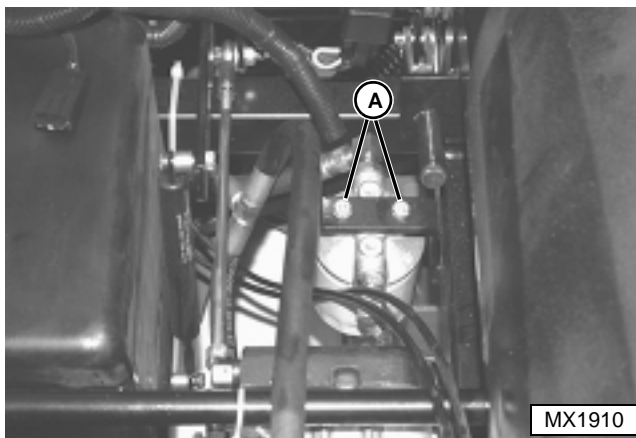

3. **Right Pump Only:** Remove two cap screws (A) from oil filter bracket, and allow the oil filter to drop down to provide clearance.

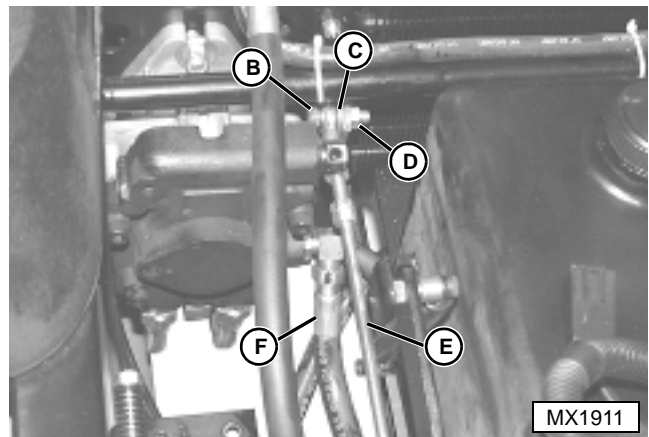

4. Remove cap screw (B), washer (C) and nut (D).
5. Disconnect linkage (E).
6. Disconnect hose (F).

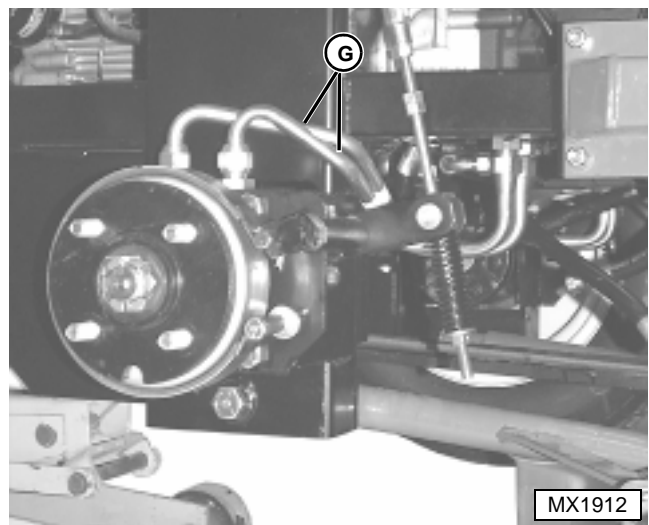

7. Remove hydraulic pump-to-wheel motor hydraulic lines (G).

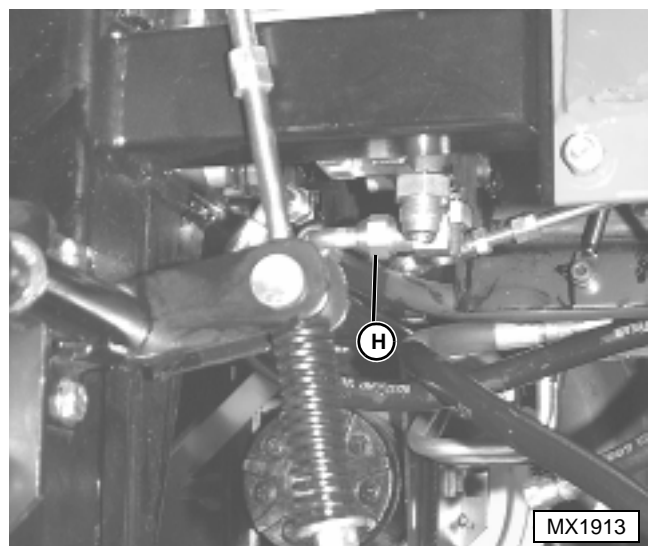

8. Disconnect hose (H).

**<https://www.ebooklibonline.com>**

Hello dear friend!

Thank you very much for reading.

Enter the link into your browser.

The full manual is available for immediate download.

**<https://www.ebooklibonline.com>**