

JOHN DEERE
WORLDWIDE COMMERCIAL & CONSUMER
EQUIPMENT DIVISION

Garden Tractors
LX280, LX280AWS and LX289

TM2046 MARCH 2005

TECHNICAL MANUAL



JOHN DEERE

North American Version
Litho in U.S.A.

INTRODUCTION

Manual Description

This technical manual is written for an experienced technician and contains sections that are specifically for this product. It is a part of a total product support program.

The manual is organized so that all the information on a particular system is kept together. The order of grouping is as follows:

- Table of Contents
- Specifications and Information
- Identification Numbers
- Tools and Materials
- Component Location
- Schematics and Harnesses
- Theory of Operation
- Operation and Diagnostics
- Diagnostics
- Tests and Adjustments
- Repair
- Other

NOTE: Depending on the particular section or system being covered, not all of the above groups may be used.

The bleed tabs for the pages of each section will align with the sections listed on this page. Page numbering is consecutive from the beginning of the Safety section through the last section.

We appreciate your input on this manual. If you find any errors or want to comment on the layout of the manual please contact us.

Safety

Specifications and Information

Engine - FD501V

Engine - FH580V

Electrical

Power Train

Steering

Attachments

Miscellaneous

All information, illustrations and specifications in this manual are based on the latest information at the time of publication. The right is reserved to make changes at any time without notice.

COPYRIGHT© 2005
Deere & Co.
John Deere Worldwide Commercial and
Consumer Equipment Division
All rights reserved
Previous Editions

SAFETY

Recognize Safety Information



MIF

This is the safety-alert symbol. When you see this symbol on your machine or in this manual, be alert to the potential for personal injury.

Follow recommended precautions and safe servicing practices.

Understand Signal Words

A signal word - DANGER, WARNING, or CAUTION - is used with the safety-alert symbol. DANGER identifies the most serious hazards.

DANGER or WARNING safety signs are located near specific hazards. General precautions are listed on CAUTION safety signs. CAUTION also calls attention to safety messages in this manual.

Replace Safety Signs

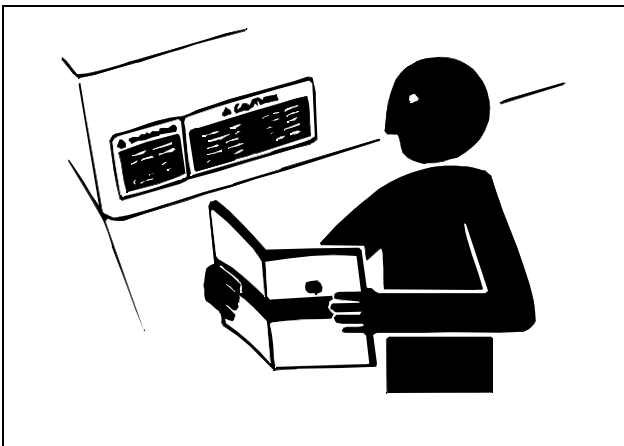

MIF

Replace missing or damaged safety signs. See the machine operator's manual for correct safety sign placement.

Handle Fluids Safely - Avoid Fires

Be Prepared For Emergencies

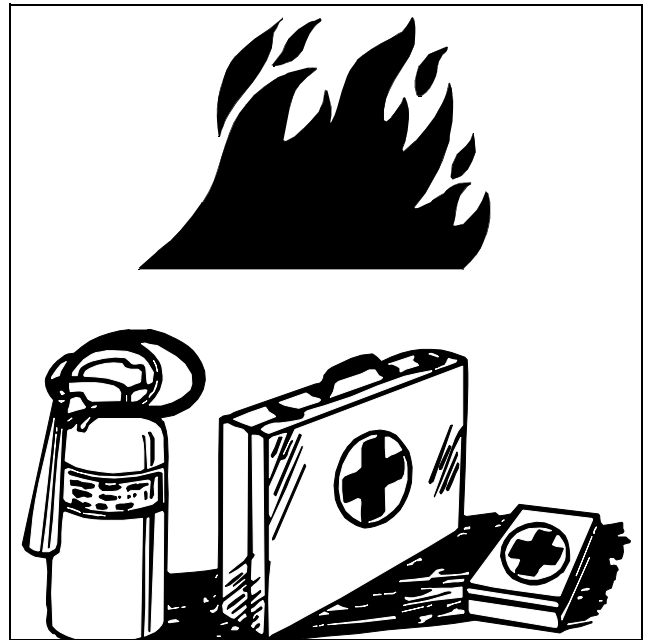

MIF

- When you work around fuel, do not smoke or work near heaters or other fire hazards.
- Store flammable fluids away from fire hazards. Do not incinerate or puncture pressurized containers.
- Make sure machine is clean of trash, grease, and debris.
- Do not store oily rags; they can ignite and burn spontaneously.
- Be prepared if a fire starts.
- Keep a first aid kit and fire extinguisher handy.
- Keep emergency numbers for doctors, ambulance service, hospital, and fire department near your telephone.

Use Care In Handling and Servicing Batteries

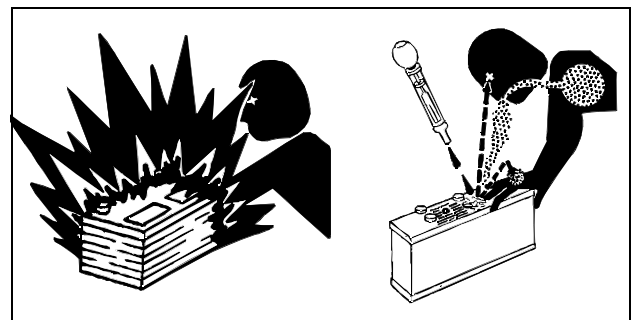

MIF

<https://www.ebooklibonline.com>

Hello dear friend!

Thank you very much for reading.

Enter the link into your browser.

The full manual is available for immediate download.

<https://www.ebooklibonline.com>

SAFETY

Prevent Battery Explosions

- Keep sparks, lighted matches, and open flame away from the top of battery. Battery gas can explode.
- Never check battery charge by placing a metal object across the posts. Use a volt-meter or hydrometer.
- Do not charge a frozen battery; it may explode. Warm battery to 16°C (60°F).

Prevent Acid Burns

- Sulfuric acid in battery electrolyte is poisonous. It is strong enough to burn skin, eat holes in clothing, and cause blindness if splashed into eyes.

Avoid acid burns by:

1. Filling batteries in a well-ventilated area.
2. Wearing eye protection and rubber gloves.
3. Avoiding breathing fumes when electrolyte is added.
4. Avoiding spilling or dripping electrolyte.
5. Use proper jump start procedure.

If you spill acid on yourself:

1. Flush your skin with water.
2. Apply baking soda or lime to help neutralize the acid.
3. Flush your eyes with water for 10 - 15 minutes.
4. Get medical attention immediately.

If acid is swallowed:

1. Drink large amounts of water or milk.
2. Then drink milk of magnesia, beaten eggs, or vegetable oil.
3. Get medical attention immediately.

Wear Protective Clothing

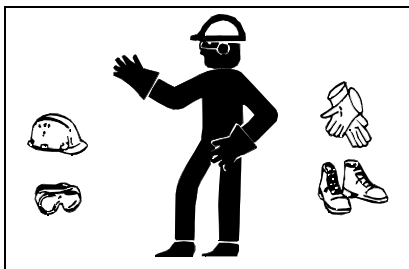

MIF

Wear close fitting clothing and safety equipment appropriate to the job.

Prolonged exposure to loud noise can cause impairment or loss of hearing. Wear a suitable hearing protective device

such as earmuffs or earplugs to protect against objectionable or uncomfortable loud noises.

Operating equipment safely requires the full attention of the operator. Do not wear radio or music headphones while operating machine.

Use Care Around High-pressure Fluid Lines

Avoid High-Pressure Fluids

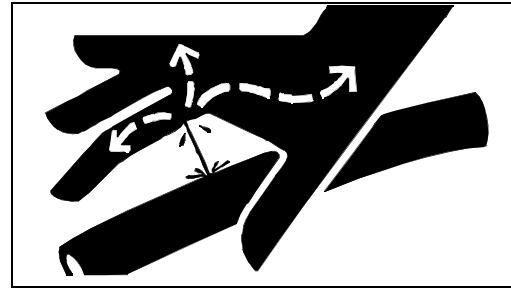

MIF

Escaping fluid under pressure can penetrate the skin causing serious injury.

Avoid injury from escaping fluid under pressure by stopping the engine and relieving pressure in the system before disconnecting or connecting hydraulic or other lines. Tighten all connections before applying pressure.

Search for leaks with a piece of cardboard. Protect hands and body from high pressure fluids.

If an accident occurs, see a doctor immediately. Any fluid injected into the skin must be surgically removed within a few hours or gangrene may result. Doctors unfamiliar with this type of injury should reference a knowledgeable medical source. Such information is available from Deere & Company Medical Department in Moline, Illinois, U.S.A.

Avoid Heating Near Pressurized Fluid Lines



MIF

Flammable spray can be generated by heating near pressurized fluid lines, resulting in severe burns to yourself and bystanders. Do not heat by welding, soldering, or using a torch near pressurized fluid lines or other flammable materials. Pressurized lines can be accidentally cut when heat goes beyond the immediate flame area.

SAFETY

Service Machines Safely

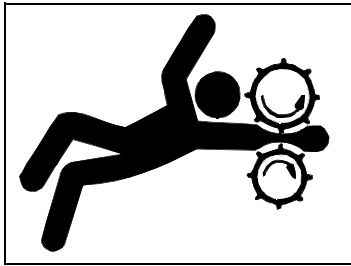

MIF

Tie long hair behind your head. Do not wear a necktie, scarf, loose clothing, or necklace when you work near machine tools or moving parts. If these items were to get caught, severe injury could result.

Remove rings and other jewelry to prevent electrical shorts and entanglement in moving parts.

Use Proper Tools

Use tools appropriate to the work. Makeshift tools and procedures can create safety hazards. Use power tools only to loosen threaded parts and fasteners. For loosening and tightening hardware, use the correct size tools. **DO NOT** use U.S. measurement tools on metric fasteners. Avoid bodily injury caused by slipping wrenches. Use only service parts meeting John Deere specifications.

Park Machine Safely

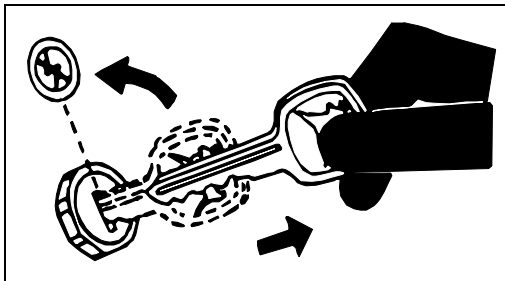

MIF

Before working on the machine:

1. Lower all equipment to the ground.
2. Stop the engine and remove the key.
3. Disconnect the battery ground strap.
4. Hang a "DO NOT OPERATE" tag in operator station.

Support Machine Properly and Use Proper Lifting Equipment

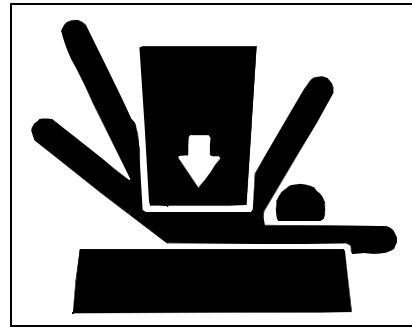

MIF

If you must work on a lifted machine or attachment, securely support the machine or attachment.

Do not support the machine on cinder blocks, hollow tiles, or props that may crumble under continuous load. Do not work under a machine that is supported solely by a jack. Follow recommended procedures in this manual.

Lifting heavy components incorrectly can cause severe injury or machine damage. Follow recommended procedure for removal and installation of components in the manual.

Work In Clean Area

Before starting a job:

1. Clean work area and machine.
2. Make sure you have all necessary tools to do your job.
3. Have the right parts on hand.
4. Read all instructions thoroughly; do not attempt shortcuts.

Using High Pressure Washers

Directing pressurized water at electronic/electrical components or connectors, bearings, hydraulic seals, fuel injection pumps or other sensitive parts and components may cause product malfunctions. Reduce pressure and spray at a 45 to 90 degree angle.

Illuminate Work Area Safely

Illuminate your work area adequately but safely. Use a portable safety light for working inside or under the machine. Make sure the bulb is enclosed by a wire cage. The hot filament of an accidentally broken bulb can ignite spilled fuel or oil.

SAFETY

Work In Ventilated Area

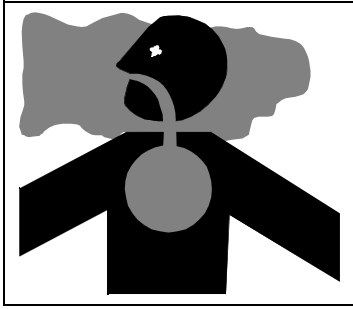

MIF

Engine exhaust fumes can cause sickness or death. If it is necessary to run an engine in an enclosed area, remove the exhaust fumes from the area with an exhaust pipe extension.

If you do not have an exhaust pipe extension, open the doors and get outside air into the area.

Warning: California Proposition 65 Warning

Gasoline engine exhaust from this product contains chemicals known to the State of California to cause cancer, birth defects, or other reproductive harm.

Diesel engine exhaust and some of its constituents are known to the State of California to cause cancer, birth defects, and other reproductive harm.

Remove Paint Before Welding or Heating

Avoid potentially toxic fumes and dust. Hazardous fumes can be generated when paint is heated by welding, soldering, or using a torch. Do all work outside or in a well ventilated area. Dispose of paint and solvent properly. Remove paint before welding or heating: If you sand or grind paint, avoid breathing the dust. Wear an approved respirator. If you use solvent or paint stripper, remove stripper with soap and water before welding. Remove solvent or paint stripper containers and other flammable material from area. Allow fumes to disperse at least 15 minutes before welding or heating.

Avoid Harmful Asbestos Dust

Avoid breathing dust that may be generated when handling components containing asbestos fibers. Inhaled asbestos fibers may cause lung cancer.

Components in products that may contain asbestos fibers are brake pads, brake band and lining assemblies, clutch plates, and some gaskets. The asbestos used in these components is usually found in a resin or sealed in some way. Normal handling is not hazardous as long as airborne dust containing asbestos is not generated.

Avoid creating dust. Never use compressed air for cleaning. Avoid brushing or grinding material containing asbestos. When servicing, wear an approved respirator. A special vacuum cleaner is recommended to clean asbestos. If not available, apply a mist of oil or water on the material containing asbestos. Keep bystanders away from the area.

Service Tires Safely

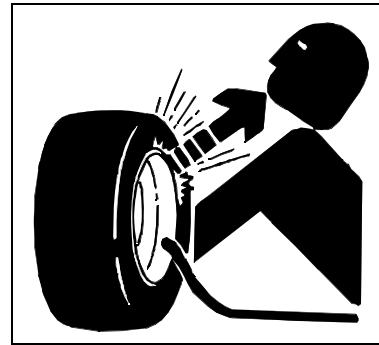

MIF

Explosive separation of a tire and rim parts can cause serious injury or death.

Do not attempt to mount a tire unless you have the proper equipment and experience to perform the job.

Always maintain the correct tire pressure. Do not inflate the tires above the recommended pressure. Never weld or heat a wheel and tire assembly. The heat can cause an increase in air pressure resulting in a tire explosion. Welding can structurally weaken or deform the wheel.

When inflating tires, use a clip-on chuck and extension hose long enough to allow you to stand to one side and NOT in front of or over the tire assembly. Use a safety cage if available.

Check wheels for low pressure, cuts, bubbles, damaged rims or missing lug bolts and nuts.

SAFETY

Avoid Injury From Rotating Blades, Augers and PTO Shafts

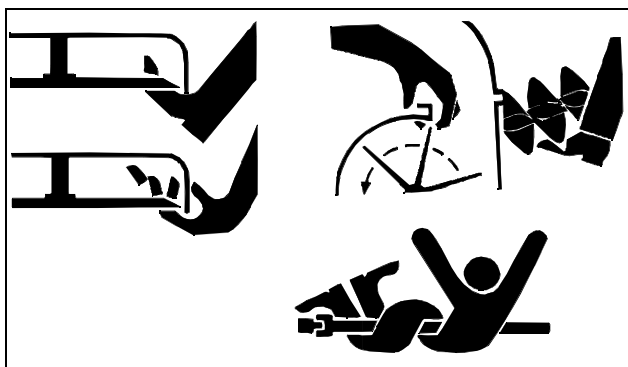

MIF

Keep hands and feet away while machine is running. Shut off power to service, lubricate or remove mower blades, augers or PTO shafts.

Service Cooling System Safely

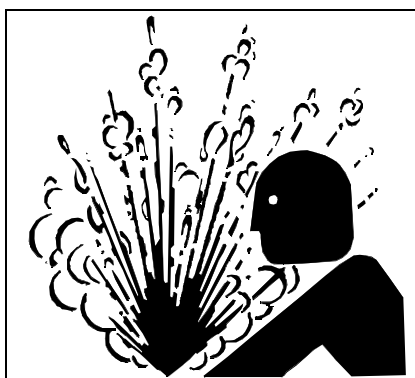

MIF

Explosive release of fluids from pressurized cooling system can cause serious burns.

Shut off machine. Only remove filler cap when cool enough to touch with bare hands. Slowly loosen cap to first stop to relieve pressure before removing completely.

Handle Chemical Products Safely

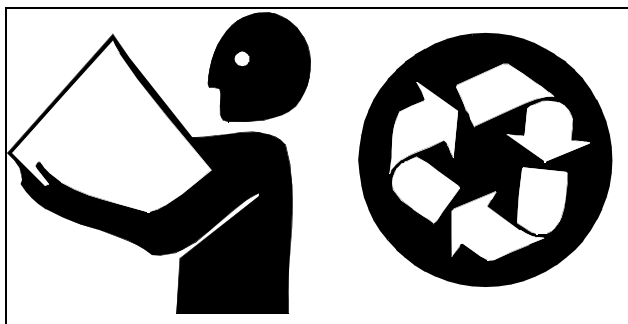

MIF

Direct exposure to hazardous chemicals can cause serious injury. Potentially hazardous chemicals used with John Deere equipment include such items as lubricants, coolants, paints, and adhesives.

A Material Safety Data Sheet (MSDS) provides specific details on chemical products: physical and health hazards, safety procedures, and emergency response techniques. Check the MSDS before you start any job using a hazardous chemical. That way you will know exactly what the risks are and how to do the job safely. Then follow procedures and recommended equipment.

Dispose of Waste Properly

Improperly disposing of waste can threaten the environment and ecology. Potentially harmful waste used with John Deere equipment include such items as oil, fuel, coolant, brake fluid, filters, and batteries. Use leakproof containers when draining fluids. Do not use food or beverage containers that may mislead someone into drinking from them. Do not pour waste onto the ground, down a drain, or into any water source. Inquire on the proper way to recycle or dispose of waste from your local environmental or recycling center, or from your John Deere dealer.

Live With Safety



MIF

Before returning machine to customer, make sure machine is functioning properly, especially the safety systems. Install all guards and shields.

SPECIFICATIONS & INFORMATION TABLE OF CONTENTS

Table of Contents

Fastener Torques	9
Metric Fastener Torque Values	9
Inch Fastener Torque Values	10
O-Ring Seal Service	11
Face Seal Fittings With Inch	
Stud Ends Torque	11
Face Seal Fittings With Metric	
Stud Ends Torque	12
O-ring Face Seal Fittings.....	13
O-Ring Boss Fittings	13
Straight Fitting or Special Nut Torques	14
Metric Fastener Torque Value -	
Grade 7 (Special)	14
General Information	14
Gasoline	14
Gasoline Storage.....	15
4 - Cycle Gasoline Engine Oil	15
Break-In Engine Oil - 4-Cycle Gasoline.....	15
Hydrostatic Transmission and	
Hydraulic Oil	16
Oil Filters	16
Alternative Lubricants.....	16
Synthetic Lubricants	16
Lubricant Storage	16
Mixing of Lubricants	17
Coolant Specifications	17
Gasoline Engine Coolant.....	17
Gasoline Engine Coolant Drain Interval	17
Serial Number Locations	18
Product Serial Number	18
Gasoline Engine Serial Number Location	18

SPECIFICATIONS & INFORMATION FASTENER TORQUES

Fastener Torques

Metric Fastener Torque Values

Property Class and Head Markings				
Property Class and Nut Markings				

MIF

SIZE	Class 4.8				Class 8.8 or 9.8				Class 10.9				Class 12.9			
	Lubricated a		Dry a		Lubricated a		Dry a		Lubricated a		Dry a		Lubricated a		Dry a	
	N•m	lb-ft	N•m	lb-ft	N•m	lb-ft	N•m	lb-ft	N•m	lb-ft	N•m	lb-ft	N•m	lb-ft	N•m	lb-ft
M6	4.8	3.5	6	4.5	9	6.5	11	8.5	13	9.5	17	12	15	11.5	19	14.5
M8	12	8.5	15	11	22	16	28	20	32	24	40	30	37	28	47	35
M10	23	17	29	21	43	32	55	40	63	47	80	60	75	55	95	70
M12	40	29	50	37	75	55	95	70	110	80	140	105	130	95	165	120
M14	63	47	80	60	120	88	150	110	175	130	225	165	205	150	260	109
M16	100	73	125	92	190	140	240	175	275	200	350	225	320	240	400	300
M18	135	100	175	125	260	195	330	250	375	275	475	350	440	325	560	410
M20	190	140	240	180	375	275	475	350	530	400	675	500	625	460	800	580
M22	260	190	330	250	510	375	650	475	725	540	925	675	850	625	1075	800
M24	330	250	425	310	650	475	825	600	925	675	1150	850	1075	800	1350	1000
M27	490	360	625	450	950	700	1200	875	1350	1000	1700	1250	1600	1150	2000	1500
M30	675	490	850	625	1300	950	1650	1200	1850	1350	2300	1700	2150	1600	2700	2000
M33	900	675	1150	850	1750	1300	2200	1650	2500	1850	3150	2350	2900	2150	3700	2750
M36	1150	850	1450	1075	2250	1650	2850	2100	3200	2350	4050	3000	3750	2750	4750	3500

DO NOT use these hand torque values if a different torque value or tightening procedure is given for a specific application. Torque values listed are for general use only and include a ±10% variance factor. Check tightness of fasteners periodically. DO NOT use air powered wrenches.

Shear bolts are designed to fail under predetermined loads. Always replace shear bolts with identical grade.

Fasteners should be replaced with the same grade. Make sure fastener threads are clean and that you properly start thread engagement. This will prevent them from failing when tightening.

When bolt and nut combination fasteners are used, torque values should be applied to the NUT instead of the bolt head.









Tighten toothed or serrated-type lock nuts to the full torque value.

a "Lubricated" means coated with a lubricant such as engine oil, or fasteners with phosphate and oil coatings. "Dry" means plain or zinc plated (yellow dichromate - Specification JDS117) without any lubrication.

Reference: JDS - G200.

SPECIFICATIONS & INFORMATION FASTENER TORQUES

Inch Fastener Torque Values

SAE Grade and Head Markings	1 or 2 ^b No Marks 	5 5.1 5.2 	8 8.2 
SAE Grade and Nut Markings	2 No Marks 	5  	8  

MIF

SIZE	Grade 1		Grade 2b				Grade 5, 5.1 or 5.2				Grade 8 or 8.2					
	Lubricated a		Dry a		Lubricated a		Dry a		Lubricated a		Dry a		Lubricated a		Dry a	
	N•m	lb-ft	N•m	lb-ft	N•m	lb-ft	N•m	lb-ft	N•m	lb-ft	N•m	lb-ft	N•m	lb-ft	N•m	lb-ft
1/4	3.7	2.8	4.7	3.5	6	4.5	7.5	5.5	9.5	7	12	9	13.5	10	17	12.5
5/16	7.7	5.5	10	7	12	9	15	11	20	15	25	18	28	21	35	26
3/8	14	10	17	13	22	16	27	20	35	26	44	33	50	36	63	46
7/16	22	16	28	20	35	26	44	32	55	41	70	52	80	58	100	75
1/2	33	25	42	31	53	39	67	50	85	63	110	80	120	90	150	115
9/16	48	36	60	45	75	56	95	70	125	90	155	115	175	130	225	160
5/8	67	50	85	62	105	78	135	100	170	125	215	160	215	160	300	225
3/4	120	87	150	110	190	140	240	175	300	225	375	280	425	310	550	400
7/8	190	140	240	175	190	140	240	175	490	360	625	450	700	500	875	650
1	290	210	360	270	290	210	360	270	725	540	925	675	1050	750	1300	975
1-1/8	470	300	510	375	470	300	510	375	900	675	1150	850	1450	1075	1850	1350
1-1/4	570	425	725	530	570	425	725	530	1300	950	1650	1200	2050	1500	2600	1950
1-3/8	750	550	950	700	750	550	950	700	1700	1250	2150	1550	2700	2000	3400	2550
1-1/2	1000	725	1250	925	990	725	1250	930	2250	1650	2850	2100	3600	2650	4550	3350

DO NOT use these hand torque values if a different torque value or tightening procedure is given for a specific application. Torque values listed are for general use only and include a ±10% variance factor. Check tightness of fasteners periodically. DO NOT use air powered wrenches.

Shear bolts are designed to fail under predetermined loads. Always replace shear bolts with identical grade.

Fasteners should be replaced with the same grade. Make sure fastener threads are clean and that you properly start thread engagement. This will prevent them from failing when tightening.

When bolt and nut combination fasteners are used, torque values should be applied to the NUT instead of the bolt

head.

Tighten toothed or serrated-type lock nuts to the full torque value.

a "Lubricated" means coated with a lubricant such as engine oil, or fasteners with phosphate and oil coatings. "Dry" means plain or zinc plated (yellow dichromate - Specification JDS117) without any lubrication.

b "Grade 2" applies for hex cap screws (Not Hex Bolts) up to 152 mm (6 in.) long. "Grade 1" applies for hex cap screws over 152 mm (6 in.) long, and for all other types of bolts and screws of any length.

Reference: JDS - G200

SPECIFICATIONS & INFORMATION O-RING SEAL SERVICE

O-Ring Seal Service

Face Seal Fittings With Inch Stud Ends Torque

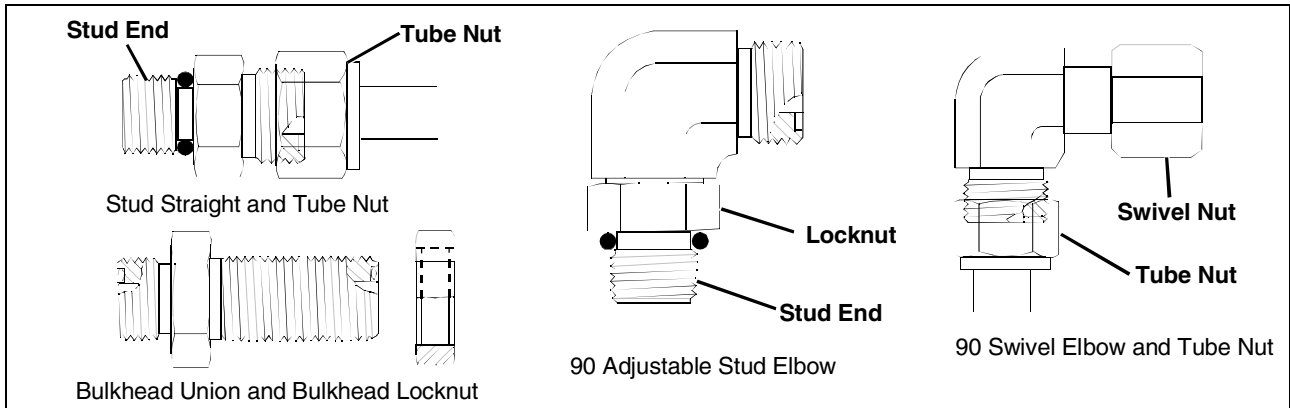

MIF

Nominal Tube OD/Hose ID				Face Seal Tube/Hose End					O-Ring Stud Ends		
Metric Tube OD	Inch Tube OD			Thread Size	Tube Nut/ Swivel Nut Torque		Bulkhead Lock Nut Torque		Thread Size	Straight Fitting or Lock Nut Torque	
	mm	Dash Size	in.		mm	in.	N•m	lb-ft		N•m	lb-ft
5	-3	0.188	4.76						3/8-24	8	6
6	-4	0.250	6.35	9/16-18	16	12	12	9	7/16-20	12	9
8	-5	0.312	7.94						1/2-20	16	12
10	-6	0.375	9.52	11/16-16	24	18	24	18	9/16-18	24	18
12	-8	0.500	12.70	13/16-16	50	37	46	34	3/4-16	46	34
16	-10	0.625	15.88	1-14	69	51	62	46	7/8-14	62	46
19	-12	0.750	19.05	1-3/16-12	102	75	102	75	1-1/16-12	102	75
22	-14	0.875	22.22	1-3/16-12	102	75	102	75	1-3/16-12	122	90
25	-16	1.000	25.40	1-7/16-12	142	105	142	105	1-5/16-12	142	105
32	-20	1.25	31.75	1-11/16-12	190	140	190	140	1-5/8-12	190	140
38	-24	1.50	38.10	2-12	217	160	217	160	1-7/8-12	217	160

NOTE: Torque tolerance is +15%, -20%

SPECIFICATIONS & INFORMATION O-RING SEAL SERVICE

Face Seal Fittings With Metric Stud Ends Torque

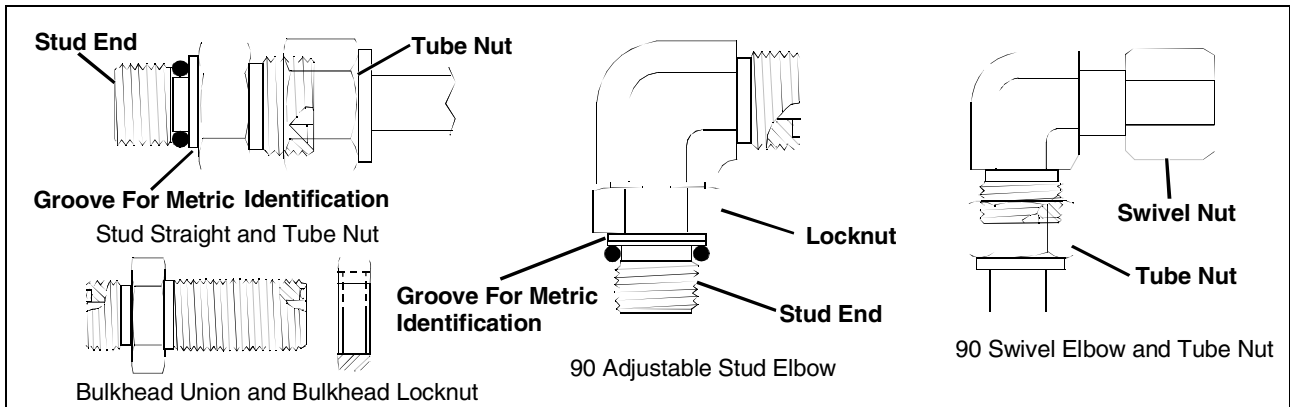

MIF

Nominal Tube OD/Hose ID				Face Seal Tube/Hose End						O-Ring Stud Ends, Straight Fitting or Lock Nut					
Metric Tube OD	Inch Tube OD			Thread Size	Hex Size	Tube Nut/ Swivel Nut Torque		Bulkhead Lock Nut Torque		Thread Size	Hex Size	Steel or Gray Iron Torque		Aluminum Torque	
	mm	Dash Size	in.			mm	in.	mm	in.			N•m	lb-ft	N•m	lb-ft
6	-4	0.250	6.35	9/16-18	17	16	12	12	9	M12X1.5	17	21	15.5	9	6.6
8	-5	0.312	7.94												
										M14X1.5	19	33	24	15	11
10	-6	0.375	9.52	11/16-16	22	24	18	24	18	M16X1.5	22	41	30	18	13
12	-8	0.500	12.70	13/16-16	24	50	37	46	34	M18X1.5	24	50	37	21	15
16	-10	0.625	15.88	1-14	30	69	51	62	46	M22X1.5	27	69	51	28	21
	-12	0.750	19.05	1-3/16-12	36	102	75	102	75	M27X2	32	102	75	46	34
22	-14	0.875	22.22	1-3/16-12	36	102	75	102	75	M30X2	36				
25	-16	1.000	25.40	1-7/16-12	41	142	105	142	105	M33X2	41	158	116	71	52
28										M38X2	46	176	130	79	58
32	-20	1.25	31.75	1-11/16-12	50	190	140	190	140	M42X2	50	190	140	85	63
38	-24	1.50	38.10	2-12	60	217	160	217	160	M48X2	55	217	160	98	72

NOTE: Torque tolerance is +15%, -20%

SPECIFICATIONS & INFORMATION O-RING SEAL SERVICE

O-ring Face Seal Fittings

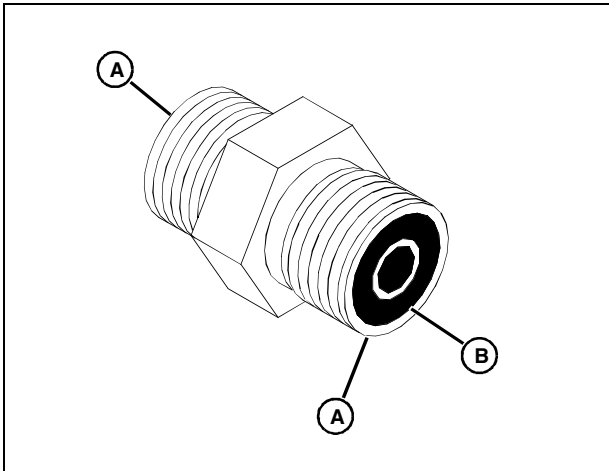

MIF

1. Inspect the fitting sealing surfaces (A). They must be free of dirt or defects.
2. Inspect the O-ring (B). It must be free of damage or defects.
3. Lubricate O-rings and install into groove using petroleum jelly to hold in place during assembly.
4. Index angle fittings and tighten by hand pressing joint together to insure O-ring remains in place.

IMPORTANT: Avoid damage! DO NOT allow hoses to twist when tightening fittings. Use two wrenches to tighten hose connections; one to hold the hose, and the other to tighten the swivel fitting.

5. Tighten fitting or nut to torque value shown on the chart per dash size stamped on the fitting.

O-Ring Boss Fittings

1. Inspect boss O-ring boss seat. It must be free of dirt and defects. If repeated leaks occur, inspect for defects with a magnifying glass. Some raised defects can be removed with a slip stone.

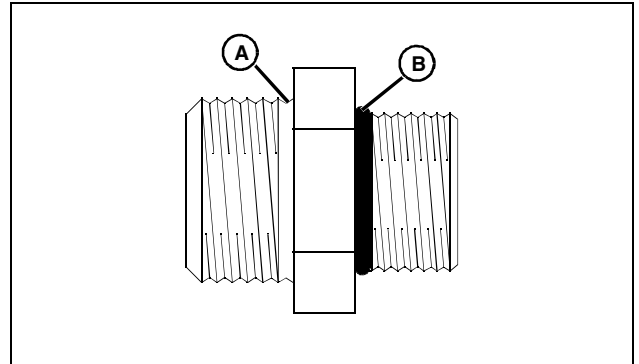

MIF

2. Put hydraulic oil or petroleum jelly on the O-ring (B). Place electrical tape over the threads to protect O-ring from nicks. Slide O-ring over the tape and into the groove (A) of fitting. Remove tape.

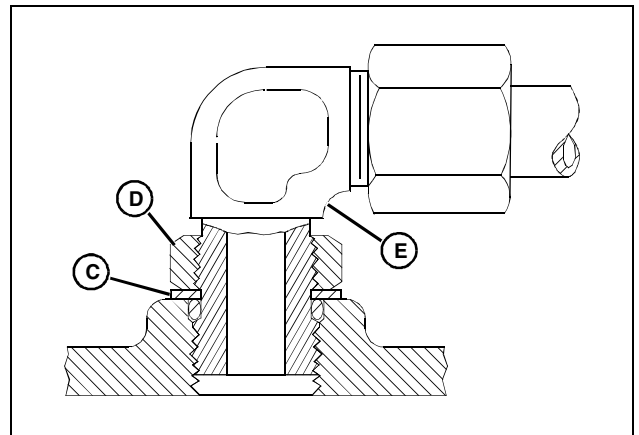

MIF

3. For angle fittings, loosen special nut (D) and push special washer (C) against threads so O-ring can be installed into the groove of fitting.
4. Turn fitting into the boss by hand until special washer or washer face (straight fitting) contacts boss face and O-ring is squeezed into its seat.
5. To position angle fittings (E), turn the fitting counter-clockwise a maximum of one turn.
6. Tighten straight fittings to torque value shown on chart. For angle fittings, tighten the special nut to value shown in the chart while holding body of fitting with a wrench.

SPECIFICATIONS & INFORMATION GENERAL INFORMATION

Straight Fitting or Special Nut Torques

Thread Size	Torque ^a		Number of Flats ^b
	N•m	lb-ft	
3/8-24 UNF	8	6	2
7/16-20 UNF	12	9	2
1/2-20 UNF	16	12	2
9/16-18 UNF	24	18	2
3/4-16 UNF	46	34	2
7/8-14 UNF	62	46	1-1/2
1-1/16-12 UN	102	75	1
1-3/16-12 UN	122	90	1
1-5/16-12 UN	142	105	3/4
1-5/8-12 UN	190	140	3/4
1-7/8-12 UN	217	160	1/2

^aTorque tolerance is ± 10 percent.

^bTo be used if a torque wrench cannot be used. After tightening fitting by hand, put a mark on nut or boss; then tighten special nut or straight fitting the number of flats shown.

Metric Fastener Torque Value - Grade 7 (Special)

Size	Steel or Gray Iron Torque	Aluminum Torque
	N•m (lb-ft)	N•m (lb-ft)
M6	11 (8)	8 (6)
M8	24 (18)	19 (14)
M10	52 (38)	41 (30)
M12	88 (65)	70 (52)
M14	138 (102)	111 (82)
M16	224 (165)	179 (132)

General Information

Gasoline

4 - Cycle Engines



CAUTION: Avoid Injury! Gasoline is HIGHLY FLAMMABLE, handle it with care. DO NOT refuel machine while: indoors, always fill gas tank outdoors; machine is near an open flame or sparks; engine is running, STOP engine; engine is hot, allow it to cool sufficiently first; smoking.

Help prevent fires: fill gas tank to bottom of filler neck only; be sure fill cap is tight after fueling; clean up any gas spills IMMEDIATELY; keep machine clean and in good repair - free of excess grease, oil, debris, and faulty or damaged parts; any storage of machines with gas left in tank should be in an area that is well ventilated to prevent possible igniting of fumes by an open flame or spark, this includes any appliance with a pilot light. To prevent fire or explosion caused by STATIC ELECTRIC DISCHARGE during fueling: •ONLY use a clean, approved POLYETHYLENE PLASTIC fuel container and funnel WITHOUT any metal screen or filter.

To avoid engine damage:

- DO NOT mix oil with gasoline;
- **ONLY use clean, fresh unleaded gasoline with an octane rating (anti-knock index) of 87 or higher;**
- fill gas tank at the end of each day's operation to help prevent condensation from forming inside a partially filled tank;
- keep up with specified service intervals.

Use of alternative oxygenated, gasohol blended, unleaded gasoline is acceptable as long as:

- the ethyl or grain alcohol blends DO NOT exceed 10% by volume or
- methyl tertiary butyl ether (MTBE) blends DO NOT exceed 15% by volume

RFG (reformulated) gasoline is acceptable for all machines designed for use of regular unleaded fuel. Older machines (that were designed for leaded fuel) may see some accelerated valve and seat wear.

SPECIFICATIONS & INFORMATION GENERAL INFORMATION

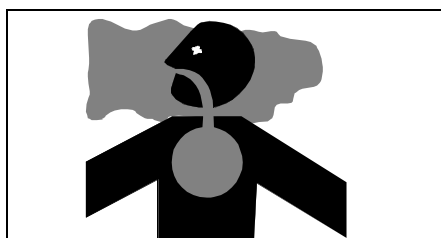

MIF

IMPORTANT: Avoid damage! California Proposition 65 Warning: Gasoline engine exhaust from this product contains chemicals known to the State of California to cause cancer, birth defects, or other reproductive harm.

Gasoline Storage

IMPORTANT: Avoid damage! Keep all dirt, scale, water or other foreign material out of gasoline.

Keep gasoline stored in a safe, protected area. Storage of gasoline in a clean, properly marked ("UNLEADED GASOLINE") POLYETHYLENE PLASTIC container WITHOUT any metal screen or filter is recommended. DO NOT use de-icers to attempt to remove water from gasoline or depend on fuel filters to remove water from gasoline. Use a water separator installed in the storage tank outlet. BE SURE to properly discard unstable or contaminated gasoline. When storing the machine or gasoline, it is recommended that you add **John Deere Gasoline Conditioner and Stabilizer (TY15977)** or an equivalent to the gasoline. BE SURE to follow directions on container and to properly discard empty container.

4 - Cycle Gasoline Engine Oil

Use the appropriate oil viscosity based on the expected air temperature range during the period between recommended oil changes. Operating outside of these recommended oil air temperature ranges may cause premature engine failure.

The following John Deere oils are **PREFERRED**:

- **PLUS - 4@ - SAE 10W-40;**
- **TORQ - GARD SUPREME® - SAE 5W-30.**

The following John Deere oils are **also recommended**, based on their specified temperature range:

- **TURF - GARD® - SAE 10W-30;**
- **PLUS - 4@ - SAE 10W-30;**
- **TORQ - GARD SUPREME® - SAE 30.**

Other oils may be used if above John Deere oils are not available, provided they meet one of the following specifications:

- SAE 10W-40 - API Service Classifications SG or higher;
- SAE 5W-30 - API Service Classification SG or higher;
- SAE 10W-30 - API Service Classifications SG or higher;
- SAE 30 - API Service Classification SC or higher.

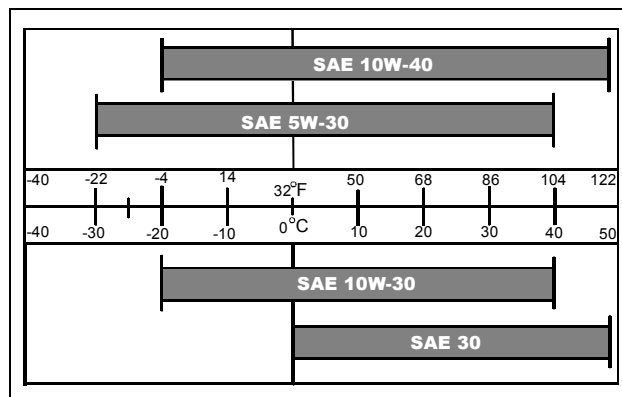

Break-In Engine Oil - 4-Cycle Gasoline

IMPORTANT: Avoid damage! ONLY use a quality break-in oil in rebuilt or remanufactured engines for the first 5 hours (maximum) of operation. DO NOT use oils with heavier viscosity weights than SAE 5W-30 or oils meeting specifications API SG or SH, these oils will not allow rebuilt or remanufactured engines to break-in properly.

The following John Deere oil is **PREFERRED**:

- **BREAK - IN ENGINE OIL.**

John Deere BREAK - IN ENGINE OIL is formulated with special additives for aluminum and cast iron type engines to allow the power cylinder components (pistons, rings, and liners as well) to "wear-in" while protecting other engine components, valve train and gears, from abnormal wear. Engine rebuild instructions should be followed closely to determine if special requirements are necessary.

John Deere BREAK - IN ENGINE OIL is also recommended for non-John Deere engines, both aluminum and cast iron types.

The following John Deere oil is **also recommended**:

- **TORQ - GARD SUPREME® - SAE 5W-30.**

If the above recommended John Deere oils are not available, use a break-in engine oil meeting the following specification during the first **5 hours (maximum)** of operation:

- SAE 5W-30 - API Service Classification SE or higher.

SPECIFICATIONS & INFORMATION GENERAL INFORMATION

IMPORTANT: Avoid damage! After the break-in period, use the John Deere oil that is recommended for this engine.

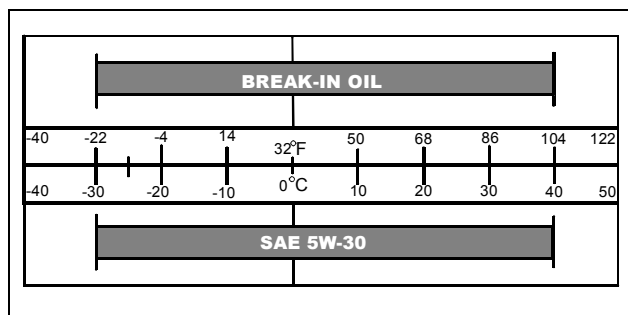

Hydrostatic Transmission and Hydraulic Oil

Use the appropriate oil viscosity based on these air temperature ranges. Operating outside of these recommended oil air temperature ranges may cause premature hydrostatic transmission or hydraulic system failures.

IMPORTANT: Avoid damage! Use only the oils recommended. HY-GARD® - JDM J20C can be mixed with 5W30 or 10W30 in this application.

Do not use LOW VISCOSITY HY - GARD® oil.

The following John Deere transmission and hydraulic oil is **PREFERRED**:

- **HY-GARD® - JDM J20C.**

The following John Deere oil is also recommended if above preferred oil is not available:

- **5W30 or 10W30.**

Other oils may be used if above recommended John Deere oils are not available, provided they meet one of the following specifications:

- John Deere Standard JDM J20C.

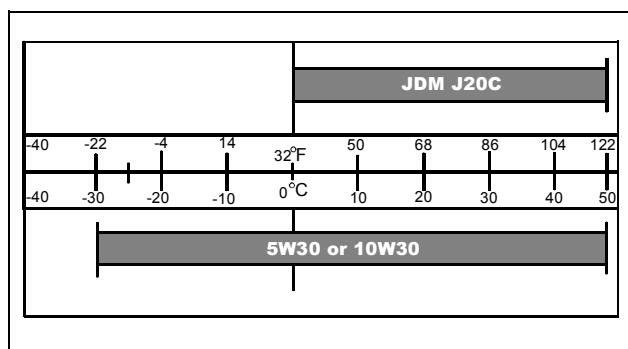

Oil Filters

IMPORTANT: Avoid damage! Filtration of oils is critical to proper lubrication performance. Always change filters regularly.

The following John Deere oil filters are **PREFERRED**:

- **AUTOMOTIVE AND LIGHT TRUCK ENGINE OIL FILTERS.**

Most John Deere filters contain pressure relief and anti-drainback valves for better engine protection.

Other oil filters may be used if above recommended John Deere oil filters are not available, provided they meet the following specification:

- **ASTB Tested In Accordance With SAE J806.**

Alternative Lubricants

Use of alternative lubricants could cause reduced life of the component.

If alternative lubricants are to be used, it is recommended that the factory fill be thoroughly removed before switching to any alternative lubricant.

Synthetic Lubricants

Synthetic lubricants may be used in John Deere equipment if they meet the applicable performance requirements (industry classification and/or military specification) as shown in this manual.

The recommended air temperature limits and service or lubricant change intervals should be maintained as shown in the operator's manual, unless otherwise stated on lubricant label.

Avoid mixing different brands, grades, or types of oil. Oil manufacturers blend additives in their oils to meet certain specifications and performance requirements. Mixing different oils can interfere with the proper functioning of these additives and degrade lubricant performance.

Lubricant Storage

All machines operate at top efficiency only when clean lubricants are used. Use clean storage containers to handle all lubricants. Store them in an area protected from dust, moisture, and other contamination. Store drums on their sides. Make sure all containers are properly marked as to their contents. Dispose of all old, used containers and their contents properly.

SPECIFICATIONS & INFORMATION COOLANT SPECIFICATIONS

Mixing of Lubricants

In general, avoid mixing different brands or types of lubricants. Manufacturers blend additives in their lubricants to meet certain specifications and performance requirements. Mixing different lubricants can interfere with the proper functioning of these additives and lubricant properties which will downgrade their intended specified performance.

Coolant Specifications

Gasoline Engine Coolant

The engine cooling system when filled with a proper dilution mixture of anti-freeze and deionized or distilled water provides year-round protection against corrosion, cylinder or liner pitting, and winter freeze protection down to **-37°C (-34°F)**.

The following John Deere coolant is **PREFERRED**:

- **COOL-GARD® PRE-DILUTED SUMMER COOLANT (TY16036)**.

This coolant satisfies specifications for "Automobile and Light Duty Engine Service" and is safe for use in John Deere Lawn and Grounds Care/Golf and Turf Division equipment, including aluminum block gasoline engines and cooling systems.

The above preferred pre-diluted anti-freeze provides:

- adequate heat transfer
- corrosion-resistant chemicals for the cooling system
- compatibility with cooling system hose and seal material
- protection during extreme cold and extreme hot weather operations
- chemically pure water for better service life
- compliance with ASTM D4656 (JDM H24C2) specifications

If above preferred pre-diluted coolant is not available, the following John Deere concentrate is recommended:

- **COOL-GARD® CONCENTRATED SUMMER COOLANT CONCENTRATE™ (TY16034)**.

If either of above recommended engine coolants are available use any Automobile and Light Duty Engine Service ethylene glycol base coolant, meeting the following specification:

- ASTM D4985 (JDM H24A2).

Read container label completely before using and follow instructions as stated.

IMPORTANT: Avoid damage! To prevent engine damage, DO NOT use pure anti-freeze or less than a 50% anti-freeze mixture in the cooling system. DO NOT mix or add any additives/conditioners to the cooling system in Lawn and Grounds Care/Golf and Turf Division equipment. Water used to dilute engine coolant concentrate must be of high quality - clean, clear, potable water (low in chloride and hardness - Table 1) is generally acceptable. DO NOT use salt water. Deionized or distilled water is ideal to use. Coolant that is not mixed to these specified levels and water purity can cause excessive scale, sludge deposits, and increased corrosion potential.

Property	Requirements
Total Solids, Maximum	340 ppm (20 grns/gal)
Total Hardness, Maximum	170 ppm (10 grns/gal)
Chloride (as Cl), Maximum	40 ppm (2.5 grns/gal)
Sulfate (as SO ₄), Maximum	100 ppm (5.8 grns/gal)

Mix 50 percent anti-freeze concentrate with 50 percent distilled or deionized water. This mixture and the pre-diluted mixture (TY16036) will protect the cooling system down to **-37°C (-34°F)** and up to **108°C (226°F)**.

Certain geographical areas may require lower air temperature protection. See the label on your anti-freeze container or consult your John Deere dealer to obtain the latest information and recommendations.

Gasoline Engine Coolant Drain Interval

When using John Deere Pre-Diluted (TY16036) Automobile and Light Duty Engine Service coolants, drain and flush the cooling system and refill with fresh coolant mixture every 36 months or 3,000 hours of operation, whichever comes first.

When using John Deere Concentrate (TY16034) Automobile and Light Duty Engine Service coolants, drain and flush the cooling system and refill with fresh coolant mixture every 24 months or 2,000 hours of operation, whichever comes first.

If above John Deere Automobile and Light Duty Engine Service coolants are not being used; drain, flush, and refill the cooling system according to instructions found on product container or in equipment operator's manual or technical manual.

SPECIFICATIONS & INFORMATION SERIAL NUMBER LOCATIONS

Serial Number Locations

Product Serial Number

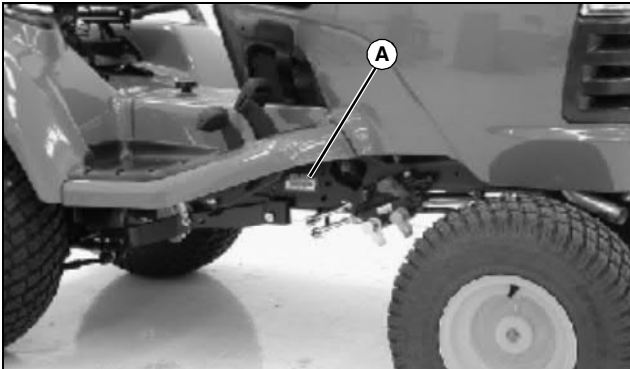

M55444

The 13-digit product identification number (A) is located on the right-hand side frame, just below engine compartment.

Gasoline Engine Serial Number Location

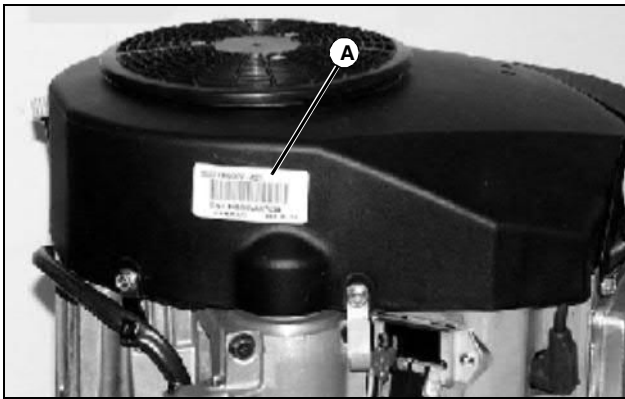

M95470

LX280

Engine serial number (A) is located above the starting motor.

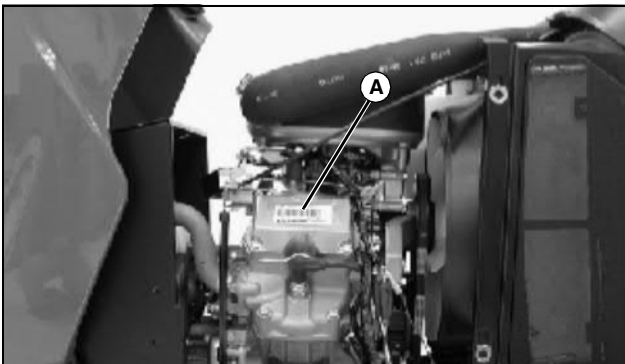

MX13637

LX289

Engine serial number (A) is located on the valve cover.

ENGINE - KAWASAKI (LIQUID-COOLED) TABLE OF CONTENTS

Table of Contents	
Specifications	21
General Specifications	21
Test and Adjustment Specifications	21
Repair Specifications.....	22
Torque Specifications (Alphabetical).....	24
Tools and Materials	25
Special or Essential Tools	25
Service Parts Kits	26
Component Location	27
Exterior Engine Components	27
Internal Engine Components.....	29
Theory of Operation	31
Lubrication System Operation	31
Cooling System Operation	33
Diagnostics	35
Engine Diagnosis	35
Engine Tests	38
Tests and Adjustments	41
Throttle Cable Test and Adjustment.....	41
Choke Cable Adjustment.....	41
Governor Static Adjustment	42
Fast Idle Speed Adjustment	42
Slow Idle Speed Adjustment	43
Cylinder Compression Pressure Test.....	43
Valve Clearance Test and Adjustment	44
Crankcase Vacuum Test	45
Engine Oil Pressure Test	45
Fuel Pump Tests	46
Spark Test.....	47
Spark Plug Gap Adjustment	47
Cooling System Pressure Test.....	48
Radiator Cap Pressure Test.....	48
Repair	49
Throttle Control Lever and Cable Assembly	49
Muffler Removal and Installation	49
Engine Removal and Installation.....	50
Air Cleaner	52
Carburetor Removal and Installation.....	52
Intake Manifold	56
Fuel Pump.....	56
Radiator Removal and Installation	57
Cooling Fan.....	58
Cooling Air Duct	58
Thermostat.....	59
Coolant Pump	59
Overflow Reservoir	61
Flywheel Removal and Installation	61
Rocker Arm Assembly	61
Cylinder Head and Valves	62
Recondition Valve Seats.....	64
Lap Valves	65
Crankcase Cover	65
Piston and Connecting Rod.....	66
Camshaft and Tappets	69
Crankshaft and Main Bearings	70
Crankshaft Oil Seals.....	71
Cylinder Block.....	72
Deglaze Cylinder Bore.....	72
Rebore Cylinder Block.....	72
Oil Pump.....	73
Breather.....	75
Governor.....	75
Governor Shaft	76
Governor Shaft Seal	76
Stator Removal and Installation.....	76
Pulser Coils.....	76
Ignition Coils	77
Ignition Module Replacement	77
Starting Motor	77
No-Load Amperage Draw and RPM Test....	79

ENGINE - KAWASAKI (LIQUID-COOLED) SPECIFICATIONS

Specifications

General Specifications

Engine Use	LX289
Make	Kawasaki V-Twin
Model Number	FD501V-DS04
Horsepower	12.7 kW (17 hp)
Bore	67 mm (2.64 in.)
Stroke	71.19 mm (2.80 in.)
Displacement	501 cm ³ (30.6 cu in.)
Cylinders	2 (V-twin)
Stroke/Cycle	4
Valves	Overhead Valves
Lubrication	Fully Pressurized
Crankcase Oil Capacity without Oil Filter	1.5 L (1.6 qt)
with Oil Filter	1.8 L (1.9 qt)
Oil Filter	Single Element, Full Flow, Spin-On Filter
Cooling System	Liquid Cooled
Cooling System Capacity	2.6 L (2.8 qt)
Air Cleaner	Dry Replaceable with Foam Pre-cleaner
Muffler	Horizontal Discharge Below Frame
Spark Plug Gap	0.7 mm (0.028 in.)
Spark Plug Torque	20 N•m (15 lb-ft)

Test and Adjustment Specifications

Slow Idle	1550 ± 150 rpm
Fast Idle	3550 ± 50 rpm
Choke Arm Gap	0.25 - 3.0 mm (0.01 - 0.12 in.)
Ignition Air Gap	fixed position no adjustment
Cylinders:	
Compression Pressure (Minimum)	1171 kPa (170 psi)
Difference Between Cylinders (Maximum)	97 kPa (14 psi)
Valve Clearance (Cold)	0.15 mm (0.006 in.)
Crankcase Vacuum	1.27 - 38.1 cm (0.5 - 15.0 in.)
Engine Oil Pressure at Fast Idle (Minimum)	276 kPa (40 psi)
Engine Oil Pressure at Fast Idle (Maximum) - Relief Valve Pressure	296 kPa (43 psi)
Fuel Pump:	
Pressure at Slow Idle (Minimum)	2.45 kPa (0.36 psi)
Flow Volume at Slow Idle (Minimum)	800 mL/60 seconds (0.8 qt/60 seconds)
Fuel Pump Push Rod Bend (Maximum)	0.05 mm (0.002 in.)



Suggest:

If the above button click is invalid.

Please download this document

first, and then click the above link

to download the complete manual.

Thank you so much for reading

ENGINE - KAWASAKI (LIQUID-COOLED) SPECIFICATIONS

Cooling System:

Operating Pressure

Minimum 90 kPa (13 psi)

Maximum 117 kPa (17 psi)

Radiator Cap Relief Pressure 73 - 103 kPa (10.6 - 14.9 psi)

Vacuum Valve 4.9 kPa (0.71 psi)

Coolant Temperature Switch Continuity (On) 107 - 113° C (225 - 235° F)

Capacity 2.10 L (2.2 US qt)

Repair Specifications

Cooling System:

Thermostat

Begin Opening 63 - 66° C (145 - 150° F)

Fully Open 80° C (176° F)

Impeller Shaft OD (Minimum) 9.935 mm (0.3911 in.)

Shaft Bore ID (Maximum) 10.09 mm (0.397 in.)

Rocker Arm Assembly:

Shaft OD (Minimum) 11.95 mm (0.470 in.)

Bearing ID (Maximum) 12.07 mm (0.475 in.)

Maximum Push Rod Bend 0.80 mm (0.031 in.)

Breather Reed Valve Tip Air Gap 0.2 mm (0.008 in.)

Cylinder Head:

Cylinder Head Distortion (Maximum) 0.06 mm (0.002 in.)

Valve Guide ID (Maximum) 5.06 mm (0.199 in.)

Valve Seat Width 0.5 - 1.1 mm (0.02 - 0.043 in.)

Valve Spring Free Length (Minimum) 27.30 mm (1.074 in.)

Intake and Exhaust Valves:

Valve Stem OD (Minimum)

Intake 4.93 mm (0.194 in.)

Exhaust 4.92 mm (0.193 in.)

Valve Stem Bend (Maximum) 0.03 mm (0.001 in.)

Valve Seating Surface (Standard) 0.80 mm (0.031 in.)

Valve Seat and Face Angle 45°

Valve Margin (Minimum) 0.50 mm (0.020 in.)

Valve Narrow Angle 30°

Piston Assembly:

Piston Ring Side Clearance (Maximum)

Compression Ring Grooves 0.10 mm (0.004 in.)

<https://www.ebooklibonline.com>

Hello dear friend!

Thank you very much for reading.

Enter the link into your browser.

The full manual is available for immediate download.

<https://www.ebooklibonline.com>