

**JOHN DEERE**  
**WORLDWIDE COMMERCIAL & CONSUMER**  
**EQUIPMENT DIVISION**

---

**Lawn Tractors**  
**L105, L107 and L120**

**TM2185 FEBRUARY 2004**

**TECHNICAL MANUAL**



**JOHN DEERE**

Export Version  
Litho in U.S.A.

# INTRODUCTION

---

## Manual Description

This technical manual is written for an experienced technician and contains sections that are specifically for this product. It is a part of a total product support program.

The manual is organized so that all the information on a particular system is kept together. The order of grouping is as follows:

- Table of Contents
- Specifications and Information
- Identification Numbers
- Tools and Materials
- Component Location
- Schematics and Harnesses
- Theory of Operation
- Operation and Diagnostics
- Diagnostics
- Tests and Adjustments
- Repair
- Other

**NOTE: Depending on the particular section or system being covered, not all of the above groups may be used.**

The bleed tabs for the pages of each section will align with the sections listed on this page. Page numbering is consecutive from the beginning of the Safety section through the last section.

We appreciate your input on this manual. If you find any errors or want to comment on the layout of the manual please contact us.

Safety

Specifications and Information

Engine (B&S - Single Cylinder)

Engine (B&S - V-Twin)

Electrical

Power Train (Hydrostatic)

Steering

Brakes

Attachments

Miscellaneous

All information, illustrations and specifications in this manual are based on the latest information at the time of publication. The right is reserved to make changes at any time without notice.

COPYRIGHT© 2004  
Deere & Co.  
John Deere Worldwide Commercial and  
Consumer Equipment Division  
All rights reserved  
Previous Editions  
COPYRIGHT©

# SAFETY

## Recognize Safety Information

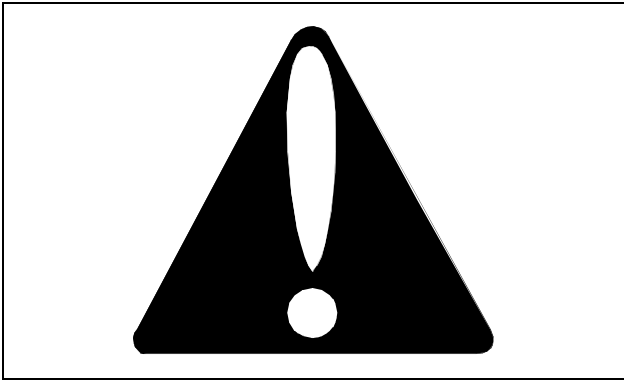

MIF

This is the safety-alert symbol. When you see this symbol on your machine or in this manual, be alert to the potential for personal injury.

Follow recommended precautions and safe servicing practices.

## Understand Signal Words

A signal word - DANGER, WARNING, or CAUTION - is used with the safety-alert symbol. DANGER identifies the most serious hazards.

DANGER or WARNING safety signs are located near specific hazards. General precautions are listed on CAUTION safety signs. CAUTION also calls attention to safety messages in this manual.

## Replace Safety Signs

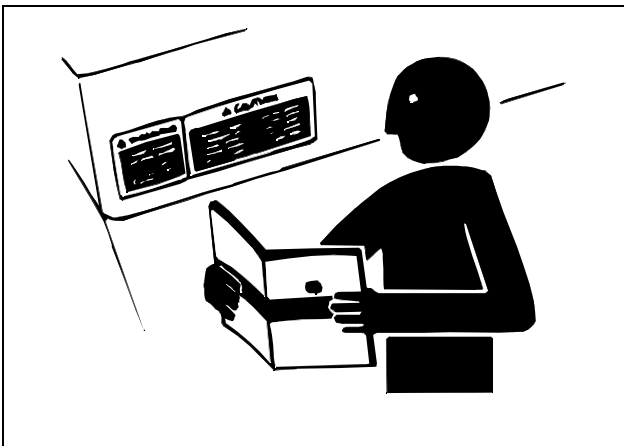

MIF

Replace missing or damaged safety signs. See the machine operator's manual for correct safety sign placement.

## Handle Fluids Safely - Avoid Fires

### Be Prepared For Emergencies

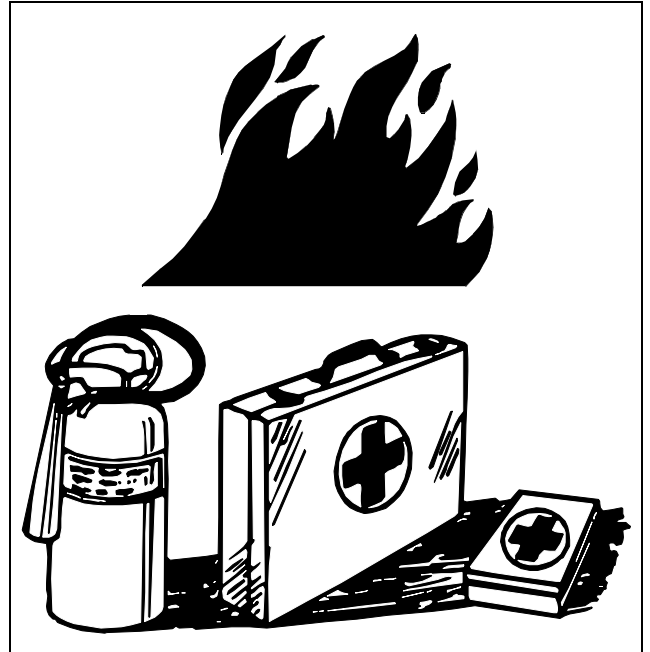

MIF

- When you work around fuel, do not smoke or work near heaters or other fire hazards.
- Store flammable fluids away from fire hazards. Do not incinerate or puncture pressurized containers.
- Make sure machine is clean of trash, grease, and debris.
- Do not store oily rags; they can ignite and burn spontaneously.
- Be prepared if a fire starts.
- Keep a first aid kit and fire extinguisher handy.
- Keep emergency numbers for doctors, ambulance service, hospital, and fire department near your telephone.

## Use Care In Handling and Servicing Batteries

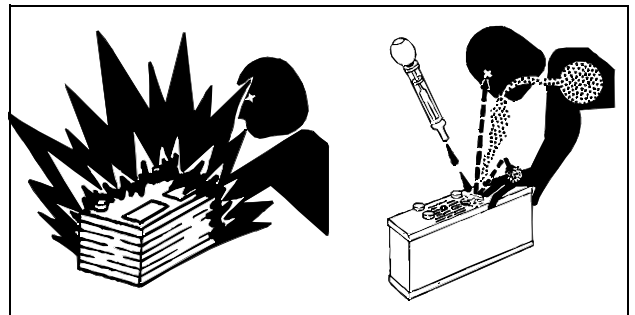

MIF

**<https://www.ebooklibonline.com>**

Hello dear friend!

Thank you very much for reading.

Enter the link into your browser.

The full manual is available for immediate download.

**<https://www.ebooklibonline.com>**

# SAFETY

## Prevent Battery Explosions

- Keep sparks, lighted matches, and open flame away from the top of battery. Battery gas can explode.
- Never check battery charge by placing a metal object across the posts. Use a volt-meter or hydrometer.
- Do not charge a frozen battery; it may explode. Warm battery to 16°C (60°F).

## Prevent Acid Burns

- Sulfuric acid in battery electrolyte is poisonous. It is strong enough to burn skin, eat holes in clothing, and cause blindness if splashed into eyes.

### Avoid acid burns by:

1. Filling batteries in a well-ventilated area.
2. Wearing eye protection and rubber gloves.
3. Avoiding breathing fumes when electrolyte is added.
4. Avoiding spilling or dripping electrolyte.
5. Use proper jump start procedure.

### If you spill acid on yourself:

1. Flush your skin with water.
2. Apply baking soda or lime to help neutralize the acid.
3. Flush your eyes with water for 10 - 15 minutes.
4. Get medical attention immediately.

### If acid is swallowed:

1. Drink large amounts of water or milk.
2. Then drink milk of magnesia, beaten eggs, or vegetable oil.
3. Get medical attention immediately.

## Wear Protective Clothing

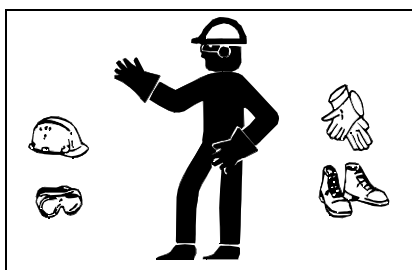

MIF

Wear close fitting clothing and safety equipment appropriate to the job.

Prolonged exposure to loud noise can cause impairment or loss of hearing. Wear a suitable hearing protective device

such as earmuffs or earplugs to protect against objectionable or uncomfortable loud noises.

Operating equipment safely requires the full attention of the operator. Do not wear radio or music headphones while operating machine.

## Use Care Around High-pressure Fluid Lines

### Avoid High-Pressure Fluids



MIF

Escaping fluid under pressure can penetrate the skin causing serious injury.

Avoid injury from escaping fluid under pressure by stopping the engine and relieving pressure in the system before disconnecting or connecting hydraulic or other lines. Tighten all connections before applying pressure.

Search for leaks with a piece of cardboard. Protect hands and body from high pressure fluids.

If an accident occurs, see a doctor immediately. Any fluid injected into the skin must be surgically removed within a few hours or gangrene may result. Doctors unfamiliar with this type of injury should reference a knowledgeable medical source. Such information is available from Deere & Company Medical Department in Moline, Illinois, U.S.A.

### Avoid Heating Near Pressurized Fluid Lines



MIF

Flammable spray can be generated by heating near pressurized fluid lines, resulting in severe burns to yourself and bystanders. Do not heat by welding, soldering, or using a torch near pressurized fluid lines or other flammable materials. Pressurized lines can be accidentally cut when heat goes beyond the immediate flame area.

# SAFETY

## Parking Safely

1. Stop machine on a level surface, not on a slope.
2. Disengage PTO and stop attachments.
3. Lower attachments to the ground.
4. Lock park brake.
5. Stop engine.
6. Remove key.
7. Wait for engine and all moving parts to stop before you leave the operator's station.
8. Close fuel shut-off valve, if your machine is equipped.

## Service Machines Safely

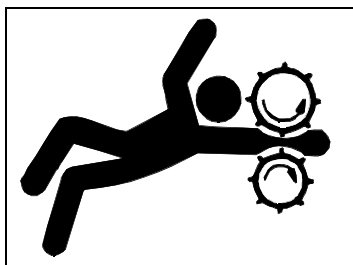

MIF

Tie long hair behind your head. Do not wear a necktie, scarf, loose clothing, or necklace when you work near machine tools or moving parts. If these items were to get caught, severe injury could result.

Remove rings and other jewelry to prevent electrical shorts and entanglement in moving parts.

## Use Proper Tools

Use tools appropriate to the work. Makeshift tools and procedures can create safety hazards. Use power tools only to loosen threaded parts and fasteners. For loosening and tightening hardware, use the correct size tools. **DO NOT** use U.S. measurement tools on metric fasteners. Avoid bodily injury caused by slipping wrenches. Use only service parts meeting John Deere specifications.

## Work in Clean Area

### Before starting a job:

1. Clean work area and machine.
2. Make sure you have all necessary tools to do your job.
3. Have the right parts on hand.
4. Read all instructions thoroughly; do not attempt shortcuts.

## Support Machine Properly and Use Proper Lifting Equipment

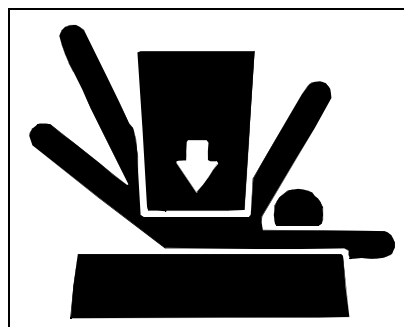

MIF

If you must work on a lifted machine or attachment, securely support the machine or attachment.

Do not support the machine on cinder blocks, hollow tiles, or props that may crumble under continuous load. Do not work under a machine that is supported solely by a jack. Follow recommended procedures in this manual.

Lifting heavy components incorrectly can cause severe injury or machine damage. Follow recommended procedure for removal and installation of components in the manual.

## Using High Pressure Washers

Directing pressurized water at electronic/electrical components or connectors, bearings, hydraulic seals, fuel injection pumps or other sensitive parts and components may cause product malfunctions. Reduce pressure and spray at a 45 to 90 degree angle.

## Illuminate Work Area Safely

Illuminate your work area adequately but safely. Use a portable safety light for working inside or under the machine. Make sure the bulb is enclosed by a wire cage. The hot filament of an accidentally broken bulb can ignite spilled fuel or oil.

# SAFETY

## Work In Ventilated Area

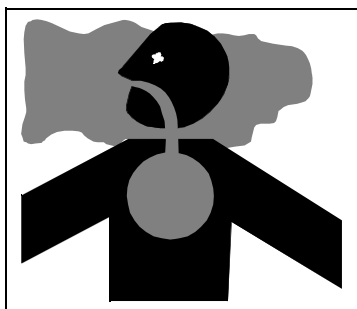

MIF

Engine exhaust fumes can cause sickness or death. If it is necessary to run an engine in an enclosed area, remove the exhaust fumes from the area with an exhaust pipe extension.

If you do not have an exhaust pipe extension, open the doors and get outside air into the area.

## Warning: California Proposition 65 Warning

Gasoline engine exhaust from this product contains chemicals known to the State of California to cause cancer, birth defects, or other reproductive harm.

Diesel engine exhaust and some of its constituents are known to the State of California to cause cancer, birth defects, and other reproductive harm.

## Remove Paint Before Welding or Heating

Avoid potentially toxic fumes and dust. Hazardous fumes can be generated when paint is heated by welding, soldering, or using a torch. Do all work outside or in a well ventilated area. Dispose of paint and solvent properly. Remove paint before welding or heating: If you sand or grind paint, avoid breathing the dust. Wear an approved respirator. If you use solvent or paint stripper, remove stripper with soap and water before welding. Remove solvent or paint stripper containers and other flammable material from area. Allow fumes to disperse at least 15 minutes before welding or heating.

## Avoid Harmful Asbestos Dust

Avoid breathing dust that may be generated when handling components containing asbestos fibers. Inhaled asbestos fibers may cause lung cancer.

Components in products that may contain asbestos fibers are brake pads, brake band and lining assemblies, clutch plates, and some gaskets. The asbestos used in these components is usually found in a resin or sealed in some way. Normal handling is not hazardous as long as airborne dust containing asbestos is not generated.

Avoid creating dust. Never use compressed air for cleaning. Avoid brushing or grinding material containing asbestos. When servicing, wear an approved respirator. A special vacuum cleaner is recommended to clean asbestos. If not available, apply a mist of oil or water on the material containing asbestos. Keep bystanders away from the area.

## Service Tires Safely

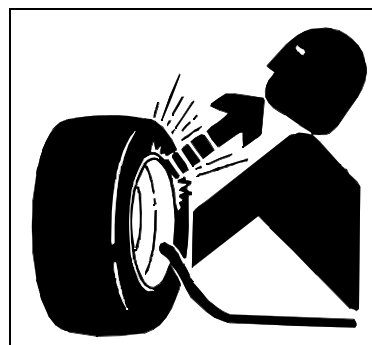

MIF

Explosive separation of a tire and rim parts can cause serious injury or death.

Do not attempt to mount a tire unless you have the proper equipment and experience to perform the job.

Always maintain the correct tire pressure. Do not inflate the tires above the recommended pressure. Never weld or heat a wheel and tire assembly. The heat can cause an increase in air pressure resulting in a tire explosion. Welding can structurally weaken or deform the wheel.

When inflating tires, use a clip-on chuck and extension hose long enough to allow you to stand to one side and NOT in front of or over the tire assembly. Use a safety cage if available.

Check wheels for low pressure, cuts, bubbles, damaged rims or missing lug bolts and nuts.

# SAFETY

## Avoid Injury From Rotating Blades, Augers and PTO Shafts

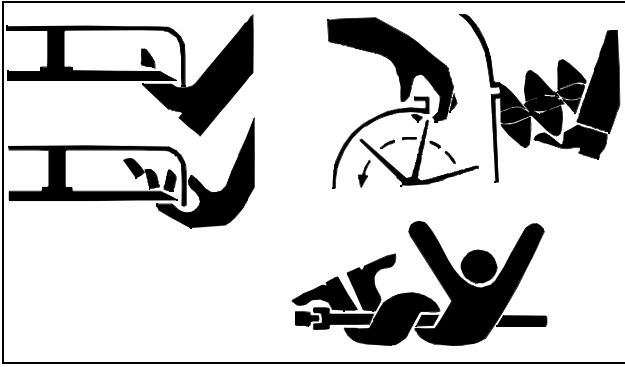

MIF

Keep hands and feet away while machine is running. Shut off power to service, lubricate or remove mower blades, augers or PTO shafts.

## Service Cooling System Safely

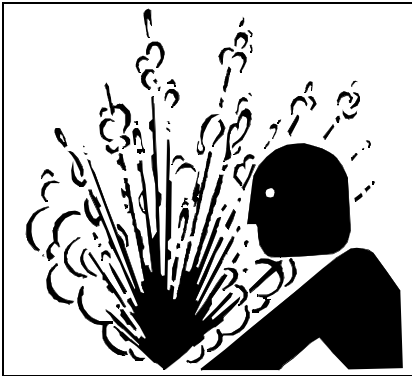

MIF

Explosive release of fluids from pressurized cooling system can cause serious burns.

Shut off machine. Only remove filler cap when cool enough to touch with bare hands. Slowly loosen cap to first stop to relieve pressure before removing completely.

## Handle Chemical Products Safely

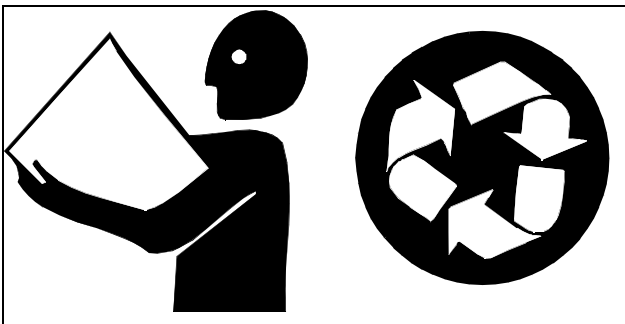

MIF

Direct exposure to hazardous chemicals can cause serious injury. Potentially hazardous chemicals used with John Deere equipment include such items as lubricants, coolants, paints, and adhesives.

A Material Safety Data Sheet (MSDS) provides specific details on chemical products: physical and health hazards, safety procedures, and emergency response techniques. Check the MSDS before you start any job using a hazardous chemical. That way you will know exactly what the risks are and how to do the job safely. Then follow procedures and recommended equipment.

## Dispose of Waste Properly

Improperly disposing of waste can threaten the environment and ecology. Potentially harmful waste used with John Deere equipment include such items as oil, fuel, coolant, brake fluid, filters, and batteries. Use leakproof containers when draining fluids. Do not use food or beverage containers that may mislead someone into drinking from them. Do not pour waste onto the ground, down a drain, or into any water source. Inquire on the proper way to recycle or dispose of waste from your local environmental or recycling center, or from your John Deere dealer.

## Live with Safety



MIF

Before returning machine to customer, make sure machine is functioning properly, especially the safety systems. Install all guards and shields.

# SPECIFICATIONS & INFORMATION TABLE OF CONTENTS

---

## Table of Contents

<b>Fastener Torques</b> .....	<b>9</b>
Metric Fastener Torque Values .....	9
Metric Fastener Torque Value - Grade 7.....	10
Inch Fastener Torque Values .....	11
<b>General Information</b> .....	<b>13</b>
Gasoline .....	13
Gasoline Storage.....	13
Engine Oil.....	14
Engine Break-in Oil .....	14
Alternative Lubricants.....	15
Synthetic Lubricants .....	15
Lubricant Storage .....	15
Mixing Of Lubricants.....	15
Chassis Grease.....	15
Hydrostatic Transmission Oil.....	16
<b>Serial Number Locations</b> .....	<b>16</b>
Machine Product Identification Number .....	16
Engine Serial Number .....	16
Transaxle Serial Number.....	16

# SPECIFICATIONS & INFORMATION FASTENER TORQUES

## Fastener Torques

### Metric Fastener Torque Values

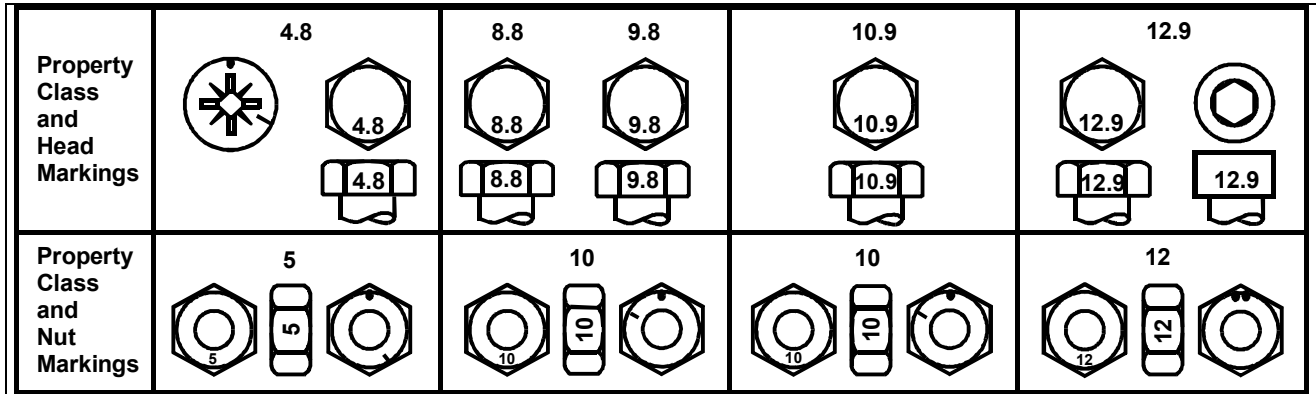

MIF

SIZE	Class 4.8				Class 8.8 or 9.8				Class 10.9				Class 12.9			
	Lubricated a		Dry a		Lubricated a		Dry a		Lubricated a		Dry a		Lubricated a		Dry a	
	N•m	lb-ft	N•m	lb-ft	N•m	lb-ft	N•m	lb-ft	N•m	lb-ft	N•m	lb-ft	N•m	lb-ft	N•m	lb-ft
M6	4.8	3.5	6	4.5	9	6.5	11	8.5	13	9.5	17	12	15	11.5	19	14.5
M8	12	8.5	15	11	22	16	28	20	32	24	40	30	37	28	47	35
M10	23	17	29	21	43	32	55	40	63	47	80	60	75	55	95	70
M12	40	29	50	37	75	55	95	70	110	80	140	105	130	95	165	120
M14	63	47	80	60	120	88	150	110	175	130	225	165	205	150	260	109
M16	100	73	125	92	190	140	240	175	275	200	350	225	320	240	400	300
M18	135	100	175	125	260	195	330	250	375	275	475	350	440	325	560	410
M20	190	140	240	180	375	275	475	350	530	400	675	500	625	460	800	580
M22	260	190	330	250	510	375	650	475	725	540	925	675	850	625	1075	800
M24	330	250	425	310	650	475	825	600	925	675	1150	850	1075	800	1350	1000
M27	490	360	625	450	950	700	1200	875	1350	1000	1700	1250	1600	1150	2000	1500
M30	675	490	850	625	1300	950	1650	1200	1850	1350	2300	1700	2150	1600	2700	2000
M33	900	675	1150	850	1750	1300	2200	1650	2500	1850	3150	2350	2900	2150	3700	2750
M36	1150	850	1450	1075	2250	1650	2850	2100	3200	2350	4050	3000	3750	2750	4750	3500

DO NOT use these hand torque values if a different torque value or tightening procedure is given for a specific application. Torque values listed are for general use only and include a  $\pm 10\%$  variance factor. Check tightness of fasteners periodically. DO NOT use air powered wrenches.

Shear bolts are designed to fail under predetermined loads. Always replace shear bolts with identical grade.

Fasteners should be replaced with the same class. Make sure fastener threads are clean and that you properly start thread engagement. This will prevent them from failing when tightening.

When bolt and nut combination fasteners are used, torque values should be applied to the NUT instead of the bolt head.

Tighten toothed or serrated-type lock nuts to the full torque value.

a "Lubricated" means coated with a lubricant such as engine oil, or fasteners with phosphate and oil coatings. "Dry" means plain or zinc plated (Yellow Dichromate - Specification JDS117) without any lubrication.

Reference: JDS - G200

# SPECIFICATIONS & INFORMATION FASTENER TORQUES







---

## Metric Fastener Torque Value - Grade 7

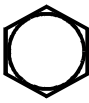
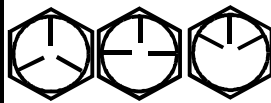
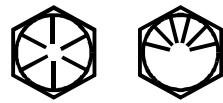
Size	Steel or Gray Iron Torque		Aluminum Torque	
	N•m	lb-ft	N•m	lb-ft
M6	11	8	8	6
M8	24	18	19	14
M10	52	38	41	30
M12	88	65	70	52
M14	138	102	111	82
M16	224	165	179	132

# SPECIFICATIONS & INFORMATION FASTENER TORQUES

## Inch Fastener Torque Values

<b>SAE Grade and Head Markings</b>	1 or 2 <sup>b</sup> No Marks 	5      5.1      5.2 	8      8.2 
<b>SAE Grade and Nut Markings</b>	2 No Marks 	5  	8  

MIF

SIZE	Grade 1				Grade 2b				Grade 5, 5.1 or 5.2				Grade 8 or 8.2			
	Lubricated a		Dry a		Lubricated a		Dry a		Lubricated a		Dry a		Lubricated a		Dry a	
	N•m	lb-ft	N•m	lb-ft	N•m	lb-ft	N•m	lb-ft	N•m	lb-ft	N•m	lb-ft	N•m	lb-ft	N•m	lb-ft
1/4	3.7	2.8	4.7	3.5	6	4.5	7.5	5.5	9.5	7	12	9	13.5	10	17	12.5
5/16	7.7	5.5	10	7	12	9	15	11	20	15	25	18	28	21	35	26
3/8	14	10	17	13	22	16	27	20	35	26	44	33	50	36	63	46
7/16	22	16	28	20	35	26	44	32	55	41	70	52	80	58	100	75
1/2	33	25	42	31	53	39	67	50	85	63	110	80	120	90	150	115
9/16	48	36	60	45	75	56	95	70	125	90	155	115	175	130	225	160
5/8	67	50	85	62	105	78	135	100	170	125	215	160	215	160	300	225
3/4	120	87	150	110	190	140	240	175	300	225	375	280	425	310	550	400
7/8	190	140	240	175	190	140	240	175	490	360	625	450	700	500	875	650
1	290	210	360	270	290	210	360	270	725	540	925	675	1050	750	1300	975
1-1/8	470	300	510	375	470	300	510	375	900	675	1150	850	1450	1075	1850	1350
1-1/4	570	425	725	530	570	425	725	530	1300	950	1650	1200	2050	1500	2600	1950
1-3/8	750	550	950	700	750	550	950	700	1700	1250	2150	1550	2700	2000	3400	2550
1-1/2	1000	725	1250	925	990	725	1250	930	2250	1650	2850	2100	3600	2650	4550	3350

DO NOT use these hand torque values if a different torque value or tightening procedure is given for a specific application. Torque values listed are for general use only and include a ±10% variance factor. Check tightness of fasteners periodically. DO NOT use air powered wrenches.

Shear bolts are designed to fail under predetermined loads. Always replace shear bolts with identical grade.

Fasteners should be replaced with the same grade. Make sure fastener threads are clean and that you properly start thread engagement. This will prevent them from failing

when tightening.

When bolt and nut combination fasteners are used, torque values should be applied to the NUT instead of the bolt head.

Tighten toothed or serrated-type lock nuts to the full torque value.

a "Lubricated" means coated with a lubricant such as engine oil, or fasteners with phosphate and oil coatings. "Dry" means plain or zinc plated (yellow dichromate - Specification JDS117) without any lubrication.

## **SPECIFICATIONS & INFORMATION FASTENER TORQUES**

---

b *“Grade 2” applies for hex cap screws (Not Hex Bolts) up to 152 mm (6 in.) long. “Grade 1” applies for hex cap screws over 152 mm (6 in.) long, and for all other types of bolts and screws of any length.*

Reference: JDS - G200

# SPECIFICATIONS & INFORMATION GENERAL INFORMATION

## General Information

### Gasoline



**CAUTION: Avoid injury! Gasoline is HIGHLY FLAMMABLE, handle it with care. DO NOT refuel machine while:**

indoors, always fill gas tank outdoors

machine is near an open flame or sparks

engine is running, STOP engine

engine is hot, allow it to cool sufficiently first  
smoking

**Help prevent fires:**

fill gas tank to bottom of filler neck only

be sure fill cap is tight after fueling

clean up any gas spills IMMEDIATELY

keep machine clean and in good repair - free of  
excess grease, oil, debris, and faulty or  
damaged parts

any storage of machines with gas left in tank  
should be in an area that is well ventilated to  
prevent possible igniting of fumes by an open  
flame or spark, this includes any appliance  
with a pilot light

To prevent fire or explosion caused by STATIC  
ELECTRIC DISCHARGE during fueling:

**ONLY use a clean, approved POLYETHYLENE  
PLASTIC fuel container and funnel WITHOUT  
any metal screen or filter**

To avoid engine damage:

- DO NOT mix oil with gasoline
- **ONLY use clean, fresh unleaded gasoline with an octane rating (anti-knock index) of 87 or higher**
- fill gas tank at the end of each day's operation to help prevent condensation from forming inside a partially filled tank
- keep up with specified service intervals

Use of alternative oxygenated, gasohol blended, unleaded gasoline is acceptable as long as:

- the ethyl or grain alcohol blends DO NOT exceed 10% by volume or

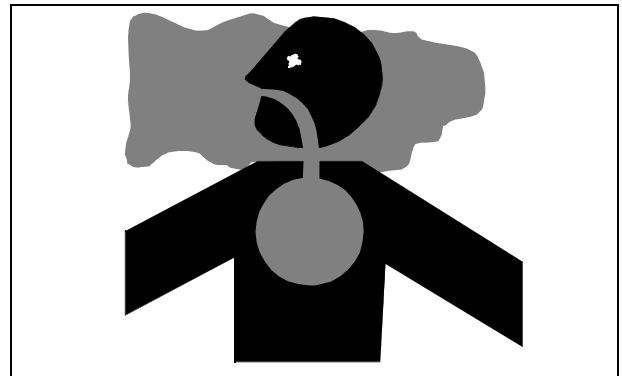

mif

- methyl tertiary butyl ether (MTBE) blends DO NOT exceed 15% by volume

**IMPORTANT: Avoid damage! DO NOT use METHANOL gasolines because METHANOL is harmful to the environment and to your health.**



**CAUTION: Avoid injury! California Proposition 65 Warning: Gasoline engine exhaust from this product contains chemicals known to the State of California to cause cancer, birth defects, or other reproductive harm.**

### Gasoline Storage

**IMPORTANT: Avoid damage! Keep all dirt, scale, water or other foreign material out of gasoline.**

Keep gasoline stored in a safe, protected area. Storage of gasoline in a clean, properly marked ("UNLEADED GASOLINE") POLYETHYLENE PLASTIC container WITHOUT any metal screen or filter is recommended. DO NOT use de-icers to attempt to remove water from gasoline or depend on fuel filters to remove water from gasoline. Use a water separator installed in the storage tank outlet. BE SURE to properly discard unstable or contaminated gasoline. When storing machine or gasoline, it is recommended that you add **John Deere Gasoline Conditioner and Stabilizer (TY15977)** or an equivalent to the gasoline. BE SURE to follow directions on container and to properly discard empty container.

# SPECIFICATIONS & INFORMATION GENERAL INFORMATION

## Engine Oil

Use the appropriate oil viscosity based on the expected air temperature range during the period between recommended oil changes. Operating outside of these recommended oil air temperature ranges may cause premature engine failure.

The following John Deere oil is PREFERRED:

- **TURF-GARD® - SAE 10W-30;**
- **PLUS-4® - SAE 10W-30;**

Other oils may be used if above John Deere oils are not available, provided they meet one of the following specifications:

- SAE 5W-30 - API Service Classification SG or higher;
- SAE 10W-30 - API Service Classification SG or higher;
- SAE 30 - API Service Classification SC or higher.

**John Deere Dealers:** You may want to cross-reference the following publications to recommend the proper oil for your customers:

- Module DX, ENOIL2 in JDS-G135;
- Section 530, Lubricants & Hydraulics, of the John Deere Merchandise Sales Guide;
- Lubrication Sales Manual PI7032.

## Engine Break-in Oil

**IMPORTANT: Avoid damage! ONLY use a quality break-in oil in rebuilt or remanufactured engines for the first 5 hours (maximum) of operation. DO NOT use oils with heavier viscosity weights than SAE 5W-30 or oils meeting specifications API SG or SH, these oils will not allow rebuilt or remanufactured engines to break-in properly.**

The following John Deere oil is PREFERRED:

- **BREAK-IN ENGINE OIL.**

John Deere BREAK-IN ENGINE OIL is formulated with special additives for aluminum and cast iron type engines to allow the power cylinder components (pistons, rings, and liners as well) to “wear-in” while protecting other engine components, valve train and gears, from abnormal wear. Engine rebuild instructions should be followed closely to determine if special requirements are necessary.

John Deere BREAK-IN ENGINE OIL is also recommended for non-John Deere engines, both aluminum and cast iron types.

The following John Deere oil is **also recommended as a break-in engine oil:**

- **TORQ-GARD SUPREME® - SAE 5W-30.**

If the above recommended John Deere oils are not available, use a break-in engine oil meeting the following specification during the first 5 hours (maximum) of operation:

- SAE 5W-30 - API Service Classification SE or higher.

**IMPORTANT: Avoid damage! After the break-in period, use the John Deere oil that is recommended for this engine.**

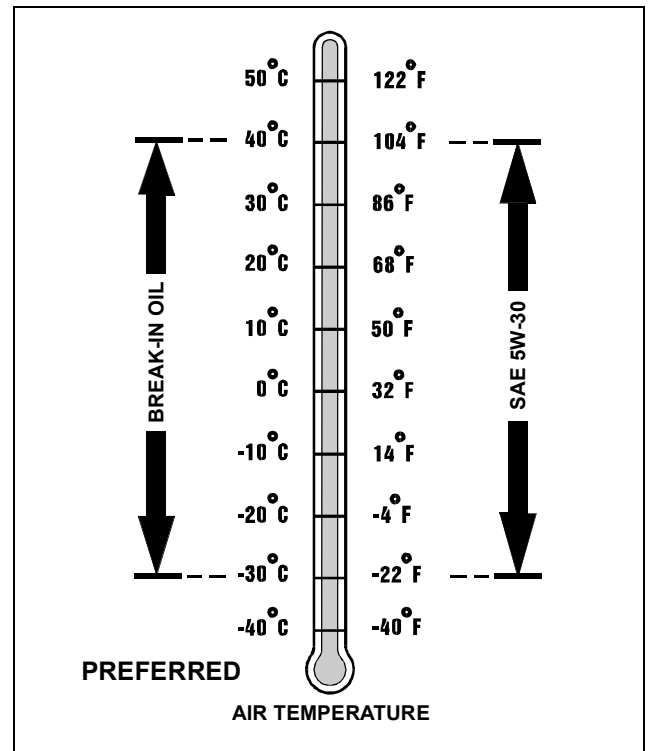

**John Deere Dealers:** You may want to cross-reference the following publications to recommend the proper oil for your customers:

- Module DX, ENOIL4 in JDS-G135;
- Section 530, Lubricants & Hydraulics, of the John Deere Merchandise Sales Guide;
- Lubrication Sales Manual PI7032.

# SPECIFICATIONS & INFORMATION GENERAL INFORMATION

## Alternative Lubricants

Conditions in certain geographical areas outside the United States and Canada may require different lubricant recommendations than the ones printed in this technical manual or the operator's manual. Consult with your John Deere Dealer, or Sales Branch, to obtain the alternative lubricant recommendations.

**IMPORTANT: Avoid damage! Use of alternative lubricants could cause reduced life of the component.**

If alternative lubricants are to be used, it is recommended that the factory fill be thoroughly removed before switching to any alternative lubricant.

## Synthetic Lubricants

Synthetic lubricants may be used in John Deere equipment if they meet the applicable performance requirements (industry classification and/or military specification) as shown in this manual.

The recommended air temperature limits and service or lubricant change intervals should be maintained as shown in the operator's manual.

Avoid mixing different brands, grades, or types of oil. Oil manufacturers blend additives in their oils to meet certain specifications and performance requirements. Mixing different oils can interfere with the proper functioning of these additives and degrade lubricant performance.

## Lubricant Storage

All machines operate at top efficiency only when clean lubricants are used. Use clean storage containers to handle all lubricants. Store them in an area protected from dust, moisture, and other contamination. Store drums on their sides. Make sure all containers are properly marked as to their contents. Dispose of all old, used containers and their contents properly.

## Mixing Of Lubricants

In general, avoid mixing different brands or types of lubricants. Manufacturers blend additives in their lubricants to meet certain specifications and performance requirements. Mixing different lubricants can interfere with the proper functioning of these additives and lubricant properties which will downgrade their intended specified performance.

## Chassis Grease

Use the following grease based on the air temperature range. Operating outside of the recommended grease air temperature range may cause premature failures.

The following John Deere grease is PREFERRED:

• **NON-CLAY HIGH-TEMPERATURE EP GREASE® - JDM J13E4, NLGI Grade 2.**

- Multi-Purpose SD Polyurea Grease
- Multi-Purpose HD Lithium Complex Grease

Other greases may be used if above preferred John Deere grease is not available, provided they meet the following specification:

- John Deere Standard JDM J13E4, NLGI Grade 2.

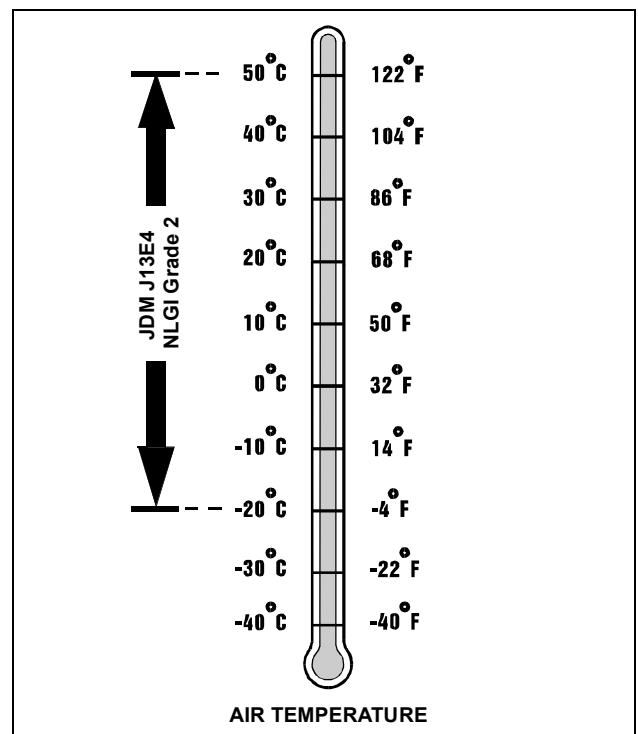

MIF

**John Deere Dealers:** You may want to cross-reference the following publications to recommend the proper grease for your customers:

- Module DX,GREA1 in JDS-G135;
- Section 530, Lubricants & Hydraulics, of the John Deere Merchandise Sales Guide;
- Lubrication Sales Manual P17032.

# SPECIFICATIONS & INFORMATION SERIAL NUMBER LOCATIONS

## Hydrostatic Transmission Oil

These machines are equipped with a internal wet disc brake transmission.

**IMPORTANT: Avoid damage! ONLY use John Deere J20C, 5W30, or 10W30 engine oil in this transmission. Mixing of two viscosity grade oils is NOT RECOMMENDED. Do Not use Lo VIS Hy Gard. Ensure that transmission is completely drained before refilling. DO NOT use type "F" automatic transmission fluid.**

**NOTE: The K46 transmission is filled with 10W30 engine oil at the factory.**

The following oil is RECOMMENDED:

- J20C Oil
- 5W30 Engine Oil
- 10W30 Oil

**John Deere Dealers:** You may want to cross-reference the following publications to recommend the proper oil for your customers:

- Module DX, ENOIL2 in JDS-G135;
- Section 530, Lubricants & Hydraulics, of the John Deere Merchandise Sales Guide;
- Lubrication Sales Manual PI7032.

## Serial Number Locations

### Machine Product Identification Number

When ordering parts or submitting a warranty claim, it is **IMPORTANT** that the machine product identification number (PIN) and component serial numbers are included. The location of the PIN and component serial numbers are shown.



Located on right side of frame.

## Engine Serial Number



**Picture Note: Single Cylinder Engine**

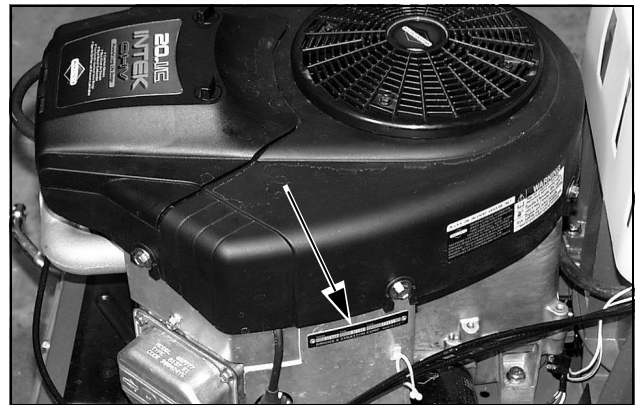

**Picture Note: V-Twin Engine**

Located on right side of engine.

### Transaxle Serial Number

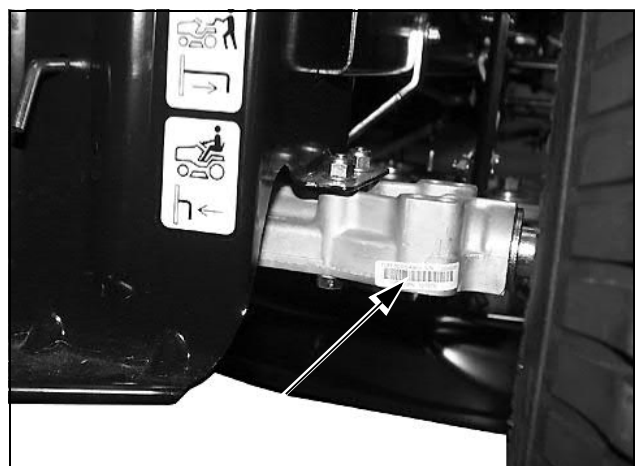

Located on back-right side of transaxle.

# ENGINE - BRIGGS & STRATTON TABLE OF CONTENTS

---

<b>Table of Contents</b>	
<b>Specifications</b> .....	<b>19</b>
General Specifications .....	19
Tests and Adjustments Specifications.....	19
Repair Specifications.....	19
Torque Specifications (Alphabetical).....	21
<b>Diagnostics</b> .....	<b>22</b>
Engine Will Not Start .....	22
<b>Tests and Adjustments</b> .....	<b>23</b>
Throttle Cable Adjustment.....	23
Fuel Shutoff Solenoid Test.....	23
Governor Adjustment - Static .....	23
Governor Adjustment - Dynamic .....	24
Governor Idle Adjustment.....	25
Slow Idle Carburetor Adjustment.....	25
Valve Clearance Adjustment .....	26
Armature Air Gap Adjustment .....	27
Cylinder Leakdown Test.....	27
<b>Fuel and Air Repair</b> .....	<b>29</b>
Upper Blower Housing Removal and Installation .....	29
Air Cleaner Service .....	29
Carburetor Removal and Installation.....	30
Carburetor Disassembly.....	31
Carburetor Inspection.....	32
Carburetor Assembly.....	32
Breather Valve Service.....	33
<b>Engine Repair</b> .....	<b>34</b>
Engine Removal .....	34
Engine Installation .....	35
Cylinder Head Removal and Installation .....	36
Cylinder Head Inspection and Repair.....	38
Valve Removal .....	38
Valves Reface .....	39
Valves Installation .....	39
Governor Removal and Installation .....	40
Piston, Rings and Rod.....	40
Piston Inspection .....	42
Connecting Rod Inspection .....	42
Cylinder Bore Inspection .....	44
Cylinder Bore Honing .....	45
Cylinder Bore Cleaning .....	45
Resizing Cylinder Bore.....	46
Flywheel Removal and Installation.....	47
Crankshaft and Cam Gear Removal .....	48
Balance System Removal and Installation.....	49
Crankshaft and Counterweight Assembly Installation.....	50
Crankshaft/Cam Gear Installation.....	50
Magneto Bearing Inspection.....	51
Cam Gear Bearing Inspection .....	52
PTO Journal Inspection and Seal Replacement .....	52
Starting Motor Removal and Installation.....	53
Starting Motor Disassembly.....	53
Starting Motor Assembly.....	55
Starting Motor Pinion Gear Replacement.....	57

# ENGINE - BRIGGS & STRATTON SPECIFICATIONS

---

## Specifications

### General Specifications

Make	Briggs & Stratton
Series	Intek
L105 Engine Model	284H07
L105 Horsepower	10.8 kW (14.5 hp)
L105 Bore	87.30 mm (3.437 in.)
L105 Displacement	465 cm <sup>3</sup> (28.42 cu in.)
L107 Engine Model	31F707
L107 Horsepower	11.9 kW (16 hp)
L107 Bore	90.47 mm (3.562 in.)
L107 Displacement	500 cm <sup>3</sup> (30.52 cu in.)
Cylinders	1
Stroke/Cycle	4
Valves	Overhead Valves
Stroke	77.77 mm (3.06 in.)
Crankcase Oil Capacity	1.4 L (1.5 qt)
Lubrication	Oil Slinger
Cooling System	Air Cooled
Air Cleaner	Paper with outer foam element
Muffler	Horizontal discharge below frame
Aspiration	Normal
Fuel Filter	Replaceable (In-Line Type)

### Tests and Adjustments Specifications

Valve Clearance	
Intake	0.08 - 0.13 mm (0.003 - 0.005 in.)
Exhaust	0.13 - 0.18 mm (0.005 - 0.007 in.)
Valve Guide Depth	0.12 - 0.15 mm (0.005 - 0.006 in.)
Slow Idle	1700 ± 50 rpm
Fast Idle	2950 ± 50 rpm
Magneto Air Gap	0.25 - 0.35 mm (0.010 - 0.014 in.)
Spark Plug Gap	0.76 mm (0.030 in.)

### Repair Specifications

#### Cylinder Bore, Pistons and Rings:

L105 Cylinder Bore Standard	
Maximum Dimension	87.33 mm (3.438 in.)
Minimum Dimension	87.30 mm (3.437 in.)

## ENGINE - BRIGGS & STRATTON SPECIFICATIONS

---

<b>L107 Cylinder Bore Standard</b>	
Maximum Dimension . . . . .	90.51 mm (3.563 in.)
Minimum Dimension . . . . .	90.47 mm (3.562 in.)
Cylinder Bore Out of Round (max) . . . . .	0.04 mm (0.002 in.)
Piston Pin (Wear Limit) . . . . .	20.29 mm (0.799 in.)
Piston Pin Bore (Wear Limit) . . . . .	20.35 mm (0.801 in.)

**Ring End Gap (Wear Limit) Case Iron Bore:**

Compression Ring (Top) . . . . .	0.64 mm (0.025 in.)
Compression Ring (Center) . . . . .	0.76 mm (0.030 in.)
Oil Ring . . . . .	0.76 mm (0.030 in.)
Compression and Oil Ring Groove Wear Limit (New Rings Installed) . . . . .	0.15 mm (0.006 in.)

**Valves:**

Valve Guide (Wear Limit) . . . . .	6.09 mm (0.240 in.)
Valve Seat Width . . . . .	0.79 - 1.98 mm (0.031 - 0.078 in.)
Valve Margin (Minimum) . . . . .	0.40 mm (0.016 in.)
Valve Face Angle . . . . .	45°
Valve Seat Narrowing Angle . . . . .	30°

**Connecting Rod and Crankshaft:**

L105 Connecting Rod Crankpin (Wear Limit) . . . . .	31.80 mm (1.252 in.)
L107 Connecting Rod Crankpin (Wear Limit) . . . . .	38.15 mm (1.502 in.)
Connecting Rod Piston Pin Bearing (Wear Limit) . . . . .	20.37 mm (0.802 in.)
Crankshaft PTO Journal (Wear Limit) . . . . .	34.95 mm (1.376 in.)
Crankshaft Magneto Journal (Wear Limit) . . . . .	34.95 mm (1.376 in.)
L105 Crankshaft Crankpin Journal (Wear Limit) . . . . .	31.50 mm (1.247 in.)
L107 Crankshaft Crankpin Journal (Wear Limit) . . . . .	38.02 mm (1.497 in.)
Crankshaft Eccentric Journal (Wear Limit) . . . . .	55.93 mm (2.202 in.)
PTO Bearing (Wear Limit) . . . . .	35.13 mm (1.383 in.)
Magneto Bearing (Wear Limit) . . . . .	35.13 mm (1.383 in.)
Crankshaft End Play . . . . .	0.05 - 0.58 mm (0.002 - 0.023 in.)
Cam Gear PTO Journal (Wear Limit) . . . . .	12.65 mm (0.498 in.)
Cam Gear Magneto Journal (Wear Limit) . . . . .	12.65 mm (0.498 in.)
Cam Lobe (Wear Limit) . . . . .	30.07 mm (1.184 in.)
Cam Gear Bearing (Wear Limit) . . . . .	12.80 mm (0.504 in.)
Compression Release Lobe . . . . .	0.25 mm (0.010 in.)

**Counterweight:**

Crankshaft Eccentric Journal (Wear Limit) . . . . .	55.93 mm (2.202 in.)
Counterweight Link Bearing (Wear Limit) . . . . .	56.13 mm (2.210 in.)

## ENGINE - BRIGGS & STRATTON SPECIFICATIONS

---

### Torque Specifications (Alphabetical)

Armature Mounting Screws . . . . .	2.8 N•m (25 lb-in.)
Blower Housing Screws . . . . .	10 N•m (85 lb-in.)
Breather Mounting Bolts . . . . .	3 N•m (25 lb-in.)
Carburetor to Intake Manifold . . . . .	8 N•m (70 lb-in.)
Carburetor Bowl Screw . . . . .	4.5 N•m (40 lb-in.)
Connecting Rod Cap Screws . . . . .	21 N•m (186 lb-in.)
Control Bracket Screws . . . . .	3.4 N•m (30 lb-in.)
Cylinder Head Cap Screws . . . . .	25 N•m (220 lb-in.)
Drive Belt Idler Pulley . . . . .	9.6 N•m (85 lb-in.)
Engine Mounting Bolts . . . . .	32 N•m (24 lb-ft)
Engine Output Pulley Assembly . . . . .	75 N•m (55 lb-ft)
Exhaust Manifold . . . . .	18.5 N•m (165 lb-in.)
Flywheel Fan Screws . . . . .	16 N•m (140 lb-in.)
Flywheel Nut . . . . .	136 N•m (100 lb-ft)
Flywheel Screen Screws . . . . .	4.5 N•m (40 lb-in.)
Fuel Pump Bracket . . . . .	7.3 N•m (65 lb-in.)
Fuel Pump to Bracket . . . . .	4.0 N•m (35 lb-in.)
Fuel Shutoff Solenoid . . . . .	4.5 N•m (40 lb-in.)
Governor Arm Lock Nut . . . . .	4.5 N•m (40 lb-in.)
Heat Shield Screws . . . . .	4.5 N•m (40 lb-in.)
Ignition Armature . . . . .	2.8 N•m (25 lb-in.)
Intake Manifold Elbow . . . . .	11.3 N•m (100 lb-in.)
Rocker Arm Adjustment Lock Nut . . . . .	6.8 N•m (60 lb-in.)
Rocker Arm Mounting . . . . .	11.3 N•m (100 lb-in.)
Starting Motor Mounting Bolts . . . . .	16 N•m (140 lb-in.)
Starting Motor Through Bolts . . . . .	5.7 N•m (50 lb-in.)
Stator to Cylinder Block . . . . .	2.3 N•m (21 lb-in.)
Spark Plug . . . . .	20 N•m (180 lb-in.)
Sump Cover . . . . .	20 N•m (180 lb-in.)
Throttle Valve Plate . . . . .	4.5 N•m (40 lb-in.)
Valve Cover Nuts . . . . .	6 N•m (55 lb-in.)
Voltage Regulator/Rectifier . . . . .	7.3 N•m (65 lb-in.)

# ENGINE - BRIGGS & STRATTON DIAGNOSTICS

---

## Diagnostics

### Engine Will Not Start



**CAUTION: Avoid Injury! Be aware! The engine may start to rotate at any time. Keep hands away from all moving parts when testing.**

**NOTE: To test specific electrical components, see Electrical section and refer to either Diagnostics or Tests and Adjustments for further guidance.**

#### Symptom: Engine Will Not Crank

- (1) Is battery voltage 12.4 volts or higher?  
**Yes** - Go to next step.  
**No** - Charge battery and perform no-load test. Go to next step.
- (2) Is battery voltage 12.4 volts or higher?  
**Yes** - Go to next step.  
**No** - Replace battery.
- (3) Does starter solenoid click when ignition switch is turned to start position?  
**Yes** - Check starter motor.  
**No** - Check electrical system.



**CAUTION: Avoid Injury! Do not rotate engine with starter if the spark plugs are removed. Gasoline spray from the open cylinders may be ignited by ignition spark and cause an explosion or fire.**

**NOTE: Perform a visual inspection first to determine if battery cables are tight and not corroded and if battery is of sufficient size to turn the engine over at minimum cranking speed of 350 rpm.**

#### Symptom: Engine Cranks But Will Not Start

- (1) Is battery voltage 12.4 volts or higher?  
**Yes** - Go to next step.  
**No** - Charge battery and perform no-load test. Go to next step.
- (2) Does fuel shutoff solenoid click when ignition switch is turned to start/run?  
**Yes** - Go to next step.

#### Symptom: Engine Cranks But Will Not Start

**No** - Defective fuel shutoff solenoid, switch or wiring. See Electrical section.

##### (3) Does engine crank slow?

**Yes** - Remove spark plugs and turn the engine over by hand. Go to next step.

**No** - Go to next step.

##### (4) Is the engine hard to turn over by hand?

**Yes** - Pistons or other internal components binding.

**No** - Starter motor possibly defective. Repair or replace as needed.

##### (5) Is the choke operating properly?

**Yes** - Go to next step.

**No** - Adjust choke cable.

##### (6) Does spark plug have strong blue spark?

**Yes** - Go to next step.

**No** - Possible defective spark plug, magneto shorted to ground, flywheel magnet weak, or ignition coil air gap not adjusted. See Electrical section.

##### (7) Are tappets adjusted properly.

**Yes** - Go to next step.

**No** - Adjust tappets.

##### (8) Is engine getting fuel?

**Yes** - Check air cleaner, fuel mixture, possible contaminated fuel, or stuck float needle.

**No** - Check fuel shutoff valve, fuel lines, fuel pump, and engine vacuum.

#### Symptom: Engine Makes High Whining Sound

##### (1) Are the starter gears engaging and disengaging correctly?

**Yes** - Go to next step.

**No** - Check starting motor gears for correct engagement and disengagement. See "Starting Motor Removal and Installation" on page 53.

##### (2) Are the cam and crank gears engaging correctly?

**No** - Check cam shaft end play.



**Suggest:**

**If the above button click is invalid.**

**Please download this document**

**first, and then click the above link**

**to download the complete manual.**

**Thank you so much for reading**

# ENGINE - BRIGGS & STRATTON TESTS AND ADJUSTMENTS

## Tests and Adjustments

### Throttle Cable Adjustment

#### Reason:

To make sure the throttle cable moves the throttle through its full range of movement.

#### Procedure:

1. Move throttle lever to FAST idle position (detent).

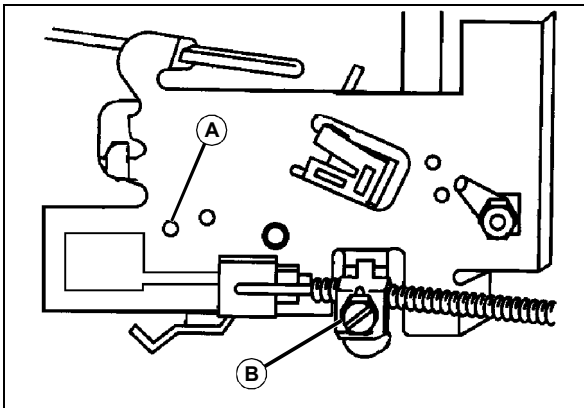

M95232

2. Hole in governor control lever must align with hole (A) in governor control plate.
3. Loosen throttle cable clamp (B).
4. Slide the throttle cable left or right to align holes.
5. Tighten throttle cable clamp (B).

### Fuel Shutoff Solenoid Test

#### Reason:

To test proper operation of fuel shutoff solenoid.

#### Required Tools:

- Jumper wire

#### Procedure:

1. Listen for an audible click when ignition switch is turned from OFF to ON.
2. If solenoid does not click, problem could be in equipment wiring.

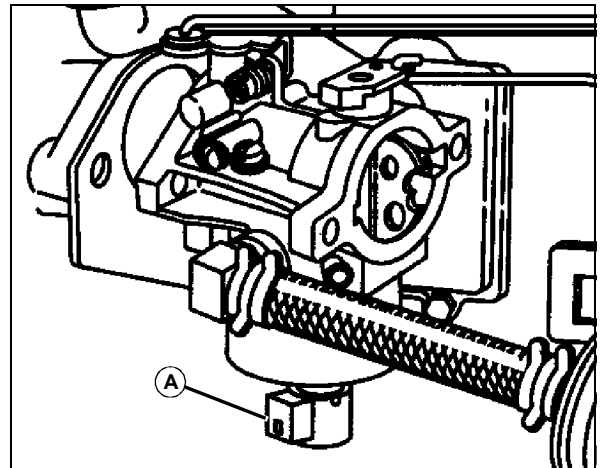

M95224

3. Disconnect wire from solenoid (A).
4. Momentarily place a jumper wire from solenoid terminal to battery positive terminal.

**NOTE:** If battery voltage drops below 9 volts when cranking engine or while engine is running, the solenoid will not function.

5. If solenoid now clicks, the solenoid is working properly.

#### Results:

- Solenoid is operating properly if a click is heard when ignition switched from OFF to ON.

### Governor Adjustment - Static

(Engine OFF)



**CAUTION:** Avoid Injury! Before starting or running engine, static adjustment of the governor must be made. Failure to make static adjustments first, could result in engine overspeeding, and may result in engine or equipment damage causing personal injury and/or property damage.

**NOTE:** All linkage must be installed to make adjustment.

#### Reason:

To set the initial engine speed limits.

**<https://www.ebooklibonline.com>**

Hello dear friend!

Thank you very much for reading.

Enter the link into your browser.

The full manual is available for immediate download.

**<https://www.ebooklibonline.com>**