

JOHN DEERE
WORLDWIDE COMMERCIAL & CONSUMER
EQUIPMENT DIVISION

Walk-Behind Rotary Mower
JX75

OMGX21224 J2

OPERATOR'S MANUAL



JOHN DEERE

North American Version
Litho in U.S.A.

INTRODUCTION

Thank You for Purchasing a John Deere Product

We appreciate having you as a customer and wish you many years of safe and satisfied use of your machine.

Using Your Operator's Manual

This manual is an important part of your machine and should remain with the machine when you sell it.

Reading your operator's manual will help you and others avoid personal injury or damage to the machine. Information given in this manual will provide the operator with the safest and most effective use of the machine. Knowing how to operate this machine safely and correctly will allow you to train others who may operate this machine.

This manual and safety signs on your machine may also be available in other languages (see your John Deere dealer to order).

Sections in your operator's manual are placed in a specific order to help you understand all the safety messages and learn the controls so you can operate this machine safely. You can also use this manual to answer any specific operating or servicing questions. A convenient index located at the end of this book will help you to find needed information quickly.

The machine shown in this manual may differ slightly from your machine, but will be similar enough to help you understand our instructions.

RIGHT and LEFT sides are determined by facing in the direction the machine will travel when going forward. When you see a broken line (-----), the item referred to is hidden from view.

Setting fuel delivery beyond published factory specifications or otherwise overpowering will result in loss of warranty protection for this machine.

Before delivering this machine, your dealer performed a predelivery inspection to ensure best performance.

Special Messages

Your manual contains special messages to bring attention to potential safety concerns, machine damage as well as helpful operating and servicing information. Please read all the information carefully to avoid injury and machine damage.



CAUTION: Avoid injury! This symbol and text highlight potential hazards or death to the operator or bystanders that may occur if the hazards or procedures are ignored.

IMPORTANT: Avoid damage! This text is used to tell the operator of actions or conditions that might result in damage to the machine.

NOTE: General information is given throughout the manual that may help the operator in the operation or service of the machine.

CALIFORNIA Proposition 65 Warning



Warning: The Engine Exhaust from this product contains chemicals known to the State of California to cause cancer, birth defects or other reproductive harm.

PRODUCT IDENTIFICATION

Record Identification Numbers

21-Inch Walk-Behind Rotary Mowers

JX75 PIN (110001-)

If you need to contact an Authorized Service Center for information on servicing, always provide the product model and serial number.

You will need to locate the model and serial number for the machine and for the engine of your machine and record the information in the spaces provided below.

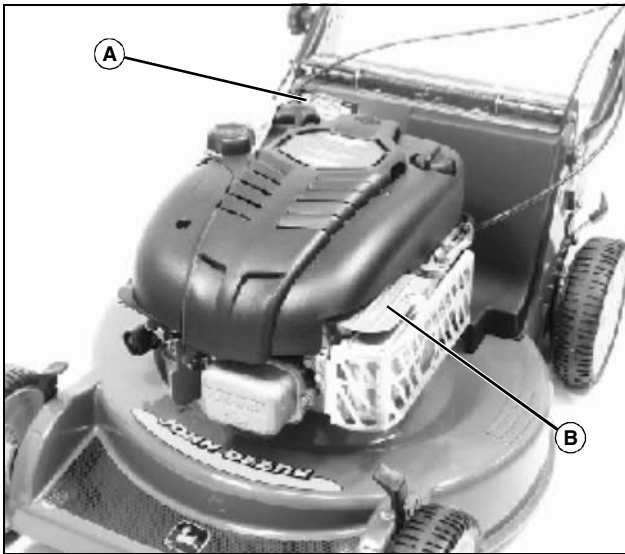

MX7431

DATE OF PURCHASE:

DEALER NAME:

DEALER PHONE:

PRODUCT IDENTIFICATION NUMBER (A):

ENGINE SERIAL NUMBER (B):

<https://www.ebooklibonline.com>

Hello dear friend!

Thank you very much for reading.

Enter the link into your browser.

The full manual is available for immediate download.

<https://www.ebooklibonline.com>

TABLE OF CONTENTS

Safety	1
Operating	7
Replacement Parts	14
Service Intervals	15
Service	16
Troubleshooting	26
Storage	28
Assembly	31
Specifications	33
Warranty	35
Index.....	38

All information, illustrations and specifications in this manual are based on the latest information at the time of publication. The right is reserved to make changes at any time without notice.

COPYRIGHT© 2002

Deere & Co.

John Deere Worldwide Commercial and Consumer Equipment Division

All rights reserved

Previous Editions

COPYRIGHT© 1998, 1997, 1996, 1995, 1994, 1992, 1991, 1990, 1989, 1988

OMGX21224 J2 - English

SAFETY

Understanding The Machine Safety Labels

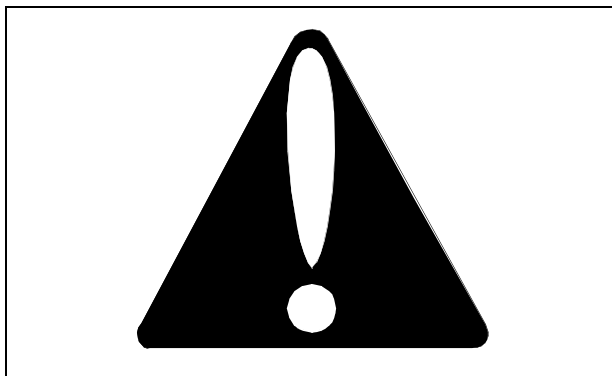

MIF

The machine safety labels shown in this section are placed in important areas on your machine to draw attention to potential safety hazards.

On your machine safety labels, the words DANGER, WARNING, and CAUTION are used with this safety-alert symbol. DANGER identifies the most serious hazards.

The operator's manual also explains any potential safety hazards whenever necessary in special safety messages that are identified with the word, CAUTION, and the safety-alert symbol.

DANGER

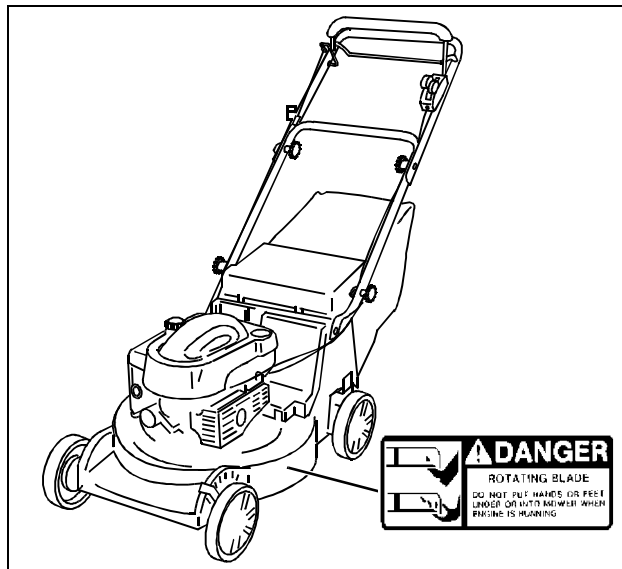

MIF, M73170

ROTATING BLADE

DO NOT PUT HANDS OR FEET UNDER OR INTO MOWER WHEN ENGINE IS RUNNING

DANGER



MIF, M73171

KEEP HANDS and FEET AWAY
CUTTING BLADES

WARNING

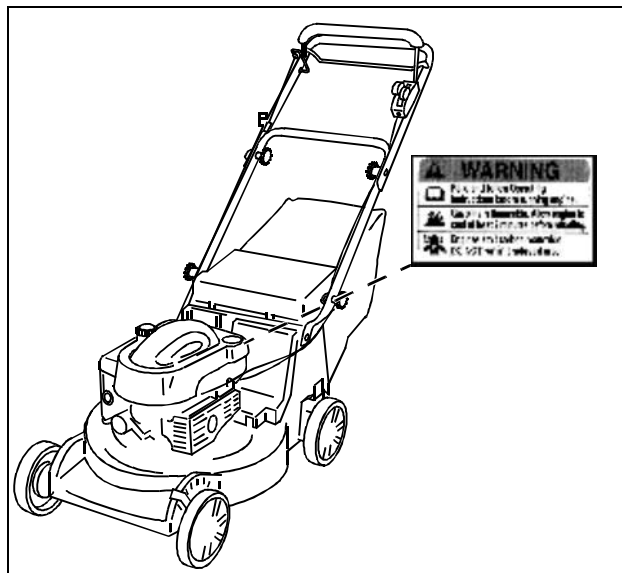

MIF, MX4878

- Read and follow Operating Instructions before running engine.
- Gasoline is flammable. Allow engine to cool at least 2 minutes before refueling.
- Engines emit carbon monoxide, DO NOT run in enclosed area.

SAFETY

DANGER

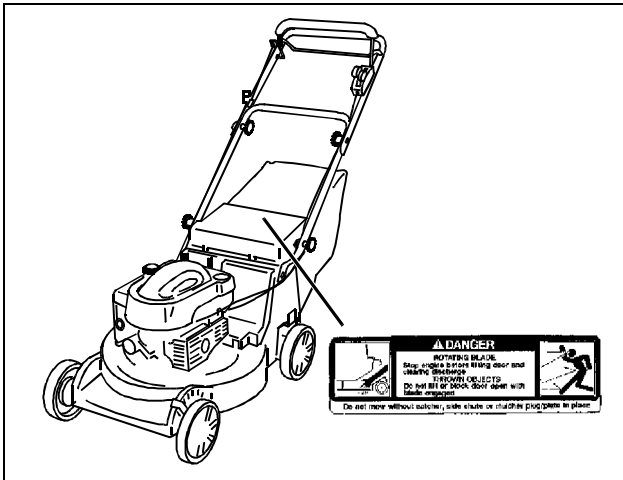

MIF, M73467

ROTATING BLADE

Stop engine before lifting door and clearing discharge
THROWN OBJECTS

Do not lift or block door open with blade engaged

Do not mow without catcher, side chute or mulcher plug/plate in place

WARNING

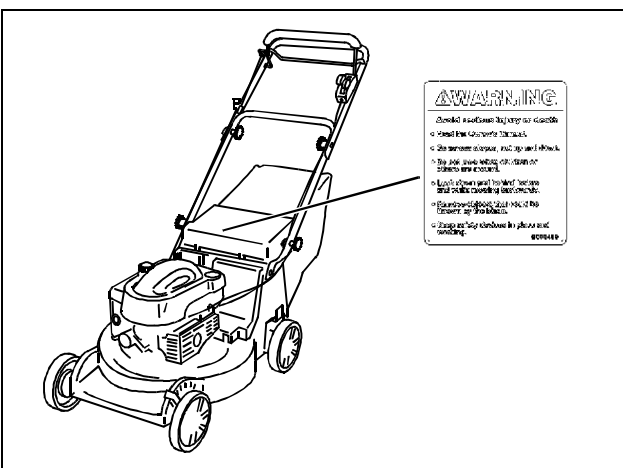

MIF, GC00489

Avoid serious injury or death

- Read the Owner's Manual.
- Go across slopes, not up and down.
- Do not mow when children or others are around.
- Look down and behind before and while mowing backwards.
- Remove objects that could be thrown by the blade.

- Keep safety devices in place and working.

CAUTION

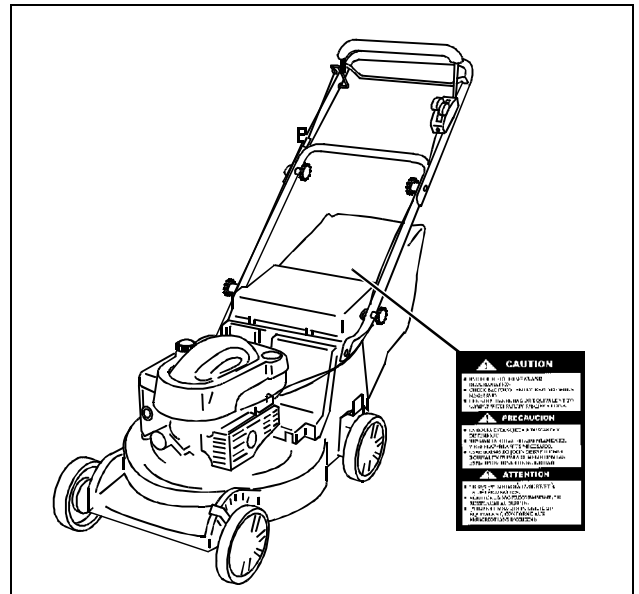

MIF, M96543

- BAG IS SUBJECT TO WEAR AND DETERIORATION.
- CHECK BAG FREQUENTLY. REPLACE WHEN NECESSARY.
- USE JOHN DEERE BAG OR EQUIVALENT TO COMPLY WITH SAFETY SPECIFICATIONS.

Emission Control System Certification Label

NOTE: Tampering with emission controls and components by unauthorized personnel may result in severe fines or penalties. Emission controls and components can only be adjusted by EPA and/or CARB authorized service centers. Contact your John Deere Commercial and Consumer Equipment Retailer concerning emission controls and component questions.

The presence of an emissions label signifies that the engine has been certified with the United States Environmental Protection Agency (EPA) and/or California Air Resources Board (CARB).

The emissions warranty applies only to those engines marketed by John Deere that have been certified by the EPA and/or CARB; and used in the United States and Canada in off-road mobile equipment.

SAFETY

Emission Compliance Period

If your engine has the emission compliance category listed on the emission control system certification or air index label, this indicates the number of operating hours for which the engine has been certified to meet EPA and/or CARB emission requirements. The following table provides the engine compliance period in hours associated with the category found on the certification label.

Agency	Category	Hours
EPA	C	250
EPA	B	500
EPA	A	1000
CARB	Moderate	125
CARB	Intermediate	250
CARB	Extended	500

Certification

Your mower has been certified by an independent laboratory for compliance with American National Standard B-71.1, "Safety Specifications" for Power Lawn Mowers, Lawn and Garden Tractors, and Lawn Tractors.

Operating Safely

- Read, understand and follow all instructions in the manual, on the machine and on the safety video before starting.
- Only allow responsible adults, who are familiar with the instructions to operate the machine.
- Inspect machine before you operate. Be sure hardware is tight. Repair or replace damaged, badly worn, or missing parts. Be sure guards and shields are in good condition and fastened in place. Make any necessary adjustments before you operate.
- Do not operate mower without discharge chute or entire grass catcher in place.
- Check brake action before you operate. Adjust or service brakes as necessary.
- Stop machine if anyone enters the area.
- If you hit an object, stop the machine and inspect it. Make repairs before you operate. Keep machine and attachments properly maintained and in good working order.

- Be aware of the mower discharge direction and make sure that no one is in the path of the discharge direction.
- Do not leave machine unattended when it is running.
- Only operate during daylight or with good artificial light.
- Be careful of traffic when operating near or crossing roadways.
- Older adults are involved in a large percentage of riding mower accidents involving injury. These operators should evaluate their ability to operate a mower safely enough to protect the operator and others from serious injury.

Rotating Blades are Dangerous - Protect Children and Prevent Accidents

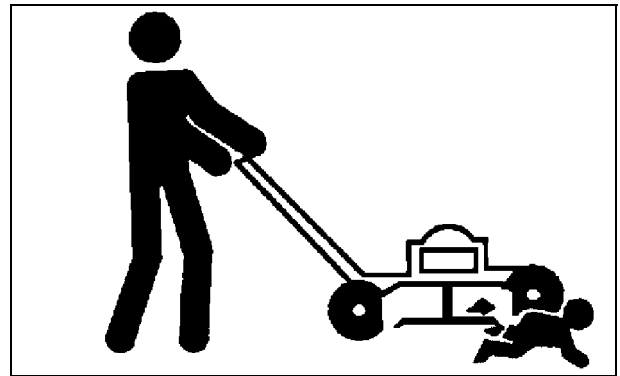

M61473

Protect Children:

- Never assume that children will remain where you last saw them. Children are attracted to mowing activity, stay alert to the presence of children.
- Keep children in the house when you are operating the machine.
- Turn machine off if a child enters the area.
- Use extra care when you come to blind corners, shrubs, trees, or other objects that may block your vision.
- Do not let children or an untrained person operate the machine.

Help Prevent Serious or Fatal Accidents:

- Be alert at all times, people especially children can move quickly into the area before you know it.
- Stop the blade when crossing gravel drives, walks, or roads.
- Shut off blades when you are not mowing.
- Keep hands, feet, and clothing away from rotating blades.

SAFETY

Wear Appropriate Clothing

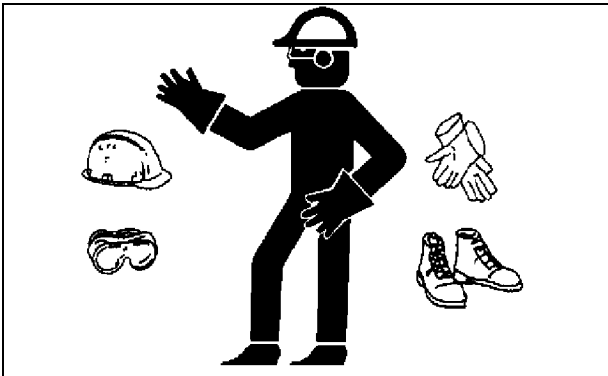

TS206TR

- Wear close fitting clothing and safety equipment appropriate for the job.
- Always wear safety goggles or safety glasses with side shields when operating the mower.
- Wear a suitable protective device such as earplugs. Loud noise can cause impairment or loss of hearing.
- Do not wear radio or music headphones. Safe service and operation requires your full attention.

Practice Safe Maintenance



TS218

- Understand service procedure before doing work. Keep area clean and dry.
- Never lubricate, service, or adjust machine while it is moving. Keep safety devices in place and in working condition. Keep hardware tight.
- Keep hands, feet, clothing, jewelry, and long hair away from any moving parts, to prevent them from getting caught.
- Lower attachments to the ground before servicing machine. Disengage all power and stop the engine. Lock park brake and remove the key. Let machine cool.
- Disconnect battery or remove spark plug wire before

making any repairs.

- Keep all nuts and bolts tightened, especially blade attachment bolts.
- Securely support any machine elements that must be raised for service work.
- Never run engine unless park brake is locked.
- Keep all parts in good condition and properly installed. Fix damage immediately. Replace worn or broken parts. Replace all worn or damaged safety and instruction decals.
- To prevent fires, remove any buildup of grease, oil, or debris from the machine, especially the engine compartment.
- Charge battery in an open, well-ventilated area, away from sparks. Unplug battery charger before connecting or disconnecting from the battery. Use insulated tools.
- Do not modify machine or safety devices. Unauthorized modifications may impair its function and safety.
- Do not wear radio or music headphones while servicing the machine. Safe service requires your full attention.

Avoid Injury from Contacting Blade

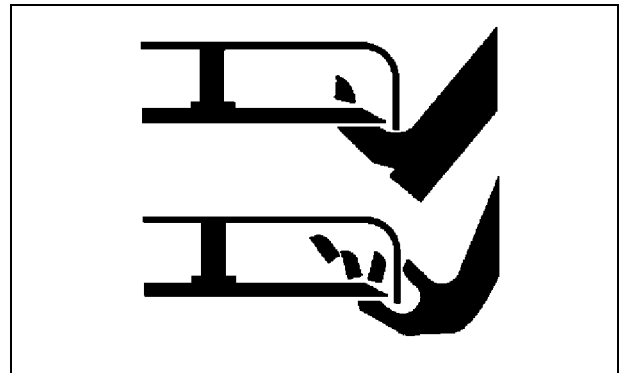

M41421

Before you unplug or adjust machine:

- Stop the engine.
- Wait for blade to stop.
- Keep hands, feet and clothing away from blade when engine is running.

SAFETY

Prevent Fires

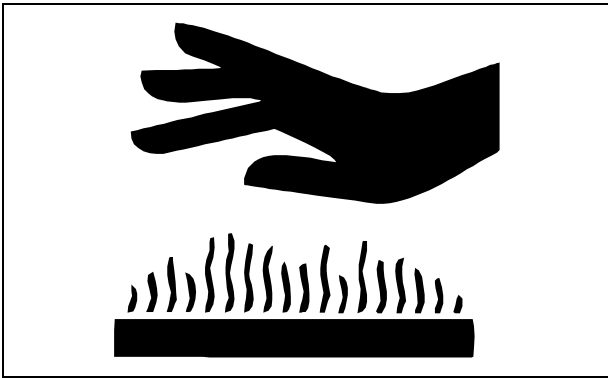

MIF

- Remove grass and debris from engine compartment and muffler area, before and after operating machine, especially after mowing or mulching in dry conditions.
- To reduce fire hazard, keep engine and engine compartment free of grass, leaves, or excessive grease.
- Allow engine to cool before storing in any enclosure.
- Never remove fuel cap, or add fuel with engine running or hot. Allow engine to cool for several minutes.
- Never store equipment with fuel in the tank inside a building where fumes may reach an open flame or spark.

Handling Fuel Safely

Fuel and fuel vapors are highly flammable:

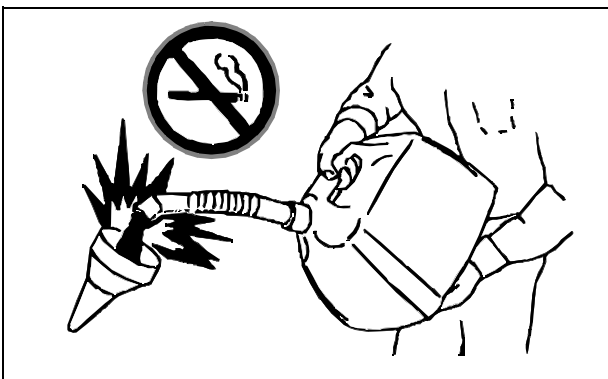

MIF

- Do not refuel machine while you smoke, when machine is near an open flame or sparks, or when engine is running. Stop engine and allow to cool before filling.
- Never remove the fuel cap or add fuel with the engine running.
- Never fill fuel tank or drain fuel from a machine in an enclosed area. Fill fuel tank outdoors.
- Prevent fires. Clean up spilled fuel immediately.

- Do not store machine with fuel in tank in a building where fumes may reach an open flame or spark.
- Prevent fire and explosion caused by static electric discharge. Use only non-metal, portable fuel containers approved by the Underwriter's Laboratory (U.L.) or the American Society for Testing & Materials (ASTM). If using a funnel, make sure it is plastic and has no screen or filter.



MIF

- Static electric discharge can ignite gasoline vapors in an ungrounded fuel container. Remove the fuel container from the bed of a vehicle or the trunk of a car and place on the ground away from the vehicle before filling. Keep nozzle in contact with container opening while filling.
- When practical, remove equipment from trailers or truck beds and refuel them on the ground. If this is not possible, use a portable, plastic fuel container to refuel equipment on a truck bed or trailer.
- For gasoline engines, do not use gas with methanol. Methanol is harmful to your health and to the environment.

Handling Waste Product and Chemicals

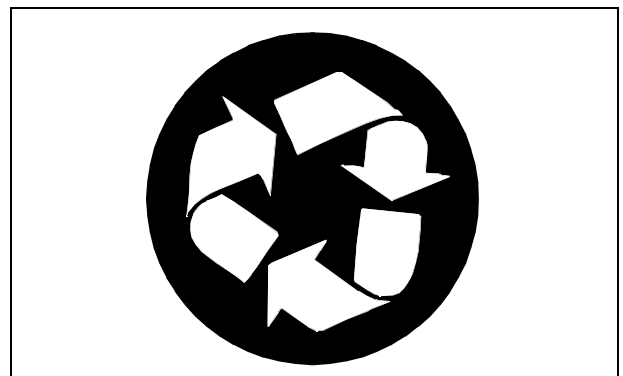

MIF

Waste products, such as, used oil, fuel, coolant, brake fluid, and batteries, can harm the environment and people:

- Do not use beverage containers for waste fluids - someone may drink from them.

SAFETY

- See your local Recycling Center or John Deere dealer to learn how to recycle or get rid of waste products.
- A Material Safety Data Sheet (MSDS) provides specific details on chemical products: physical and health hazards, safety procedures, and emergency response techniques. The seller of the chemical products used with your machine is responsible for providing the MSDS for that product.

OPERATING

Daily Operating Checklist

- Test safety systems.
- Check fuel level.
- Check engine oil level.
- Remove grass and debris from machine.
- Check area below machine for leaks.

Avoid Damage to Plastic and Painted Surfaces

- Do not wipe plastic parts unless rinsed first.
- Insect repellent spray may damage plastic and painted surfaces. Do not spray insect repellent near machine.
- Be careful not to spill fuel on machine. Fuel may damage surface. Wipe up spilled fuel immediately.

Avoid Damage to Aluminum Mower Deck

- Clean under mower deck to remove harmful buildup of lawn chemicals.
- Use regular water pressure to clean under deck. Do not use high pressure spray. High pressure spray may damage clutch and transmission parts.

Engine Controls

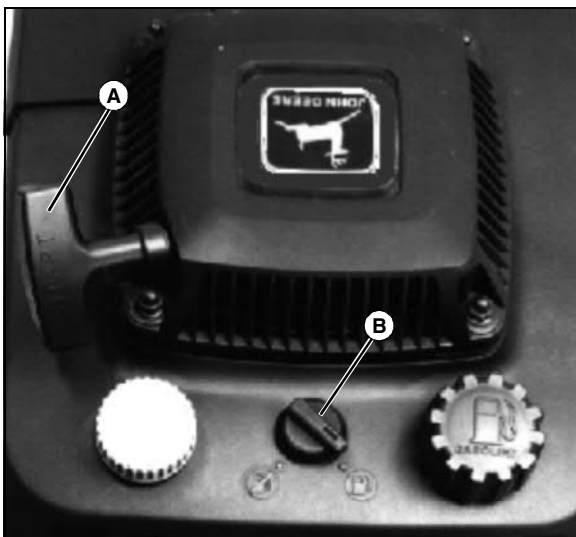

M61447

- A - Starter Handle**
- B - Fuel Shutoff Knob**

Handle Controls

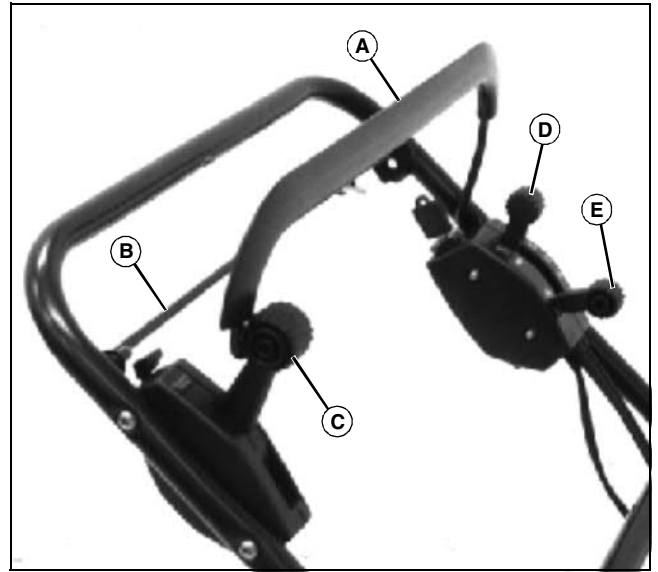

M60970

- A - Blade Lockout and Stop Lever**
- B - Traction Clutch Lever**
- C - Blade Engagement Lever**
- D - Gear Shift Lever**
- E - Throttle Lever**

Handle and Cutting Height Controls

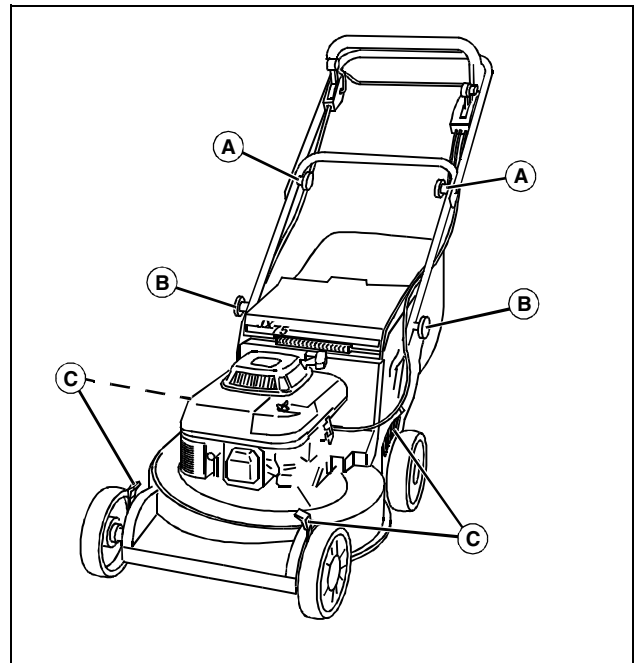

MIF

- A - Fold Handle Knobs**

OPERATING

- B - Handle Height Knob
- C - Cutting Height Levers

Adjusting Cutting Height



CAUTION: Avoid injury! Before you adjust cutting height:

- Stop engine.

NOTE: Adjust both levers to same height except for lowest cutting height. This adjustment improves mulching performance at lowest cutting height:

- Put front wheel levers in the first rear notch: 13 mm (1/2 in.).
- Put rear wheel levers in the second rear notch: 25 mm (1 in.).

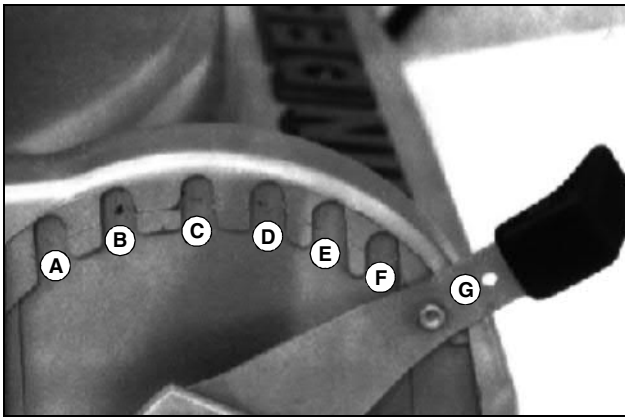

M73261

Picture Note: Right front shown above

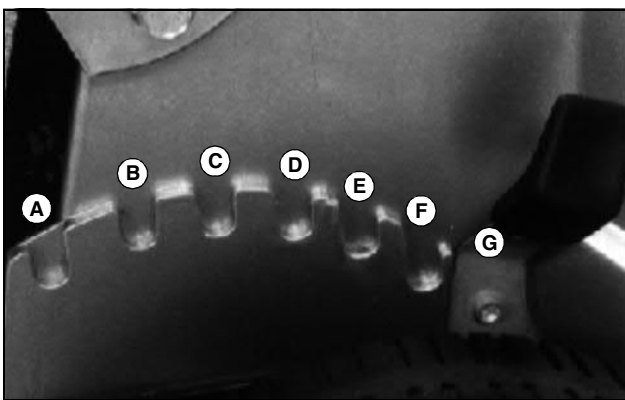

M73260

Picture Note: Right rear shown above

Key	Cutting Height Adjustments In mm (Inches)
(A)	13 mm (1/2 in.)

Key	Cutting Height Adjustments In mm (Inches)
(B)	25 mm (1 in.)
(C)	38 mm (1-1/2 in.)
(D)	50 mm (2 in.)
(E)	64 mm (2-1/2 in.)
(F)	75 mm (3 in.)
(G)	90 mm (3-1/2 in.)

To help move rear wheel levers:

1. Lift lower handlebar slightly with one hand to take some weight off wheel.
2. Move lever to desired position with other hand.

Adjusting Handle Height

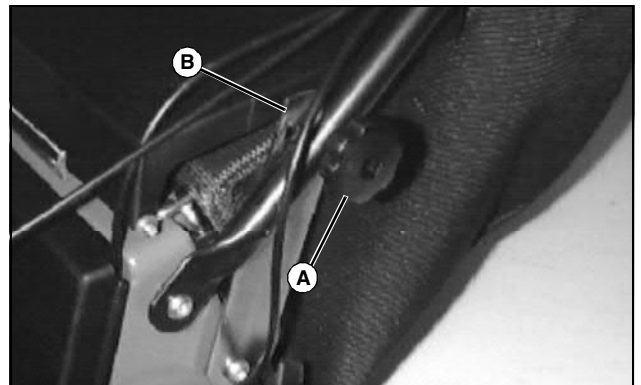

M88841

1. Remove knob (A) and bolt from each side.
2. Move handle to desired height.

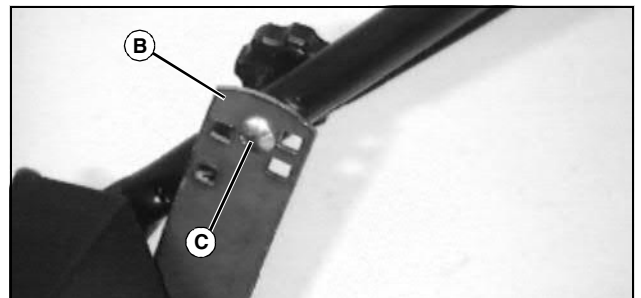

M87080

Picture Note: Rear grass bag removed for clarity.

3. Line up square hole in bracket (B) with hole in handle.
4. Install carriage bolt (C) through holes. Install knob.
5. Repeat Steps 2 - 4 on other side.



Suggest:

If the above button click is invalid.

Please download this document

first, and then click the above link

to download the complete manual.

Thank you so much for reading

OPERATING

Using Fuel Shutoff

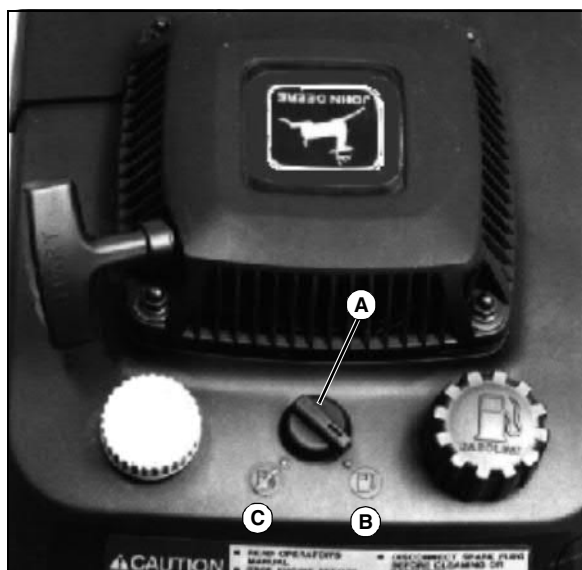

M61447

1. Turn the fuel shutoff knob so pointer (A) is toward the OPEN position (B) when operating mower.
2. Turn the fuel shutoff knob (A) so pointer is toward the CLOSED position (C) when you are not operating mower.

Testing Safety Systems

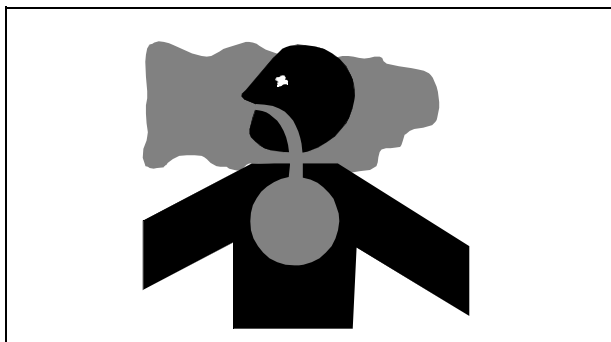

CAUTION: Avoid injury! Engine exhaust fumes contain carbon monoxide and can cause serious illness or death.

Move the machine to an outside area before running the engine.

Do not run an engine in an enclosed area without adequate ventilation.

- Connect a pipe extension to the engine exhaust pipe to direct the exhaust fumes out of the area.
- Allow fresh outside air into the work area to clear the exhaust fumes out.

Use the following checkout procedure to check for normal operation of machine.

If there is a malfunction during one of these procedures, do not operate machine. **See your John Deere dealer for service.**

Perform these tests in a clear open area. Keep bystanders away.

Testing Blade/Engine Control Lever

1. Start engine.
2. Release blade/engine control lever.



CAUTION: Avoid injury! Rotating blades are dangerous. Do not look under mower or put hands under mower to view blade rotation. Listen for blade to stop.

3. Listen for blade and engine to stop.

Result: Blade and engine should stop within three seconds. If blade and engine do not stop in the correct time, there is a problem with your machine safety system.

Starting Engine



CAUTION: Avoid injury! Engine exhaust fumes can cause sickness or death.

Run engine only in a ventilated area.

If engine is run in an enclosed area, open doors to bring in outside air.

<https://www.ebooklibonline.com>

Hello dear friend!

Thank you very much for reading.

Enter the link into your browser.

The full manual is available for immediate download.

<https://www.ebooklibonline.com>