

JX75 and JE75 21-Inch Walk-Behind Rotary Mowers

JX75 (Serial No. 030001 –)
JE75 (Serial No. 020001 –)

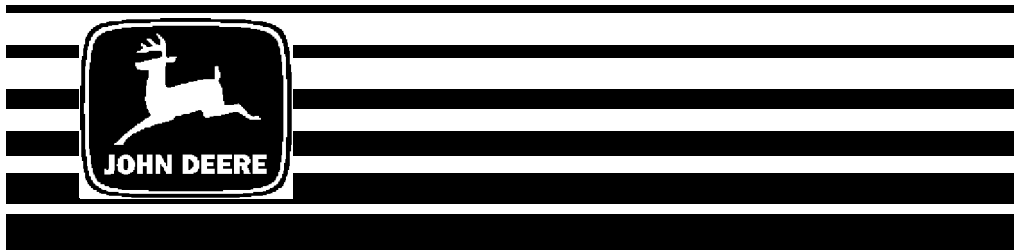

OPERATOR'S MANUAL

**John Deere
Worldwide Commercial and
Consumer Equipment Division
OMGC00313 I8**

North American Version
Litho in U.S.A
English

TABLE OF CONTENTS

	Page
Safety Signs	1
Controls	4
Operating	6
Lawn Care	18
Replacement Parts	23
Service Machine Safely	24
Service	26
Troubleshooting	51
Storing Machine	54
Assembly	58
Specifications	62
Warranty	65
Index	71
John Deere Service Literature	77

All information, illustrations and specifications in this manual are based on the latest information at the time of publication. The right is reserved to make changes at any time without notice.

COPYRIGHT© 1998
Deere & Co.
John Deere Worldwide Commercial and
Consumer Equipment Division
Horicon, WI
All rights reserved
Previous Editions
COPYRIGHT© 1997, 1996, 1995, 1994,
1992, 1991, 1990, 1989, and 1988

<https://www.ebooklibonline.com>

Hello dear friend!

Thank you very much for reading.

Enter the link into your browser.

The full manual is available for immediate download.

<https://www.ebooklibonline.com>

SAFETY SIGNS

Safety-Alert Symbol

Read and recognize safety information. Be alert to the potential for personal injury when you see this safety-alert symbol.

On your machine safety labels, the words DANGER, WARNING, and CAUTION are used with this safety-alert symbol. DANGER identifies the most serious hazards. In this manual, the word CAUTION and this symbol call attention to safety messages.



Machine Safety Labels

DANGER - Keep Hands and Feet Away.

Cutting Blades.



DANGER - Rotating Blade

Do not put hands or feet under or into mower when engine is running.

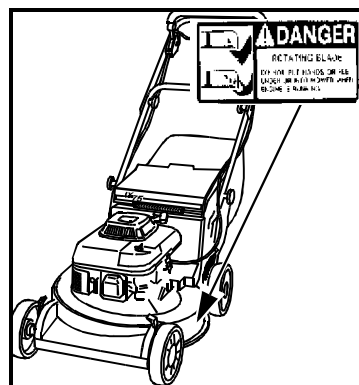

SAFETY SIGNS

CAUTION

- Bag is subject to wear and deterioration.
- Check bag frequently, replace when necessary.
- Use John Deere bag or equivalent to comply with safety specifications.

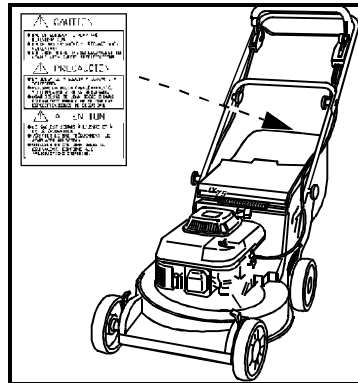

DANGER

ROTATING BLADE

Stop engine before lifting door and cleaning discharge.

THROWN OBJECTS

Do not lift or block door open with blade engaged.

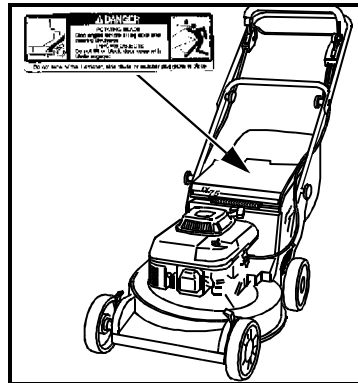

CAUTION - Help Avoid Injuries

- Pick up objects that blade may hit and throw
- Keep children and bystanders far away
- Stop engine before adjusting cutting height
- Read operator's manual

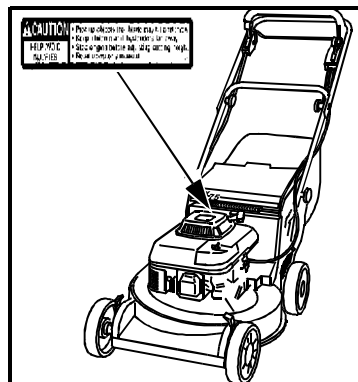

SAFETY SIGNS

Certification Label

This OPEI label on your mower indicates that this model has been certified by an independent laboratory for compliance with American National Standard B-71.1-1996, "Safety Specifications" for Power Lawn Mowers, Lawn and Garden Tractors, and Lawn Tractors.

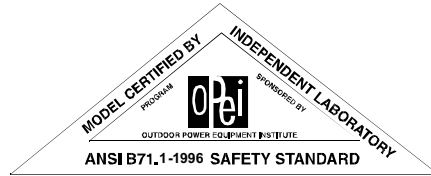

CONTROLS

Engine Controls



- A - Starter Handle Pull to start engine
- B - Fuel Shutoff Knob Controls fuel flow to engine

Handle Controls

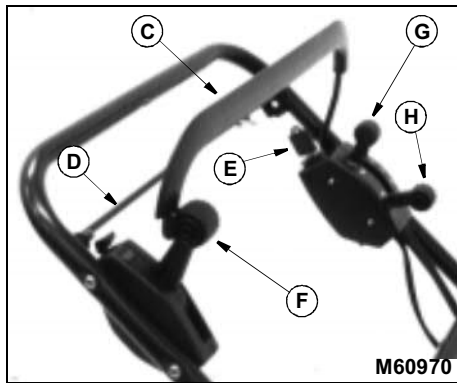

- C - Blade Lockout and Stop Lever Stops blades
- D - Traction Clutch Lever Engages traction
- E - Key (Model JE75) Starts engine
- F - Blade Engagement Lever Starts blades
- G - Gear Shift Lever Changes gears
- H - Throttle Lever Controls engine speed

CONTROLS

Handle and Cutting Height Controls

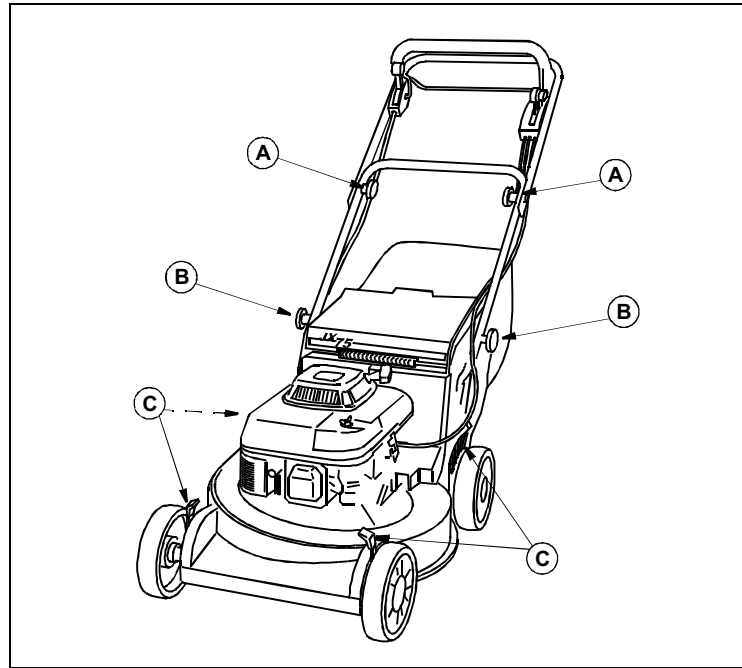

- A - Fold Handle Knobs Folds handle**
- B - Handle Height Knob Adjusts handle height**
- C - Cutting Height Levers Adjusts cutting height**

OPERATING

SAFETY

Operate Safely



- Inspect machine before you operate. Be sure hardware is tight. Repair or replace damaged, badly worn, or missing parts. Be sure proper guards, plates, grass catcher, or other safety protective devices are in good condition and fastened in place. Make any necessary adjustments before you operate.
- Clear work area of objects that might be thrown. Keep people and pets out of the work area. Stop machine if anyone enters the area.
- If you hit an object, stop the machine and inspect it. Make repairs before you operate. Keep machine properly maintained and in good working order.
- DO NOT leave machine unattended when it is running.
- Only operate during daylight or with good artificial light.
- Be sure of footing. Be especially careful when you pull machine backwards with the engine running.
- Mow across a hill - not up and down. Be careful when you change direction on a slope. Do Not mow excessively steep slopes.
- DO NOT mow wet grass. Reduced traction could cause you to slip.
- Keep a firm hold on the machine handle.
- DO NOT wear radio or music headphones while operating the machine. Safe operation requires your full attention.
- DO NOT operate mower if you are under the influence of drugs or alcohol.

OPERATING

Rotating Blades are Dangerous - Protect Children and Prevent Accidents



PROTECT CHILDREN:

- Never assume that children will remain where you last saw them. Children are attracted to mowing activity, stay alert to the presence of children.
- Keep children in the house when you are operating the machine.
- Turn machine off if a child enters the area.
- Use extra care when you come to blind corners, shrubs, trees, or other objects that may block your vision.
- DO NOT let children or an untrained person operate the machine.

HELP PREVENT SERIOUS OR FATAL ACCIDENTS:

- Be alert at all times, people especially children can move quickly into the area before you know it.
- Stop the blade when crossing gravel drives, walks, or roads.
- Shut off blades when you are not mowing.
- Keep hands, feet, and clothing away from rotating blades.

Wear Appropriate Clothing



- Wear close fitting clothing and safety equipment appropriate for the job.
- Do Not operate the equipment when barefoot or wearing open sandals. Always wear substantial footwear.
- Loud noise can cause impairment or loss of hearing, wear a suitable protective device such as earplugs.

OPERATING

ADJUSTMENTS

Adjusting Cutting Height



CAUTION: Before you adjust cutting height:
• STOP ENGINE.

IMPORTANT: Adjust all levers to same height except for **LOWEST** cutting height (A):

- Put front wheel levers in 13 mm (1/2 in.) notch: **First rear notch.**
- Put rear wheel levers in 25 mm (1 in.) notch: **Second rear notch.**

To help move rear wheel levers:

1. Lift lower handlebar slightly with one hand to take some weight off wheel.
2. Move lever to desired position with other hand.

Key	Cutting Height Adjustments In mm (Inches)
(A)	13 mm (1/2 in.)
(B)	25 mm (1 in.)
(C)	38 mm (1-1/2 in.)
(D)	50 mm (2 in.)
(E)	64 mm (2-1/2 in.)
(F)	75 mm (3 in.)
(G)	90 mm (3-1/2 in.)

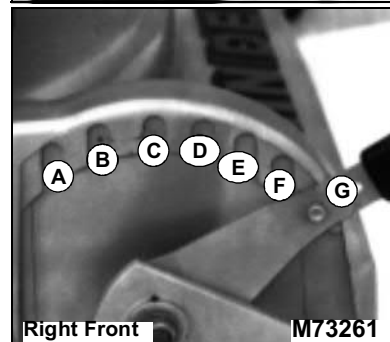
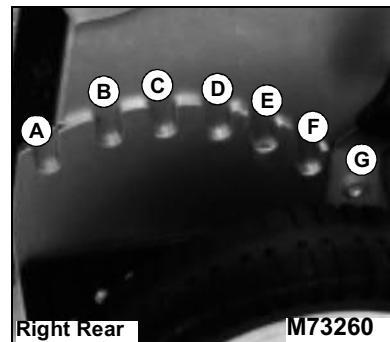

OPERATING

Adjusting Handle Height

1. Remove knob (A) and bolt from each side.
2. Move handle to desired height.

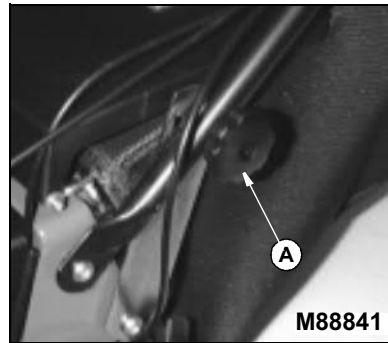

NOTE: Rear grass bag removed to illustrate photo clarity.

3. Move bracket (B) so a square hole in bracket lines up with handle hole.
4. Install carriage bolt (C) through same square hole on each side.
5. Install and tighten knobs.

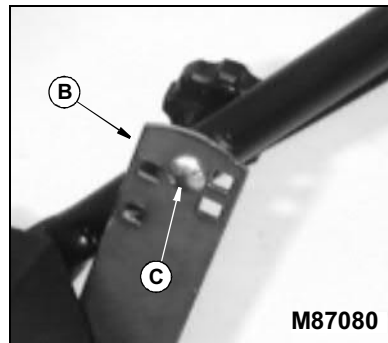

Using Fuel Shutoff

Turn the fuel shutoff knob so pointer (A) is toward the OPEN position when operating mower.

Turn the fuel shutoff knob (A) so pointer is toward the CLOSED position when you are not operating mower.

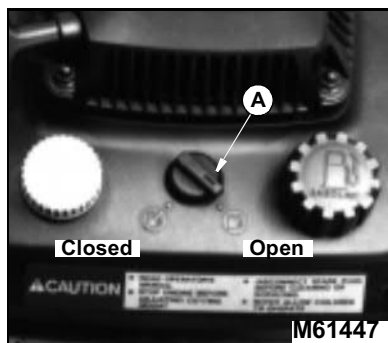

OPERATING

Electric Starting (JE75)



CAUTION: To avoid injury from cutting blades:



Keep hands and feet away.

Do not put hands or feet under or into mower when engine is running.





Engine exhaust fumes can cause sickness or death.

Run engine only in a ventilated area.

IMPORTANT: To help prevent damage to starter and/or blade brake clutch, do not start engine when blade is under load, such as in heavy grass.

1. Move throttle lever (A):

- COLD ENGINE: Push throttle lever (A) to the CHOKE  position.
- WARM ENGINE: Push throttle lever to the FAST  position.

NOTE: If battery is low:

- Start engine with recoil starter.
- Charge battery.

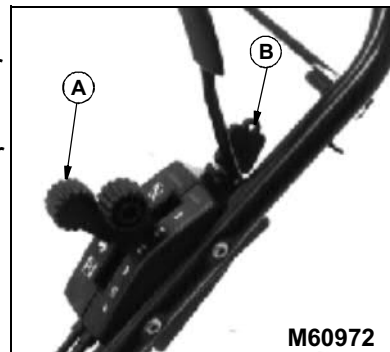

2. Turn key (B) to the START position:

- Crank engine 5 seconds.
- If engine does not start, wait 10 seconds.
- Crank engine again 5 seconds.
- Repeat this procedure if necessary.

3. Release key when engine starts.

4. Pull throttle lever back to the HALF-THROTTLE position.

5. Mow with throttle lever in the FAST  position.



Suggest:

If the above button click is invalid.

Please download this document



first, and then click the above link

to download the complete manual.

Thank you so much for reading



OPERATING

Manual Starting

	CAUTION:	To avoid injury from cutting blades:
		Keep hands and feet away.
		Do not put hands or feet under or into mower when engine is running.
		Engine exhaust fumes can cause sickness or death.
		Run engine only in a ventilated area.

IMPORTANT: To help prevent damage to recoil starter and/or blade brake clutch, do not start engine when blade is under load, such as in heavy grass.

NOTE: Follow steps listed below on the JE75 if battery power is too low to crank engine.

1. Move throttle lever (A):
 - COLD ENGINE: Push throttle lever (A) to the CHOKE  position.
 - WARM ENGINE: Push throttle lever to the FAST  position.

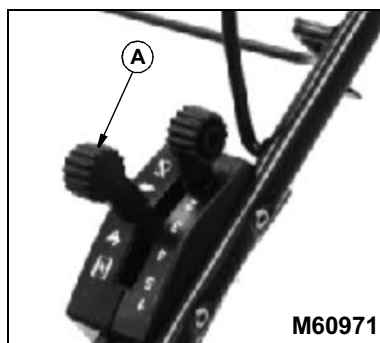

2. Put your foot on foot pad on top, left side of deck.
3. Pull starter handle until you feel resistance. Then pull fast and steady.
4. When engine starts, return rope slowly.
5. Pull throttle lever back to the HALF-THROTTLE position.
6. Mow with throttle lever in the FAST  position.

<https://www.ebooklibonline.com>

Hello dear friend!

Thank you very much for reading.

Enter the link into your browser.

The full manual is available for immediate download.

<https://www.ebooklibonline.com>