

**JOHN DEERE**  
**WORLDWIDE COMMERCIAL & CONSUMER**  
**EQUIPMENT DIVISION**

---

---

**21-Inch Walk-Behind Rotary Mowers**  
**JS61 and JS63**

OMGC00667 C1

**OPERATOR'S MANUAL**



**JOHN DEERE**

North American Version  
Litho in U.S.A.

# INTRODUCTION

---

## Thank You for Purchasing a John Deere Product

We appreciate having you as a customer and wish you many years of safe and satisfied use of your machine.

## Using Your Operator's Manual

This manual is an important part of your machine and should remain with the machine when you sell it.

Reading your operator's manual will help you and others avoid personal injury or damage to the machine. Information given in this manual will provide the operator with the safest and most effective use of the machine. Knowing how to operate this machine safely and correctly will allow you to train others who may operate this machine.

This manual and safety signs on your machine may also be available in other languages (see your John Deere dealer to order).

Sections in your operator's manual are placed in a specific order to help you understand all the safety messages and learn the controls so you can operate this machine safely. You can also use this manual to answer any specific operating or servicing questions. A convenient index located at the end of this book will help you to find needed information quickly.

The machine shown in this manual may differ slightly from your machine, but will be similar enough to help you understand our instructions.

RIGHT-HAND and LEFT-HAND sides are determined by facing in the direction the machine will travel when going forward. When you see a broken line arrow (----->), the item referred to is hidden from view.

Before delivering this machine, your dealer performed a predelivery inspection to ensure best performance.

## Special Messages

Your manual contains special messages to bring attention to potential safety concerns, machine damage as well as helpful operating and servicing information. Please read all the information carefully to avoid injury and machine damage.

**IMPORTANT:** Avoid damage! This text is used to tell the operator of actions or conditions that might result in damage to the machine.

**NOTE:** General information is given throughout the manual that may help the operator in the operation or service of the machine.

## CALIFORNIA Proposition 65 Warning

**Warning:** The Engine Exhaust from this product contains chemicals known to the State of California to cause cancer, birth defects or other reproductive harm.



**CAUTION:** Avoid injury! This symbol and text highlight potential hazards or death to the operator or bystanders that may occur if the hazards or procedures are ignored.

# PRODUCT IDENTIFICATION

---

## Record Identification Numbers

### 21-Inch Walk-Behind Rotary Mowers

#### JS61 and JS63 PIN (100001-)

If you need to contact an Authorized Service Center for information on servicing, always provide the product model and serial number.

You will need to locate the model and serial number for the machine and for the engine of your machine and record the information in the spaces provided below.

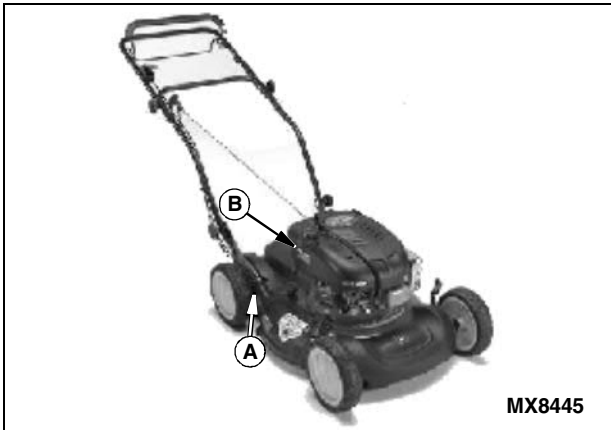

DATE OF PURCHASE:

---

DEALER NAME:

---

DEALER PHONE:

---

PRODUCT IDENTIFICATION NUMBER (A):

---

ENGINE SERIAL NUMBER (B):

---

**<https://www.ebooklibonline.com>**

Hello dear friend!

Thank you very much for reading.

Enter the link into your browser.

The full manual is available for immediate download.

**<https://www.ebooklibonline.com>**

# TABLE OF CONTENTS

---

Safety .....	1
Operating.....	6
Replacement Parts.....	12
Service Intervals.....	13
Service .....	14
Troubleshooting .....	24
Storing Machine.....	26
Assembly .....	28
Specifications .....	30
Warranty .....	32
Index.....	36

All information, illustrations and specifications in this manual are based on the latest information at the time of publication. The right is reserved to make changes at any time without notice.

COPYRIGHT© 2001  
Deere & Co.

John Deere Worldwide Commercial and  
Consumer Equipment Division

All rights reserved  
Previous Editions  
COPYRIGHT© 1999, 1998, 1997

OMGC00667 C1 - English

# SAFETY

## Understanding The Machine Safety Labels



The machine safety labels shown in this section are placed in important areas on your machine to draw attention to potential safety hazards.

On your machine safety labels, the words DANGER, WARNING, and CAUTION are used with this safety-alert symbol, (▲). DANGER identifies the most serious hazards.

The operator's manual also explains any potential safety hazards whenever necessary in special safety messages that are identified with the word, CAUTION, and the safety-alert symbol, (▲).

## WARNING: AVOID SERIOUS INJURY OR DEATH



- Read the Owner's Manual.
- Go across slopes, not up and down.
- Do not mow when children or others are around.
- Look down and behind before and while mowing backwards.
- Remove objects that could be thrown by the blade.
- Keep safety devices in place and working.

## DANGER:



KEEP HANDS AND FEET AWAY from CUTTING BLADES

## DANGER:



To avoid injury, do not operate mower without protective mulch guard, side discharge chute or grass bagging system fastened in place.

# SAFETY

## DANGER



## CAUTION



### ROTATING BLADE

- Stop engine before opening safety door and clearing bagging chute.

### THROWN OBJECTS

- Do not operate mower without protective guard, side discharge chute, or complete bagging system fastened in place.

## DANGER: ROTATING BLADE



Do not put hands or feet under or into mower when engine is running

- Bag is subject to wear deterioration.
- Check bag frequently, replace when necessary.
- Use John Deere bag or equivalent to comply with safety specifications.

## Emission Control System Certification Label (Small Off-Road Gas Engines)

**NOTE:** *Tampering with emission controls and components by unauthorized personnel may result in severe fines or penalties. Emission controls and components can only be adjusted by EPA and/or CARB authorized service centers. Contact your John Deere Commercial and Consumer Equipment Retailer concerning emission controls and component questions.*

The presence of an emissions label signifies that the engine has been certified with the United States Environmental Protection Agency (EPA) and/or California Air Resources Board (CARB).

The emissions warranty applies only to those engines marketed by John Deere that have been certified by the EPA and/or CARB; and used in the United States and Canada in off-road mobile equipment.

## Emission Compliance Period (Small Off-Road Gas Engines)

If your engine has the emission compliance category listed on the emission control system certification or air index label, this indicates the number of operating hours for which the engine has been certified to meet EPA and/or

# SAFETY

CARB emission requirements. The following table provides the engine compliance period in hours associated with the category found on the certification label.

Agency	Category	Hours
EPA	C	250
EPA	B	500
EPA	A	1000
CARB	Moderate	125
CARB	Intermediate	250
CARB	Extended	500

## Certification Label

This OPEI label on your mower indicates that this model has been certified by an independent laboratory for compliance with American National Standard B-71.1, "Safety Specifications" for Power Lawn Mowers, Lawn and Garden Tractors, and Lawn Tractors.

## Operate Safely

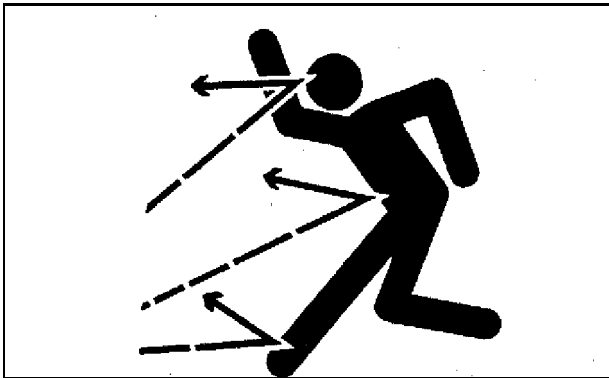

- Inspect machine before you operate. Be sure hardware is tight. Repair or replace damaged, badly worn, or missing parts. Be sure proper guards, plates, grass catcher, or other safety protective devices are in good condition and fastened in place. Make any necessary adjustments before you operate.
- Clear work area of objects that might be thrown. Keep people and pets out of the work area. Stop machine if anyone enters the area.
- If you hit an object, stop the machine and inspect it. Make repairs before you operate. Keep machine properly maintained and in good working order.

- Do not leave machine unattended when it is running.
- Only operate during daylight or with good artificial light.
- Be sure of footing. Be especially careful when you pull machine backwards with the engine running.
- Mow across a hill - not up and down. Be careful when you change direction on a slope. Do not mow excessively steep slopes.
- Do not mow wet grass. Reduced traction could cause you to slip.
- Keep a firm hold on the machine handle.
- Do not wear radio or music headphones while operating the machine. Safe operation requires your full attention.
- Do not operate mower if you are under the influence of drugs or alcohol.

## Rotating Blades are Dangerous - Protect Children and Prevent Accidents

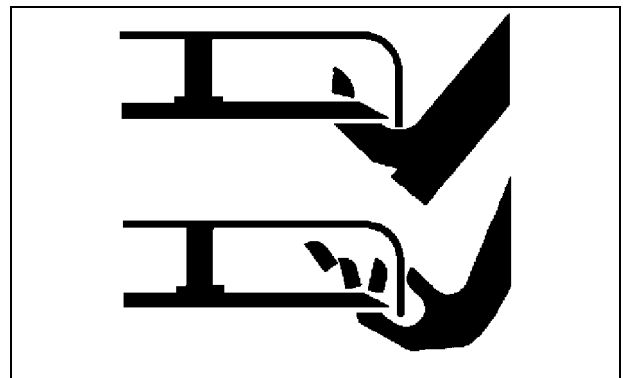
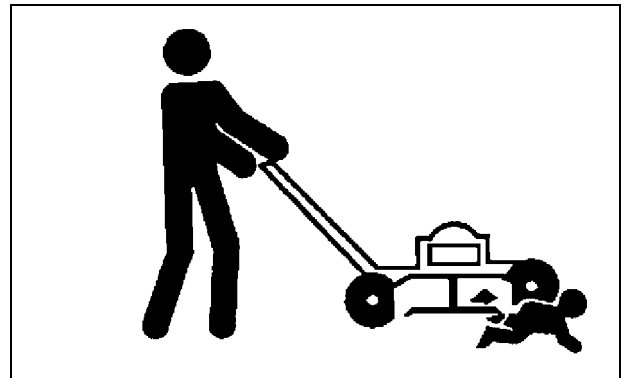

### Protect Children:

- Never assume that children will remain where you last saw them. Children are attracted to mowing activity, stay alert to the presence of children.
- Keep children in the house when you are operating the machine.
- Turn machine off if a child enters the area.

# SAFETY

---

- Use extra care when you come to blind corners, shrubs, trees, or other objects that may block your vision.
- Do not let children or an untrained person operate the machine.

## Help Prevent Serious Or Fatal Accidents:

- Be alert at all times, people especially children can move quickly into the area before you know it.
- Stop the blade when crossing gravel drives, walks, or roads.
- Shut off blades when you are not mowing.
- Keep hands, feet, and clothing away from rotating blades.

## Wear Appropriate Clothing

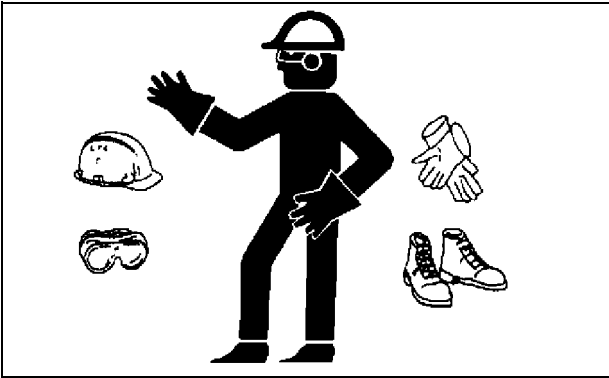

- Wear close fitting clothing and safety equipment appropriate for the job.
- Do not operate the equipment when barefoot or wearing open sandals. Always wear substantial footwear.
- Loud noise can cause impairment or loss of hearing, wear a suitable protective device such as earplugs.

## Practice Safe Maintenance



- Understand service procedure before doing work. Keep area clean and dry.
- Never lubricate, service, or adjust machine while it is moving. Keep safety devices in place and in working condition. Keep hardware tight.
- To prevent them from getting caught, keep hands, feet, clothing, jewelry, and long hair away from any moving parts.
- Before servicing machine, disengage all power and stop the engine. Let engine cool.
- Securely support any machine elements that must be raised for service work.
- Keep all parts in good condition and properly installed. Fix damage immediately. Replace worn or broken parts. Remove any buildup of grease, oil, or debris.
- Unauthorized modifications to the machine may impair its function and safety.

## Avoid Injury from Contacting Blade

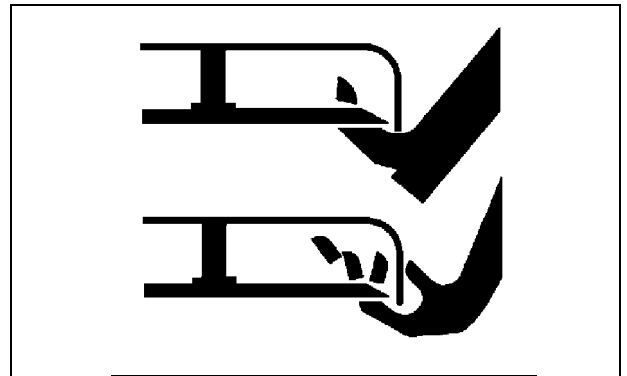

## Before you unplug or adjust machine:

- Stop the engine.
- Wait for blade to stop.
- Keep hands, feet and clothing away from blade when engine is running.

# SAFETY

## Handling Waste Products

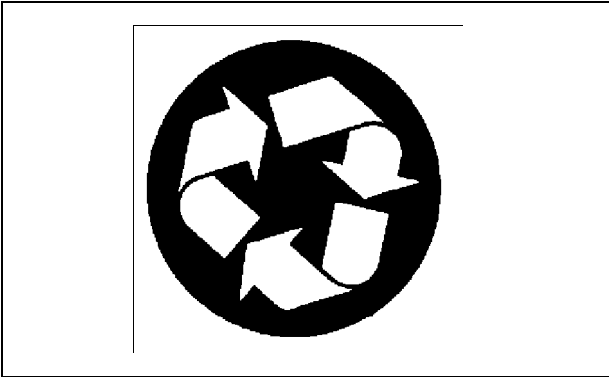

- Waste products, such as, used oil, fuel, and batteries, can harm the environment and people.
- Do not use beverage containers for waste fluids - someone may drink from them.
- See your local Recycling Center or John Deere dealer to learn how to recycle or get rid of waste products.
- A Material Safety Data Sheet (MSDS) provides specific details on chemical products: physical and health hazards, safety procedures, and emergency response techniques. See your John Deere dealer for the MSDS on chemical products used with your machine.

## Handling Fuel Safely

Fuel and fuel vapors are highly flammable:

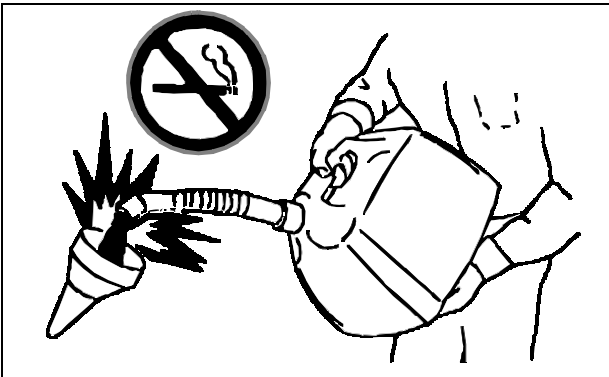

- Do not refuel machine while you smoke, when machine is near an open flame or sparks, or when engine is running. Stop engine.
- Fill fuel tank outdoors.
- Prevent fires: clean oil, grease and dirt from machine. Clean up spilled fuel immediately.
- Do not store machine with fuel in tank in a building where fumes may reach an open flame or spark.
- Prevent fire and explosion caused by static electric

discharge. Use only non-metal, portable fuel containers approved by the Underwriter's Laboratory (U.L.) or the American Society for Testing & Materials (ASTM). If using a funnel, make sure it is plastic and has no screen or filter.

- Static electric discharge can ignite gasoline vapors in an ungrounded fuel container. Remove the fuel container from the bed of a vehicle or the trunk of a car and place on the ground away from the vehicle before filling. Keep nozzle in contact with container opening while filling.



- When practical, remove equipment from trailers or truck beds and refuel them on the ground. If this is not possible, use a portable, plastic fuel container to refuel equipment on a truck bed or trailer.
- Do not use methanol gasoline. Methanol is harmful to the environment and to your health.

# OPERATING

## Engine Controls

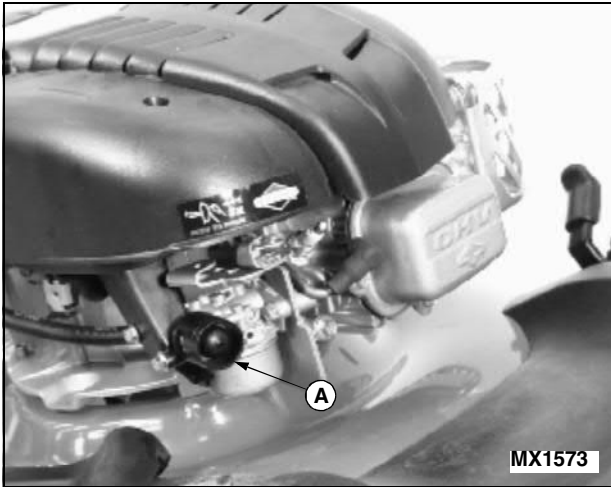

A - Primer Bulb

## Handle Controls

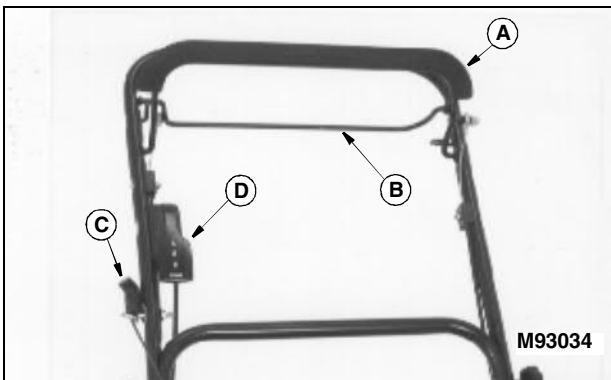

- A - Blade Control Lever
- B - Traction Clutch Lever
- C - Starter Handle
- D - Travel Speed Lever (JS63)

## Handle and Cutting Height Controls



- A - Fold Handle Knobs
- B - Handle Height Knob
- C - Cutting Height Levers

## Adjusting Handle Height

**NOTE:** Handle height can be independently adjusted to three positions.

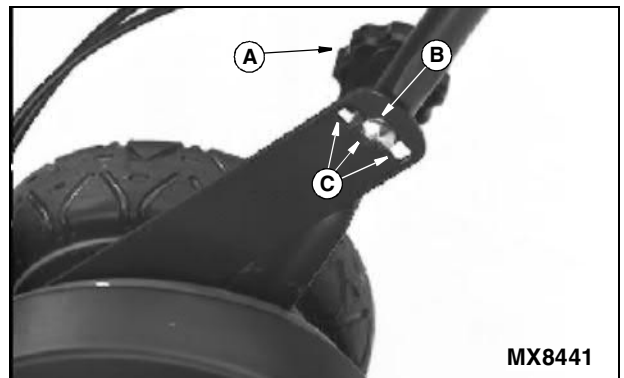

1. Remove knob (A) and bolt (B) on each side of handle.

# OPERATING

**NOTE:** If unit is equipped with bagger, bag may prevent lowering of handle.

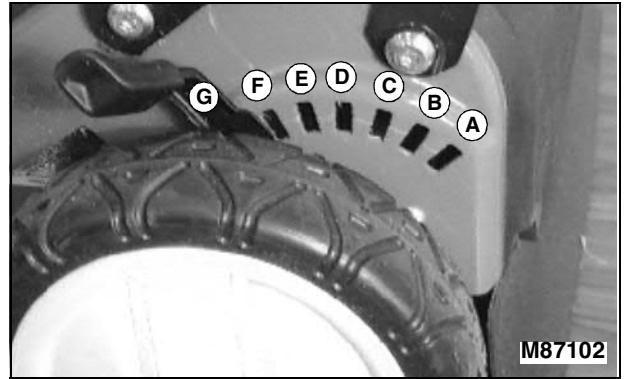
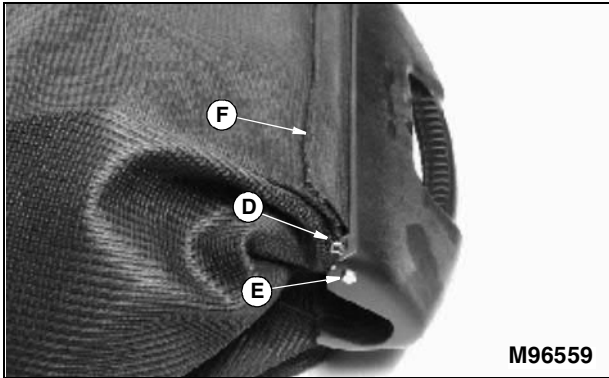

Picture Note: Left rear shown above.

2. Adjust bagger, if necessary, by removing clip (D) to remove rod (E). Remove rod from lower position (F) and insert in upper position as shown to lengthen bag.
3. Pivot handle to a desired height (C).
4. Install bolt (B) and knob (A) on each side of handle.

## Adjusting Cutting Height



**CAUTION:** Avoid injury! Rotating blades are dangerous. Before you adjust cutting height: Stop engine and wait for moving parts to stop.

**NOTE:** Adjust both levers to same height except for two lowest cutting heights (A and B on following chart). At two lowest cutting heights, raise rear lever one notch higher than front lever. This adjustment allows for increased air flow when bagging and side discharging, and provides a larger exit window for clippings when mulching.

Begin at upper cutting height, then adjust downward as desired, to avoid scalping lawn with too low a setting.

Key	Cutting Height Adjustments In mm (Inches)
(A)	25 mm (1 in.)
(B)	38 mm (1-1/2 in.)
(C)	50 mm (2 in.)
(D)	64 mm (2-1/2 in.)
(E)	75 mm (3 in.)
(F)	90 mm (3-1/2 in.)
(G)	102 mm (4 in.)

### To help move rear wheel lever:

1. Lift lower handlebar slightly with one hand to take some weight off wheel.
2. Move height adjustment lever to desired position with other hand.

## Testing Safety Systems



Picture Note: Left front shown above.

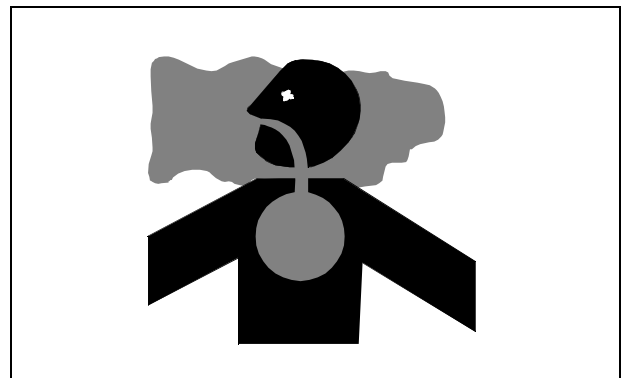

# OPERATING



**CAUTION: Avoid injury!** Engine exhaust fumes contain carbon monoxide and can cause serious illness or death.

Move the vehicle to an outside area before running the engine.

Do not run an engine in an enclosed area without adequate ventilation.

- Connect a pipe extension to the engine exhaust pipe to direct the exhaust fumes out of the area.
- Allow fresh outside air into the work area to clear the exhaust fumes out.

Use the following checkout procedure to check for normal operation of machine.

If there is a malfunction during one of these procedures, do not operate machine. **See your John Deere dealer for service.**

Perform these tests in a clear open area. Keep bystanders away.

## Testing Blade/Engine Control Lever

1. Start engine.
2. Release blade/engine control lever.
3. Listen for blade and engine to stop. Do not look under mower to check blade.

**Result:** Blade and engine should stop within three seconds. If blade and engine continue to run, there is a problem with your safety interlock circuit.

## Starting Engine



**CAUTION: Avoid injury!** Engine exhaust fumes can cause sickness or death.

Run engine only in a ventilated area.

If engine is run in an enclosed area, open doors to bring in outside air.

**IMPORTANT: Avoid damage!** To help prevent damage to recoil starter and band brake, do not start engine:

- When blade is under load, such as, in heavy grass.
- When blade control lever is released.

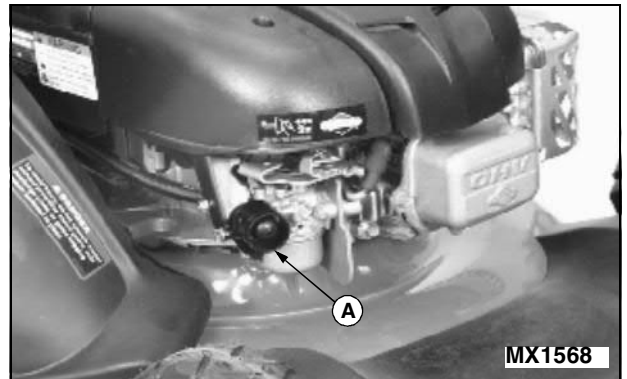

1. Prime engine by pressing primer bulb (A):
  - COLD Engine - 3 times
  - WARM Engine - if engine does not start on first or second pull, press primer bulb 1 or 2 times



**CAUTION: Avoid injury!** When engine is running, blade is turning.

Keep hands, feet and clothing away from the blade.

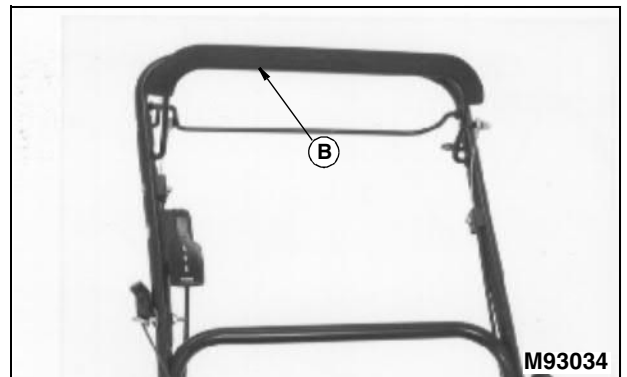

2. Hold blade control lever (B) against handle.

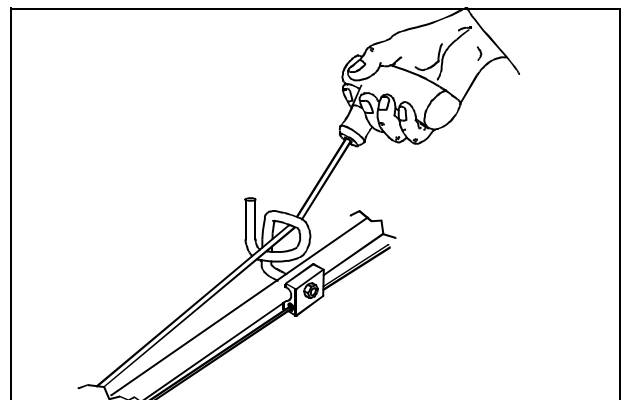

3. Pull starter handle until you feel resistance. Then pull fast and steady.

# OPERATING

4. When engine starts, return rope slowly.

## Forward Travel

### To Travel Forward

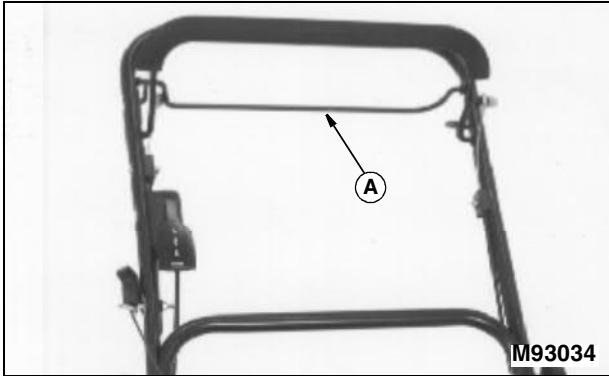

Pull and hold traction clutch lever (A) against upper handle.

### To Stop Forward Travel

**NOTE:** Rear wheels will make a clicking noise when mower is pushed forward. This indicates that the drive train is operating correctly.

Release lever (A). Release traction clutch lever before turning the mower.

## Travel Speeds

### Travel speed: (JS61)

- 1st Gear: 3.9 km/h (2.4 mph)

### Travel speeds: (JS63)

- 1st Gear: 3.1 km/h (1.9 mph)
- 2nd Gear: 3.9 km/h (2.4 mph)
- 3rd Gear: 5.0 km/h (3.1 mph)

### To change travel speeds: (JS63)

**NOTE:** Mower travel speed can be changed when the traction clutch lever is engaged and the mower is moving forward.

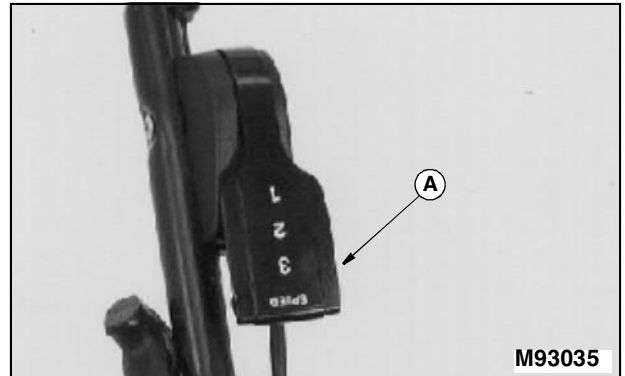

- Raise or lower speed control lever (A) to engage desired gear.

## Stopping Engine

### Release handle and levers:

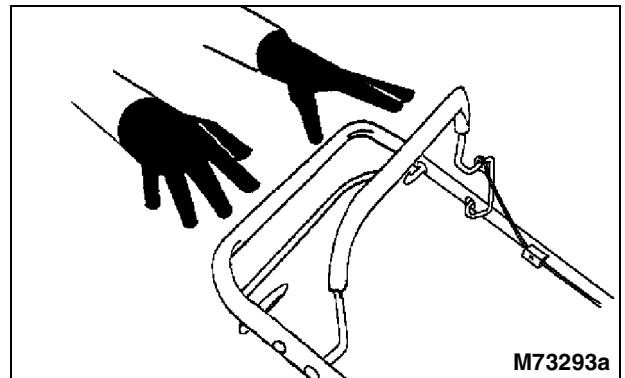

- Mower will stop.
- Blade will stop.
- Engine will stop.

**IMPORTANT:** Avoid damage! If blade does not stop within 3 seconds after you release blade stop lever, see your John Deere dealer

## Using Side Discharge Chute



**CAUTION:** Avoid injury! Do not operate mower unless grass bag assembly, side discharge chute or mulch guard is in place.



**Suggest:**

**If the above button click is invalid.**

**Please download this document**

**first, and then click the above link**

**to download the complete manual.**

**Thank you so much for reading**

# OPERATING

1. Release blade control lever to stop engine.

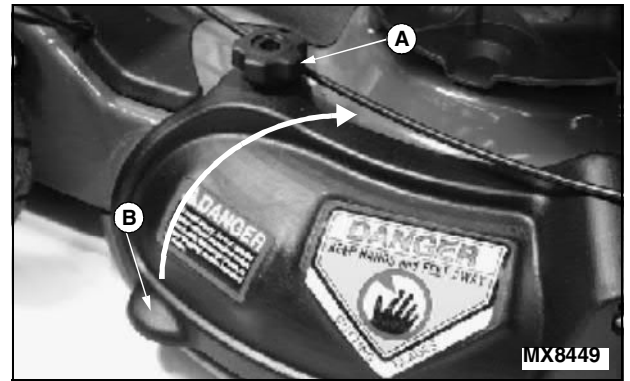

2. Remove mulch guard knob (A).

1. Remove mulch guard knob (A).
2. Lift and hold spring loaded mulch guard (B) up.
3. Install bagging chute:

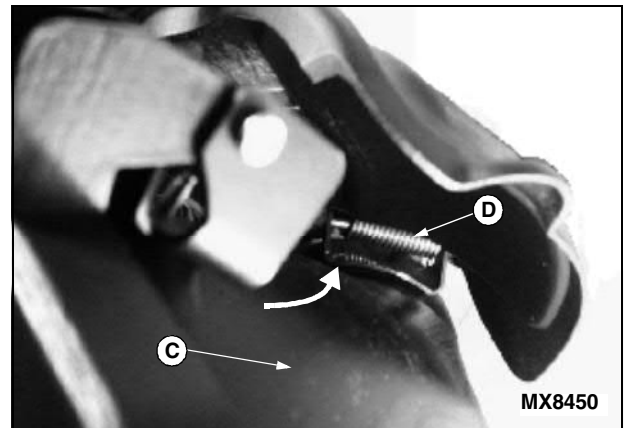
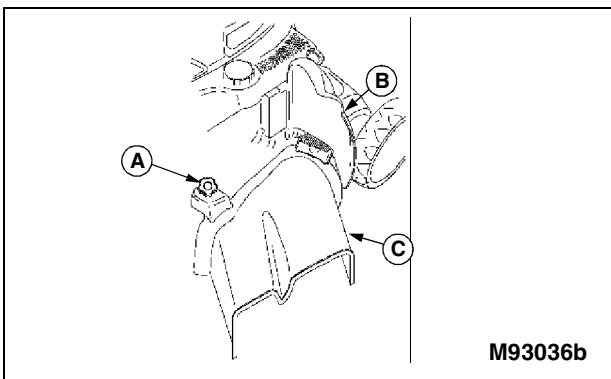

3. Lift and hold spring loaded mulch guard (B) up.
4. Install side discharge chute (C):

- a. Slide bagging chute (C) into position under the mulch guard mounting bracket (D).

- Slide side discharge chute under mulch guard mounting bracket.
- Lower mulch guard.
- Install and tighten knob (A).



- b. Lower bagging chute over stud. Install and tighten knob (E).

## Installing Grass Bag



**CAUTION: Avoid injury! Do not operate mower unless mulch guard, side discharge chute or grass bag and bagging chute are in place.**

**Bagging chute must be removed and mulch guard secured in place when grass bag is not being used.**

**<https://www.ebooklibonline.com>**

Hello dear friend!

Thank you very much for reading.

Enter the link into your browser.

The full manual is available for immediate download.

**<https://www.ebooklibonline.com>**