

JOHN DEERE
WORLDWIDE COMMERCIAL & CONSUMER
EQUIPMENT DIVISION

21-Inch Walk-Behind Rotary Mowers
JS60, JS61, and JS63

OPERATOR'S MANUAL



OMGC00397 B0

North American Version
Litho in U.S.A.

INTRODUCTION

Thank You for Purchasing a John Deere Product

We appreciate your business and wish you many years of safe and satisfied use of your machine.

Using Your Operator's Manual

This manual is an important part of your machine and should remain with the machine when you sell it.

Reading your operator's manual will help you and others avoid personal injury or damage to the machine. Information given in this manual will provide the operator with the safest and most effective use of the machine. Knowing how to operate this machine safely and correctly will allow you to train others who may operate this machine.

Sections in your operator's manual are placed in a specific order to help you understand all the safety messages and learn the controls so you can operate this machine safely. You can also use this manual to answer any specific operating or servicing questions. A convenient index located at the end of this book will help you to find needed information quickly.

The machine shown in this manual may differ slightly from your machine, but will be similar enough to help you understand our instructions.

RIGHT-HAND and LEFT-HAND sides are determined by facing in the direction the machine will travel when going forward. When you see a broken line arrow (----->), the item referred to is hidden from view.

Special Messages

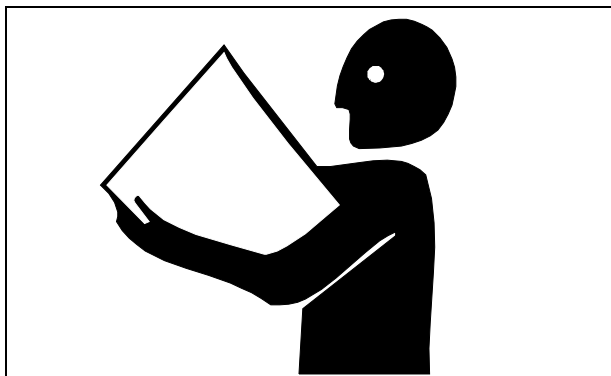

Your manual contains special messages to bring attention to potential safety concerns, machine damage as well as helpful operating and servicing information. Please read all the highlighted information carefully to avoid injury and machine damage.



CAUTION: Avoid injury!

This symbol and text highlight potential hazards or death to the operator or bystanders may occur if the hazards or procedures are ignored.

IMPORTANT: Avoid damage! This text is used to tell the operator of actions or conditions that might result in damage to the machine.

NOTE: General information is given throughout the manual that may help the operator in the operation of the machine.

CALIFORNIA Proposition 65 Warning



Warning: The Engine Exhaust from this product contains chemicals known to the State of California to cause cancer, birth defects or other reproductive harm.

PRODUCT IDENTIFICATION

Record Identification Numbers

21-Inch Walk-Behind Rotary Mowers

JS60, JS61, and JS63 PIN (010001-)

If you need to contact an Authorized Service Center for information on servicing, always provide the product model and serial number.

You will need to locate the model and serial number for the machine and for the engine of your machine and record the information in the spaces provided below.

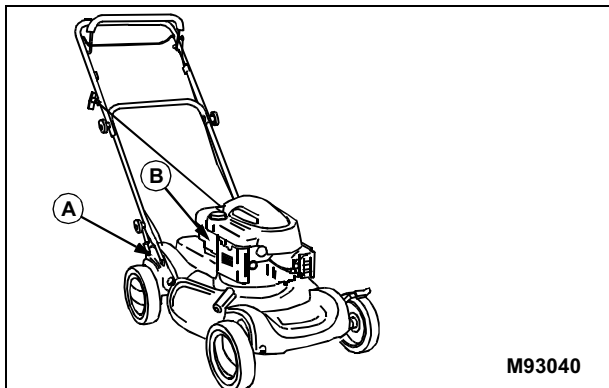

DATE OF PURCHASE:

DEALER NAME:

DEALER PHONE:

PRODUCT IDENTIFICATION NUMBER (A):

ENGINE SERIAL NUMBER (B):

<https://www.ebooklibonline.com>

Hello dear friend!

Thank you very much for reading.

Enter the link into your browser.

The full manual is available for immediate download.

<https://www.ebooklibonline.com>

TABLE OF CONTENTS

Safety	1
Operating	5
Replacement Parts	12
Service Intervals	13
Service	14
Troubleshooting	25
Storing Machine.....	27
Assembly	29
Specifications	33
Warranty	35
Index.....	37

All information, illustrations and specifications in this manual are based on the latest information at the time of publication. The right is reserved to make changes at any time without notice.

COPYRIGHT© 2000
Deere & Co.
John Deere Worldwide Commercial and
Consumer Equipment Division
Horicon, WI
All rights reserved
Previous Editions
COPYRIGHT©

OMGC00397 B0 - English

SAFETY

Safety-Alert Symbol

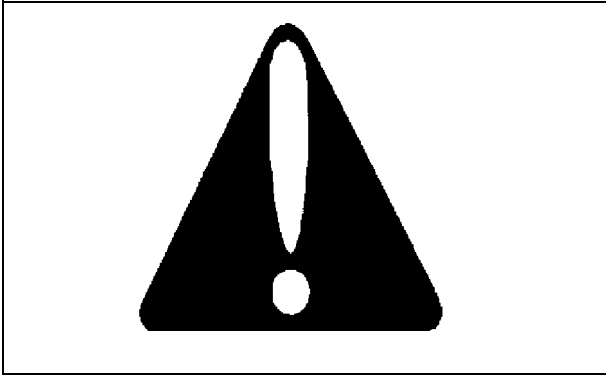

Read and recognize safety information. Be alert to the potential for personal injury when you see this safety-alert symbol.

On your machine safety labels, the words DANGER, WARNING, and CAUTION are used with this safety-alert symbol. DANGER identifies the most serious hazards. In this manual, the word CAUTION and this symbol call attention to safety messages.

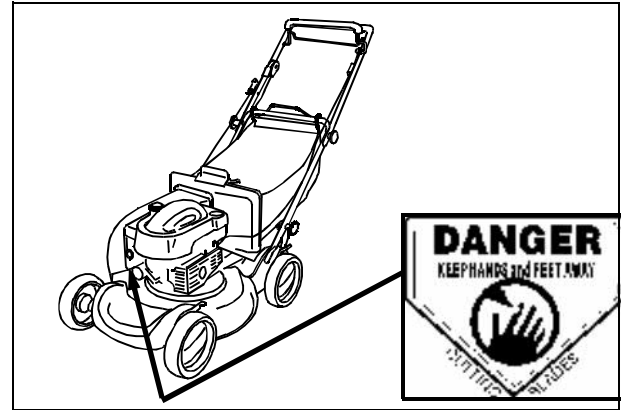

DANGER: KEEP HANDS AND FEET AWAY FROM CUTTING BLADES

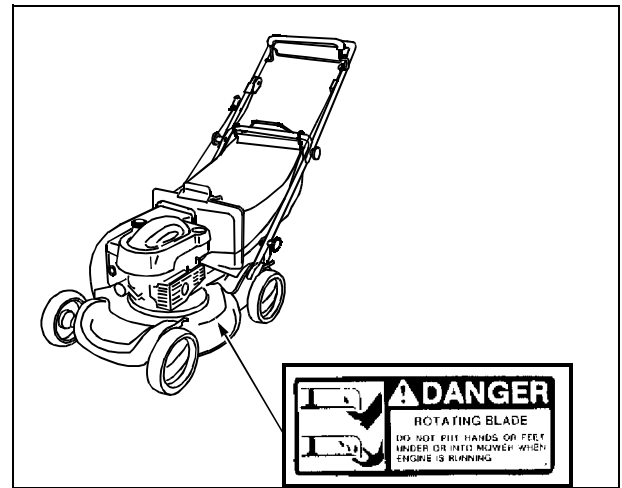

DANGER: ROTATING BLADE

DO NOT PUT HANDS OR FEET UNDER OR INTO MOWER WHEN ENGINE IS RUNNING

Machine Safety Labels

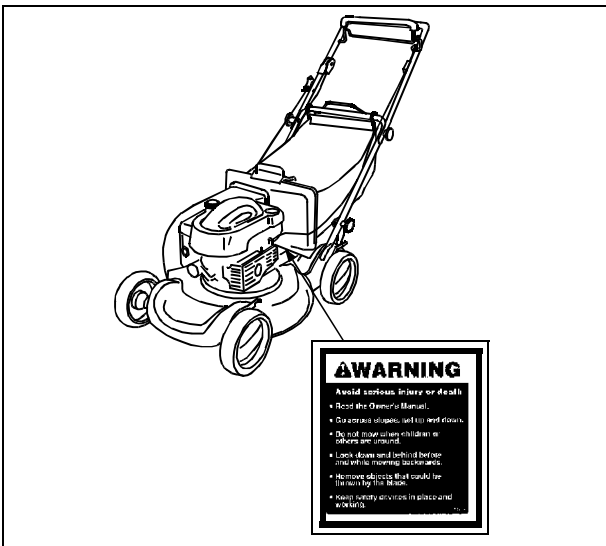

WARNING: AVOID SERIOUS INJURY OR DEATH

- Read the Owner's Manual.
- Go across slopes, not up and down.
- Do not mow when children or others are around.
- Look down and behind before and while mowing backwards.
- Remove objects that could be thrown by the blade.
- Keep safety devices in place and working.

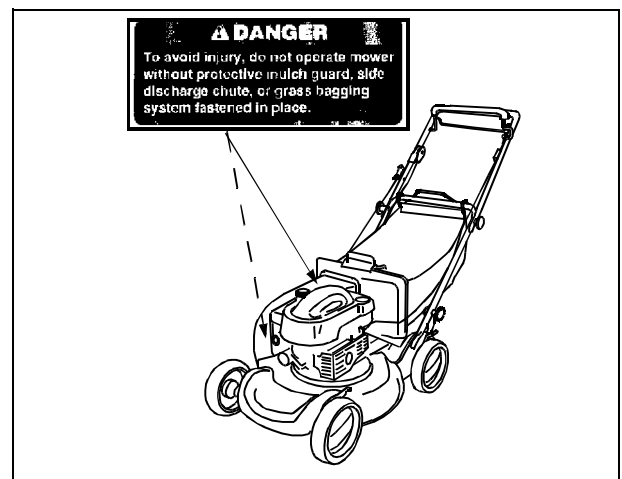

DANGER:

To avoid injury, do not operate mower without protective

SAFETY

mulch guard, side discharge chute or grass bagging system fastened in place.

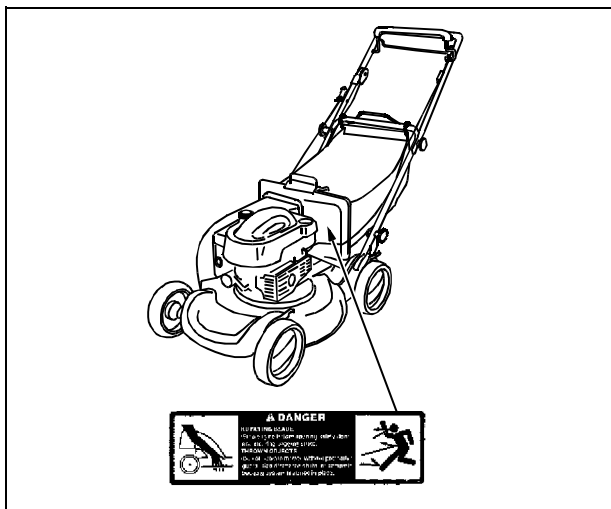

DANGER: ROTATING BLADE

- Stop engine before opening safety door and clearing bagging chute.

THROWN OBJECTS

- Do not operate mower without protective guard, side discharge chute, or complete bagging system fastened in place.

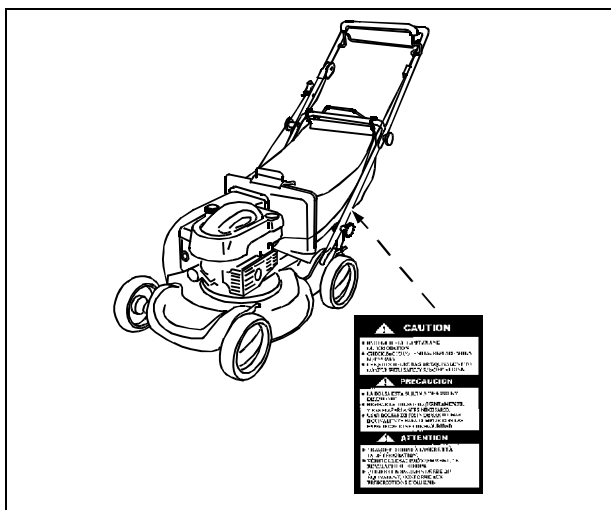

CAUTION

- Bag is subject to wear deterioration.
- Check bag frequently, replace when necessary.
- Use John Deere bag or equivalent to comply with safety specifications.

Certification Label

This OPEI label on your mower indicates that this model has been certified by an independent laboratory for compliance with American National Standard B-71.1, "Safety Specifications" for Power Lawn Mowers, Lawn and Garden Tractors, and Lawn Tractors.

SAFETY

Operate Safely

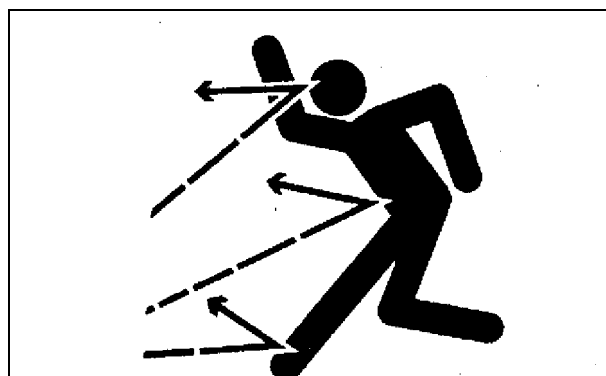

- Inspect machine before you operate. Be sure hardware is tight. Repair or replace damaged, badly worn, or missing parts. Be sure proper guards, plates, grass catcher, or other safety protective devices are in good condition and fastened in place. Make any necessary adjustments before you operate.
- Clear work area of objects that might be thrown. Keep people and pets out of the work area. Stop machine if anyone enters the area.
- If you hit an object, stop the machine and inspect it. Make repairs before you operate. Keep machine properly maintained and in good working order.
- DO NOT leave machine unattended when it is running.
- Only operate during daylight or with good artificial light.
- Be sure of footing. Be especially careful when you pull machine backwards with the engine running.
- Mow across a hill - not up and down. Be careful when you change direction on a slope. DO NOT mow excessively steep slopes.
- DO NOT mow wet grass. Reduced traction could cause you to slip.
- Keep a firm hold on the machine handle.
- DO NOT wear radio or music headphones while operating the machine. Safe operation requires your full attention.
- DO NOT operate mower if you are under the influence of

SAFETY

drugs or alcohol.

Rotating Blades are Dangerous - Protect Children and Prevent Accidents

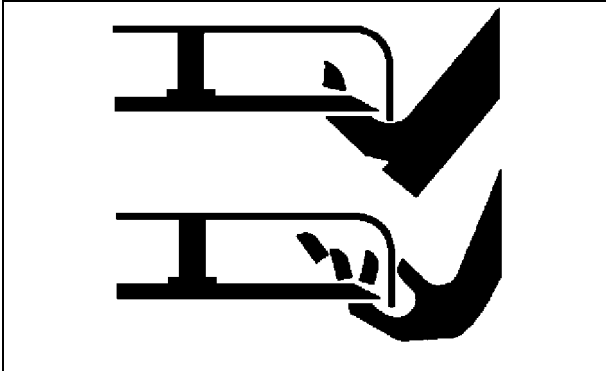

PROTECT CHILDREN:

- Never assume that children will remain where you last saw them. Children are attracted to mowing activity, stay alert to the presence of children.
- Keep children in the house when you are operating the machine.
- Turn machine off if a child enters the area.
- Use extra care when you come to blind corners, shrubs, trees, or other objects that may block your vision.
- DO NOT let children or an untrained person operate the machine.

HELP PREVENT SERIOUS OR FATAL ACCIDENTS:

- Be alert at all times, people especially children can move quickly into the area before you know it.
- Stop the blade when crossing gravel drives, walks, or roads.
- Shut off blades when you are not mowing.
- Keep hands, feet, and clothing away from rotating blades.

Wear Appropriate Clothing

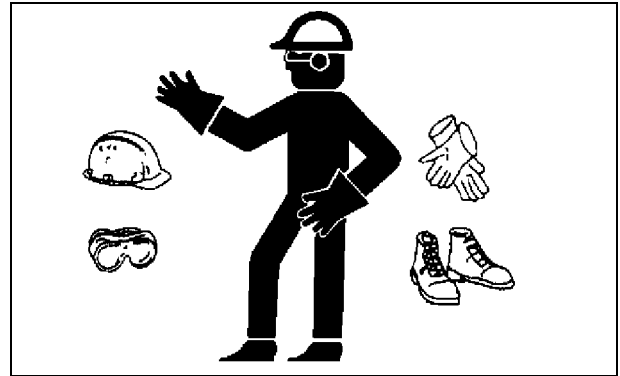

- Wear close fitting clothing and safety equipment appropriate for the job.
- Do Not operate the equipment when barefoot or wearing open sandals. Always wear substantial footwear.
- Loud noise can cause impairment or loss of hearing, wear a suitable protective device such as earplugs.

Practice Safe Maintenance



- Understand service procedure before doing work. Keep area clean and dry.
- Never lubricate, service, or adjust machine while it is moving. Keep safety devices in place and in working condition. Keep hardware tight.
- To prevent them from getting caught, keep hands, feet, clothing, jewelry, and long hair away from any moving parts.
- Before servicing machine, disengage all power and stop the engine. Let engine cool.
- Securely support any machine elements that must be raised for service work.
- Keep all parts in good condition and properly installed. Fix damage immediately. Replace worn or broken parts. Remove any buildup of grease, oil, or debris.
- Unauthorized modifications to the machine may impair

SAFETY

its function and safety.

Avoid Injury from Contacting Blade

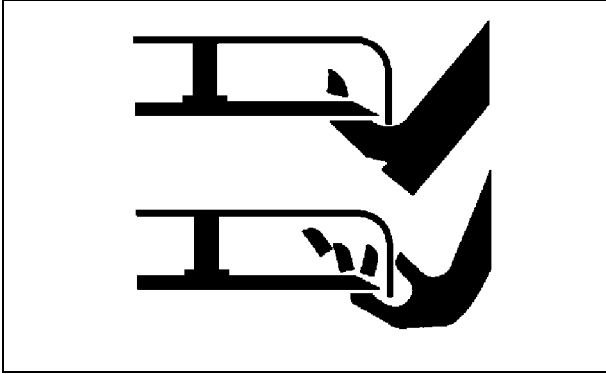

Before you unplug or adjust machine:

- STOP the engine.
- Wait for blade to STOP.
- Keep hands, feet and clothing away from blade when engine is running.

Handling Waste Products

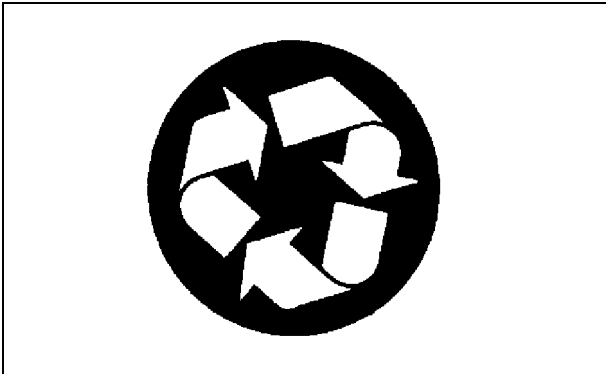

- Waste products, such as, used oil, fuel, and batteries, can harm the environment and people.
- DO NOT use beverage containers for waste fluids - someone may drink from them.
- See your local Recycling Center or John Deere dealer to learn how to recycle or get rid of waste products.
- A Material Safety Data Sheet (MSDS) provides specific details on chemical products: physical and health hazards, safety procedures, and emergency response techniques. See your John Deere dealer for the MSDS on chemical products used with your machine.

Handling Fuel Safely

Fuel and fuel vapors are highly flammable:



- DO NOT refuel machine while you smoke, when machine is near an open flame or sparks, or when engine is running. STOP engine.
- Fill fuel tank outdoors.
- Prevent fires: clean oil, grease and dirt from machine. Clean up spilled fuel immediately.
- Do not store machine with fuel in tank in a building where fumes may reach an open flame or spark.
- Prevent fire and explosion caused by static electric discharge. Use only non-metal, portable fuel containers approved by the Underwriter's Laboratory (U.L.) or the American Society for Testing & Materials (ASTM). If using a funnel, make sure it is plastic and has no screen or filter.
- Static electric discharge can ignite gasoline vapors in an ungrounded fuel container. Remove the fuel container from the bed of a vehicle or the trunk of a car and place on the ground away from the vehicle before filling. Keep nozzle in contact with container opening while filling.



- When practical, remove equipment from trailers or truck beds and refuel them on the ground. If this is not possible, use a portable, plastic fuel container to refuel equipment on a truck bed or trailer.
- DO NOT use METHANOL gasoline. METHANOL is harmful to the environment and to your health.

OPERATING

Engine Controls



A - Primer Bulb

Handle Controls

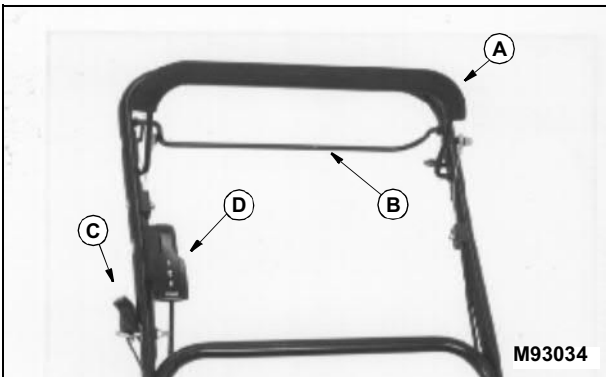

- A - Blade Control Lever
- B - Traction Clutch Lever (JS61 and JS63)
- C - Starter Handle
- D - Travel Speed Lever (JS63)

Handle and Cutting Height Controls



- A - Fold Handle Knobs
- B - Handle Height Knob
- C - Cutting Height Levers

ADJUSTMENTS

Adjusting Cutting Height



**CAUTION: Avoid injury! Before you adjust cutting height:
STOP ENGINE.**

NOTE: Adjust both levers to same height except for LOWEST cutting height (A). This adjustment improves mulching performance at lowest cutting height:

- Put front wheel levers in 25 mm (1 in.) notch: First rear notch.
- Put rear wheel levers in 38 mm (1-1/2 in.) notch: Second rear notch.

To help move rear wheel lever:

1. Lift lower handlebar slightly with one hand to take some weight off wheel.
2. Move height adjustment lever to desired position with other hand.

OPERATING



Adjusting Handle Height

Upper Handle:

NOTE: Upper handle height can be independently adjusted to two positions.

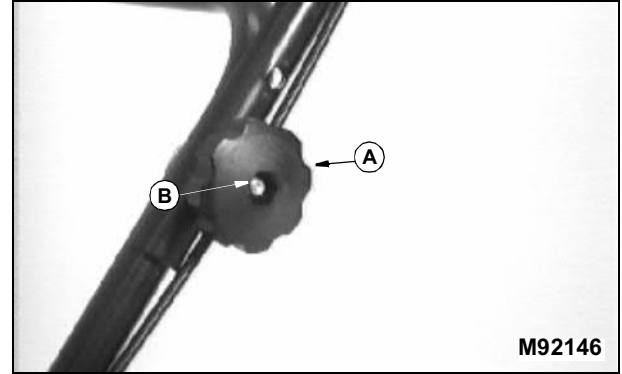

1. Remove knob (A) and bolt (B) from each side of upper handle.
2. Move handle to desired height.
3. Install bolt through matching holes in upper and lower handles on each side.
4. Install and tighten knob (A).

Lower Handle:

NOTE: Lower handle height can be independently adjusted to three positions.

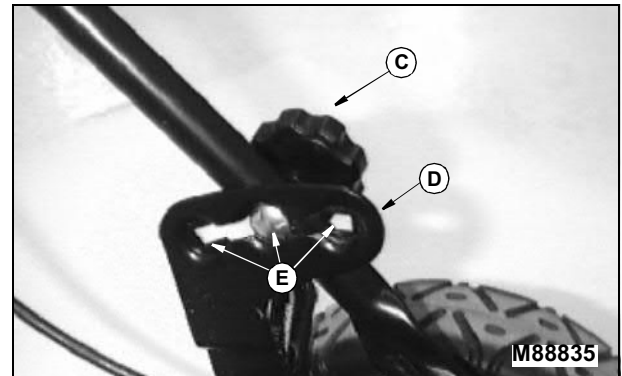

1. Loosen knob (C) approximately 25 mm (1 in.) on each side of handle.

NOTE: Carriage bolts must travel within slotted adjustment brackets and come to rest within one of the three height setting positions (E) before tightening.

2. Pivot handle to a desired height within slotted adjustment bracket (D).

Key	Cutting Height Adjustments In mm (Inches)
(A)	25 mm (1 in.)
(B)	38 mm (1-1/2 in.)
(C)	50 mm (2 in.)
(D)	64 mm (2-1/2 in.)
(E)	75 mm (3 in.)
(F)	90 mm (3-1/2 in.)
(G)	102 mm (4 in.)



OPERATING

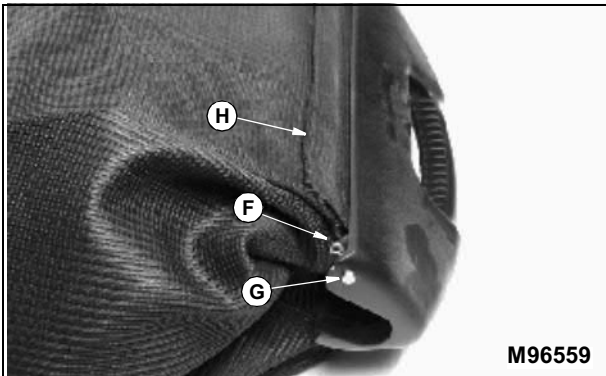

3. If bag prevents lowering of handle, remove clip (F) to remove rod (G). Remove rod from lower position (H) and insert in upper position as shown to lengthen bag.
4. Tighten knob (C) on each side of handle.

Starting Engine



CAUTION: Avoid injury! Engine exhaust fumes can cause sickness or death. Run engine only in a ventilated area.

If engine is run in an enclosed area, open doors to bring in outside air.

IMPORTANT: Avoid damage! To help prevent damage to recoil starter and band brake, do not start engine:

- When blade is under load, such as, in heavy grass.
- When blade control lever is released.

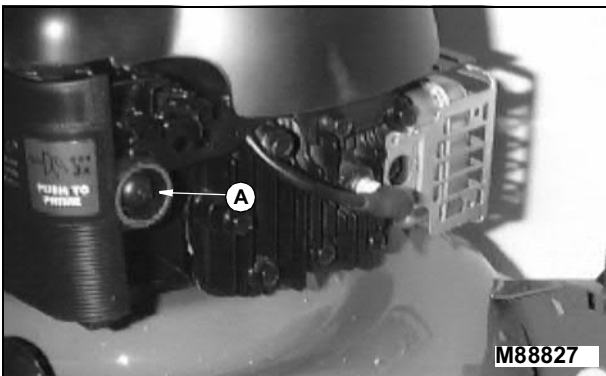

1. Prime engine by pressing primer bulb (A):
 - COLD Engine - 3 times
 - WARM Engine - 1 or 2 times



CAUTION: Avoid injury! WHEN ENGINE IS RUNNING, BLADE IS TURNING. Keep hands, feet and clothing away from the blade.

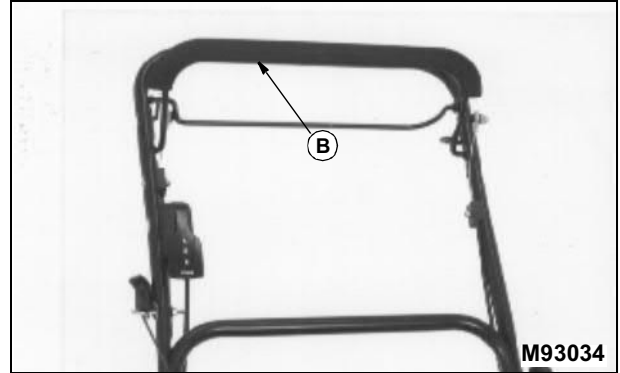

2. Hold blade control lever (B) against handle.

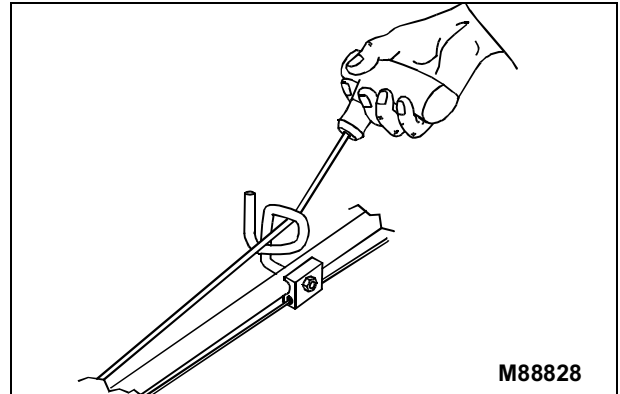

3. Pull starter handle until you feel resistance. Then pull fast and steady.
4. When engine starts, return rope slowly.

OPERATING

Forward Travel (JS61 and JS63)

To Travel Forward:

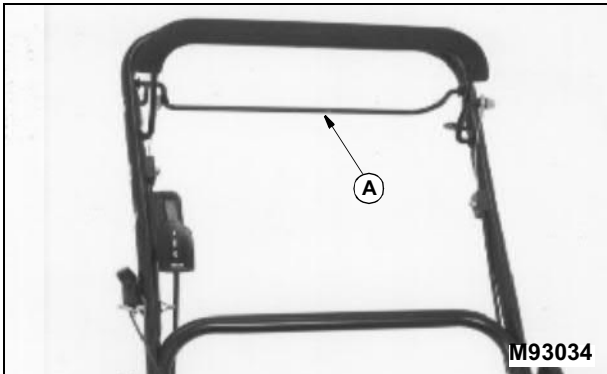

Pull and hold traction clutch lever (A) against upper handle.

To Stop Forward Travel:

NOTE: Rear wheels will make a clicking noise when mower is pushed forward. This indicates that the drive train is operating correctly.

Release lever (A). Release traction clutch lever before turning the mower.

Travel Speeds (JS61 and JS63)

Travel speed: (JS61)

- 1st Gear: 3.9 km/h (2.4 m.p.h.)

Travel speeds: (JS63)

- 1st Gear: 3.1 km/h (1.9 m.p.h.)
- 2nd Gear: 3.9 km/h (2.4 m.p.h.)
- 3rd Gear: 5.0 km/h (3.1 m.p.h.)

To change travel speeds: (JS63)

NOTE: Mower travel speed can be changed when the traction clutch lever is engaged and the mower is moving forward.

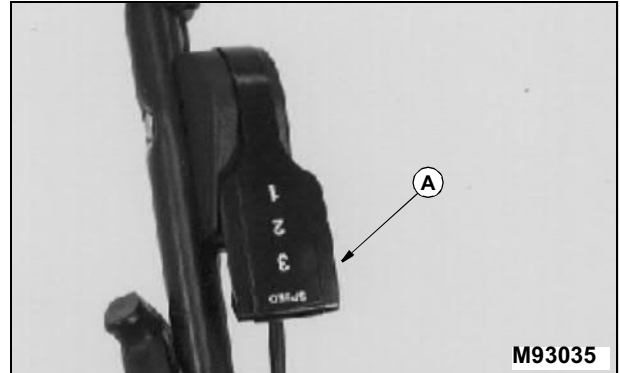

- Raise or lower speed control lever (A) to engage desired gear.

Stopping Engine

Release handle and levers:

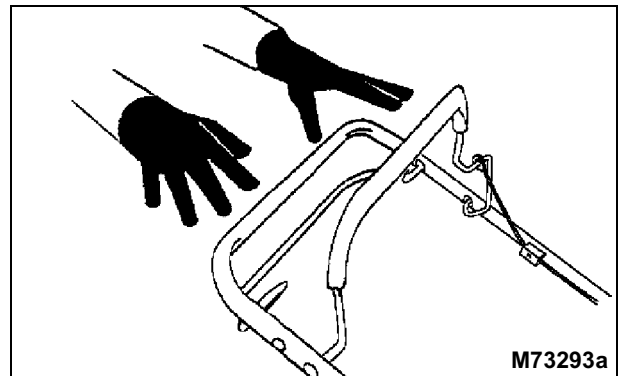

- Mower will stop.
- Blade will stop.
- Engine will stop.

IMPORTANT: Avoid damage! If blade does not stop within 3 seconds after you release blade stop lever, see your John Deere dealer



Suggest:

If the above button click is invalid.

Please download this document

first, and then click the above link

to download the complete manual.

Thank you so much for reading

OPERATING

Using Side Discharge Chute

CAUTION: Avoid injury! DO NOT operate mower unless grass bag assembly, side discharge chute or mulch guard is in place.

1. Release blade control lever to stop engine.



2. Remove mulch guard knob (A).

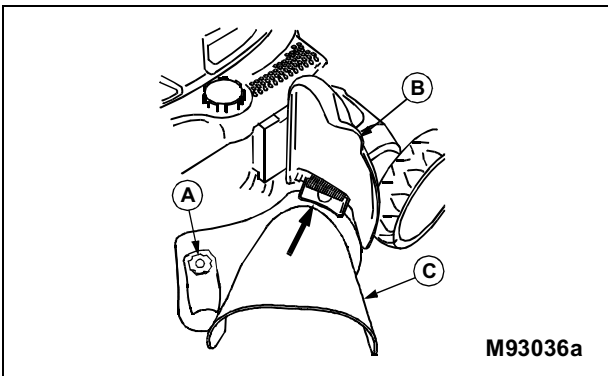

3. Lift and hold spring loaded mulch guard (B) up.
4. Install side discharge chute (C).
 - Slide side discharge chute under mulch guard mounting bracket.
 - Lower mulch guard.
 - Reinstall and tighten knob (A).

Using Grass Bag

CAUTION: Avoid injury! DO NOT operate mower unless mulch guard, side discharge chute or grass bag and bagging chute are in place.

Bagging chute **MUST** be removed and mulch guard secured in place when grass bag is not being used.

NOTE: Bag may wear and deteriorate. Check condition of bag often. Use a John Deere bag or equivalent to comply with safety specifications.

1. Release blade control lever to stop engine.
2. Grasp handle (A) and handle (B) from left side of mower. Lift bag off mower.

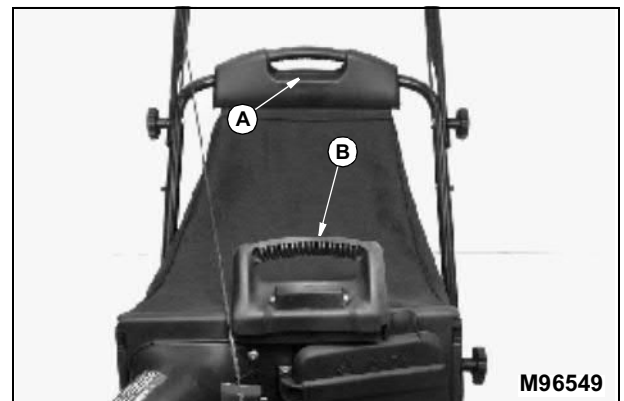

3. Lower front of bag. Raise rear of bag grasping handle (A) and handle (B).



4. Allow doors (C) to swing open. Shake contents of bag to empty out.

Mowing Tips

Before beginning to mow, be sure deck is level and proper cutting height is selected.

<https://www.ebooklibonline.com>

Hello dear friend!

Thank you very much for reading.

Enter the link into your browser.

The full manual is available for immediate download.

<https://www.ebooklibonline.com>