

**John Deere
JD890
Excavator**

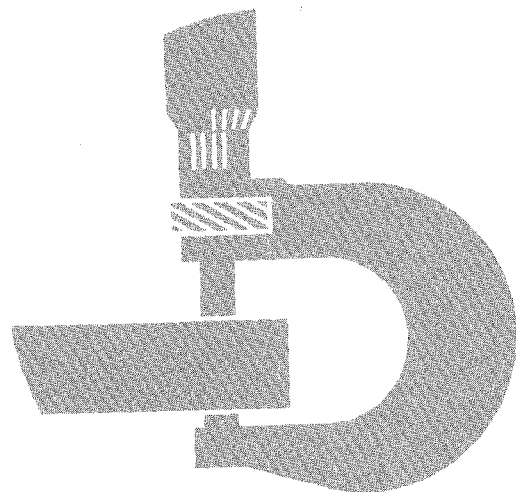

TECHNICAL MANUAL

TM-1163

LITHO IN U.S.A.

SECTION AND GROUP CONTENTS OF THIS MANUAL

SECTION I - GENERAL INFORMATION

- Group I - Contents and Index
- Group II - Introduction and Safety Information
- Group III - General Specifications
- Group IV - Predelivery, Delivery and After-Sales Services
- Group V - Lubrication

SECTION 1 - TRACKS

- Group 0130 - Track Systems
- Group 0199 - Specifications and Special Tools

SECTION 2 - AXLES AND SUSPENSION SYSTEMS

- Group 0250 - Axle Shaft, Bearings, Reduction Gears
- Group 0299 - Specifications and Special Tools

SECTION 4 - ENGINE

- Group 0400 - Engine Removal and Installation
- Group 0401 - Crankshaft and Main Bearings
- Group 0402 - Camshaft and Valve Actuating Means
- Group 0403 - Connecting Rods and Pistons
- Group 0404 - Cylinder Block
- Group 0407 - Oiling System
- Group 0408 - Ventilating System
- Group 0409 - Cylinder Head and Valves
- Group 0410 - Exhaust Manifold
- Group 0413 - Fuel Injection System
- Group 0414 - Intake Manifold
- Group 0416 - Turbocharger
- Group 0417 - Water Pump
- Group 0418 - Thermostats, Housings, and Water Piping
- Group 0419 - Oil Cooler
- Group 0420 - Fuel Filter
- Group 0421 - Fuel Transfer Pump
- Group 0422 - Starting Motor and Fastenings
- Group 0423 - Alternator and Generator Mounting
- Group 0429 - Fan Drive
- Group 0433 - Flywheel, Housing and Fastenings
- Group 0499 - Specifications and Special Tools

SECTION 5 - ENGINE AUXILIARY SYSTEMS

- Group 0505 - Cold Weather Starting Aids
- Group 0510 - Cooling Systems
- Group 0515 - Speed Controls
- Group 0520 - Intake System
- Group 0530 - External Exhaust Systems
- Group 0540 - Mounting Frame
- Group 0560 - External Fuel Supply Systems
- Group 0599 - Specifications and Special Tools

SECTION 13 - MISCELLANEOUS VEHICLE

- Group 1370 - Lubrication Systems

SECTION 16 - ELECTRICAL SYSTEMS

- Group 1671 - Batteries, Support and Cables
- Group 1672 - Alternator, Regulator and Charging System Wiring
- Group 1673 - Lighting System
- Group 1674 - Wiring Harness and Switches
- Group 1675 - System Controls
- Group 1676 - Instruments and Indicators
- Group 1699 - Specifications and Special Tools

SECTION 17 - FRAME, CHASSIS OR SUPPORTING STRUCTURE

- Group 1740 - Frame Installation
- Group 1749 - Chassis Weights

SECTION 18 - OPERATOR'S STATION

- Group 1810 - Operator Enclosure
- Group 1830 - Heating and Air Conditioning
- Group 1899 - Specifications and Special Tools

SECTION AND GROUP CONTENTS OF THIS MANUAL—Continued

SECTION 19 - SHEET METAL AND STYLING

- Group 1910 - Hood or Engine Enclosure
- Group 1913 - Miscellaneous Shields
- Group 1921 - Grille and Grille Housing
- Group 1927 - Fenders

SECTION 20 - SAFETY, CONVENIENCE AND MISCELLANEOUS

- Group 2003 - Fire Extinguisher
- Group 2004 - Horn

SECTION 33 - BACKHOE AND EXCAVATOR

- Group 3301 - Blades, Teeth and Shanks
- Group 3302 - Buckets
- Group 3315 - Controls Linkage
- Group 3340 - Frames
- Group 3360 - Hydraulic System
- Group 3399 - Specifications and Special Tools

SECTION 43 - SWING, ROTATION OR PIVOTING SYSTEM

- Group 4311 - Brakes
- Group 4350 - Mechanical Drive Elements
- Group 4360 - Hydraulic System
- Group 4399 - Specifications and Special Tools

SECTION 90 - SYSTEM TESTING

- Group 9005 - General Information
- Group 9010 - Engine
- Group 9015 - Electrical System
- Group 9020 - Power Train
- Group 9025 - Hydraulic System
- Group 9030 - Miscellaneous Components
- Group 9031 - Heating and Air Conditioning
- Group 9035 - Specifications and Special Tools

<https://www.ebooklibonline.com>

Hello dear friend!

Thank you very much for reading.

Enter the link into your browser.

The full manual is available for immediate download.

<https://www.ebooklibonline.com>

INTRODUCTION

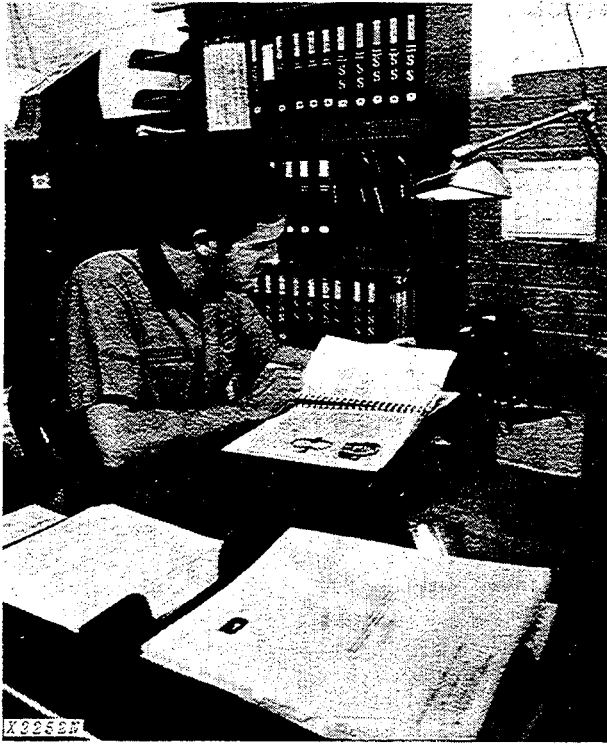

Use FOS Manuals for Reference

This technical manual is part of a twin concept of service:

The two kinds of manuals work as a team to give you both the general background and technical details of shop service.

•FOS Manuals—for reference

Fundamentals of Service (FOS) Manuals cover basic theory of operation, *fundamentals* of trouble shooting, *general* maintenance, and *basic* types of failures and their causes. FOS Manuals are for training new personnel and for reference by experienced technicians.



When a service technician should refer to a FOS Manual for more information, a FOS symbol like the one at the left is used in the Technical Manual.

•Technical Manuals—for actual service

Technical Manuals are concise service guides for specific machines. Technical manuals are on-the-job guides containing only the vital information needed by an experienced service technician.



Use Technical Manuals for Actual Service

This technical manual was written for you—an experienced service technician. Keep it in a permanent binder in the shop where it is handy. Read it when you need to know correct service procedures or specifications.

Some features of this manual:

- Inside front cover - "Table of Contents".
- Section 1 - Contents, safety information, general specifications and general services.
- Sections 1 through 43 - Removal, repair, testing (components removed), installation, and adjustment.
- Section 90 - Detailed explanation of system operation, diagnosis, visual inspection, testing, and adjustments.
- Specifications are listed and illustrated at the end of each section.

MAINTENANCE WITHOUT ACCIDENT WORK SAFELY



T27999N

 This safety alert symbol identifies important safety messages in this manual and on the excavator. When you see this symbol, be alert to the possibility of personal injury and carefully read the message that follows.

EVERY EMPLOYER HAS A SAFETY PROGRAM. KNOW WHAT IT IS!

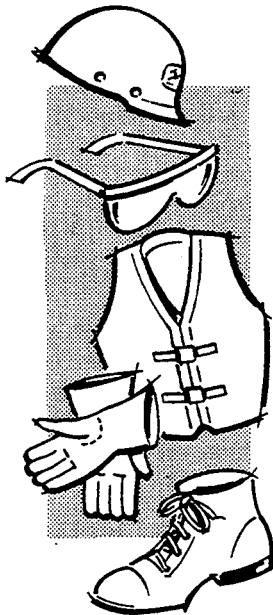

T27501N

See your shop supervisor for specific instructions on a job, and the safety equipment required.

For instance, you may need: Hard hat, safety shoes, safety goggles, heavy gloves, reflector vests, ear protectors, respirator.

Litho in U.S.A.



BE ALERT!

Plan ahead—work safely—know how to use a first-aid kit and a fire extinguisher—and where to get aid.

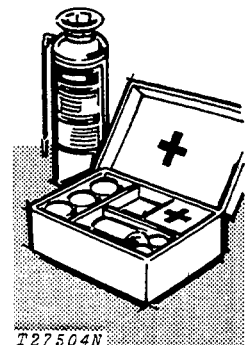

T27504N

Maintenance Area

Make sure the maintenance area has enough ventilation.

Keep the maintenance area CLEAN AND DRY. Oily and wet floors are slippery. Greasy rags are a fire hazard. Wet spots are dangerous when working with electrical equipment.

Keep starting aids in a cool, well-ventilated place, out of reach of unauthorized personnel.

MAINTENANCE WITHOUT ACCIDENT

AVOID FIRE HAZARDS -

Fuel Is Dangerous!

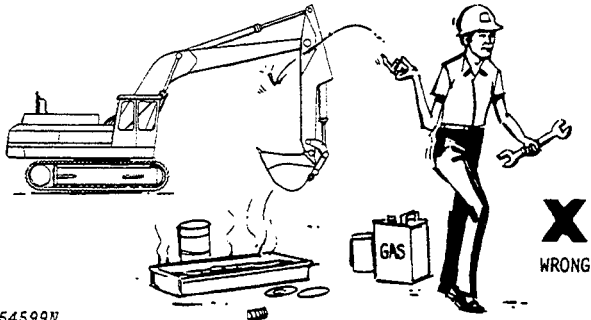

T54599N

Do not smoke while putting fuel in the fuel tank.

Do not smoke while working with material that will start on fire easily.

Stop the engine before filling the fuel tank.

If the engine is hot, use care when putting fuel in the fuel tank.

Do not use gasoline or diesel fuel for cleaning parts. Use solvents that will not start on fire.

Battery Gas Is Highly Flammable!

When charging batteries, be sure there is enough ventilation.

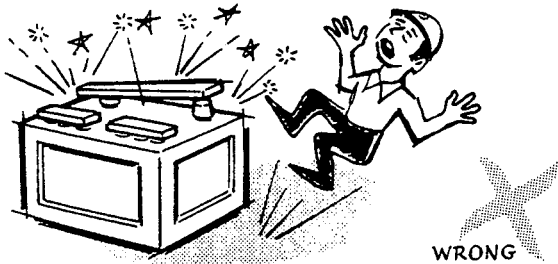

T27506N

Do not check the battery charge by putting metal objects across the posts.

Do not allow sparks or open flame near batteries.

Do not smoke near battery.

Flame Is Not a Flashlight!

NEVER USE OPEN FLAME AROUND THE MACHINE.

KNOW WHERE FIRE EXTINGUISHERS ARE KEPT!

UNDER ALL MAINTENANCE CONDITIONS -

Do not work on the equipment unless you are approved to do so. Then be sure you know the safe and correct procedure.

Never work on equipment while it is being operated.

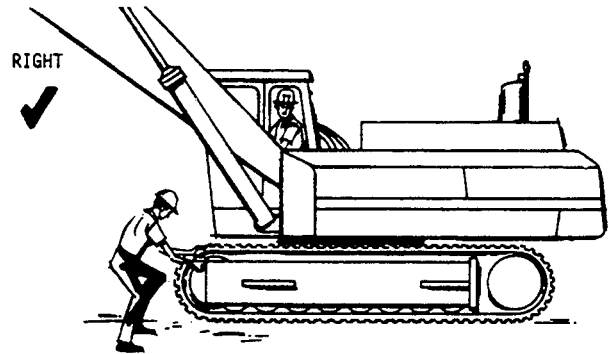

T54600N

When the engine is running, avoid working on equipment.

If you must work on the machine with the engine running, ALWAYS USE TWO service technicians. One must be at the controls. The other must be within sight of the operator.

KEEP HANDS AWAY FROM MOVING PARTS

Put a support under all raised equipment.

Never work under a raised bucket.

Lower the bucket to the ground.

If the machine is on a slope, use blocks to hold it in place.

Do not lift heavy parts by yourself. Use hoisting equipment for this.

TAKE CARE! WATCH OUT FOR OTHER PEOPLE IN THE AREA.

When drilling, grinding, or hammering metal, wear safety glasses.

BE CAREFUL DURING SERVICE AND REPAIR

RIGHT

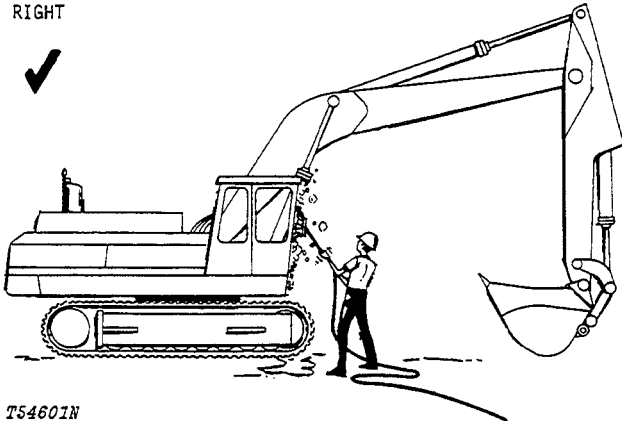

TS4601N

Keep ALL equipment free of dirt and oil.

Clean oil, grease, mud, ice or snow from the operator's station, steps and hand rails.

When getting the engine ready for storage, remember that inhibitor changes easily into gas and is dangerous. After adding the inhibitor, seal and tape openings. When you are not using the inhibitor, keep the can tightly closed.

Do not remove the surge tank cap unless you can hold your hand on the tank. First, loosen the cap slowly to the stop. Then release all pressure in the cooling system before removing the cap.

Check the exhaust system regularly for leaks.

When checking hydraulic pressure, be sure to use the correct test gauge.

Before working on the fuel system, close the fuel shutoff valve.

Before working on the electrical system, or making a major overhaul, disconnect the batteries.

Before working on the hydraulic system:

1. Stop the engine.
2. Lower the bucket to the ground.
3. Move the control levers until the boom and bucket do not move.
4. Remove the hydraulic reservoir filler cap slowly.
5. Open the diffuser vent.
6. Shut off the hydraulic pump valves.

KNOW EQUIPMENT IS READY!

All parts must be in good condition and fastened in place.

RIGHT

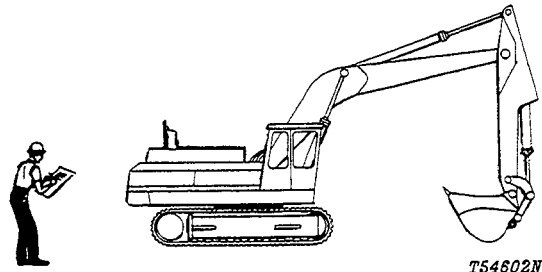

TS4602N

Carefully inspect all system for leaks.

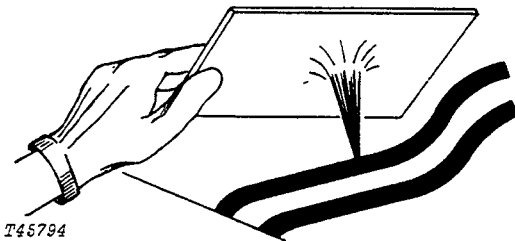

T45794

Use a piece of cardboard or wood, rather than hands, to search for suspected leaks.

Escaping fluid under pressure can penetrate the skin.

If injured by escaping fluid, see a doctor at once.

Group III

GENERAL SPECIFICATIONS

(Specifications and design subject to change without notice. Wherever applicable, specifications are in accordance with PCSA and SAE Standards. Except where otherwise noted, these specifications are based on a unit equipped with 45 in. (1 143 mm) bucket, 30 in. (750 mm) track shoes, and standard equipment.)

Power (at 2100 engine rpm):

	SAE	DIN
Gross	275 hp (205 kW*)	
Net	250 hp (186 kW)	253 PS

Net engine flywheel power is for an engine equipped with fan, air cleaner, water pump, lubricating oil pump, fuel pump, alternator, and muffler. The gross engine power is without fan. Flywheel power ratings are under SAE standard conditions of 500-ft. (150 m) altitude and 85°F (29.5°C) temperature, and DIN 6 270 conditions (non-corrected). No derating is required up to 7,500 ft. (2 286 m) altitude.

*In the International System of Units (SI), power is expressed in kilowatts (kW).

Engine: John Deere turbocharged and intercooled diesel, vertical 6-cylinder, valve-in-head, 4 stroke cycle.

Bore and stroke 5.12 x 5.00 in. (130 x 127 mm)
 Piston displacement 619 cu. in. (10 144 cm³)
 Compression ratio 14.7 to 1
 Maximum torque @
 1400 rpm 810 lb-ft (1 098 Nm) (112 kg-m)
 NACC or AMA (U.S. Tax) horsepower 63
 Lubrication Pressure system w/full-flow filter
 Cooling . Pressurized w/thermostat and fixed bypass
 Fan Suction
 Air cleaner w/restriction indicator Dry
 Electrical system 24 volt w/alternator
 Batteries (2) 12 volt. Reserve capacity; 180 minutes

Hydraulic System:

Three open-center pumps mounted in line are coupled directly to the flywheel. Total flow is 170 gpm (10.72 L/s) at rated engine rpm. System operating pressure is 2800 psi (19 306 kPa) (196.8 kg/cm²) for the propel circuit and 2700 psi (18 616 kPa) (190 kg/cm²) for the digging circuit.

Relief valves:

Boom (2)	3000 psi (20 685 kPa) (210.9 kg/cm ²)
Crowd (2)	3000 psi (20 685 kPa) (210.9 kg/cm ²)
Bucket (2)	3000 psi (20 685 kPa) (210.9 kg/cm ²)

Oil filtration:

Two 10 micron filters in return lines
 Three 25 micron high pressure filters

	Bore	Stroke	Rod Diameter
Cylinders:			
Boom (2)	7.50 in. (190 mm)	62.9 in. (1 597 mm)	3.75 in. (95 mm)
Crowd	7.50 in. (190 mm)	78.2 in. (1 986 mm)	4.50 in. (114 mm)
Bucket	7.50 in. (190 mm)	40.51 in. (1 029 mm)	4.50 in. (114 mm)

All cylinders have phenolic wear rings. Boom, crowd, and bucket cylinders have a built-in hydraulic cushion at each end of the stroke. Full-frontal hydraulic oil cooler is in front of engine coolant radiator.

Operating Information:

Swing speed	5.8 rpm
Digging depth	28 ft. (8.53 m)
Reach at ground level from center of rotation	40 ft. (12.19 m)
Dumping height	21 ft. (6.40 m)
Bucket tangential digging force:	
39, 45, or 51 in. (990, 1 143, or 1 295 mm) bucket	42,500 lb. (190 kN) (19 278 kg) 60 in. (1 524 mm) bucket
33 or 39 in. (838 or 990 mm) heavy-duty bucket	45,000 lb. (202 kN) (20 412 kg) 41,000 lb. (184 kN) (18 598 kg)
45 in. (1 143 mm) heavy-duty bucket	42,500 lb. (190 kN) (19 278 kg)
Gradability	70 percent
Travel (2 speed)	0 to 0.8 mph (1.29 km/h) 0 to 2.1 mph (3.38 km/h)

Buckets: High-strength steel, ribbed and plated bottom section.

Width:	Struck Capacity	Heaped Capacity
39 in. (991 mm)	1-1/4 cu. yd. (0.96 m ³)	1-1/2 cu. yd. (1.15 m ³)
45 in. (1 143 mm) . . .	1-1/2 cu. yd. (1.15 m ³)	1-7/8 cu. yd. (1.43 m ³)
51 in. (1 295 mm) . . .	1-3/4 cu. yd. (1.34 m ³)	2-1/8 cu. yd. (1.62 m ³)
60 in. (1 524 mm) . . .	2-1/8 cu. yd. (1.62 m ³)	3 cu. yd. (2.29 m ³)
33 in. (838 mm) heavy-duty	1-1/4 cu. yd. (0.96 m ³)	1-1/2 cu. yd. (1.15 m ³)
39 in. (991 mm) heavy-duty	1-1/2 cu. yd. (1.15 m ³)	1-7/8 cu. yd. (1.43 m ³)
45 in. (1 143 mm) heavy-duty	1-1/2 cu. yd. (1.15 m ³)	2 cu. yd. (1.53 m ³)

ADCO Buckets: Specially designed for rock, frost, and other tough digging conditions.

Width 26 to 48 in. (660 to 1 219 mm)

Swing Mechanism:

Swing 360-degree, continuous
 Turntable bearing Single row, ball
 Case-hardened ring and pinion gears run in lubricant.

Undercarriage:

Propel motors (one for each track) High-torque
 2-speed hydraulic motors with planetary drives. Wet
 multiple-disk brakes automatically release while propelling, and apply when stationary. Independent drive to each track permits counter-rotation.

Undercarriage, car body, and track frame Each track frame is a formed, reinforced U-channel. Track frames are joined by reinforced boxed car body with swing bearing mount.

Track Rollers and Idlers:

9 rollers and 1 idler per track. All rollers and idlers have metal-faced seals. Track recoil system is actuated by a heavy-duty nitrogen cylinder. Through-hardened steel slides support and guide upper track.

Track Chain Sealed track chain

Track Shoes:	Ground Contact	Ground Pressure
Width	Shoes	Pressure
30 in. (750 mm)	Triple semi-grousers	9723 sq. in. (62 731 cm ²) 9.18 psi (63.3 kPa) (0.65 kg/cm ²)
36 in. (900 mm)	Triple semi-grousers (optional)	11,668 sq. in. (75 278 cm ²) 7.85 psi (54.1 kPa) (0.55 kg/cm ²)
Track adjustment		Hydraulic

Cab:

Steel, with urethane sound-proofing on ceiling and sidewalls, and cushioned neoprene floor mat. Safety glass on all sides. Lexan window in roof. Front and rear windows open. Front window is removable.

Seat:

Fully adjustable, foam rubber cushioned seat.

Controls:

Two-lever for boom, crowd, bucket, and swing. Right and left pedals control forward and rearward movement of right and left tracks respectively.

Boom and Dipperstick:

Tapered box construction with heat-treated steel bushings. Machined and bored after welding for accurate alignment. All pivot points are sealed to allow extended lubrication intervals.

Servicing and Vandal Protection:

Swingaway service doors expose built-in platforms for easy access to engine and hydraulic systems. Cab and access covers to fuel tank, surge tank, cables, and hydraulic reservoir all lock with key.

Capacities:	U.S.	Imp.	Liters
Fuel tank	128 gal.	106.7 gal.	484.5
Cooling system	19 gal.	15.8 gal.	72
Engine lubrication	32 qt.	26.7 qt.	30.3
Engine lubrication, including filter	34 qt.	28.3 qt.	32.2
Hydraulic system	220 gal.	183.3 gal.	832.8
Planetary propel drive (each)	21 qt.	17.5 qt.	20.0
Swing drive (each)	8 qt.	6.7 qt.	7.5

Additional Standard Equipment:

- Electric hour meter
- Alternator charge indicator light
- Hydraulic oil filter pressure warning light
- Stop engine indicator light
- Engine coolant temperature gauge
- Fuel gauge
- Hydraulic oil temperature gauge
- Engine oil pressure gauge
- Key switch
- Horn
- Deluxe seat

Positive-position hand throttle

15,000 lb. (6 804 kg) counterweight with removal system

Track guides

Vandal protection

Cab with heater

Floor mat

Cold weather starting aid

Engine coolant conditioner-filter

Operating Weight:

	lb.	kg
Excavator less bucket:		
30 in. (750 mm) track shoes	86,630	39 295
36 in. (900 mm) track shoes	88,930	40 339

Bucket Shipping Weight:

	lb.	kg
39 in. (991 mm)	2550	1 158
45 in. (1 143 mm)	2670	1 212
51 in. (1 295 mm)	2820	1 230
60 in. (1 524 mm)	2900	1 315
33 in. (838 mm) heavy-duty	3060	1 389
39 in. (991 mm) heavy-duty	3550	1 612
45 in. (1 143 mm) heavy-duty	3635	1 650

Special Equipment:

- 36 in. (900 mm) triple semigrouser shoes
- Bucket side cutter
- Fire extinguisher
- Engine water heater
- Window protection group
- Air conditioner
- 310 minute reserve battery
- ADCO buckets (26 in. [660 mm] to 48 in. [1 219 mm] widths)

JD890 DIMENSIONS

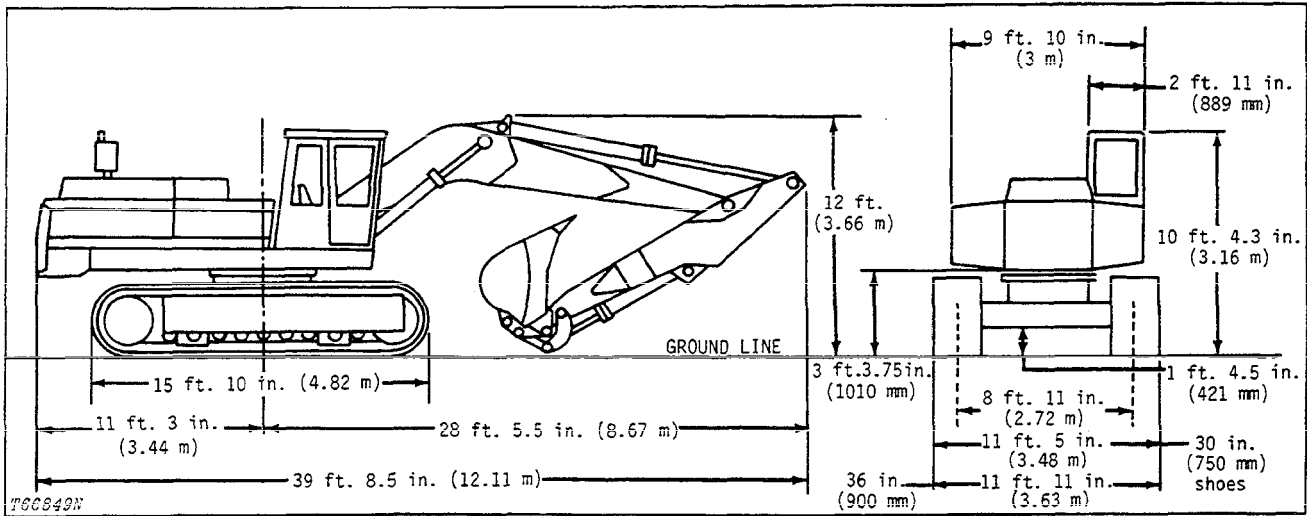

Digging Depth and Lifting Height: 40 ft. (12.19 m)

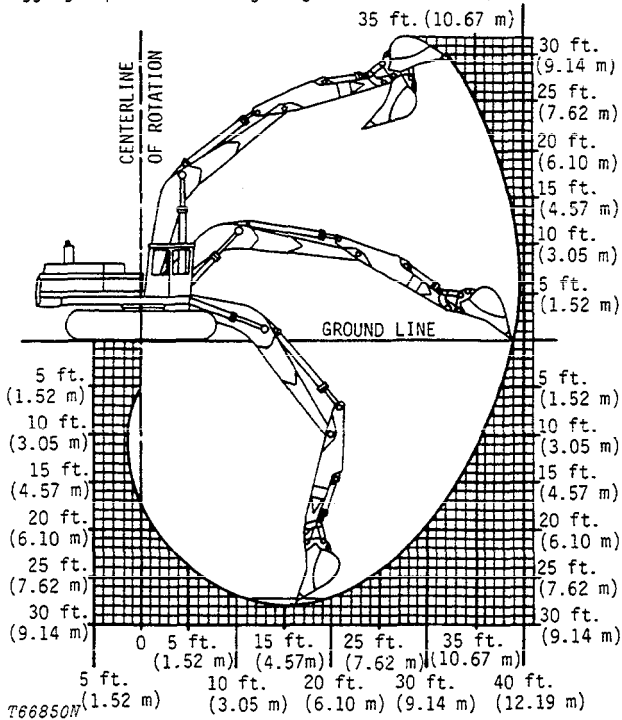

2. Batteries

Check the electrolyte level of the batteries. If distilled water is not available, use clean soft water. Do not use hard water. Remove dirt from the top of the batteries with a damp cloth. Put petroleum jelly on terminals.

IMPORTANT: Never add water to the batteries in freezing weather unless the engine will be run 2 or 3 hours.

Check battery connections.

Punch date code on batteries.

Batteries checked Yes No

3. Fuel Supply Pump Sediment Bowl

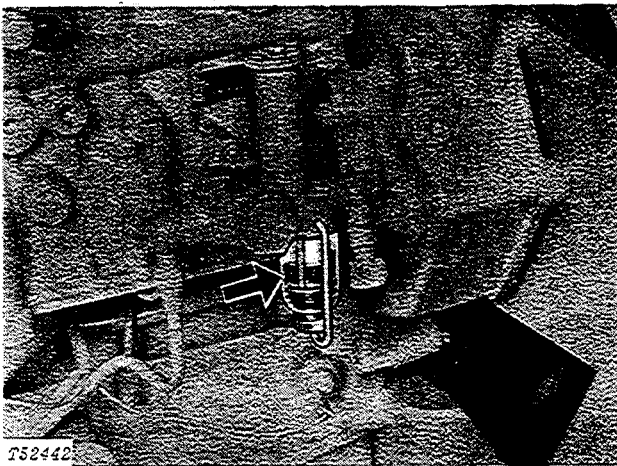

Fig. 2-Fuel Supply Pump Sediment Bowl

Release the clamp from the sediment bowl of the fuel supply pump.

Remove the sediment bowl.

Remove the filter screen from inside the bowl. Clean it with diesel fuel.

Clean the sediment bowl. Install the screen.

Install the sediment bowl.

Drain the fuel filters. See item 4.

Remove air from the fuel system (see page I-IV-21).

Sediment bowl cleaned Yes No

4. Fuel Filters

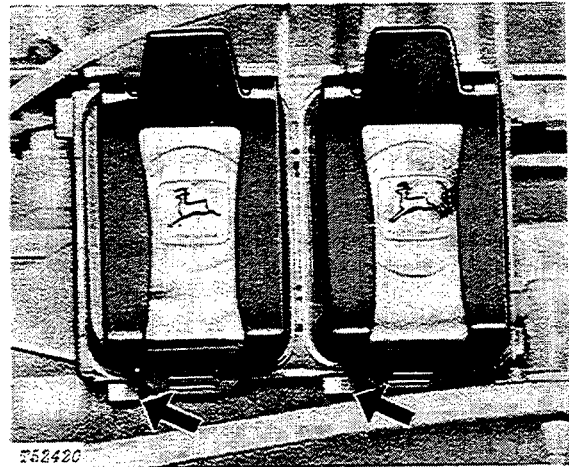

Fig. 3-Fuel Filter Drain Screws

Check fuel filters for sediment. Drain the sediment, if necessary.

Loosen the drain screws. Let all water and sediment drain. Tighten the drain screws.

Remove air from the fuel system after draining sediment. See page I-IV-21.

Fuel filters drained Yes No

5. Cold Weather Starting Aid

To check the cold weather starting aid, remove the starting fluid can from the engine. Push the starting aid button (on the switch panel). Listen for the solenoid "click". A "click" shows that the starting aid system is working correctly.

Cold weather starting aid checked Yes No

6. Belt Tension

Check the tension on the alternator belt, front fan belt, and compressor belt. Change the tension, if necessary.

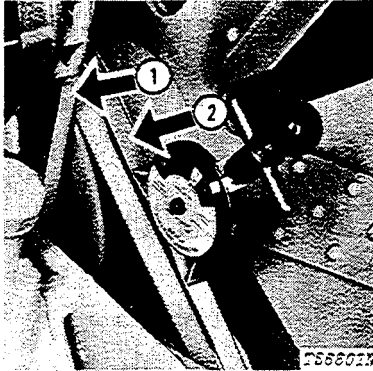

1—Alternator Belt 2—Front Fan Belt

Fig. 4-Strand Tension Gauge

Immediately after the engine stops (run the engine at least 5 minutes), check the belt tension on all belts. If tension is less than 50 lb. (223 N) (23 kg), let the engine cool 10 to 15 minutes. Then make tension 90 lb. (400 N) (41 kg).

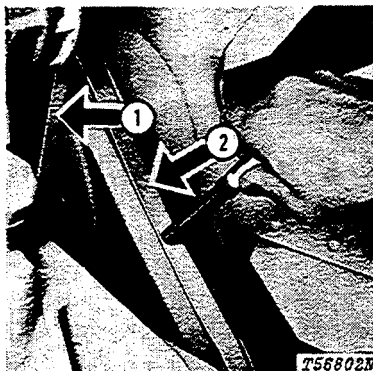

1—Alternator Belt 2—Front Fan Belt

Fig. 5-Tension Tester

A force of 20 lb. (89 N) (9 kg) halfway between the pulleys must move the belt 3/4 in. (19 mm).

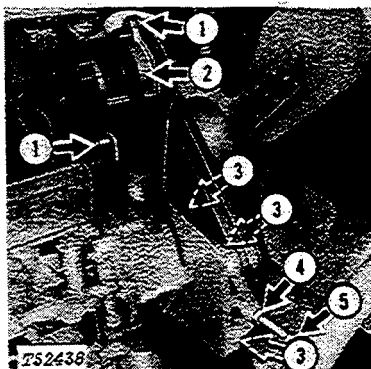

Fig. 6-Adjusting Tension

Litho in U.S.A.

Alternator belt: Loosen the cap screws (1).

IMPORTANT: Apply outward force to the FRONT alternator frame only.

Tighten the cap screws (1). Fan belts: Loosen cap screws (3) and lock nut (4). Turn the jack screw (5). Tighten the cap screws (3) and lock nut (4).

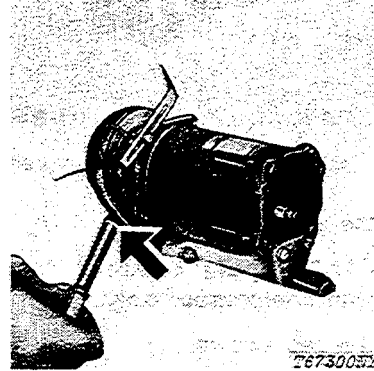

Fig. 7-Tension Tester on Compressor

A force of 15 lb. (67 N) (7 kg) halfway between pulleys must move the belt 1/4 inch (6 mm).

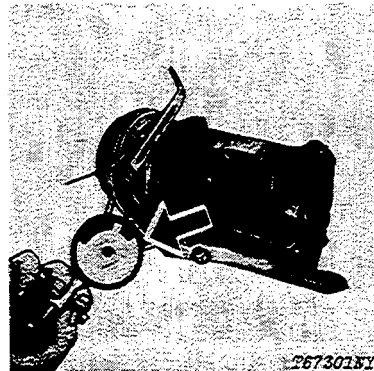

Fig. 8-Strand Tension Gauge on Compressor

Tension must be 90 lb. (400 N) (41 kg).

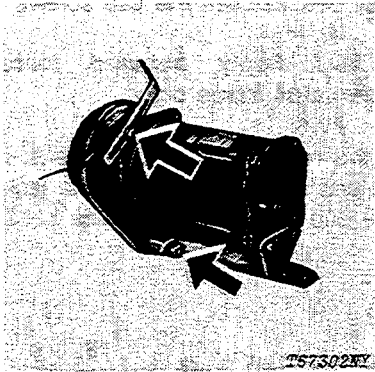

Fig. 9-Adjustment of Compressor Belt

Loosen the cap screws (Fig. 9).

IMPORTANT: Apply outward force to the FRONT of the compressor only.

Tighten the cap screws.

Belt tension checked Yes No

7. Crankcase Oil Level

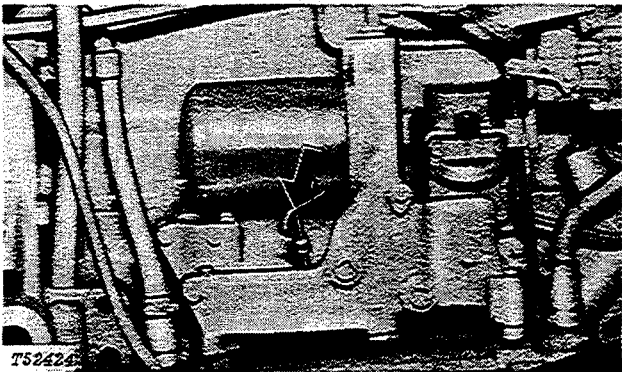

Fig. 10-Crankcase Dipstick

Check the oil level when the excavator is on a level surface.

Wait 10 minutes after stopping the engine for oil to drain down.

If oil is not between the marks on the dipstick, add oil specified on page I-V-2.

NOTE: There is two quarts (1.89 L) difference between the bottom mark and the top mark on the dipstick.

Crankcase oil level checked Yes No
Oil added _____qts. (L)

8. Swing Gearbox Oil Level

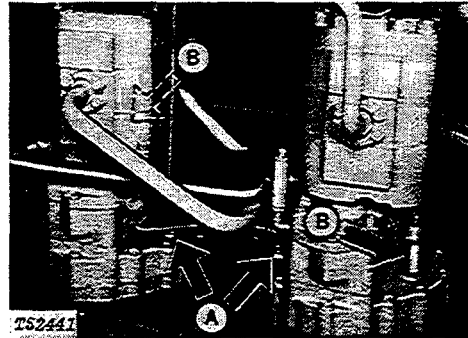

A—Check Plug

B—Vent Tube

Fig. 11-Swing Gearbox

Check the oil level of the swing gearbox.

Oil must be to the bottom of the check plug hole. If not, remove the vent tube. Add oil specified on page I-V-2.

Install the check plug and the vent tube.

Swing gearbox oil level checked Yes No
Oil added _____qts. (L)

9. House Lock Oil Level

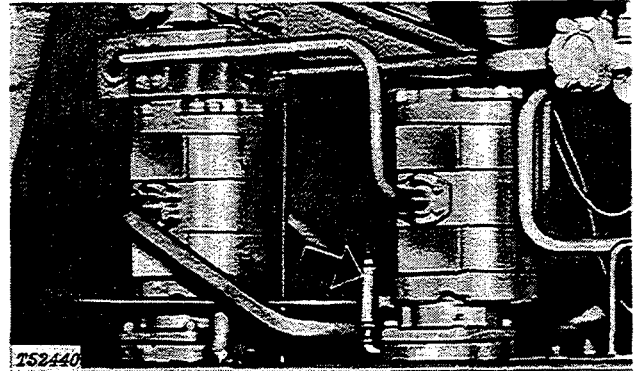

Fig. 12-House Lock Vent Tube

Stop the engine. Remove the vent tube of the house lock. Oil must be to the bottom of the vent tube hole. If not, add oil specified on page I-V-2.

Install the vent tube.

House lock oil level checked Yes No
Oil added _____qts. (L)

10. Swinging Gear

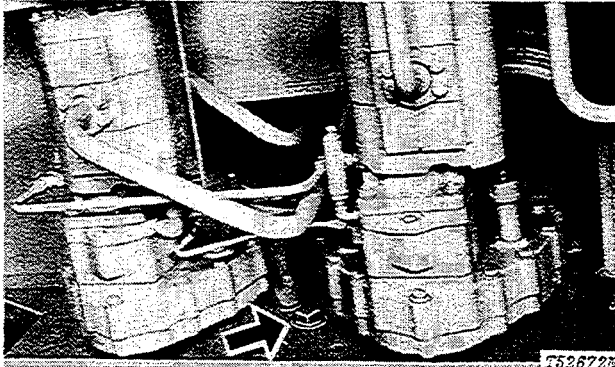
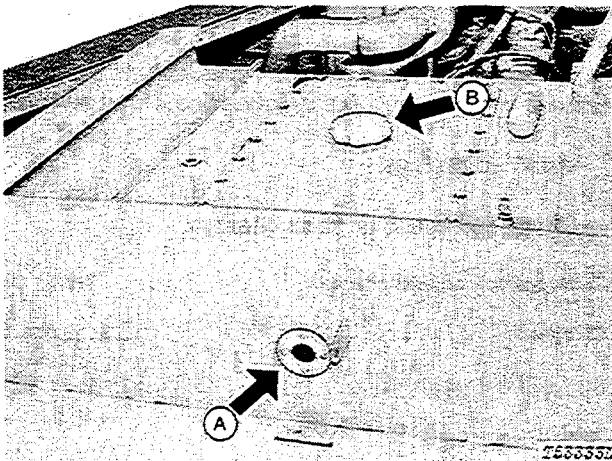

Fig. 13-Swinging Gear Filler Plug

Remove the filler plug. Check for sufficient grease. Add grease specified on page I-V-2 if needed.

Swinging gear checked. Yes No
 Grease added _____lb. (kg)

11. Hydraulic System Oil Level



A—Oil Level Window B—Filler Cap

Fig. 14-Hydraulic Reservoir

Check the oil level of the hydraulic reservoir.

The excavator must be on level ground. Extend all cylinders halfway.

Oil level must be to middle of the oil level window.

NOTE: Add 3-1/2 gallons (13 L) of oil to raise the oil level in the reservoir 1 in. (25.4 mm).

If oil is needed, add oil specified on page I-V-2.

IMPORTANT: If oil in the lower part of the sight glass cannot move, it does not necessarily show the oil level of the reservoir.

Oil level checked Yes No
 Oil added _____qts. (L)

12. Propel Brake Oil Level

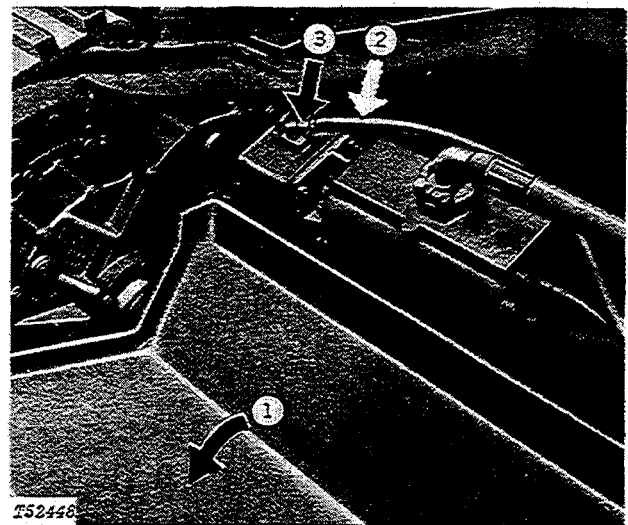
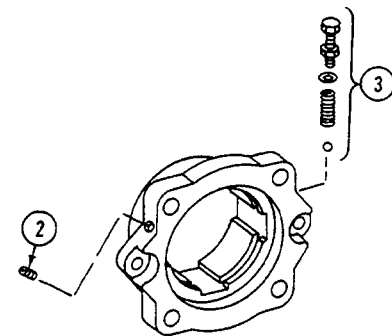

Fig. 15-Propel Brake



T63778N

Fig. 16-Propel Brake Oil Level

Check the oil level as follows:

1. Remove the cap screw from the propel motor cover. Pull the cover down.

2. Remove the pipe plug. Oil must come out of the pipe plug hole.
3. If not, remove the breather vent, washer, spring, and steel ball. Put these parts in a safe place. Add oil specified on page I-V-2.
4. Install all parts.

IMPORTANT: If the breather vent is dirty, flush it with fuel oil or solvent. Use compressed air to clean the breather vent.

Propel brake oil level checked Yes No
 Oil added _____ qts. (L)

13. Fuel Tank Level and Sump

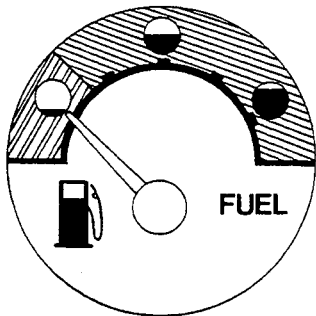

T40227N

Fig. 17-Fuel Level Gauge

Open the fuel tank drain cock. Drain liquid for several seconds. Close the drain cock.

Fill the fuel tank with correct fuel.

Check the operation of the fuel gauge.

The fuel gauge shows the amount of fuel in the fuel tank.

Fuel tank sump drained Yes No
 Fuel tank filled Yes No

14. Track

Track Gearbox Oil Level

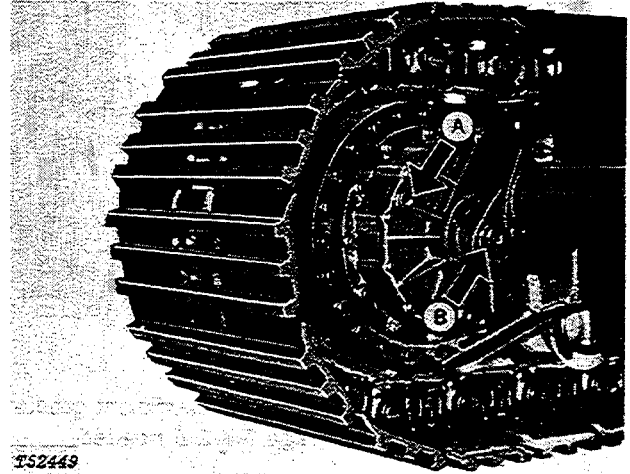

T52449

A—Fill Plug B—Check Plug

Fig. 18-Track Gearbox

Remove the check plug of the track gearbox.

Oil must be to the level of the check plug hole. If not, remove the fill plug. Add oil specified on page I-V-2.

Install both plugs.

Check the opposite track gearbox.

Track gearbox oil level checked Yes No
 Oil added _____ qts. (L)

Track Shoe Hardware

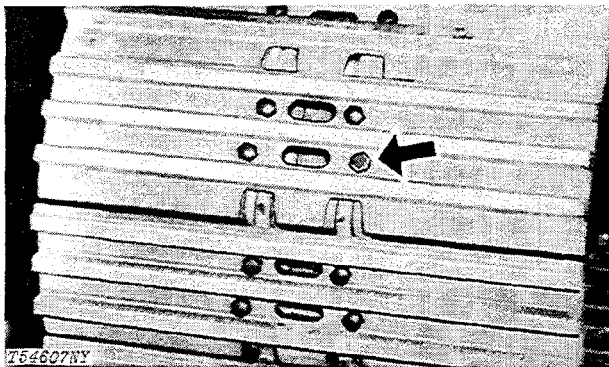
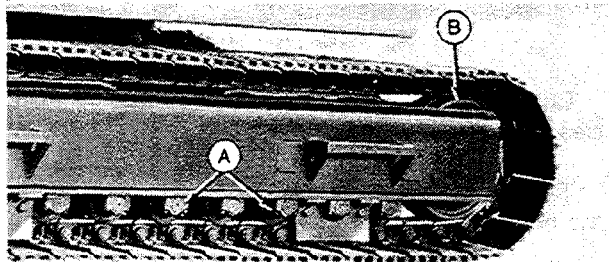

Fig. 19-Track Shoe Bolts

Tighten track shoe bolts to 420 lb-ft (570 Nm) (58 kg-m).

Bolts tightened Yes No

Track Rollers and Idlers



T54608NY

A—Track Rollers B—Front Idler

Fig. 20-Track Rollers and Idler

To check the oil level, turn the roller or idler so the pipe plug is at a 45° angle from the top. Remove the pipe plug. Oil must be to the bottom of the plug hole. If not, fasten a plastic tube to an oil can. Add oil through the plug hole. Use oil specified on page I-V-2.

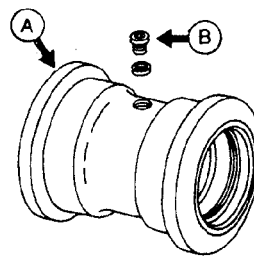

T54609N

A—Roller
 B—Pipe Plug

Fig. 21-Track Roller

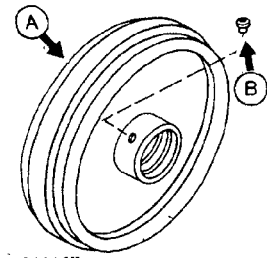

T54610N

A—Idler
 B—Pipe Plug

Fig. 22-Idler

Apply Loctite sealant to pipe plug and install the plug flush with the surface.

Rollers and idlers oil level checked Yes No

Oil added _____qts. (L)

Track Sag

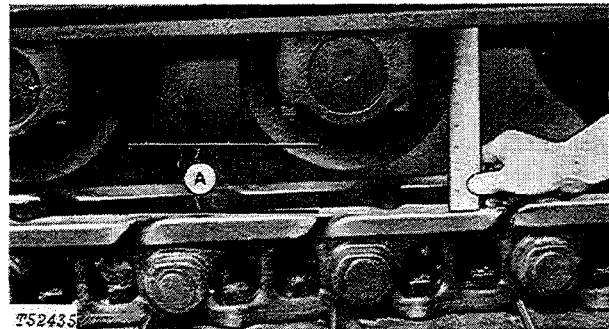

T5243S

A—3 to 5 inches (76-127 mm)

Fig. 23-Measuring Track Sag

NOTE: When changing from one ground condition to a different ground condition, check the track sag after a short time of operation.

1. Swing the house to the left (L.H.) until the house is at a 90° angle to the undercarriage.
2. Lower the bucket to the ground. Push on the ground with the bucket until the left (L.H.) track is several inches above the ground.

CAUTION: Never work under the excavator while it is raised by the boom.



Suggest:

If the above button click is invalid.

Please download this document

first, and then click the above link

to download the complete manual.

Thank you so much for reading

3. Push down the rear of the left (L.H.) propel pedal. Turn the left (L.H.) track backwards until all sag is removed from the upper part of the track.
4. Measure the track sag. Sag must be between 3 to 5 inches (76 to 127 mm) from the running surface of the center track roller to the top of the chain.

See page I-IV-29 for track sag adjustment.

Track sag measured _____ in. (mm)

15. Surge Tank

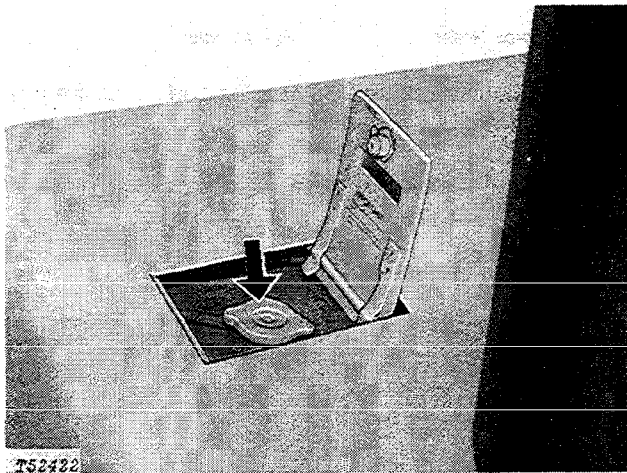

Fig. 24 - Surge Tank Filler Cap

Check the engine coolant level in the sight glass. The engine must be stopped. The machine must be on a level surface.

Open the left (L.H.) fender. Coolant must be in the sight glass.

If coolant is needed, remove the filler cap from the surge tank.

CAUTION: Do not remove the surge tank filler cap unless you can hold your hand on the surge tank. First, loosen the cap slowly to the stop. Then release all pressure in the cooling system before removing the cap.

Keep coolant at the bottom of the surge tank filler neck when the engine is cold. Do not overfill. Use clean water for warm weather. Use a solution of 50% clean water and 50% permanent antifreeze (ethylene glycol with approved rust inhibitor) for cold weather.

Tighten the filler cap. Check for leaks and loose connections.

Clean the hydraulic oil cooler fins, if necessary.

Coolant level checked Yes No

Coolant or antifreeze added Yes No

16. Air Intake Hoses

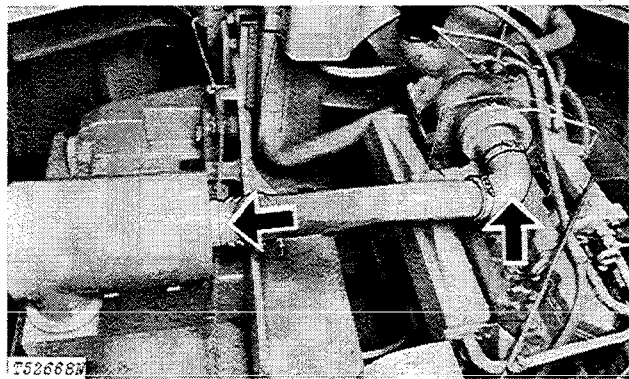

Fig. 25 - Air Intake Hoses

Check the clamps on the hoses that connect the air cleaner and the engine.

Tighten the four hose clamps, if necessary. Inspect the hoses for cracks.

Air intake hoses checked Yes No

<https://www.ebooklibonline.com>

Hello dear friend!

Thank you very much for reading.

Enter the link into your browser.

The full manual is available for immediate download.

<https://www.ebooklibonline.com>