

**John Deere
JD855
Crawler Loader**

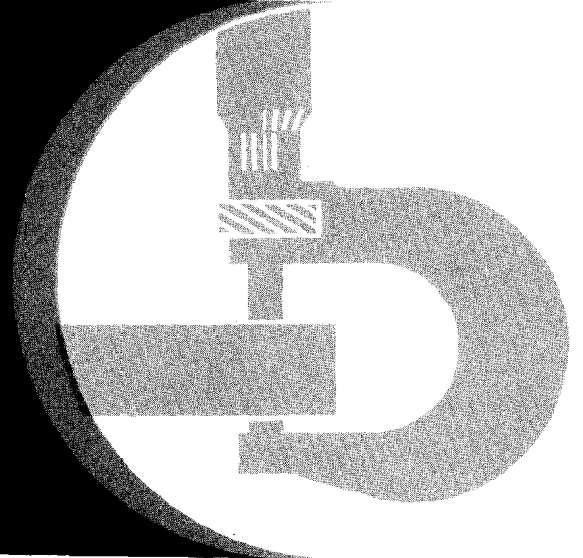

TECHNICAL MANUAL

TM-1165

Litho in U.S.A. (T) New

SECTION AND GROUP CONTENTS OF THIS MANUAL

SECTION I - GENERAL INFORMATION

- Group I - Contents and Index
- Group II - Introduction and Safety Information
- Group III - General Specifications
- Group IV - Predelivery, Delivery and After-Sale Services
- Group V - Fuels and Lubricants

SECTION 1 - TRACKS

- Group 0130 - Track Systems
- Group 0199 - Specifications and Special Tools

SECTION 2 - AXLES AND SUSPENSION SYSTEMS

- Group 0201 - Drive Axle Housing and Support
- Group 0250 - Axle Shaft, Bearings and Reduction Gears
- Group 0299 - Specifications and Special Tools

SECTION 3 - TRANSMISSION

- Group 0315 - Controls
- Group 0325 - Input Drive Shafts and U-Joints
- Group 0360 - Hydraulic System
- Group 0370 - Clutch Disconnect and Controls
- Group 0399 - Specifications and Special Tools

SECTION 4 - ENGINE

- Group 0400 - Engine Removal and Installation
- Group 0401 - Crankshaft and Main Bearings
- Group 0402 - Camshaft and Valve Actuating Means
- Group 0403 - Connecting Rods and Pistons
- Group 0404 - Cylinder Block
- Group 0407 - Oiling System
- Group 0408 - Ventilating System
- Group 0409 - Cylinder Head and Valves
- Group 0410 - Exhaust Manifold
- Group 0413 - Fuel Injection System
- Group 0414 - Intake Manifold
- Group 0416 - Turbocharger
- Group 0417 - Water Pump
- Group 0418 - Thermostats, Housings and Piping
- Group 0419 - Oil Cooler
- Group 0420 - Fuel Filter
- Group 0421 - Fuel Transfer Pump
- Group 0422 - Starting Motor
- Group 0423 - Alternator and Generator Mounting
- Group 0429 - Fan Drive
- Group 0433 - Flywheel, Housing and Fasteners
- Group 0499 - Specifications and Special Tools

SECTION 5 - ENGINE AUXILIARY SYSTEMS

- Group 0505 - Cold Weather Starting Aids
- Group 0510 - Cooling System
- Group 0515 - Speed Controls
- Group 0520 - Intake System
- Group 0530 - External Exhaust System
- Group 0540 - Mounting Frame
- Group 0560 - External Fuel Supply System
- Group 0599 - Specifications and Special Tools

SECTION 8 - TRANSFER DRIVE

- Group 0841 - Housing and Covers
- Group 0851 - Gears, Shafts, Bearings
- Group 0899 - Specifications and Special Tools

SECTION 11 - PARKING-EMERGENCY BRAKE

- Group 1111 - Active Elements
- Group 1115 - Controls Linkage
- Group 1160 - Parking Brake Hydraulic
- Group 1199 - Specifications and Special Tools

SECTION 15 - EQUIPMENT ATTACHING

- Group 1511 - Drawbar
- Group 1512 - Towbar

SECTION 16 - ELECTRICAL SYSTEM

- Group 1671 - Batteries, Supports and Cables
- Group 1672 - Alternator, Regulator and Charging System Wiring
- Group 1673 - Lighting System
- Group 1674 - Wiring Harness and Switches
- Group 1675 - System Controls
- Group 1676 - Instruments and Indicators
- Group 1699 - Specifications and Special Tools

SECTION 17 - FRAME, CHASSIS OR SUPPORTING STRUCTURE

- Group 1740 - Frame Installation
- Group 1746 - Frame Bottom Guards
- Group 1749 - Chassis Weights

SECTION 18 - OPERATOR'S STATION

- Group 1810 - Operator Enclosure
- Group 1821 - Seat
- Group 1830 - Heating and Air Conditioning
- Group 1899 - Specifications and Special Tools

SECTION AND GROUP CONTENTS OF THIS MANUAL—Continued

SECTION 19 - SHEET METAL AND STYLING

- Group 1910 - Hood or Engine Enclosures
- Group 1913 - Miscellaneous Shields
- Group 1921 - Grille and Grille Housing
- Group 1927 - Fenders

**SECTION 20 - SAFETY, CONVENIENCE
AND MISCELLANEOUS**

- Group 2003 - Fire Extinguisher
- Group 2004 - Horn and Warning Devices
- Group 2006 - Cigar Lighter

SECTION 31 - LOADER

- Group 3102 - Buckets
- Group 3115 - Controls Linkage
- Group 3140 - Loader Frames
- Group 3160 - Hydraulic System
- Group 3199 - Specifications and Special Tools

SECTION 40 - PTO OR WINCH DRIVE

- Group 4041 - Housing and Covers

SECTION 42 - GROUND CONDITIONING TOOL

- Group 4215 - Controls Linkage
- Group 4260 - Hydraulic System

SECTION 90 - SYSTEM TESTING

- Group 9005 - General Information - Seven Basic Steps of Testing and Diagnosis
- Group 9010 - Engine
- Group 9015 - Electrical System
- Group 9020 - Power Train
- Group 9025 - Hydraulic System (Flow Meter)
- Group 9025A - Hydraulic System (Analyzer)
- Group 9026 - Hydrostatic System
- Group 9030 - Miscellaneous Components
- Group 9031 - Heating and Air Conditioning
- Group 9035 - Specifications and Special Tools

<https://www.ebooklibonline.com>

Hello dear friend!

Thank you very much for reading.

Enter the link into your browser.

The full manual is available for immediate download.

<https://www.ebooklibonline.com>

ALPHABETICAL INDEX

A

After-sale inspection I-IV-16 - I-IV-28
 Air cleaner I-IV-20
 Air intake hose I-IV-20
 Alternator-fan compressor
 belt tension I-IV-20 - I-IV-22
 Batteries I-IV-26
 Cab air filter I-IV-25
 Charging system I-IV-27
 Engine coolant conditioner
 filter I-IV-22
 Engine crankcase oil and
 filter element I-IV-17
 Final drive housing oil level I-IV-19
 Fluid leakage I-IV-28
 Fuel tank sump I-IV-23
 Hydraulic brake (park brake) I-IV-28
 Hydraulic oil level I-IV-18
 Hydrostatic transmission
 oil level I-IV-18
 Indicator lights and gauges I-IV-26 - I-IV-27
 Lubrication I-IV-25
 Radiator coolant level I-IV-22
 Splitter gearbox oil level I-IV-19
 Track shoe cap screws I-IV-25
 Track tension adjustment I-IV-23 - I-IV-24
 Air conditioning relay 1674-4
 Air conditioning system 1830-5 - 1830-30
 Blower motor 1830-29
 Components 1830-30
 Compressor 1830-5 - 1830-20
 Compressor relief valve 1830-26
 Condenser 1830-21 - 1830-22
 Evaporator 1830-24
 Expansion valve 1830-25
 High temperature switch 1830-28
 Receiver - dryer 1830-23
 Superheat shut-off switch 1830-27
 Thermal fuse 1830-27
 Thermostatic temperature control
 switch 1830-25 - 1830-26
 Air conditioning system testing 9031-2 - 9031-19
 Component location 9031-2 - 9031-3
 Diagnosing malfunctions 9031-8
 Diagnosis flow chart 9031-10
 Operational diagnostic chart 9031-9
 Safety precautions 9031-11
 Schematic 9031-11

Air conditioning system testing—Continued

System service 9031-12 - 9031-19
 Adding refrigerant - 12 to
 system 9031-18
 Charging system 9031-16 - 9031-17
 Discharging system 9031-14
 Electrical testing 9031-14
 Evacuating system 9031-15
 Flushing system components 9031-19
 Inspecting refrigerant
 hoses and tubing 9031-20
 Leak testing 9031-19
 Operational test 9031-14
 Purging the system 9031-20
 Pressure gauges 9031-12 - 9031-13
 Visual operating checks 9031-7
 Visual preliminary checks 9031-7
 Air intake system, engine 0520-1 - 0520-2
 Air restriction indicator 1676-2
 Alarm, reverse warning 2004-2
 Alternator, 16 amp 1672-2 - 1672-13
 Components 1672-4
 Test after assembly 1672-13
 Alternator, 50 amp 1672-14 - 1672-26
 Components 1672-16
 Automatic control valve shut-
 off valve control 0315-13 - 0315-14
 Automatic control valve variable
 orifice linkage 0315-10 - 0315-11
 Axle shaft, bearings, and
 reduction gears 0250-1 - 0250-18
 Components 0250-1
 Final drive housing cover with
 gears and shafts 0250-12 - 0250-18
 Planet housing with pinions and
 shafts 0250-2 - 0250-11
 Axles and suspension systems:
 Axle shaft, bearings and reduc-
 tion gears 0250-1 - 0250-18
 Drive axle housing and support 0201-3 - 0201-6

B

Batteries, support and cables 1671-3 - 1671-7
 Charging battery 1671-7
 Inspection 1671-4 - 1671-5
 Testing 1671-5 - 1671-6
 Battery disconnect switch 1674-2
 Block, cylinder 0404-1 - 0404-6
 Blower motor 1830-29

Brake valve 1160-1 - 1160-4
Brakes, parking-emergency
 Active elements 1111-3 - 1111-5
 Controls linkage 1115-1 - 1115-2
 Hydraulic system 1160-1 - 1160-4
Brush shields 1910-6
Buckets 3102-3 - 3102-4
Bypass valve, transmission 0360-38 - 0360-39

C

Cab 1810-3 - 1810-5
Cab relay 1674-4
Camshaft and valve actuating
 means 0402-1 - 0402-4
Carrier rollers 0130-4 - 0130-7
Chain, track 0130-13 - 0130-22
Charge pump 0360-31 - 0360-32
Chassis weights 1749-1
Cigar, lighter 2006-1
Circuit breakers 1674-5
Clutch disconnect and controls 0370-1 - 0370-6
 Clutch elements 0370-3 - 0370-6
 Controls 0370-1 - 0370-2
Cold weather starting aids 0505-3 - 0505-5
 Engine coolant heater 0505-5
 Starting aid adapter, line
 and nozzle 0505-4
 Starting aid solenoid 0505-3 - 0505-4
 Starting aid switch 0505-4
Component location:
 Air conditioning system 9031-2 - 9031-3
 Electrical system 9015-2 - 9015-5
 Engine system 9010-2 - 9010-4
 Heating system 9031-2 - 9031-3
 Hydraulic system (flow meter) 9025-3
 Power train system 9020-2 - 9020-3
Compressor 1830-5 - 1830-20
Compressor relief valve 1830-26
Condenser 1830-21 - 1830-22
Connecting rods and pistons 0403-1 - 0403-6
Control valve, loader 3160-13 - 3160-21
Controls linkage, double selector
 valve 4215-3
Coolant filter/conditioner 0510-1 - 0510-3
Cooling systems, engine 0510-1 - 0510-4
Cover, PTO 4041-3
Cowl 1910-4
Crankshaft and main bearings 0401-1 - 0401-7
 Installation 0401-4 - 0401-7
Cylinder block 0404-1 - 0404-6

Cylinder, loader 3160-22 - 3160-32
Cylinder head and valves 0409-1 - 0409-6
Cylinder, track adjuster 0130-29 - 0130-31

D

Delco-Remy starting motor 0422-1 - 0422-10
Delivery service I-IV-16
Diagnosing malfunctions:
 Air conditioning system 9031-8
 Electrical system 9015-8 - 9015-10
 Engine system 9010-5 - 9010-7
 Heating system 9031-1
 Hydraulic system (flow meter) 9025-21 - 9025-23
 Power train system 9020-10 - 9020-11
 Track 9030-1
Double selector valve 4260-1
Double selector valve control linkage 4215-3
Drawbar 1511-3
 Components 1511-3
Drive axle housing and support 0201-3 - 0201-6

E

Electrical sensing gauges and
 indicators 1676-4 - 1676-6
Electrical system testing 9015-1 - 9015-32
 Block diagram 9015-6
 Component location 9015-2 - 9015-5
 Diagnosing malfunctions 9015-8 - 9015-10
 Precautions 9015-11 - 9015-12
 Schematic 9015-7, 9015-31
 Testing and adjustments 9015-13 - 9015-30
 Visual inspection 9015-12
 Wiring diagram 9015-7, 9015-32
Electrical systems:
 Alternator, regulator and
 charging system wiring 1672-1 - 1672-26
 Batteries, support and cables 1671-3 - 1671-7
 Instruments and indicators 1676-1 - 1676-6
 Lighting system 1673-1 - 1673-2
 System controls 1675-1 - 1675-2
 Wiring harness and switches 1674-1 - 1674-6
Engine:
 Camshaft and valve actuating
 means 0402-1 - 0402-4
 Connecting rods and pistons 0403-1 - 0403-6
 Crankshaft and main bearings 0401-1 - 0401-7
 Cylinder block 0404-1 - 0404-6
 Cylinder head and valves 0409-1 - 0409-6
 Engine balancer 0415-1 - 0415-2
 Exhaust manifold 0410-1 - 0410-2
 Fan drive 0429-1
 Flywheel, housing and
 fastenings 0433-1 - 0433-2

Engine—Continued

| | |
|---------------------------------------|------------------|
| Fuel filter | 0420-1 - 0420-2 |
| Fuel injection system | 0413-1 - 0413-11 |
| Fuel transfer pump | 0421-1 - 0421-4 |
| Intake manifold | 0414-1 - 0414-2 |
| Oil cooler | 0419-1 - 0419-2 |
| Oiling system | 0407-1 - 0407-5 |
| Removal and installation | 0400-5 - 0400-8 |
| Starting motor and fastenings | 0422-1 - 0422-10 |
| Thermostats, housing and water piping | 0418-1 - 0418-2 |
| Turbocharger | 0416-1 - 0416-8 |
| Ventilating system | 0408-1 |
| Water pump | 0417-1 - 0417-6 |

Engine auxiliary systems:

| | |
|------------------------------|-----------------|
| Cold weather starting aids | 0505-3 - 0505-5 |
| Cooling systems | 0510-1 - 0510-3 |
| External exhaust systems | 0530-1 |
| External fuel supply systems | 0560-1 - 0560-2 |
| Intake system | 0520-1 - 0520-2 |
| Mounting frame | 0540-1 |
| Speed controls | 0515-1 - 0515-6 |

| | |
|----------------------------------|--------|
| Engine coolant temperature gauge | 1676-2 |
| Engine oil pressure gauge | 1676-3 |
| Engine side shields | 1910-5 |

Engine system testing

| | |
|-------------------------|-------------------|
| Component location | 9010-1 - 9010-14 |
| Diagnosing malfunctions | 9010-2 - 9010-4 |
| Testing and adjustments | 9010-5 - 9010-7 |
| Theory of operation | 9010-10 - 9010-14 |
| Visual inspection | 9010-1 |

| | |
|-------------------------|-----------------|
| Evaporator | 9010-8 - 9010-9 |
| Exhaust manifold | 1830-24 |
| Exhaust systems, engine | 0410-1 - 0410-2 |
| Expansion valve | 0530-1 |
| External exhaust system | 1830-25 |
| Extinguisher, fire | 0530-1 |
| | 2003-3 - 2003-4 |

F

| | |
|----------------------------------|-----------------|
| Fan drive | 0429-1 |
| Fenders | 1927-1 |
| Filter, fuel | 0420-1 - 0420-2 |
| Filters, transmission | 0360-109 |
| Fire extinguisher | 2003-3 - 2003-4 |
| Flywheel, housing and fastenings | 0433-1 - 0433-2 |

| | |
|-----------------------------------|-------------------|
| Forward and reverse speed control | 0315-6 - 0315-9 |
| Frame bottom guards | 1746-1 |
| Frame, engine mounting | 0540-1 |
| Frame, loader | 3140-1 - 3140-2 |
| Frame, main | 1740-3 - 1740-4 |
| Frame, track | 0130-33 - 0130-36 |
| Front idler | 0130-23 - 0130-28 |
| Fuel filter | 0420-1 - 0420-2 |
| Fuel injection system | 0413-1 - 0413-11 |
| Fuel injection nozzles | 0413-8 - 0413-11 |
| Fuel injection pump | 0413-1 - 0413-7 |
| Fuel tank, engine | 0560-1 - 0560-2 |
| Fuel transfer pump | 0421-1 - 0421-4 |
| Fuses | 1674-6 |

G

| | |
|-------------------------------------|-----------------|
| Gauge, engine coolant temperature | 1676-2 |
| Gauge, engine oil pressure | 1676-3 |
| Gauge, transmission oil pressure | 1676-1 |
| Gauge, transmission oil temperature | 1676-2 |
| Greases | I-V-2 |
| Grille and grille housing | 1921-1 - 1921-2 |
| Guard, frame bottom | 1746-1 |
| Guard, rock | 1913-2 |

H

| | |
|--------------------------------------|--------------------|
| Heating system | 1830-1 - 1830-3 |
| Heating system testing | 9031-1 - 9031-3 |
| High temperature switch | 1830-28 |
| Hood | 1910-3 |
| Horn | 2004-1 |
| Hour meter | 1676-4 |
| Hydraulic oil filter indicator | 1676-5 |
| Hydraulic system (analyzer) | |
| testing | 9025A-1 - 9025A-11 |
| Hydraulic system pretest check sheet | 9025A-4 |
| Operational checks | 9025A-3 |
| Pretest inspection | 9025A-3 |
| Symptom index | 9025A-5 |
| Tests | 9025A-6 - 9025A-11 |
| Hydraulic system (flow meter) | |
| testing | 9025-1 - 9025-28 |
| Component location | 9025-3 |
| Diagnosing malfunctions | 9025-21 - 9025-23 |
| Testing and adjustment | 9025-24 - 9025-28 |
| Theory of operation | 9025-5 - 9025-19 |
| Visual inspection | 9025-20 |

Hydraulic system, hydrostatic transmission 0360-1 - 0369-110

Hydraulic system, parking-emergency brakes 1160-1 - 1160-4

Hydrostatic system testing 9026-2 - 9026-155

Adjustment procedures 9026-111 - 9026-155

Automatic control valve P4 pressure adjustment 9026-131 - 9026-132

Automatic control valve variable orifice installation adjustment 9026-125 - 9026-126

Automatic control valve variable orifice pressure adjustment 9026-127 - 9026-128

Bleeding of the transmission control circuit 9026-138 - 9026-140

Brake valve cable adjustment 9026-114

Engine speed adjustment 9026-153

Engine speed and transmission control valve synchronization 9026-117 - 9026-120

FNR speed control lever linkage neutral adjustment 9026-115 - 9026-116

Initial start-up of crawler after transmission repair 9026-113

Pump displacement control valve neutral adjustment 9026-154 - 9026-155

Return-to-neutral cable adjustment 9026-148 - 9026-149

Steering linkage adjustment 9026-143 - 9026-144

Steering neutral stop adjustment 9026-145 - 9026-149

Steering valve stop adjustment on the transmission control valve 9026-141 - 9026-142

Transmission automatic control valve shutoff valve cable adjustment 9026-152

Transmission control valve P1 overpressure relief valve adjustment 9026-123

Transmission control valve P2 pressure regulating valve adjustment 9026-124

Transmission control valve P3 speed control valve adjustment 9026-129 - 9026-132

Hydrostatic system testing—Continued

Adjustment procedures—Continued

Transmission fluid heat-up procedure 9026-121

Transmission full speed adjustment 9026-135 - 9026-137

Component location 9026-36 - 9026-42

Diagnosing malfunctions 9026-43 - 9026-107

Diagnostic equipment 9026-44

Diagnostic procedures 9026-45 - 9026-72

Automatic control valve accumulator (P9 check) 9026-70 - 9026-72

Automatic control valve operational check 9026-66 - 9026-69

Engine horsepower check 9026-49 - 9026-50

Transmission charge pressure loss isolation 9026-57 - 9026-58

Transmission control system tracking check 9026-59 - 9026-65

Transmission pressures test 9026-55 - 9026-56

Transmission volumetric efficiency test 9026-51 - 9026-54

Diagnostic symptoms 9026-73 - 9026-108

Symptoms index 9026-74

General Information 9026-2 - 9026-34

Brake valve 9026-32

Hydrostatic transmission 9026-2 - 9026-17

Charge pump 9026-10

Oil cooler bypass valve 9026-33

Transmission control valve 9026-18 - 9026-32

Visual inspection 9026-34

Hydrostatic transmission 0360-1 - 0360-110

Bypass valve 0360-38 - 0369-39

Charge pump 0360-31 - 0360-32

Cleanliness 0360-2

Components 0360-1

Hydrostatic transmission sump 0360-108

Installation 0360-4

Manifold valve assembly 0360-64 - 0360-67

Motor displacement control valve 0360-61 - 0360-63

Oil cooler 0360-103

Oil cooler bypass valve 0360-104 - 0360-105

Pump displacement control valve 0360-33 - 0360-37

Removal 0360-2 - 0360-3

Repair 0360-4

Start-up procedure 0360-5

Hydrostatic transmission—Continued

| | |
|---|---------------------|
| Transmission control valve | 0360-68 - 0360-102 |
| Assembly | 0360-86 - 0360-101 |
| Automatic control valve | 0360-88 - 0360-90 |
| Automatic control valve shutoff valve | 0360-87 |
| Automatic control valve variable orifice | 0360-92 - 0360-94 |
| FNR valve | 0360-99 - 0360-100 |
| P1 over pressure relief valve | 0360-86 |
| P2 pressure regulator valve | 0360-86 |
| Port plate and cover assembly | 0360-101 |
| Speed control valve | 0360-97 - 0360-98 |
| Steering valve | 0360-95 - 0360-96 |
| Steering valve orifices | 0360-91 |
| Disassembly | 0360-70 - 0360-84 |
| Automatic control valve | 0360-73 - 0360-75 |
| Automatic control valve shutoff valve | 0360-73 |
| Automatic control valve variable orifice | 0360-76 - 0360-77 |
| FNR valve | 0360-82 - 0360-83 |
| P1 over pressure relief valve | 0360-72 |
| P2 pressure regulator valve | 0360-72 |
| Speed control valve | 0360-84 |
| Steering valve | 0360-79 - 0360-81 |
| Steering valve orifices | 0360-75 |
| Transmission control valve assembly | 0360-78 |
| Transmission filters | 0360-109 |
| Transmission motor | 0360-40 - 0360-60 |
| Transmission operating pres- sure valve | 0360-106 - 0360-107 |
| Transmission pump | 0360-6 - 0360-30 |
| Hydrostatic transmission sump | 0360-108 |

I

| | |
|---|-------------------|
| Idler, track | 0130-23 - 0130-28 |
| Input drive shafts and U-joints | 0325-1 - 0325-2 |
| Instrument panel | 1676-1 |
| Instruments and indicators | 1676-1 - 1676-6 |
| Electrical sensing gauges and indicators | 1676-4 - 1676-6 |
| Mechanical sensing gauges and indicators | 1676-1 - 1676-3 |
| Intake manifold | 0414-1 - 0414-2 |
| Intake system, engine | 0520-1 - 0520-2 |

K

| | |
|----------------------|--------|
| Key switch | 1674-3 |
|----------------------|--------|

L

| | |
|---|-------------------|
| Light switch | 1673-2 |
| Lighter, cigar | 2006-1 |
| Lights | 1673-1 |
| Loader controls linkage | 3115-1 - 3115-2 |
| Loader frames | 3140-1 - 3140-2 |
| Loader hydraulic system | 3160-1 - 3160-32 |
| Control valve | 3160-13 - 3160-21 |
| Cylinders | 3160-22 - 3160-32 |
| Hydraulic fitting installation and service recommendations | 3160-1 - 3160-3 |
| Loader pump | 3160-4 - 3160-9 |
| Oil cooler | 3160-12 |
| Reservoir and filters | 3160-10 - 3160-11 |
| Loader mast and cab cover | 1913-1 |
| Loader pump | 3160-4 - 3160-9 |
| Lubrication | I-V-1 - I-V-2 |

M

| | |
|---|-------------------|
| Main bearings and crankshaft | 0401-1 - 0401-7 |
| Main frame | 1740-3 - 1740-4 |
| Malfunions, diagnosing: | |
| Air conditioning system | 9031-8 |
| Electrical system | 9015-8 - 9015-10 |
| Engine system | 9010-5 - 9010-7 |
| Heating system | 9031-1 |
| Hydraulic system (flow meter) | 9025-21 - 9025-23 |
| Power train system | 9020-10 - 9020-11 |
| Track | 9030-1 |
| Manifold, exhaust | 0410-1 - 0410-2 |
| Manifold, intake | 0414-1 - 0414-2 |
| Manifold valve assembly | 0360-64 - 0360-67 |
| Mechanical sensing gauges and indicators | 1676-1 - 1676-3 |
| Motor, Delco-Remy starting | 0422-1 - 0422-10 |
| Motor displacement control valve | 0360-61 - 0360-63 |
| Motor, transmission | 0360-40 - 0360-60 |
| Mounting frame, engine | 0540-1 |
| Muffler | 0530-1 |

N

Nozzle, fuel injection 0413-8 - 0413-11

O

Oil cooler bypass valve 0360-104 - 0360-105
Oil cooler, engine 0419-1 - 0419-2
Oil cooler, loader 3160-12
Oil cooler, transmission 0360-103
Oiling system, engine 0407-1 - 0407-5
Oils I-V-2

P

Parking-emergency brakes:
Active elements 1111-3 - 1111-5
Controls linkage 1115-1 - 1115-2
Hydraulic system 1160-1 - 1160-4
Pistons and connecting rods 0403-1 - 0403-6
Power train system testing 9020-1 - 9020-12
Adjustment 9020-12
Block diagram 9020-9
Component location 9020-2 - 9020-3
Diagnosing malfunctions 9020-10 - 9020-11
Parking brake and final
drive cross section 9020-8
Theory of operation 9020-5 - 9020-7
Visual inspection 9020-11
Predelivery service I-IV-1 - I-IV-15
Air cleaner I-IV-1
Air intake hose I-IV-2
Alternator - fan compressor
belt tension I-IV-6 - I-IV-7
Batteries I-IV-2
Crankcase oil level I-IV-3
Engine speeds I-IV-7 - I-IV-10
Final check I-IV-15
Final drive housing oil level I-IV-5
Fuel filters I-IV-2
Fuel tank I-IV-2
Fuel tank sump I-IV-3
Hardware torque valves I-IV-15
Hydraulic brake (park brake) I-IV-13
Hydraulic oil level I-IV-6
Hydrostatic transmission oil
level I-IV-5
Injection pump I-IV-14
Indicator lights and gauges I-IV-11 - I-IV-12
Lights I-IV-12 - I-IV-13
Lubrication I-IV-14

Predelivery service—Continued

Neutral lock lever operation I-IV-14
Radiator I-IV-3
Seat operation I-IV-10
Splitter gearbox oil level I-IV-4
Steering I-IV-13
Track rollers, upper idlers
and front idler oil levels I-IV-4
Track tension adjustment I-IV-10
Transmission shifting I-IV-13
PTO cover 4041-3
Pump displacement control valve 0360-33 - 0360-37
Pump, engine oil 0407-1 - 0407-4
Pump, engine water 0417-1 - 0417-6
Pump, fuel injection 0413-1 - 0413-7
Pump, fuel transfer 0421-1 - 0421-4
Pump, loader 3160-4 - 3160-9
Pump, transmission 0360-6 - 0360-30
Pump, transmission charge 0360-31 - 0360-32

R

Radiator 0510-1 - 0510-3
Receiver-dryer 1830-22
Recoil spring 0130-31 - 0130-33
Relays 1674-4
Reservoir and filters, loader 3160-10 - 3160-11
Return-to-dig function 1675-1 - 1675-2
Return to neutral linkage 0315-14
Reverse warning alarm 2004-2
Rock guards 1913-2
Rock guards and track guides 0130-3
Rocker arm assembly 0402-2, 0402-3,
0409-2
Roller, track 0130-8 - 0130-11
ROPS, windshield (without cab) 1810-6
ROPS, without cab 1810-7

S

Safety information I-II-1 - I-II-7
Seat 1821-1 - 1821-5
Service, delivery I-IV-16
Shield, brush 1910-6
Shield, engine side 1910-5
Shoe, track 0130-12
Side shields, engine 1910-5

Special tools:

| | |
|--|-------------------|
| Air conditioning system | 1899-3 - 1899-4 |
| Alternator, regulator and charging system wiring | 1699-8 - 1699-9 |
| Batteries, support and cables | 1699-7 |
| Camshaft and valve actuating means | 0499-28 - 0499-29 |
| Clutch disconnect and controls | 0399-21 |
| Connecting rods and pistons | 0499-30 |
| Crankshaft and main bearings | 0499-27 |
| Cylinder block | 0499-31 |
| Cylinder head and valves | 0499-32 - 0499-33 |
| Drive axle housing and support | 0299-5 - 0299-6 |
| Electrical system testing | 9035-11 |
| Engine removal and installation | 0499-26 |
| Engine system testing | 9035-3 - 9035-5 |
| Fuel injection system | 0499-34 - 0499-36 |
| Heating and air conditioning system testing | 9035-21 |
| Hydraulic system | 0399-15 - 0399-20 |
| Hydraulic system testing | 9035-15 - 9035-16 |
| Hydrostatic system testing | 9035-19 |
| Loader frames | 3199-5 |
| Starting motor and fastenings | 0499-39 - 0499-40 |
| Track systems | 0199-6 - 0199-8 |
| Transfer drive gears shafts, bearings | 0899-2 |
| Turbocharger | 0499-37 |
| Water pump | 0499-38 |

Specifications and torque values

| | |
|--|-------------------|
| Air conditioning system | 1899-1 - 1899-2 |
| Alternator and generator mounting | 0499-24 |
| Alternator, regulator and charging system wiring | 1699-1 - 1699-5 |
| Axle shaft, bearings and reduction gears | 0299-2 - 0299-5 |
| Batteries, support and cables | 1699-1 |
| Camshaft and valve actuating means | 0499-5 - 0499-7 |
| Center frame | 1799-1 |
| Clutch disconnect and controls | 0399-14 |
| Connecting rods and pistons | 0499-8 - 0499-9 |
| Controls | 0399-1 |
| Cooling systems, engine | 0599-1 |
| Crankshaft and main bearings | 0499-3 - 0499-4 |
| Cylinder block | 0499-10 - 0499-11 |
| Cylinder head and valves | 0499-13 - 0499-17 |
| Drive axle housing and support | 0299-1 |
| Electrical system testing | 9035-6 - 9035-10 |
| Engine break-in | 0499-1 |

Specifications and torque values—Continued

| | |
|---|-------------------|
| Engine oiling system | 0499-12 - 0499-13 |
| Engine removal and installation | 0499-2 |
| Engine system testing | 9035-1 - 9035-2 |
| Exhaust manifold | 0499-16 |
| External exhaust system | 0599-1 |
| External fuel supply system, engine | 0599-1 |
| Fan drive | 0499-25 |
| Flywheel, housing and fastenings | 0499-25 |
| Fuel filter | 0499-26 |
| Fuel injection system | 0499-17 - 0499-18 |
| Fuel transfer pump | 0499-21 |
| General | I-III-1 - I-III-4 |
| Blade | I-III-2 |
| Brakes | I-III-1 |
| Capacities | I-III-2 |
| Drawbar pull | I-III-1 |
| Engine | I-III-1 |
| Hydraulic cylinders | I-III-2 |
| Hydraulic system | I-III-1 |
| Loader dimensions | I-III-3 |
| Operating information | I-III-4 |
| Power | I-III-1 |
| Special equipment | I-III-2 |
| Standard equipment | I-III-2 |
| Steering | I-III-1 |
| Tracks | I-III-2 |
| Transmission | I-III-1 |
| Heating and air conditioning system testing | 9035-20 |
| Hydraulic system | 0399-3 - 0399-13 |
| Hydraulic system (analyzer) testing | 9035-14 |
| Hydraulic system (flow meter) testing | 9035-13 |
| Hydrostatic system testing | 9035-17 - 9035-18 |
| Input drive shafts and U-joints | 0399-2 |
| Instruments and Indicators | 1699-6 |
| Intake manifold | 0499-17 |
| Lighting system | 1699-5 |
| Loader hydraulic system | 3199-1 - 3199-4 |
| Miscellaneous components system testing | 9035-22 - 9035-23 |
| Mounting frame, engine | 0599-1 |
| Oil cooler | 0499-21 |
| Parking-emergency brakes active elements | 1199-1 |
| Parking-emergency brakes hydraulic system | 1199-2 |

Specifications and torque values—Continued

| | |
|---|-------------------|
| Power train system testing | 9035-12 |
| Speed controls, engine | 0599-1 |
| Starting motor and fastenings | 0499-22 - 0499-24 |
| Thermostats, housings and water piping | 0499-20 |
| Track systems | 0199-1 - 0199-5 |
| Transfer drive gears, shafts, bearings | 0899-1 - 0899-2 |
| Turbocharger | 0499-21 - 0499-23 |
| Water pump | 0499-23 - 0499-24 |
| Wiring harness and switches | 1699-6 |
| Speed control, forward and reverse | 0315-6 - 0315-9 |
| Components | 0315-9 |
| Speed control support | 0315-12 |
| Speed controls, engine | 0515-1 - 0515-6 |
| Splitter housing: | |
| Gears, shafts, bearings | 0851-1 - 0851-7 |
| Housings and covers | 0841-3 - 0841-4 |
| Sprocket | 0130-37 - 0130-38 |
| Start safety switch | 1674-2 |
| Start-up procedure, transmission | 0360-5 |
| Starter switch | 1674-3 |
| Starting aids, cold weather | 0505-3 - 0505-5 |
| Starting circuit relay | 1674-4 |
| Starting motor and fastenings | 0422-1 - 0422-10 |
| Assembly | 0422-9 - 0422-10 |
| Components | 0422-5 - 0422-6 |
| Installation | 0422-10 |
| Operational theory | 0422-1 - 0422-2 |
| Repair | 0422-5 - 0422-9 |
| Testing solenoid | 0422-3 - 0422-4 |
| Steering linkage | 0315-3 - 0315-5 |
| Storage of crawler | I-IV-1 |
| Sump, hydrostatic transmission | 0360-108 |
| Superheat shut-off switch | 1830-27 |
| Switch, battery disconnect | 1674-2 |
| Switch, high temperature | 1830-28 |
| Switch, key | 1674-3 |
| Switch, light | 1673-2 |
| Switch, start safety | 1674-2 |
| Switch, starter | 1674-3 |
| Switch, starting aid | 0505-4 |
| Switch, superheat shut-off | 1830-27 |
| Switch, thermostatic temperature control | 1830-25 - 1830-26 |
| Switch, wiper | 1674-3 |

T

Tests and adjustments:

| | |
|--|-------------------|
| Air conditioning system | 9031-12 - 9031-19 |
| Adding Refrigerant-12 to system | 9031-18 |
| Charging system | 9031-16 - 9031-17 |
| Discharging System | 9031-14 |
| Electrical testing | 9031-14 |
| Evacuating system | 9031-15 |
| Flushing system components | 9031-19 |
| Inspecting refrigerant hoses and tubing | 9031-19 |
| Leak testing | 9031-19 |
| Operational test | 9031-14 |
| Pressure gauges | 9031-12 - 9031-13 |
| Alternator, 16 amp | 1672-5 - 1672-11 |
| Alternator, 50 amp | 1672-19 - 1672-21 |
| Battery | 1671-5 - 1671-6 |
| Battery voltage test | 9015-13 |
| High-rate discharge test | 1671-6 |
| Specific gravity cell compar- ison test | 1671-5 |
| Compressor leak testing | 1830-18 - 1830-19 |
| Discharge to suction side leak test | 1830-19 |
| Shaft seal leak test | 1830-18 |
| Electrical system | 9015-13 - 9015-30 |
| Accessory circuits | 9015-25 - 9015-30 |
| Batteries | 9015-13 |
| Charging circuit - 16 amp alternator | 9015-20 - 9015-22 |
| Charging circuit - 50 amp alternator | 9015-23 - 9015-25 |
| Starting circuit | 9015-14 - 9015-19 |
| System short test | 9015-13 |
| Engine system | 9010-10 - 9010-14 |
| Air restriction indicator test | 9010-14 |
| Alternator and fan belt adjustments | 9010-12 |
| Aneroid adjustments | 9010-14 |
| Compression pressure test | 9010-10 |
| Engine oil pressure check | 9010-10 |
| Engine output check | 9010-10 - 9010-11 |
| Fuel transfer pump pressure test | 9010-12 |
| Intake manifold pressure test | 9010-14 |
| Radiator leakage check | 9010-11 |
| Speed control adjustment | 9010-13 |
| Heating system | 9031-1 - 9031-3 |

Tests and adjustment—Continued

Hydraulic system (analyzer) . 9025A-6 - 9025A-12
Cylinder leakage test 9025A-10
Function leakage test 9025A-8 - 9025A-10
Hydraulic pump test 9025A-7 - 9025A-8
Parts list for tests 9025A-11
System relief valve test 9025A-6 - 9025A-7
Hydraulic system (flow meter) 9025-23 - 9025-28
Auxiliary control valve lift check test . . . 9025-25
Boom control valve lift check test 9025-25
Bucket control valve lift check test 9025-25
Hydraulic cylinder leakage test 9025-24
Hydraulic pump flow test 9025-26 - 9025-27
Hydraulic sump check 9025-24
Loader circuit leakage check 9025-25
Oil lines and hoses check 9025-24
System relief pressure setting
check 9025-24
Power train 9020-12
Engine disconnect clutch 9020-12
Track adjustment 9030-2 - 9030-3
Front idler gears 9030-3
Inner guide adjustment 9030-3
Outer guide adjustment 9030-3
Track tension 9030-2
Turbocharger 0416-2
Axial end play bearing test 0416-2
Radial bearing movement 0416-2
Thermal fuse 1830-27
Thermostatic temperature control
switch 1830-25 - 1830-26
Thermostats, housing and water
piping 0418-1 - 0418-2
Towbar 1512-1
Track systems 0130-3 - 0130-38
Carrier rollers 0130-4 - 0130-7
Front idler 0130-23 - 0130-28
Recoil spring 0130-31 - 0130-33
Rock guards and track guides 0130-3
Sprocket 0130-37 - 0130-38
Track adjuster cylinder 0130-29 - 0130-31
Track chain assembly 0130-13 - 0130-22
Track frame 0130-33 - 0130-36
Track rollers 0130-8 - 0130-11
Track shoes 0130-12
Track testing 9030-1 - 9030-3
Adjustment 9030-2 - 9030-3
Transfer drive:
Gears, shafts, bearings 0851-1 - 0851-7
Housings and covers 0841-3 - 0841-4

Transmission control valve 0360-68 - 0360-102
Assembly 0360-86 - 0360-101
Automatic control valve 0360-88 - 0360-90
Automatic control valve
shutoff valve 0360-87
Automatic control valve
variable orifice 0360-92 - 0360-94
FNR valve 0360-99 - 0360-100
P1 over pressure relief valve 0360-86
P2 pressure regulator valve 0360-86
Port plate and cover
assembly 0360-101
Speed control valve 0360-97 - 0360-98
Steering valve 0360-95 - 0360-96
Steering valve orifices 0360-91
Disassembly 0360-70 - 0360-84
Automatic control valve 0360-73 - 0360-75
Automatic control valve
shutoff valve 0360-73
Automatic control valve
variable orifice 0360-76 - 0360-77
FNR valve 0360-82 - 0360-83
P1 over pressure relief valve 0360-72
P2 pressure regulator valve 0360-72
Speed control valve 0360-84
Steering valve 0360-79 - 0360-81
Steering valve orifices 0360-75
Transmission control valve
assembly 0360-78
Transmission controls 0315-3 - 0315-14
Automatic control valve shut-
off valve control 0315-13 - 0315-14
Return to neutral linkage 0315-14
Automatic control valve variable
orifice linkage 0315-10 - 0315-11
Components 0315-10
Forward and reverse speed
control 0315-6 - 0315-9
Components 0315-6
Control head 0315-7 - 0315-8
Components 0315-9
Speed control support 0315-12
Steering linkage 0315-3 - 0315-5
Transmission filters 0360-109
Transmission motor 0360-40 - 0360-60
Transmission oil filter indicator 1676-5
Transmission oil pressure gauge 1676-1
Transmission oil temperature gauge 1676-2
Transmission operating pres-
sure valve 0360-106 - 0360-107
Transmission pump 0360-6 - 0360-30
Turbocharger 0416-1 - 0416-8

V

Vacuum relief valve 0360-110
Valve, brake 1160-1 - 1160-4
Valve, compressor relief 1830-26
Valve, double selector 4260-1
Valve, expansion 1830-24
Valve, loader control 3160-13 - 3160-17
Valve, manifold transmission 0360-64 - 0360-67
Valve, motor displacement
control 0360-61 - 0360-63
Valve, oil cooler bypass 0360-104 - 0360-105
Valve, pump displacement control
valve 0360-33 - 0360-37
Valve, transmission bypass 0360-38 - 0360-39
Valve, transmission control 0360-68 - 0360-102
Assembly 0360-86 - 0360-101
Automatic control valve 0360-88 - 0360-90
Automatic control valve
shutoff valve 0360-87
Automatic control valve
variable orifice 0360-92 - 0360-94
FNR valve 0360-99 - 0360-100
P1 over pressure relief valve 0360-86
P2 pressure regulator valve 0360-86
Port plate and cover assembly 0360-101
Speed control valve 0360-97 - 0360-98
Steering valve 0360-95 - 0360-96
Steering valve orifices 0360-91
Disassembly 0360-70 - 0360-84
Automatic control valve 0360-73 - 0360-75
Automatic control valve
shutoff valve 0360-73
Automatic control valve
variable orifice 0360-76 - 0360-77
FNR valve 0360-82 - 0360-83
P1 over pressure relief valve 0360-72
P2 pressure regulator valve 0360-72
Speed control valve 0360-84
Steering valve 0360-79 - 0360-81
Steering valve orifices 0360-75
Transmission control valve
assembly 0360-78
Valve, transmission operating
pressure 0360-106 - 0360-107
Valve, vacuum relief 0360-110
Valves and cylinder head, engine .. 0409-1 - 0409-6
Ventilating system, engine 0408-1
Vibration damper 0415-1 - 0415-2
Voltmeter 1676-4

W

Water manifold 0418-1 - 0418-2
Water pump, engine 0417-1 - 0417-6
Windshield, ROPS without cab 1810-6
Windshield washer 1810-9 - 1810-10
Windshield wiper, front 1810-8
Windshield wiper, rear 1810-9
Wiper switch 1674-3
Wiring harness 1674-1





**COMPLETE PAGE LISTING
 WITH LATEST DATE LINES**

| | | | | | |
|--------------|----------|--------------|----------|----------------|----------|
| I-I-1,2 | (May-78) | 1-0130-29,30 | (May-78) | 3-0360-35,36 | (May-78) |
| I-I-3,4 | (May-78) | 1-0130-31,32 | (May-79) | 3-0360-37,38 | (May-78) |
| I-I-5,6 | (May-78) | 1-0130-33,34 | (May-79) | 3-0360-39,40 | (May-78) |
| I-I-7,8 | (May-79) | 1-0130-35,36 | (May-79) | 3-0360-41,42 | (May-78) |
| I-I-9,10 | (May-79) | 1-0130-37,38 | (May-79) | 3-0360-43,44 | (May-78) |
| I-I-11,12 | (May-79) | 1-0199-1,2 | (May-79) | 3-0360-45,46 | (May-78) |
| I-I-13,14 | (May-79) | 1-0199-3,4 | (May-79) | 3-0360-47,48 | (May-78) |
| I-I-15,16 | (May-79) | 1-0199-5,6 | (May-78) | 3-0360-49,50 | (May-79) |
| I-I-17,18 | (May-79) | 1-0199-7,8 | (May-78) | 3-0360-51,52 | (May-78) |
| I-I-19,20 | (May-79) | | | 3-0360-53,54 | (May-79) |
| I-I-21,22 | (May-79) | 2-0201-1,2 | (May-79) | 3-0360-55,56 | (May-78) |
| I-I-23,24 | (May-79) | 2-0201-3,4 | (May-78) | 3-0360-57,58 | (May-78) |
| I-I-25,26* | (May-78) | 2-0201-5,6 | (May-79) | 3-0360-59,60 | (May-79) |
| I-I-27,28* | (May-78) | 2-0250-1,2 | (May-78) | 3-0360-61,62 | (May-78) |
| I-I-29,30* | (May-78) | 2-0250-3,4 | (May-78) | 3-0360-63,64 | (May-78) |
| I-I-31,32* | (May-78) | 2-0250-5,6 | (May-78) | 3-0360-65,66 | (May-78) |
| I-II-1,2 | (May-78) | 2-0250-7,8 | (May-78) | 3-0360-67,68 | (May-78) |
| I-II-3,4 | (May-78) | 2-0250-9,10 | (May-78) | 3-0360-69,70 | (May-78) |
| I-II-5,6 | (May-78) | 2-0250-11,12 | (May-79) | 3-0360-71,72 | (May-78) |
| I-II-7,8 | (May-78) | 2-0250-13,14 | (May-79) | 3-0360-73,74 | (May-78) |
| I-III-1,2 | (May-78) | 2-0250-15,16 | (May-78) | 3-0360-75,76 | (May-79) |
| I-III-3,4 | (May-78) | 2-0250-17,18 | (May-79) | 3-0360-77,78 | (May-79) |
| I-IV-1,2 | (May-78) | 2-0250-19,20 | (May-79) | 3-0360-79,80 | (May-78) |
| I-IV-3,4 | (May-78) | 2-0299-1,2 | (May-78) | 3-0360-81,82 | (May-79) |
| I-IV-5,6 | (May-78) | 2-0299-3,4 | (May-78) | 3-0360-83,84 | (May-79) |
| I-IV-7,8 | (May-78) | 2-0299-5,6 | (May-78) | 3-0360-85,86 | (May-79) |
| I-IV-9,10 | (May-78) | | | 3-0360-87,88 | (May-78) |
| I-IV-11,12 | (May-78) | 3-0315-1,2 | (May-79) | 3-0360-89,90 | (May-78) |
| I-IV-13,14 | (May-78) | 3-0315-3,4 | (May-78) | 3-0360-91,92 | (May-79) |
| I-IV-15,16 | (May-78) | 3-0315-5,6 | (May-78) | 3-0360-93,94 | (May-79) |
| I-IV-17,18 | (May-78) | 3-0315-7,8 | (May-79) | 3-0360-95,96 | (May-78) |
| I-IV-19,20 | (May-78) | 3-0315-9,10 | (May-78) | 3-0360-97,98 | (May-78) |
| I-IV-21,22 | (May-79) | 3-0315-11,12 | (May-78) | 3-0360-99,100 | (May-79) |
| I-IV-23,24 | (May-79) | 3-0315-13,14 | (May-78) | 3-0360-101,102 | (May-78) |
| I-IV-25,26 | (May-78) | 3-0325-1,2 | (May-78) | 3-0360-103,104 | (May-78) |
| I-IV-27,28 | (May-78) | 3-0360-1,2 | (May-78) | 3-0360-105,106 | (May-78) |
| I-V-1,2 | (May-78) | 3-0360-3,4 | (May-79) | 3-0360-107,108 | (May-78) |
| | | 3-0360-5,6 | (May-79) | 3-0360-109,110 | (May-79) |
| 1-0130-1,2 | (May-78) | 3-0360-7,8 | (May-78) | 3-0370-1,2 | (May-78) |
| 1-0130-3,4 | (May-78) | 3-0360-9,10 | (May-78) | 3-0370-3,4 | (May-78) |
| 1-0130-5,6 | (May-78) | 3-0360-11,12 | (May-78) | 3-0370-5,6 | (May-78) |
| 1-0130-7,8 | (May-79) | 3-0360-13,14 | (May-78) | 3-0399-1,2 | (May-78) |
| 1-0130-9,10 | (May-78) | 3-0360-15,16 | (May-79) | 3-0399-3,4 | (May-78) |
| 1-0130-11,12 | (May-79) | 3-0360-17,18 | (May-78) | 3-0399-5,6 | (May-78) |
| 1-0130-13,14 | (May-78) | 3-0360-19,20 | (May-79) | 3-0399-7,8 | (May-78) |
| 1-0130-15,16 | (May-78) | 3-0360-21,22 | (May-78) | 3-0399-9,10 | (May-78) |
| 1-0130-17,18 | (May-78) | 3-0360-23,24 | (May-78) | 3-0399-11,12 | (May-78) |
| 1-0130-19,20 | (May-78) | 3-0360-25,26 | (May-78) | 3-0399-13,14 | (May-78) |
| 1-0130-21,22 | (May-78) | 3-0360-27,28 | (May-78) | 3-0399-15,16 | (May-78) |
| 1-0130-23,24 | (May-79) | 3-0360-29,30 | (May-79) | 3-0399-17,18 | (May-78) |
| 1-0130-25,26 | (May-78) | 3-0360-31,32 | (May-79) | 3-0399-19,20 | (May-79) |
| 1-0130-27,28 | (May-79) | 3-0360-33,34 | (May-78) | 3-0399-21,22 | (May-78) |

Vertical lines indicate pages included in this revision.

*Remove these pages from manual.

| | | | | | |
|--------------|----------|---------------|----------|---------------|----------|
| 4-0400-1,2 | (May-79) | 4-0421-1,2 | (May-79) | 8-0851-3,4 | (May-78) |
| 4-0400-3,4 | (May-79) | 4-0421-3,4 | (May-79) | 8-0851-5,6 | (May-79) |
| 4-0400-5,6 | (May-79) | 4-0422-1,2 | (May-79) | 8-0851-7,8 | (May-79) |
| 4-0400-7,8 | (May-79) | 4-0422-3,4 | (May-79) | 8-0899-1,2 | (May-79) |
| 4-0401-1,2 | (May-79) | 4-0422-5,6 | (May-79) | | |
| 4-0401-3,4 | (May-79) | 4-0422-7,8 | (May-79) | 11-1111-1,2 | (May-78) |
| 4-0401-5,6 | (May-79) | 4-0422-9,10 | (May-79) | 11-1111-3,4 | (May-78) |
| 4-0401-7,8 | (May-79) | 4-0423-1,2 | (May-79) | 11-1111-5,6 | (May-78) |
| 4-0402-1,2 | (May-79) | 4-0429-1,2 | (May-79) | 11-1115-1,2 | (May-78) |
| 4-0402-3,4 | (May-79) | 4-0433-1,2 | (May-79) | 11-1160-1,2 | (May-79) |
| 4-0402-5,6 | (May-79) | 4-0499-1,2 | (May-79) | 11-1160-3,4 | (May-78) |
| 4-0403-1,2 | (May-79) | 4-0499-3,4 | (May-79) | 11-1199-1,2 | (May-78) |
| 4-0403-3,4 | (May-79) | 4-0499-5,6 | (May-79) | | |
| 4-0403-5,6 | (May-79) | 4-0499-7,8 | (May-79) | 15-1511-1,2 | (May-78) |
| 4-0403-7,8 | (May-79) | 4-0499-9,10 | (May-79) | 15-1511-3,4 | (May-78) |
| 4-0404-1,2 | (May-79) | 4-0499-11,12 | (May-79) | 15-1512-1,2 | (May-78) |
| 4-0404-3,4 | (May-79) | 4-0499-13,14 | (May-79) | | |
| 4-0404-5,6 | (May-79) | 4-0499-15,16 | (May-79) | 16-1671-1,2 | (May-79) |
| 4-0404-7,8 | (May-79) | 4-0499-17,18 | (May-79) | 16-1671-3,4 | (May-78) |
| 4-0404-9,10 | (May-79) | 4-0499-19,20 | (May-79) | 16-1671-5,6 | (May-79) |
| 4-0407-1,2 | (May-79) | 4-0499-21,22 | (May-79) | 16-1671-7,8 | (May-78) |
| 4-0407-3,4 | (May-79) | 4-0499-23,24 | (May-79) | 16-1672-1,2 | (May-78) |
| 4-0408-1,2 | (May-79) | 4-0499-25,26 | (May-79) | 16-1672-3,4 | (May-78) |
| 4-0409-1,2 | (May-79) | 4-0499-27,28 | (May-79) | 16-1672-5,6 | (May-78) |
| 4-0409-3,4 | (May-79) | 4-0499-29,30 | (May-79) | 16-1672-7,8 | (May-78) |
| 4-0409-5,6 | (May-79) | 4-0499-31,32 | (May-79) | 16-1672-9,10 | (May-78) |
| 4-0410-1,2 | (May-79) | 4-0499-33,34 | (May-79) | 16-1672-11,12 | (May-78) |
| 4-0413-1,2 | (May-79) | 4-0499-35,36 | (May-79) | 16-1672-13,14 | (May-78) |
| 4-0413-3,4 | (May-79) | 4-0499-37,38 | (May-79) | 16-1672-15,16 | (May-78) |
| 4-0413-5,6 | (May-79) | 4-0499-39,40 | (May-79) | 16-1672-17,18 | (May-78) |
| 4-0413-7,8 | (May-79) | 4-0499-41,42* | (May-78) | 16-1672-19,20 | (May-78) |
| 4-0413-9,10 | (May-79) | 4-0499-43,44* | (May-78) | 16-1672-21,22 | (May-78) |
| 4-0413-11,12 | (May-79) | | | 16-1672-23,24 | (May-78) |
| 4-0413-13,14 | (May-79) | 5-0505-1,2 | (May-78) | 16-1672-25,26 | (May-78) |
| 4-0413-15,16 | (May-79) | 5-0505-3,4 | (May-78) | 16-1673-1,2 | (May-78) |
| 4-0413-17,18 | (May-79) | 5-0505-5,6 | (May-78) | 16-1674-1,2 | (May-78) |
| 4-0413-19,20 | (May-79) | 5-0510-1,2 | (May-78) | 16-1674-3,4 | (May-79) |
| 4-0414-1,2 | (May-79) | 5-0510-3,4 | (May-79) | 16-1674-5,6 | (May-78) |
| 4-0415-1,2* | (May-78) | 5-0515-1,2 | (May-78) | 16-1675-1,2 | (May-78) |
| 4-0416-1,2 | (May-79) | 5-0515-3,4 | (May-78) | 16-1675-3,4 | (May-79) |
| 4-0416-3,4 | (May-79) | 5-0515-5,6 | (May-78) | 16-1676-1,2 | (May-78) |
| 4-0416-5,6 | (May-79) | 5-0520-1,2 | (May-78) | 16-1676-3,4 | (May-78) |
| 4-0416-7,8 | (May-79) | 5-0530-1,2 | (May-79) | 16-1676-5,6 | (May-79) |
| 4-0417-1,2 | (May-79) | 5-0540-1,2 | (May-78) | 16-1699-1,2 | (May-78) |
| 4-0417-3,4 | (May-79) | 5-0560-1,2 | (May-78) | 16-1699-3,4 | (May-78) |
| 4-0417-5,6 | (May-79) | 5-0599-1,2 | (May-79) | 16-1699-5,6 | (May-79) |
| 4-0418-1,2 | (May-79) | | | 16-1699-7,8 | (May-79) |
| 4-0419-1,2 | (May-79) | 8-0841-1,2 | (May-79) | 16-1699-9,10 | (May-79) |
| 4-0420-1,2 | (May-79) | 8-0841-3,4 | (May-79) | | |
| | | 8-0851-1,2 | (May-78) | | |

Vertical lines indicate pages included in this revision.
 *Remove these pages from manual.

| | | | | | |
|---------------|----------|---------------|----------|----------------|----------|
| 17-1740-1,2 | (May-78) | 31-3160-11,12 | (May-78) | 90-9020-9,10 | (May-78) |
| 17-1740-3,4 | (May-78) | 31-3160-13,14 | (May-78) | 90-9020-11,12 | (May-78) |
| 17-1746-1,2 | (May-78) | 31-3160-15,16 | (May-79) | 90-9025-1,2 | (May-78) |
| 17-1749-1,2 | (May-79) | 31-3160-17,18 | (May-78) | 90-9025-3,4 | (May-78) |
| | | 31-3160-19,20 | (May-79) | 90-9025-5,6 | (May-78) |
| 18-1810-1,2 | (May-78) | 31-3160-21,22 | (May-78) | 90-9025-7,8 | (May-78) |
| 18-1810-3,4 | (May-78) | 31-3160-23,24 | (May-78) | 90-9025-9,10 | (May-78) |
| 18-1810-5,6 | (May-78) | 31-3160-25,26 | (May-78) | 90-9025-11,12 | (May-78) |
| 18-1810-7,8 | (May-79) | 31-3160-27,28 | (May-78) | 90-9025-13,14 | (May-78) |
| 18-1810-9,10 | (May-78) | 31-3160-29,30 | (May-78) | 90-9025-15,16 | (May-79) |
| 18-1821-1,2 | (May-78) | 31-3160-31,32 | (May-78) | 90-9025-17,18 | (May-78) |
| 18-1821-3,4 | (May-78) | 31-3199-1,2 | (May-78) | 90-9025-19,20 | (May-79) |
| 18-1821-5,6 | (May-78) | 31-3199-3,4 | (May-79) | 90-9025-21,22 | (May-78) |
| 18-1830-1,2 | (May-78) | 31-3199-5,6 | (May-79) | 90-9025-23,24 | (May-79) |
| 18-1830-3,4 | (May-79) | | | 90-9025-25,26 | (May-78) |
| 18-1830-5,6 | (May-78) | 40-4041-1,2 | (May-78) | 90-9025-27,28 | (May-78) |
| 18-1830-7,8 | (May-78) | 40-4041-3,4 | (May-78) | 90-9025A-1,2 | (May-78) |
| 18-1830-9,10 | (May-78) | | | 90-9025A-3,4 | (May-78) |
| 18-1830-11,12 | (May-78) | 42-4215-1,2 | (May-78) | 90-9025A-5,6 | (May-78) |
| 18-1830-13,14 | (May-78) | 42-4215-3,4 | (May-78) | 90-9025A-7,8 | (May-79) |
| 18-1830-15,16 | (May-78) | 42-4260-1,2 | (May-78) | 90-9025A-9,10 | (May-79) |
| 18-1830-17,18 | (May-79) | | | 90-9025A-11,12 | (May-78) |
| 18-1830-19,20 | (May-79) | 90-9005-1,2 | (May-78) | 90-9026-1,2 | (May-78) |
| 18-1830-21,22 | (May-79) | 90-9005-3,4 | (May-78) | 90-9026-3,4 | (May-78) |
| 18-1830-23,24 | (May-79) | 90-9010-1,2 | (May-78) | 90-9026-5,6 | (May-78) |
| 18-1830-25,26 | (May-79) | 90-9010-3,4 | (May-78) | 90-9026-7,8 | (May-78) |
| 18-1830-27,28 | (May-79) | 90-9010-5,6 | (May-78) | 90-9026-9,10 | (May-78) |
| 18-1830-29,30 | (May-79) | 90-9010-7,8 | (May-78) | 90-9026-11,12 | (May-78) |
| 18-1830-31,32 | (May-79) | 90-9010-9,10 | (May-78) | 90-9026-13,14 | (May-78) |
| 18-1899-1,2 | (May-79) | 90-9010-11,12 | (May-79) | 90-9026-15,16 | (May-79) |
| 18-1899-3,4 | (May-79) | 90-9010-13,14 | (May-79) | 90-9026-17,18 | (May-78) |
| | | 90-9010-15,16 | (May-79) | 90-9026-19,20 | (May-79) |
| 19-1910-1,2 | (May-78) | 90-9015-1,2 | (May-78) | 90-9026-21,22 | (May-78) |
| 19-1910-3,4 | (May-79) | 90-9015-3,4 | (May-78) | 90-9026-23,24 | (May-78) |
| 19-1910-5,6 | (May-78) | 90-9015-5,6 | (May-78) | 90-9026-25,26 | (May-78) |
| 19-1913-1,2 | (May-78) | 90-9015-7,8 | (May-78) | 90-9026-27,28 | (May-78) |
| 19-1921-1,2 | (May-78) | 90-9015-9,10 | (May-78) | 90-9026-29,30 | (May-78) |
| 19-1927-1,2 | (May-78) | 90-9015-11,12 | (May-78) | 90-9026-31,32 | (May-78) |
| | | 90-9015-13,14 | (May-78) | 90-9026-33,34 | (May-78) |
| 20-2003-1,2 | (May-78) | 90-9015-15,16 | (May-78) | 90-9026-35,36 | (May-78) |
| 20-2003-3,4 | (May-78) | 90-9015-17,18 | (May-78) | 90-9026-37,38 | (May-78) |
| 20-2004-1,2 | (May-78) | 90-9015-19,20 | (May-78) | 90-9026-39,40 | (May-78) |
| 20-2006-1,2 | (May-78) | 90-9015-21,22 | (May-78) | 90-9026-41,42 | (May-78) |
| | | 90-9015-23,24 | (May-78) | 90-9026-43,44 | (May-79) |
| 31-3102-1,2 | (May-78) | 90-9015-25,26 | (May-78) | 90-9026-45,46 | (May-78) |
| 31-3102-3,4 | (May-78) | 90-9015-27,28 | (May-78) | 90-9026-47,48 | (May-78) |
| 31-3115-1,2 | (May-79) | 90-9015-29,30 | (May-78) | 90-9026-49,50 | (May-79) |
| 31-3140-1,2 | (May-79) | 90-9015-31,32 | (May-78) | 90-9026-51,52 | (May-78) |
| 31-3160-1,2 | (May-78) | 90-9020-1,2 | (May-78) | 90-9026-53,54 | (May-79) |
| 31-3160-3,4 | (May-79) | 90-9020-3,4 | (May-78) | 90-9026-55,56 | (May-79) |
| 31-3160-5,6 | (May-78) | 90-9020-5,6 | (May-78) | 90-9026-57,58 | (May-79) |
| 31-3160-7,8 | (May-78) | 90-9020-7,8 | (May-78) | 90-9026-59,60 | (May-78) |
| 31-3160-9,10 | (May-78) | | | | |

Vertical lines indicate pages included in this revision.

| | | | | | |
|-----------------|----------|-----------------|----------|---------------|----------|
| 90-9026-61,62 | (May-78) | 90-9026-109,110 | (May-79) | 90-9030-1,2 | (May-78) |
| 90-9026-63,64 | (May-79) | 90-9026-111,112 | (May-79) | 90-9030-3,4 | (May-78) |
| 90-9026-65,66 | (May-78) | 90-9026-113,114 | (May-79) | 90-9031-1,2 | (May-79) |
| 90-9026-67,68 | (May-78) | 90-9026-115,116 | (May-79) | 90-9031-3,4 | (May-78) |
| 90-9026-69,70 | (May-78) | 90-9026-117,118 | (May-79) | 90-9031-5,6 | (May-78) |
| 90-9026-71,72 | (May-78) | 90-9026-119,120 | (May-79) | 90-9031-7,8 | (May-79) |
| 90-9026-73,74 | (May-78) | 90-9026-121,122 | (May-79) | 90-9031-9,10 | (May-79) |
| 90-9026-75,76 | (May-79) | 90-9026-123,124 | (May-79) | 90-9031-11,12 | (May-79) |
| 90-9026-77,78 | (May-79) | 90-9026-125,126 | (May-79) | 90-9031-13,14 | (May-79) |
| 90-9026-79,80 | (May-79) | 90-9026-127,128 | (May-79) | 90-9031-15,16 | (May-78) |
| 90-9026-81,82 | (May-78) | 90-9026-129,130 | (May-79) | 90-9031-17,18 | (May-78) |
| 90-9026-83,84 | (May-79) | 90-9026-131,132 | (May-79) | 90-9031-19,20 | (May-79) |
| 90-9026-85,86 | (May-79) | 90-9026-133,134 | (May-79) | 90-9035-1,2 | (May-78) |
| 90-9026-87,88 | (May-78) | 90-9026-135,136 | (May-79) | 90-9035-3,4 | (May-78) |
| 90-9026-89,90 | (May-79) | 90-9026-137,138 | (May-79) | 90-9035-5,6 | (May-78) |
| 90-9026-91,92 | (May-78) | 90-9026-139,140 | (May-79) | 90-9035-7,8 | (May-78) |
| 90-9026-93,94 | (May-78) | 90-9026-141,142 | (May-79) | 90-9035-9,10 | (May-78) |
| 90-9026-95,96 | (May-79) | 90-9026-143,144 | (May-79) | 90-9035-11,12 | (May-78) |
| 90-9026-97,98 | (May-79) | 90-9026-145,146 | (May-79) | 90-9035-13,14 | (May-79) |
| 90-9026-99,100 | (May-78) | 90-9026-147,148 | (May-79) | 90-9035-15,16 | (May-78) |
| 90-9026-101,102 | (May-78) | 90-9026-149,150 | (May-79) | 90-9035-17,18 | (May-79) |
| 90-9026-103,104 | (May-79) | 90-9026-151,152 | (May-79) | 90-9035-19,20 | (May-79) |
| 90-9026-105,106 | (May-79) | 90-9026-153,154 | (May-79) | 90-9035-21,22 | (May-79) |
| 90-9026-107,108 | (May-79) | 90-9025-155,156 | (May-79) | 90-9035-23,24 | (May-79) |

Vertical lines indicate pages included in this revision.

Track systems—Continued

| | |
|---|-------------------|
| Sprocket | 0130-37 - 0130-38 |
| Installation | 0130-38 |
| Measuring sprocket wear | 0130-37 |
| Removal | 0130-37 |
| Repair | 0130-37 |
| Track adjuster cylinder | 0130-29 - 0130-31 |
| Components | 0130-29 - 0130-30 |
| Installation | 0130-30 - 0130-31 |
| Removal | 0130-29 |
| Repair | 0130-29 |
| Track chain assembly | 0130-13 - 0130-22 |
| Installation | 0130-21 - 0130-22 |
| Measuring chain wear | 0130-13 - 0130-14 |
| Removal | 0130-14 - 0130-15 |
| Repair | 0130-16 - 0130-20 |
| Assembly | 0130-18 - 0130-20 |
| Disassembly | 0130-16 - 0130-18 |
| Rotating pins and bushings | 0130-21 |
| Use of shims for assembly of used track components | 0130-21 |
| Track frame | 0130-33 - 0130-36 |
| Installation | 0130-36 |
| Removal | 0130-33 - 0130-34 |
| Repair | 0130-34 - 0130-36 |
| Recommended welding procedure | 0130-35 - 0130-36 |
| Track frame wear strips | 0130-35 |
| Track rollers | 0130-8 - 0130-11 |
| Checking roller wear | 0130-8 |
| Components | 0130-9 |
| Installation | 0130-11 |
| Removal | 0130-8 |
| Repair | 0130-8 - 0130-11 |
| Track shoes | 0130-12 |
| Installation | 0130-12 |
| Removal | 0130-12 |
| Repair | 0130-12 |
| Track testing | 9030-1 - 9030-3 |
| Adjustment | 9030-2 - 9030-3 |
| Front idler gears | 9030-3 |
| Inner guide adjustment | 9030-3 |
| Outer guide adjustment | 9030-3 |
| Track tension | 9030-2 |
| Diagnosing malfunctions | 9030-1 |
| Transfer drive: | |
| Gears, shafts, bearings | 0851-1 - 0851-7 |
| Installation | 0851-7 |
| Removal | 0851-1 |
| Repair | 0851-2 - 0851-7 |
| Housings and covers | 0841-3 - 0841-4 |
| Components | 0841-3 |
| Installation | 0841-4 |
| Removal | 0841-3 |
| Repair | 0841-4 |

| | |
|---|--------------------|
| Transmission control valve | 0360-68 - 0360-102 |
| Assembly | 0360-86 - 0360-101 |
| Automatic control valve | 0360-88 - 0360-90 |
| Automatic control valve shutoff valve | 0360-87 |
| Automatic control valve variable orifice | 0360-92 - 0360-94 |
| FNR valve | 0360-99 - 0360-100 |
| P1 over pressure relief valve | 0360-86 |
| P2 pressure regulator valve | 0360-86 |
| Port plate and cover assembly | 0360-101 |
| Speed control valve | 0360-97 - 0360-98 |
| Steering valve | 0360-95 - 0360-96 |
| Steering valve orifices | 0360-91 |
| Disassembly | 0360-70 - 0360-84 |
| Automatic control valve | 0360-73 - 0360-75 |
| Automatic control valve shutoff valve | 0360-73 |
| Automatic control valve variable orifice | 0360-76 - 0360-77 |
| FNR valve | 0360-82 - 0360-83 |
| P1 over pressure relief valve | 0360-72 |
| P2 pressure regulator valve | 0360-72 |
| Speed control valve | 0360-84 |
| Steering valve | 0360-79 - 0360-81 |
| Steering valve orifices | 0360-75 |
| Transmission control valve assembly | 0360-78 |
| Installation | 0360-102 |
| Removal | 0360-69 - 0360-70 |
| Repair | 0360-85 |
| Transmission controls | 0315-3 - 0315-14 |
| Automatic control valve shut- off valve control | 0315-13 - 0315-14 |
| Installation | 0315-13 - 0315-14 |
| Removal | 0315-13 |
| Repair | 0315-13 |
| Return to neutral linkage | 0315-14 |
| Installation | 0315-14 |
| Removal | 0315-14 |
| Repair | 0315-14 |
| Automatic control valve variable orifice linkage | 0315-10 - 0315-11 |
| Components | 0315-10 |
| Installation | 0315-11 |
| Removal | 0315-11 |
| Repair | 0315-11 |
| Forward and reverse speed control | 0315-6 - 0315-9 |
| Components | 0315-6 |
| Control head | 0315-7 - 0315-8 |
| Installation | 0315-8 |
| Removal | 0315-7 |
| Repair | 0315-7 |

Transmission controls—Continued

Forward and reverse speed control—Continued
Control linkage..... 0315-9
 Components..... 0315-9
 Installation..... 0315-9
 Removal..... 0315-9
 Repair..... 0315-9
Speed control support..... 0315-12
 Installation..... 0315-12
 Removal..... 0315-12
 Repair..... 0315-12
Steering linkage..... 0315-3 - 0315-5
 Installation..... 0315-5
 Removal..... 0315-3 - 0315-5
 Pedal steering upper linkage..... 0315-3 - 0315-5
 Repair..... 0315-5
Transmission filters..... 0360-109
 Components..... 0360-109
 Inspection..... 0360-109
 Installation..... 0360-109
 Removal..... 0360-109
Transmission motor..... 0360-40 - 0360-60
 Assembly..... 0360-53 - 0360-60
 Components..... 0360-40, 0360-52
 Disassembly..... 0360-41 - 0360-52
 Inspection..... 0360-53
 Installation..... 0360-60
 Removal..... 0360-40
Transmission oil filter indicator..... 1676-5
Transmission oil pressure gauge..... 1676-1
Transmission oil temperature gauge..... 1676-2
Transmission operating pressure valve..... 0360-106 - 0360-107
 Assembly..... 0360-107
 Components..... 0360-106
 Disassembly..... 0360-106
 Inspection..... 0360-106
 Installation..... 0360-107
 Removal..... 0360-106
Transmission pump..... 0360-6 - 0360-30
 Assembly..... 0360-21 - 0360-30
 Components..... 0360-6, 0360-19
 Disassembly..... 0360-8 - 0360-19
 Inspection..... 0360-20
 Installation..... 0360-30
 Removal..... 0360-6 - 0360-7
Turbocharger..... 0416-1 - 0416-8
 Assembly..... 0416-6 - 0416-7
 Components..... 0416-6
 Installation..... 0416-7 - 0416-8
 Removal..... 0416-1 - 0416-2

Turbocharger—Continued

Repair..... 0416-3 - 0416-6
Testing..... 0416-2
 Axial end play bearing test..... 0416-2
 Radial bearing movement..... 0416-2

V

Valve, brake..... 1160-1 - 1160-4
Valve, compressor relief..... 1830-26
Valve, double selector..... 4260-1
Valve, expansion..... 1830-24
Valve, loader control..... 3160-13 - 3160-17
Valve, manifold transmission..... 0360-64 - 0360-67
 Assembly..... 0360-67
 Disassembly..... 0360-64 - 0360-66
 Inspection..... 0360-66
 Installation..... 0360-67
 Removal..... 0360-64
Valve, motor displacement control..... 0360-61 - 0360-63
 Assembly..... 0360-62
 Components..... 0360-63
 Inspection..... 0360-62
 Installation..... 0360-62
 Removal..... 0360-61
 Repair..... 0360-61 - 0360-62
Valve, oil cooler bypass..... 0360-104 - 0360-105
 Assembly..... 0360-105
 Components..... 0360-104
 Disassembly..... 0360-105
 Inspection..... 0360-105
 Installation..... 0360-105
 Removal..... 0360-104
Valve, pump displacement control valve..... 0360-33 - 0360-37
 Assembly..... 0360-36 - 0360-37
 Components..... 0360-36
 Inspection..... 0360-36
 Installation..... 0360-37
 Removal..... 0360-33
 Repair..... 0360-33 - 0360-35
Valve, transmission bypass..... 0360-38 - 0360-39
 Assembly..... 0360-39
 Components..... 0360-38
 Disassembly..... 0360-38 - 0360-39
 Installation..... 0360-39
 Removal..... 0360-38
Valve, transmission control..... 0360-68 - 0360-102
 Assembly..... 0360-86 - 0360-101
 Automatic control valve..... 0360-88 - 0360-90
 Automatic control valve shutoff valve..... 0360-87

Valve, transmission control—Continued

Assembly—Continued

- Automatic control valve
 - variable orifice 0360-92 - 0360-94
- FNR valve 0360-99 - 0360-100
- P1 over pressure relief valve 0360-86
- P2 pressure regulator valve 0360-86
- Port plate and cover assembly 0360-101
- Speed control valve 0360-97 - 0360-98
- Steering valve 0360-95 - 0360-96
- Steering valve orifices 0360-91

Disassembly 0360-70 - 0360-84

- Automatic control valve 0360-73 - 0360-75
- Automatic control valve
 - shutoff valve 0360-73
- Automatic control valve
 - variable orifice 0360-76 - 0360-77
- FNR valve 0360-82 - 0360-83
- P1 over pressure relief valve 0360-72
- P2 pressure regulator valve 0360-72
- Speed control valve 0360-84
- Steering valve 0360-79 - 0360-81
- Steering valve orifices 0360-75

Transmission control valve assembly 0360-78

- Installation 0360-102
- Removal 0360-69 - 0360-70
- Repair 0360-85

Valve, transmission operating

- pressure 0360-106 - 0360-107
- Assembly 0360-107
- Components 0360-106
- Disassembly 0360-106
- Inspection 0360-106
- Installation 0360-107
- Removal 0360-106

Valves and cylinder head, engine . . 0409-1 - 0409-6

- Ventilating system, engine 0408-1
 - Components 0408-1
 - Installation 0408-1
 - Removal 0408-1
 - Repair 0408-1

Vibration damper 0415-1 - 0415-2

- Components 0415-1
- Installation 0415-2
- Removal 0415-1 - 0415-2
- Repair 0415-2

Voltmeter 1676-4

W

- Water manifold 0418-1 - 0418-2
- Water pump, engine 0417-1 - 0417-6
 - Components 0417-2
 - Installation 0417-6
 - Removal 0417-1
 - Repair 0417-1 - 0417-6
 - Assembly 0417-4 - 0417-6
 - Disassembly 0417-1 - 0417-3
 - Inspection 0417-4
- Windshield, ROPS without cab 1810-6
- Windshield washer 1810-9 - 1810-10
 - Installation 1810-10
 - Removal 1810-10
 - Repair 1810-10
- Windshield wiper, front 1810-8
 - Installation 1810-8
 - Removal 1810-8
 - Repair 1810-8
- Windshield wiper, rear 1810-9
 - Installation 1810-9
 - Removal 1810-9
 - Repair 1810-9
- Wiper switch 1674-3
- Wiring harness 1674-1
 - Removing body connectors from wires 1674-1



**COMPLETE PAGE LISTING
 WITH LATEST DATE LINES**

| | | | | | |
|--------------|----------|--------------|----------|----------------|----------|
| I-I-1,2 | (May-78) | 1-0130-29,30 | (May-78) | 3-0360-35,36 | (May-78) |
| I-I-3,4 | (May-78) | 1-0130-31,32 | (May-78) | 3-0360-37,38 | (May-78) |
| I-I-5,6 | (May-78) | 1-0130-33,34 | (May-78) | 3-0360-39,40 | (May-78) |
| I-I-7,8 | (May-78) | 1-0130-35,36 | (May-78) | 3-0360-41,42 | (May-78) |
| I-I-9,10 | (May-78) | 1-0130-37,38 | (May-78) | 3-0360-43,44 | (May-78) |
| I-I-11,12 | (May-78) | 1-0199-1,2 | (May-78) | 3-0360-45,46 | (May-78) |
| I-I-13,14 | (May-78) | 1-0199-3,4 | (May-78) | 3-0360-47,48 | (May-78) |
| I-I-15,16 | (May-78) | 1-0199-5,6 | (May-78) | 3-0360-49,50 | (May-78) |
| I-I-17,18 | (May-78) | 1-0199-7,8 | (May-78) | 3-0360-51,52 | (May-78) |
| I-I-19,20 | (May-78) | | | 3-0360-53,54 | (May-78) |
| I-I-21,22 | (May-78) | 2-0201-1,2 | (May-78) | 3-0360-55,56 | (May-78) |
| I-I-23,24 | (May-78) | 2-0201-3,4 | (May-78) | 3-0360-57,58 | (May-78) |
| I-I-25,26 | (May-78) | 2-0201-5,6 | (May-78) | 3-0360-59,60 | (May-78) |
| I-I-27,28 | (May-78) | 2-0250-1,2 | (May-78) | 3-0360-61,62 | (May-78) |
| I-I-29,30 | (May-78) | 2-0250-3,4 | (May-78) | 3-0360-63,64 | (May-78) |
| I-I-31,32 | (May-78) | 2-0250-5,6 | (May-78) | 3-0360-65,66 | (May-78) |
| I-II-1,2 | (May-78) | 2-0250-7,8 | (May-78) | 3-0360-67,68 | (May-78) |
| I-II-3,4 | (May-78) | 2-0250-9,10 | (May-78) | 3-0360-69,70 | (May-78) |
| I-II-5,6 | (May-78) | 2-0250-11,12 | (May-78) | 3-0360-71,72 | (May-78) |
| I-II-7,8 | (May-78) | 2-0250-13,14 | (May-78) | 3-0360-73,74 | (May-78) |
| I-III-1,2 | (May-78) | 2-0250-15,16 | (May-78) | 3-0360-75,76 | (May-78) |
| I-III-3,4 | (May-78) | 2-0250-17,18 | (May-78) | 3-0360-77,78 | (May-78) |
| I-IV-1,2 | (May-78) | 2-0299-1,2 | (May-78) | 3-0360-79,80 | (May-78) |
| I-IV-3,4 | (May-78) | 2-0299-3,4 | (May-78) | 3-0360-81,82 | (May-78) |
| I-IV-5,6 | (May-78) | 2-0299-5,6 | (May-78) | 3-0360-83,84 | (May-78) |
| I-IV-7,8 | (May-78) | | | 3-0360-85,86 | (May-78) |
| I-IV-9,10 | (May-78) | 3-0315-1,2 | (May-78) | 3-0360-87,88 | (May-78) |
| I-IV-11,12 | (May-78) | 3-0315-3,4 | (May-78) | 3-0360-89,90 | (May-78) |
| I-IV-13,14 | (May-78) | 3-0315-5,6 | (May-78) | 3-0360-91,92 | (May-78) |
| I-IV-15,16 | (May-78) | 3-0315-7,8 | (May-78) | 3-0360-93,94 | (May-78) |
| I-IV-17,18 | (May-78) | 3-0315-9,10 | (May-78) | 3-0360-95,96 | (May-78) |
| I-IV-19,20 | (May-78) | 3-0315-11,12 | (May-78) | 3-0360-97,98 | (May-78) |
| I-IV-21,22 | (May-78) | 3-0315-13,14 | (May-78) | 3-0360-99,100 | (May-78) |
| I-IV-23,24 | (May-78) | 3-0325-1,2 | (May-78) | 3-0360-101,102 | (May-78) |
| I-IV-25,26 | (May-78) | 3-0360-1,2 | (May-78) | 3-0360-103,104 | (May-78) |
| I-IV-27,28 | (May-78) | 3-0360-3,4 | (May-78) | 3-0360-105,106 | (May-78) |
| I-V-1,2 | (May-78) | 3-0360-5,6 | (May-78) | 3-0360-107,108 | (May-78) |
| | | 3-0360-7,8 | (May-78) | 3-0360-109,110 | (May-78) |
| 1-0130-1,2 | (May-78) | 3-0360-9,10 | (May-78) | 3-0370-1,2 | (May-78) |
| 1-0130-3,4 | (May-78) | 3-0360-11,12 | (May-78) | 3-0370-3,4 | (May-78) |
| 1-0130-5,6 | (May-78) | 3-0360-13,14 | (May-78) | 3-0370-5,6 | (May-78) |
| 1-0130-7,8 | (May-78) | 3-0360-15,16 | (May-78) | 3-0399-1,2 | (May-78) |
| 1-0130-9,10 | (May-78) | 3-0360-17,18 | (May-78) | 3-0399-3,4 | (May-78) |
| 1-0130-11,12 | (May-78) | 3-0360-19,20 | (May-78) | 3-0399-5,6 | (May-78) |
| 1-0130-13,14 | (May-78) | 3-0360-21,22 | (May-78) | 3-0399-7,8 | (May-78) |
| 1-0130-15,16 | (May-78) | 3-0360-23,24 | (May-78) | 3-0399-9,10 | (May-78) |
| 1-0130-17,18 | (May-78) | 3-0360-25,26 | (May-78) | 3-0399-11,12 | (May-78) |
| 1-0130-19,20 | (May-78) | 3-0360-27,28 | (May-78) | 3-0399-13,14 | (May-78) |
| 1-0130-21,22 | (May-78) | 3-0360-29,30 | (May-78) | 3-0399-15,16 | (May-78) |
| 1-0130-23,24 | (May-78) | 3-0360-31,32 | (May-78) | 3-0399-17,18 | (May-78) |
| 1-0130-25,26 | (May-78) | 3-0360-33,34 | (May-78) | 3-0399-19,20 | (May-78) |
| 1-0130-27,28 | (May-78) | | | 3-0399-21,22 | (May-78) |

| | | | | | |
|--------------|----------|--------------|----------|---------------|----------|
| 4-0400-1,2 | (May-78) | 4-0499-11,12 | (May-78) | 16-1672-3,4 | (May-78) |
| 4-0400-3,4 | (May-78) | 4-0499-13,14 | (May-78) | 16-1672-5,6 | (May-78) |
| 4-0400-5,6 | (May-78) | 4-0499-15,16 | (May-78) | 16-1672-7,8 | (May-78) |
| 4-0400-7,8 | (May-78) | 4-0499-17,18 | (May-78) | 16-1672-9,10 | (May-78) |
| 4-0401-1,2 | (May-78) | 4-0499-19,20 | (May-78) | 16-1672-11,12 | (May-78) |
| 4-0401-3,4 | (May-78) | 4-0499-21,22 | (May-78) | 16-1672-13,14 | (May-78) |
| 4-0401-5,6 | (May-78) | 4-0499-23,24 | (May-78) | 16-1672-15,16 | (May-78) |
| 4-0401-7,8 | (May-78) | 4-0499-25,26 | (May-78) | 16-1672-17,18 | (May-78) |
| 4-0402-1,2 | (May-78) | 4-0499-27,28 | (May-78) | 16-1672-19,20 | (May-78) |
| 4-0402-3,4 | (May-78) | 4-0499-29,30 | (May-78) | 16-1672-21,22 | (May-78) |
| 4-0403-1,2 | (May-78) | 4-0499-31,32 | (May-78) | 16-1672-23,24 | (May-78) |
| 4-0403-3,4 | (May-78) | 4-0499-33,34 | (May-78) | 16-1672-25,26 | (May-78) |
| 4-0403-5,6 | (May-78) | 4-0499-35,36 | (May-78) | 16-1673-1,2 | (May-78) |
| 4-0404-1,2 | (May-78) | 4-0499-37,38 | (May-78) | 16-1674-1,2 | (May-78) |
| 4-0404-3,4 | (May-78) | 4-0499-39,40 | (May-78) | 16-1674-3,4 | (May-78) |
| 4-0404-5,6 | (May-78) | 4-0499-41,42 | (May-78) | 16-1674-5,6 | (May-78) |
| 4-0407-1,2 | (May-78) | 4-0499-43,44 | (May-78) | 16-1675-1,2 | (May-78) |
| 4-0407-3,4 | (May-78) | | | 16-1676-1,2 | (May-78) |
| 4-0407-5,6 | (May-78) | 5-0505-1,2 | (May-78) | 16-1676-3,4 | (May-78) |
| 4-0408-1,2 | (May-78) | 5-0505-3,4 | (May-78) | 16-1676-5,6 | (May-78) |
| 4-0409-1,2 | (May-78) | 5-0505-5,6 | (May-78) | 16-1699-1,2 | (May-78) |
| 4-0409-3,4 | (May-78) | 5-0510-1,2 | (May-78) | 16-1699-3,4 | (May-78) |
| 4-0409-5,6 | (May-78) | 5-0510-3,4 | (May-78) | 16-1699-5,6 | (May-78) |
| 4-0410-1,2 | (May-78) | 5-0515-1,2 | (May-78) | 16-1699-7,8 | (May-78) |
| 4-0413-1,2 | (May-78) | 5-0515-3,4 | (May-78) | 16-1699-9,10 | (May-78) |
| 4-0413-3,4 | (May-78) | 5-0515-5,6 | (May-78) | | |
| 4-0413-5,6 | (May-78) | 5-0520-1,2 | (May-78) | 17-1740-1,2 | (May-78) |
| 4-0413-7,8 | (May-78) | 5-0530-1,2 | (May-78) | 17-1740-3,4 | (May-78) |
| 4-0413-9,10 | (May-78) | 5-0540-1,2 | (May-78) | 17-1746-1,2 | (May-78) |
| 4-0413-11,12 | (May-78) | 5-0560-1,2 | (May-78) | 1701749-1,2 | (May-78) |
| 4-0414-1,2 | (May-78) | 5-0599-1,2 | (May-78) | | |
| 4-0415-1,2 | (May-78) | | | 18-1810-1,2 | (May-78) |
| 4-0416-1,2 | (May-78) | 8-0841-1,2 | (May-78) | 18-1810-3,4 | (May-78) |
| 4-0416-3,4 | (May-78) | 8-0841-3,4 | (May-78) | 18-1810-5,6 | (May-78) |
| 4-0416-5,6 | (May-78) | 8-0851-1,2 | (May-78) | 18-1810-7,8 | (May-78) |
| 4-0416-7,8 | (May-78) | 8-0851-3,4 | (May-78) | 18-1810-9,10 | (May-78) |
| 4-0417-1,2 | (May-78) | 8-0851-5,6 | (May-78) | 18-1821-1,2 | (May-78) |
| 4-0417-3,4 | (May-78) | 8-0851-7,8 | (May-78) | 18-1821-3,4 | (May-78) |
| 4-0417-5,6 | (May-78) | 8-0899-1,2 | (May-78) | 18-1821-5,6 | (May-78) |
| 4-0418-1,2 | (May-78) | | | 18-1830-1,2 | (May-78) |
| 4-0419-1,2 | (May-78) | 11-1111-1,2 | (May-78) | 18-1830-3,4 | (May-78) |
| 4-0420-1,2 | (May-78) | 11-1111-3,4 | (May-78) | 18-1830-5,6 | (May-78) |
| 4-0421-1,2 | (May-78) | 11-1111-5,6 | (May-78) | 18-1830-7,8 | (May-78) |
| 4-0421-3,4 | (May-78) | 11-1115-1,2 | (May-78) | 18-1830-9,10 | (May-78) |
| 4-0422-1,2 | (May-78) | 11-1160-1,2 | (May-78) | 18-1830-11,12 | (May-78) |
| 4-0422-3,4 | (May-78) | 11-1160-3,4 | (May-78) | 18-1830-13,14 | (May-78) |
| 4-0422-5,6 | (May-78) | 11-1199-1,2 | (May-78) | 18-1830-15,16 | (May-78) |
| 4-0422-7,8 | (May-78) | | | 18-1830-17,18 | (May-78) |
| 4-0422-9,10 | (May-78) | 15-1511-1,2 | (May-78) | 18-1830-19,20 | (May-78) |
| 4-0423-1,2 | (May-78) | 15-1511-3,4 | (May-78) | 18-1830-21,22 | (May-78) |
| 4-0429-1,2 | (May-78) | 15-1512-1,2 | (May-78) | 18-1830-23,24 | (May-78) |
| 4-0433-1,2 | (May-78) | | | 18-1830-25,26 | (May-78) |
| 4-0499-1,2 | (May-78) | 16-1671-1,2 | (May-78) | 18-1830-27,28 | (May-78) |
| 4-0499-3,4 | (May-78) | 16-1671-3,4 | (May-78) | 18-1830-29,30 | (May-78) |
| 4-0499-5,6 | (May-78) | 16-1671-5,6 | (May-78) | 18-1899-1,2 | (May-78) |
| 4-0499-7,8 | (May-78) | 16-1671-7,8 | (May-78) | 18-1899-3,4 | (May-78) |
| 4-0499-9,10 | (May-78) | 16-1672-1,2 | (May-78) | | |

| | | | | | |
|---------------|----------|----------------|----------|-----------------|----------|
| 19-1910-1,2 | (May-78) | 90-9015-11,12 | (May-78) | 90-9026-39,40 | (May-78) |
| 19-1910-3,4 | (May-78) | 90-9015-13,14 | (May-78) | 90-9026-41,42 | (May-78) |
| 19-1910-5,6 | (May-78) | 90-9015-15,16 | (May-78) | 90-9026-43,44 | (May-78) |
| 19-1913-1,2 | (May-78) | 90-9015-17,18 | (May-78) | 90-9026-45,46 | (May-78) |
| 19-1921-1,2 | (May-78) | 90-9015-19,20 | (May-78) | 90-9026-47,48 | (May-78) |
| 19-1927-1,2 | (May-78) | 90-9015-21,22 | (May-78) | 90-9026-49,50 | (May-78) |
| | | 90-9015-23,24 | (May-78) | 90-9026-51,52 | (May-78) |
| 20-2003-1,2 | (May-78) | 90-9015-25,26 | (May-78) | 90-9026-53,54 | (May-78) |
| 20-2003-3,4 | (May-78) | 90-9015-27,28 | (May-78) | 90-9026-55,56 | (May-78) |
| 20-2004-1,2 | (May-78) | 90-9015-29,30 | (May-78) | 90-9026-57,58 | (May-78) |
| 20-2006-1,2 | (May-78) | 90-9015-31,32 | (May-78) | 90-9026-59,60 | (May-78) |
| | | 90-9020-1,2 | (May-78) | 90-9026-61,62 | (May-78) |
| 31-3102-1,2 | (May-78) | 90-9020-3,4 | (May-78) | 90-9026-63,64 | (May-78) |
| 31-3102-3,4 | (May-78) | 90-9020-5,6 | (May-78) | 90-9026-65,66 | (May-78) |
| 31-3115-1,2 | (May-78) | 90-9020-7,8 | (May-78) | 90-9026-67,68 | (May-78) |
| 31-3140-1,2 | (May-78) | 90-9020-9,10 | (May-78) | 90-9026-69,70 | (May-78) |
| 31-3160-1,2 | (May-78) | 90-9020-11,12 | (May-78) | 90-9026-71,72 | (May-78) |
| 31-3160-3,4 | (May-78) | 90-9025-1,2 | (May-78) | 90-9026-73,74 | (May-78) |
| 31-3160-5,6 | (May-78) | 90-9025-3,4 | (May-78) | 90-9026-75,76 | (May-78) |
| 31-3160-7,8 | (May-78) | 90-9025-5,6 | (May-78) | 90-9026-77,78 | (May-78) |
| 31-3160-9,10 | (May-78) | 90-9025-7,8 | (May-78) | 90-9026-79,80 | (May-78) |
| 31-3160-11,12 | (May-78) | 90-9025-9,10 | (May-78) | 90-9026-81,82 | (May-78) |
| 31-3160-13,14 | (May-78) | 90-9025-11,12 | (May-78) | 90-9026-83,84 | (May-78) |
| 31-3160-15,16 | (May-78) | 90-9025-13,14 | (May-78) | 90-9026-85,86 | (May-78) |
| 31-3160-17,18 | (May-78) | 90-9025-15,16 | (May-78) | 90-9026-87,88 | (May-78) |
| 31-3160-19,20 | (May-78) | 90-9025-17,18 | (May-78) | 90-9026-89,90 | (May-78) |
| 31-3160-21,22 | (May-78) | 90-9025-19,20 | (May-78) | 90-9026-91,92 | (May-78) |
| 31-3160-23,24 | (May-78) | 90-9025-21,22 | (May-78) | 90-9026-93,94 | (May-78) |
| 31-3160-25,26 | (May-78) | 90-9025-23,24 | (May-78) | 90-9026-95,96 | (May-78) |
| 31-3160-27,28 | (May-78) | 90-9025-25,26 | (May-78) | 90-9026-97,98 | (May-78) |
| 31-3160-29,30 | (May-78) | 90-9025-27,28 | (May-78) | 90-9026-99,100 | (May-78) |
| 31-3160-31,32 | (May-78) | 90-9025A-1,2 | (May-78) | 90-9026-101,102 | (May-78) |
| 31-3199-1,2 | (May-78) | 90-9025A-3,4 | (May-78) | 90-9026-103,104 | (May-78) |
| 31-3199-3,4 | (May-78) | 90-9025A-5,6 | (May-78) | 90-9026-105,106 | (May-78) |
| 31-3199-5,6 | (May-78) | 90-9025A-7,8 | (May-78) | 90-9026-107,108 | (May-78) |
| | | 90-9025A-9,10 | (May-78) | 90-9026-109,110 | (May-78) |
| 40-4041-1,2 | (May-78) | 90-9025A-11,12 | (May-78) | 90-9026-111,112 | (May-78) |
| 40-4041-3,4 | (May-78) | 90-9026-1,2 | (May-78) | 90-9026-113,114 | (May-78) |
| | | 90-9026-3,4 | (May-78) | 90-9026-115,116 | (May-78) |
| 42-4215-1,2 | (May-78) | 90-9026-5,6 | (May-78) | 90-9026-117,118 | (May-78) |
| 42-4215-3,4 | (May-78) | 90-9026-7,8 | (May-78) | 90-9026-119,120 | (May-78) |
| 42-4260-1,2 | (May-78) | 90-9026-9,10 | (May-78) | 90-9026-121,122 | (May-78) |
| | | 90-9026-11,12 | (May-78) | 90-9026-123,124 | (May-78) |
| 90-9005-1,2 | (May-78) | 90-9026-13,14 | (May-78) | 90-9026-125,126 | (May-78) |
| 90-9005-3,4 | (May-78) | 90-9026-15,16 | (May-78) | 90-9026-127,128 | (May-78) |
| 90-9010-1,2 | (May-78) | 90-9026-17,18 | (May-78) | 90-9026-129,130 | (May-78) |
| 90-9010-3,4 | (May-78) | 90-9026-19,20 | (May-78) | 90-9026-131,132 | (May-78) |
| 90-9010-5,6 | (May-78) | 90-9026-21,22 | (May-78) | 90-9026-133,134 | (May-78) |
| 90-9010-7,8 | (May-78) | 90-9026-23,24 | (May-78) | 90-9026-135,136 | (May-78) |
| 90-9010-9,10 | (May-78) | 90-9026-25,26 | (May-78) | 90-9026-137,138 | (May-78) |
| 90-9010-11,12 | (May-78) | 90-9026-27,28 | (May-78) | 90-9026-139,140 | (May-78) |
| 90-9010-13,14 | (May-78) | 90-9026-29,30 | (May-78) | 90-9026-141,142 | (May-78) |
| 90-9015-1,2 | (May-78) | 90-9026-31,32 | (May-78) | 90-9026-143,144 | (May-78) |
| 90-9015-3,4 | (May-78) | 90-9026-33,34 | (May-78) | 90-9026-145,146 | (May-78) |
| 90-9015-5,6 | (May-78) | 90-9026-35,36 | (May-78) | 90-9026-147,148 | (May-78) |
| 90-9015-7,8 | (May-78) | 90-9026-37,38 | (May-78) | 90-9026-149,150 | (May-78) |
| 90-9015-9,10 | (May-78) | | | | |

| | | | | | |
|-----------------|----------|---------------|----------|---------------|----------|
| 90-9026-151,152 | (May-78) | 90-9031-11,12 | (May-78) | 90-9035-7,8 | (May-78) |
| 90-9026-153,154 | (May-78) | 90-9031-13,14 | (May-78) | 90-9035-9,10 | (May-78) |
| 90-9030-1,2 | (May-78) | 90-9031-15,16 | (May-78) | 90-9035-11,12 | (May-78) |
| 90-9030-3,4 | (May-78) | 90-9031-17,18 | (May-78) | 90-9035-13,14 | (May-78) |
| 90-9031-1,2 | (May-78) | 90-9031-19,20 | (May-78) | 90-9035-15,16 | (May-78) |
| 90-9031-3,4 | (May-78) | 90-9035-1,2 | (May-78) | 90-9035-17,18 | (May-78) |
| 90-9031-5,6 | (May-78) | 90-9035-3,4 | (May-78) | 90-9035-19,20 | (May-78) |
| 90-9031-7,8 | (May-78) | 90-9035-5,6 | (May-78) | 90-9035-21,22 | (May-78) |
| 90-9031-9,10 | (May-78) | | | 90-9035-23,24 | (May-78) |

Group II INTRODUCTION AND SAFETY INFORMATION INTRODUCTION

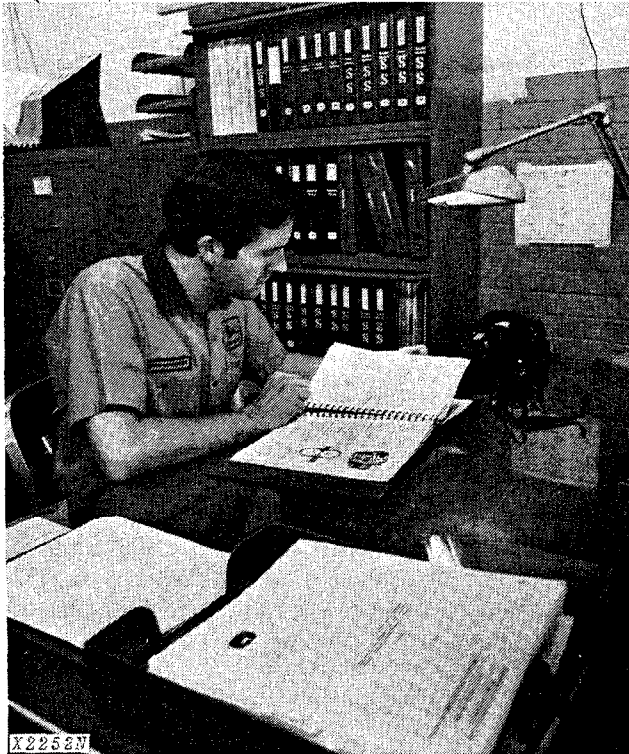

Use FOS Manuals for Reference

X2252N

This technical manual is part of a twin concept of service:

The two kinds of manuals work as a team to give you both the general background and technical details of shop service.

•FOS Manuals—for reference

Fundamentals of Service (FOS) Manuals cover basic theory of operation, *fundamentals* of trouble shooting, *general* maintenance, and *basic* types of failures and their causes. FOS Manuals are for training new personnel and for reference by experienced service technicians.



When a service technician should refer to a FOS Manual for more information, a FOS symbol like the one at the left is used in the TM to identify the reference.

•Technical Manuals—for actual service

Technical Manuals are *concise* service guides for a *specific* machine. Technical manuals are on-the-job guides containing only the vital information needed by an experienced service technician.



Use Technical Manuals for Actual Service

X2253N

This technical manual was planned and written for you—an experienced service technician. Keep it in a permanent binder in the shop where it is handy. Refer to it whenever in doubt about correct service procedures or specifications.

Some features of this manual:

- Inside front cover - "Table of Contents".
- Section 1 - Contents, safety information, general specifications, general services and fuels and lubricants.
- Sections 1 through 42 - Removal, repair, testing (components removed), installation, and adjustment.
- Section 90 - Detailed explanation of system operation, diagnosis, visual inspection, testing, and adjustments.
- Specifications grouped and illustrated at the end of each section.

MAINTENANCE WITHOUT ACCIDENT WORK SAFELY



T27999N

 This safety alert symbol is used for important safety messages. When you see this symbol, the possibility of personal injury exists if safety message is not followed.

**EVERY EMPLOYER HAS A
SAFETY PROGRAM. KNOW
WHAT IT IS!**

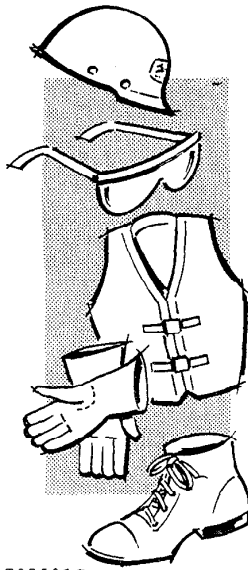

T27501

Consult your shop supervisor for specific instructions on a job, and the safety equipment required.

For instance, you may need: Hard hat, safety shoes, safety goggles, heavy gloves, reflector vests, ear protectors, respirators.

Litho in U.S.A.

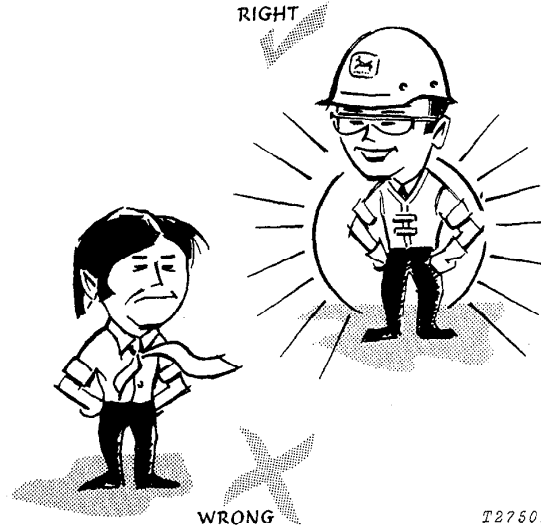

WRONG

T27502

ALWAYS AVOID loose clothing or any accessory—flopping cuffs, dangling neckties and scarves, or rings and wrist watches—that can catch in moving parts and put you out of work.

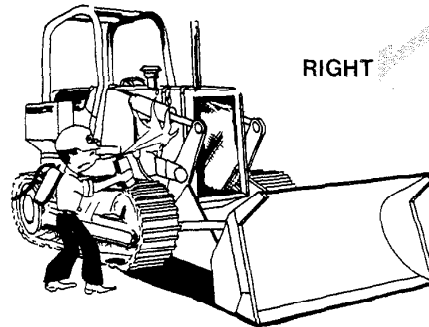

RIGHT

T43865N

BE ALERT!

Plan ahead — work safely — avoid accidental damage and injury. If a careless moment does cause an accident or fire, react quickly with the tools and skills at hand — know how to use a first aid kit and a fire extinguisher — and where to get aid and assistance. In an emergency, split-second action is the key to safety.

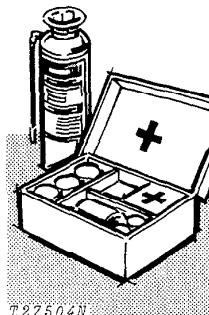

T27504N

MAINTENANCE WITHOUT ACCIDENT

Specific safety procedures should always be observed, whether servicing or making repairs on the crawler. Remembering these—in time!—can prevent an injury...or save your life...

AVOID FIRE HAZARDS—

Fuel Is Dangerous!

Don't smoke while refueling.

Don't smoke while handling highly flammable material.

Engine should be shut off when refueling.

Use care in refueling if the engine is hot.

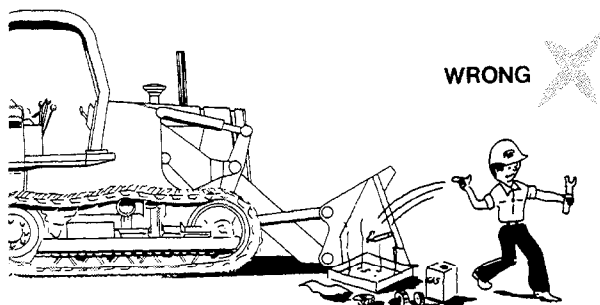

T43866N

Don't use open pans of gasoline or diesel fuel for cleaning parts. Good commercial, nonflammable solvents are preferred.

Battery Gas Is Highly Flammable!

Provide adequate ventilation when charging batteries.



T27508N

Don't check battery charge by placing metal objects across the posts.

Don't allow sparks or open flame near batteries.

Don't smoke near battery.

Flame Is Not a Flashlight!

Never check fuel, battery electrolyte or coolant levels with an open flame.

Never use an open flame to look for leaks anywhere on the equipment.

Never use an open flame as a light anywhere on or around the equipment.

KNOW WHERE FIRE EXTINGUISHERS ARE KEPT!

UNDER ALL MAINTENANCE CONDITIONS—

Do not perform any work on the crawler unless authorized to do so. Then be sure you understand the services required. Follow recommended procedures.

Never service the equipment while it is being operated.

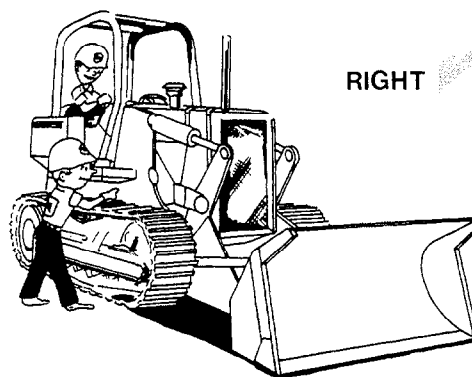

T43867N

Avoid working on equipment with the engine running. If it is necessary to make checks with the engine running, **ALWAYS USE TWO SERVICE TECHNICIANS**—one, the operator, at the controls, the other checking in view of the operator. Also, put the forward-reverse speed control lever in neutral, set the park brake, and apply any safety locks provided. **KEEP HANDS AWAY FROM MOVING PARTS.**

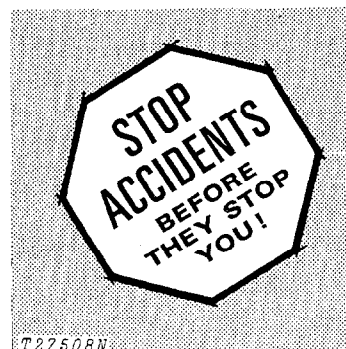

T27508N

MAINTENANCE WITHOUT ACCIDENT

Before servicing, adjusting, or repairing crawlers which have attachments such as buckets, etc—**LOWER** attachments to the ground—or, if necessary to raise them for access to certain parts, **SECURELY SUPPORT** with lift arm locking pin. **DO NOT** rely on controls to support or position attachments for maintenance.

Never allow **ANYONE** to walk under equipment that is raised and not properly blocked.

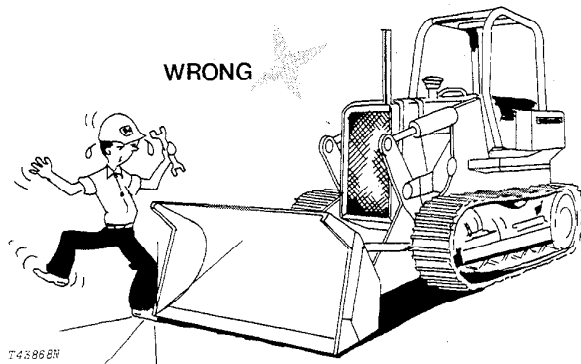

Avoid working directly under raised and blocked equipment unless absolutely necessary.

If the crawler is on an incline, block it securely.

Use hoisting equipment for lifting heavy parts. **TAKE CARE! WATCH OUT FOR OTHER PEOPLE IN THE VICINITY.**

Use extreme caution in removing radiator caps, drain plugs, grease fittings, or hydraulic pressure caps.

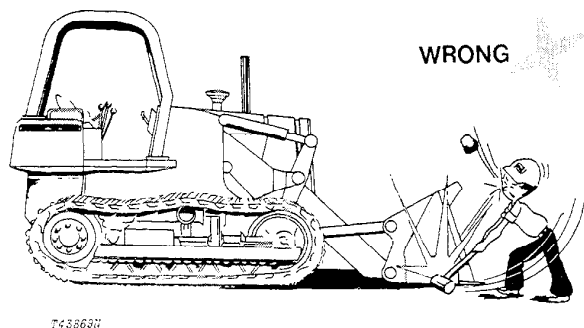

Wear safety glasses when drilling, grinding, or hammering metal.

Make sure the maintenance area is adequately vented.

Keep maintenance area **CLEAN AND DRY**. Oily and wet floors are slippery; greasy rags are a fire hazard; wet spots are dangerous when working with electrical equipment.

Store starting aids in a cool and well-ventilated place, out of the reach of unauthorized personnel.

SERVICING PRECAUTIONS

Stop the engine before cleaning or lubricating the crawler.

Lower bucket and ripper to the ground *carefully*.

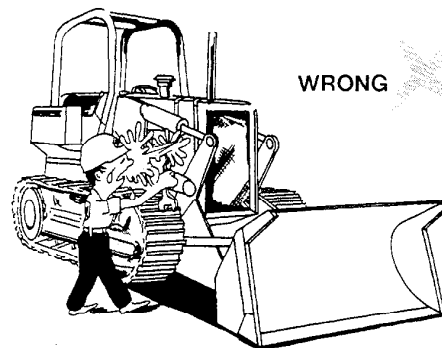

Engine coolant gets hot! Don't remove the radiator cap until coolant temperature is below the boiling point. Then turn cap slightly to relieve pressure before removing.

Exhaust gases are dangerous! Periodically check exhaust system for excessive leakage.

Don't forget a hydraulic system may be pressurized! To relieve system pressure, stop engine, lower bucket and ripper and operate bucket and ripper control levers until system fails to respond.

When checking hydraulic pressure, be sure to use the correct test gauge for the pressure in the particular system.

MAINTENANCE WITHOUT ACCIDENT

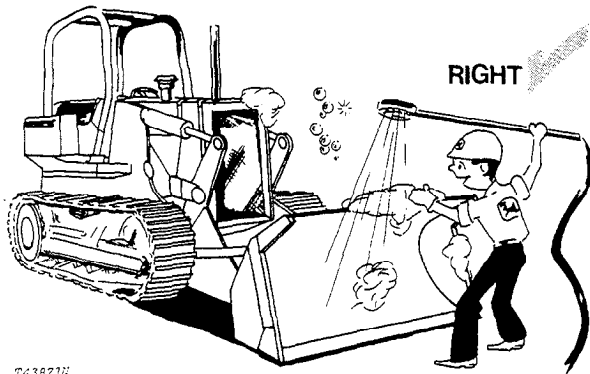

T43871N

Keep ALL components free of dirt and oil. This attention will minimize fire hazards and facilitate spotting of loose or defective parts.

When preparing engine for storage, remember that inhibitor is volatile and therefore dangerous. Seal and tape openings after adding the inhibitor. Keep container tightly closed when not in use.

ADJUSTING PRECAUTIONS

... for Operating Adjustments

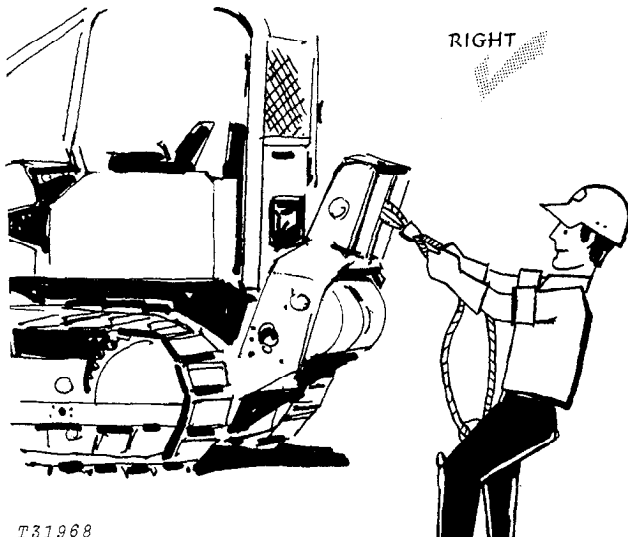

T31968

Always wear gloves when handling cable.

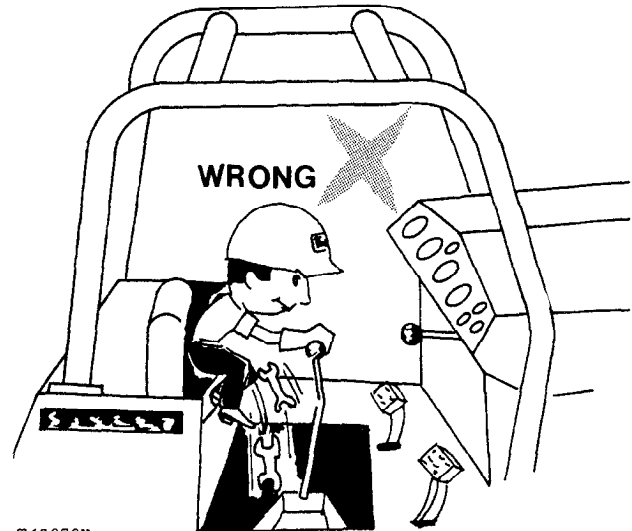

T43872N

Before removing any housing covers, stop engine. Take all objects from your pockets which could fall into the opened housings. Don't let adjusting wrenches fall into opened housings.

... for Maintenance Adjustments

Don't attempt to check belt tension while the engine is running.

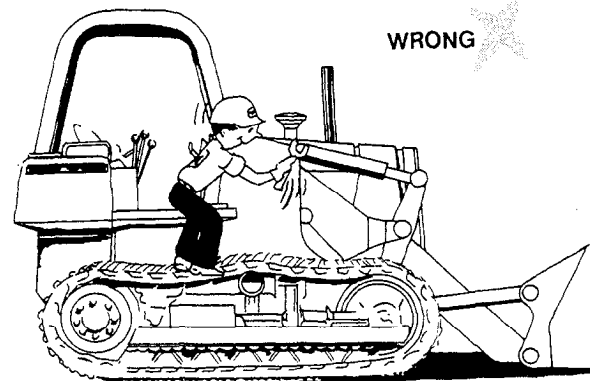

T43873N

Don't adjust the fuel system while the machine is in motion.

MAINTENANCE WITHOUT ACCIDENT

PRECAUTIONS DURING REPAIR

Before working on the engine fuel system—close fuel shutoff valve.

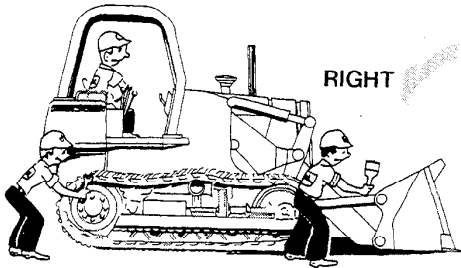

2438741

Before repairing the electrical system, or performing a major overhaul, make sure the batteries are disconnected.

When changing cutting edges on bucket, stop the engine and securely block the bucket.

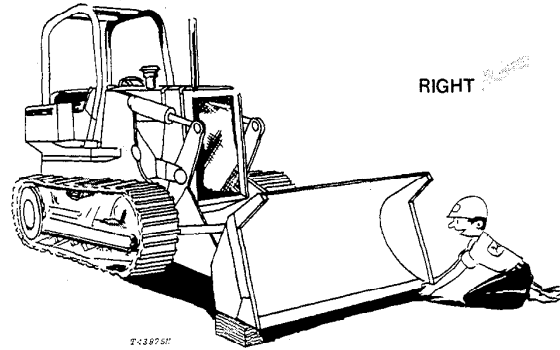

2438751

Never let your bare hands come in contact with sharp edges. WEAR GLOVES.

MAINTENANCE WITHOUT ACCIDENT

KNOW EQUIPMENT IS READY!

Check guards, ROPS, safety bars—all protective devices installed on the crawler. Every one should be in place and secure.

CHECK IT OUT!

- GUARDS
- SHIELDS
- PROTECTIVE DEVICES
- ROLL-OVER PROTECTIVE STRUCTURES
- SEAT BELTS
- FIRE EXTINGUISHER, ETC.

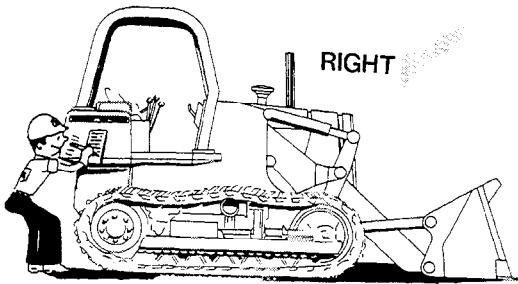

T4387611

Carefully inspect equipment for visual defects—leaks in fuel, lubrication, and hydraulic systems. Do not search for pressurized fluid leaks with your hands. Use cardboard or wood to search for leaks.

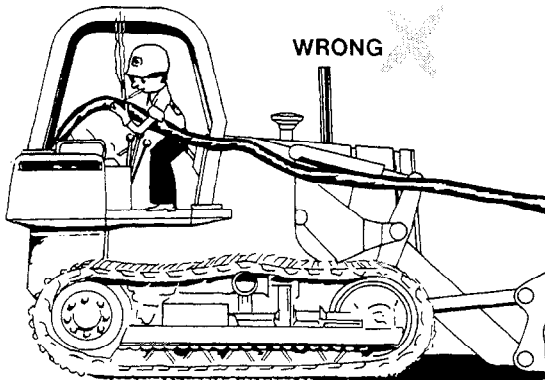

T4387711

Check levels of fuel, coolant, hydraulic fluid, and lubricating oil. If fuel must be added—**FIRST, PUT OUT THAT CIGARET.**

Check and secure all caps and filler plugs for fuel, oils, radiator, etc.

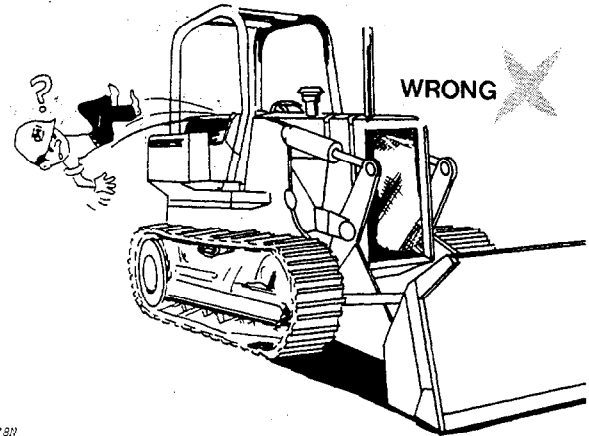

T4387811

Be sure to clean any oil, grease or mud accumulation from floor of operator's compartment, stepping points, and grab rails to minimize the danger of slipping.

In freezing weather beware of snow or ice deposits on stepping points, grab rails, and floor.

Remove loose bolts, tools, or other objects from floor of operator's compartment.

Although it is impractical to try to cover every possible maintenance situation, the safety precautions recommended here should serve to develop and promote safe maintenance procedures.

The information contained in this manual is not intended to replace safety codes, insurance requirements, federal, state, and local laws, rules and regulations. In particular, your service area or jobsite activities may be subject to state safety rules and/or federal regulation under the Occupational Safety and Health Act (OSHA). Familiarize yourself with all regulations applicable to your situation in order to avoid possible safety violations.

Illustrations and copy reproduced in part by permission of Construction Industry Manufacturers' Association (CIMA).

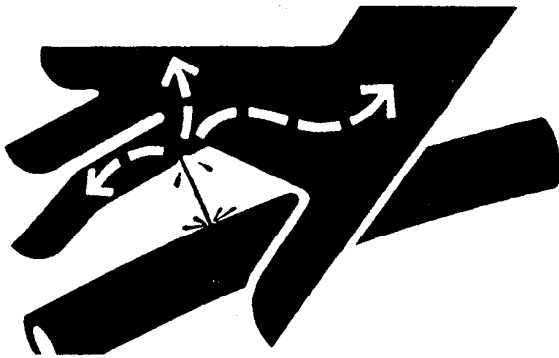

X9811

Escaping fluid under pressure can penetrate the skin causing serious injury. Relieve pressure before disconnecting hydraulic or other lines. Tighten all connections before applying pressure. Keep hands and body away from pinholes and nozzles which eject fluids under high pressure. Use a piece of cardboard or paper to search for leaks. Do not use your hand.

If ANY fluid is injected into the skin, it must be surgically removed within a few hours by a doctor familiar with this type injury or gangrene may result.

High pressure may be present in track cylinder. If grease does not immediately escape from vent hole, drive crawler loader forward and backward slowly, then tighten check valve.

Use extreme care when servicing area of track adjuster and recoil spring. Do not attempt to disassemble without proper tools and knowledge of disassembly procedure.

If ROLL-GARD® protective frame or ROLL-OVER protective equipment is loosened or removed for any reason, make certain all parts are reinstalled correctly. Tighten mounting bolts to proper torque. The protection offered by ROPS will be impaired if the ROPS is subject to structural damage, has been involved in an overturn incident or is in anyway altered. Damaged ROPS should be replaced, not reused.

Avoid possible injury or death from machinery runaway.

Do not start engine by shorting across starter terminals. Machine will start in gear and will move if normal circuitry is bypassed.

NEVER start engine while standing on ground. Start engine only from operator's seat, with transmission in neutral, neutral lock engaged, and park brake applied.

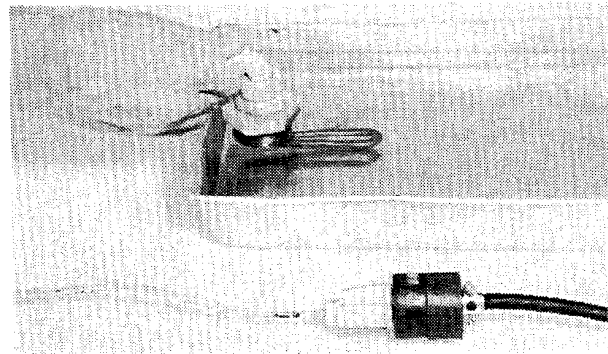

T67098

Use a heavy-duty grounded cord to connect coolant heater to electrical power.

Do not plug into electrical power unless heating element is immersed in coolant. Sheath could burst and result in personal injury.

Prolonged exposure to loud noise can cause impairment or loss of hearing. Wear a suitable hearing protective device such as earmuffs or earplugs to protect against objectionable or uncomfortable loud noise.

Starting fluid is highly flammable. Do not puncture or incinerate starting fluid containers.

| Hydraulic Cylinders: | Bore | Stroke |
|---|------------------------|-------------------|
| Boom, (2) . . . | 6.25 in. (159 mm) | 38 in. (965 mm) |
| Bucket (2) . . . | 5.50 in. (140 mm) | 26.1 in. (663 mm) |
| Cylinder rods . . . Ground, heat-treated, chrome-plated, polished | | |
| Boom cylinder rods | 4.00 in. (102 mm) dia. | |
| Bucket cylinder rods | 3.75 in. (95 mm) dia. | |

Tracks: 7-roller track frame with front and rear track guides and sprocket guard. DURA-TRAX™ deep-heat treated sealed track links and through-hardened sealed rollers provide maximum wear resistance.

| | |
|-------------------------------------|--|
| Two bar grouser | 18 in. (457 mm) |
| Track shoes, each side | 39 |
| Ground contact area | 3996 sq. in. (25 780 cm ²) |
| Ground pressure | 12.4 psi (0.85 bar) (0.87 kg/cm ²) |
| Length of track on ground | 111 in. (2.82 m) |
| Track gauge | 76 in. (1.93 m) |
| Carrier rollers | 2 each side |
| Adjustment | Hydraulic |
| Minimum ground clearance | 16.6 in. (422 mm) |

| Capacities: | U.S. | Liters |
|------------------------------|-------------|---------------|
| Cooling system | 10.5 gal. | 39.8 |
| Fuel tank | 106 gal. | 401.2 |
| Crankcase, including | | |
| filters | 36.5 qt. | 34.5 |
| Splitter drive | 1.5 gal. | 5.7 |
| Final drive, each: | | |
| 1st reduction | 5.25 gal. | 20.0 |
| 2nd reduction | 3.5 gal. | 13.2 |
| Loader hydraulic | | |
| system | 40 gal. | 151.4 |
| Hydrostatic drives | 46 gal. | 174.1 |

SAE Operating Weight 49,600 lb. (22 499 kg)

CRAWLER LOADER DIMENSIONS

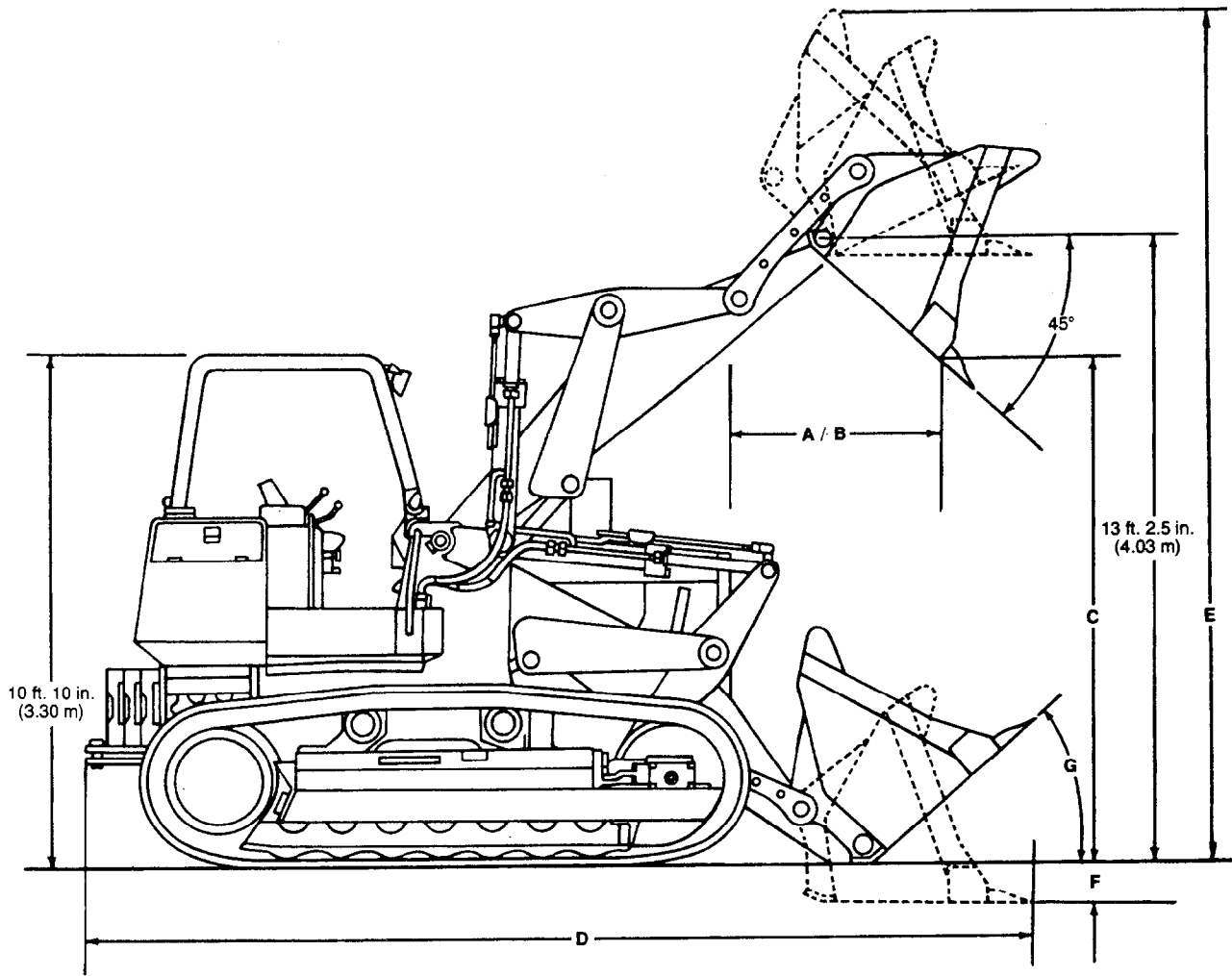

| BUCKET CAPACITIES | DIMENSIONS | | | | | | Rollback Angle | |
|-----------------------------------|--------------------------------------|---|---------------------------------------|------------------|------------------|------------------|----------------|----------------|
| | A | B | C | D | E | F | G | |
| | Reach at Max. Height (45° Discharge) | Reach at 7 ft. (2.13 m) Clearance (45° Discharge) | Clearance Max. Height (45° Discharge) | Overall Length | Maximum Height | Dig Below Ground | Concrete Level | Carry Position |
| 2¼ cu. yd. (2.10 m³) | 47.68 in. (1.21 m) | 67 in. (1.70 m) | 126 in. (3.20 m) | 236 in. (5.98 m) | 212 in. (5.38 m) | 5 in. (127 mm) | 40° | 48° |
| 3¼ cu. yd. (2.48 m³) | 51.46 in. (1.31 m) | 65 in. (1.80 m) | 122 in. (3.10 m) | 240 in. (6.10 m) | 218 in. (5.54 m) | 5 in. (127 mm) | 40° | 48° |
| 2¼ cu. yd. (2.10 m³) Multipurpose | 47.02 in. (1.19 m) | 67 in. (1.70 m) | 121 in. (3.07 m) | 238 in. (6.05 m) | 206 in. (5.23 m) | 9 in. (229 mm) | 34° | 48° |

T93383

CRAWLER LOADER OPERATING INFORMATION

| OPERATING INFORMATION | BUCKET | | |
|---|---|---|---|
| | General Purpose | General Purpose | Multipurpose |
| Capacity, heaped, SAE | 2-3/4 cu. yd. (2.10 m ³) | 3-1/4 cu. yd. (2.48 m ³) | 2-3/4 cu. yd. (2.10 m ³) |
| Capacity, struck, SAE | 2.30 cu. yd. (1.76 m ³) | 2.74 cu. yd. (2.10 m ³) | 2.07 cu. yd. (1.58 m ³) |
| Bucket width | 96.2 in. (2.44 m) | 96.2 in. (2.44 m) | 96.2 in. (2.44 m) |
| Bucket weight | 3000 lb. (1361 kg) | 3200 lb. (1451 kg) | 3600 lb. (1633 kg) |
| SAE breakout force | 40,100 lb. (180 kN) (18 189 kg) | 35,000 lb. (157 kN) (15 876 kg) | 36,900 lb. (165 kN) (16 738 kg) |
| SAE tipping load (w/drawbar, 3 counterweights and ROPS) | 35,200 lb. (15 966 kg) | 35,000 lb. (15 876 kg) | 34,600 lb. (15 695 kg) |
| Raising time | 6.7 sec. | 6.7 sec. | 6.7 sec. |
| Dumping time | 1.5 sec. | 1.5 sec. | 1.5 sec. |
| Lowering time | 3.7 sec. | 3.7 sec. | 3.7 sec. |
| SAE operating weight w/ROPS canopy | 48,400 lb. (21 954 kg) | 49,600 lb. (22 500 kg) | 50,000 lb. (22 680 kg) |
| SAE operating weight w/cab | 48,800 lb. (22 136 kg) | 50,000 lb. (22 680 kg) | 50,400 lb. (22 861 kg) |

| Adjustments to operating weights and tipping loads: | | |
|---|----------------------------|----------------------------|
| Add (+) or deduct (-) lb. (kg) as indicated for loader equipped with: | Loader Operating Weight | Tipping Load |
| Cab | +400 lb. (181 kg) | +534 lb. (242 kg) |
| Bucket teeth, bolt-on | + or - 310 lb. (141 kg) | + or - 340 lb. (154 kg) |
| Bucket teeth, flush mounted, weld-on | + or - 320 lb. (145 kg) | + or - 350 lb. (159 kg) |
| Air conditioning | +109 lb. (49 kg) | +30 lb. (14 kg) |
| Ripper (w/o drawbar and 3 counterweights) | +1471 lb. (667 kg) | +3461 lb. (1570 kg) |
| Counterweight (each) | + or - 500 lb. (227 kg) | + or - 967 lb. (439 kg) |

STEEL MILL LOADER

Specifications and design subject to change without notice. Wherever applicable, specifications are in accordance with ICED and SAE Standards. Except where otherwise noted, these specifications are based on a unit equipped with 2-1/2 cu. yd. (1.91 m³) Asbury slag bucket, roll-over protective canopy, four counterweights, full fuel tank, 175 lb. (79 kg) operator and steel mill special equipment.

| Power (@ 1800 rpm): | SAE | DIN |
|---------------------|------------------|--------|
| Gross | 220 hp (164 kW*) | |
| Net | 200 hp (149 kW) | 203 PS |

Net engine flywheel power is for an engine equipped with fan, air cleaner, water pump, lubricating oil pump, fuel pump, alternator and muffler. The gross engine power is without fan. Flywheel power ratings are under SAE standard conditions of 500 ft. (150 m) altitude and 85°F (29.5°C) temperature, and DIN 6270 conditions (non-corrected). No derating is required up to 7500 feet (2 266 m) altitude.

* In the International System of units (SI), power is expressed in kilowatts (kW).

Engine:

John Deere 6-cylinder turbocharged and intercooled diesel, valve-in-head, 4-stroke cycle.

| | |
|---|--|
| Bore and stroke | 5.12 x 5 in. (130 x 127 mm) |
| Piston displacement | 619 cu. in. (10 147 cm ³) |
| Compression ratio | 15.2 to 1 |
| Maximum torque @ 1300 rpm . . | 730 lb-ft (990 N·m) (101 kg-m) |
| NACC or AMA (U.S. Tax) horsepower | 62.9 |
| Lubrication | Pressure system with full flow filters |
| Main bearings | 7 |
| Cooling | Pressurized with thermostat and controlled bypass |
| Fan | Blower |
| Dual stage aspirated air cleaner | Dry |
| Electrical system | 24 volt with alternator |
| Batteries, (2 12-volt) | Reserve capacity: 180 minutes each |

Transmission:

Cold weather starting disconnect clutch completely disengages hydrostatic drive and all hydraulics.

Splitter drive Pressure-lubricated helical gears drive both hydrostatic transmissions, main hydraulic pump, winch drive shaft and auxiliary pump drive.

Drive Dual-path, full automatic, infinitely variable hydrostatic transmissions.

Speeds . . Infinite from 0 to 6.5 mph (0 to 10.5 km/h) forward or reverse.

Control Single-lever, variable speed, forward and reverse.

Cooling Oil to air cooler

Steering:

Fully modulated infinitely variable pedal steering for live power turns and counterrotation. No need for steering clutches or steering brakes.

Brakes:

Service Hydrostatic

Parking Wet-disk brakes are automatically applied when engine is stopped, or manually applied with center pedal during normal operation.

Hydraulic System: Open Center

Control Single-lever bucket control with float position

Valve Three-function

Oil lines Seamless steel tubing; double-wire-braid hose, heat resistant hose covering on exposed bucket hoses, main pressure hose and oil cooler hose

Hydraulic System: Oil Fill

Pump Vane, 70 gpm (4.42 L/s) @ rated engine speed
 Pressure 2600 psi (17 927 kPa) (183 kg/cm²)
 Filter 10 micron filter in return line w/bypass
 Cooling Dual oil to air coolers

Optional Water-Glycol Fill:

Pump Gear, 64.4 gpm (4.06 L/s) @ rated engine speed
 Pressure 2600 psi (17 927 kPa) (183 kg/cm²)
 Filter 15 micron for water-glycol
 Cooling Dual fluid to air coolers
 Warning system Gauge and audio alarm
 Cylinders Glycol compatible seals

Hydraulic Cylinders: Boom and bucket cylinders equipped with rod guide guards

| | Bore | Stroke |
|----------------|-------------------|-------------------|
| Boom (2) . . . | 6.25 in. (159 mm) | 38.1 in. (965 mm) |
| Bucket (2) . . | 5.50 in. (140 mm) | 26.1 in. (663 mm) |

Cylinder rods . . Ground, heat-treated, chrome-plated, polished
 Boom cylinder rods 4.00 in. (102 mm) dia.
 Bucket cylinder rods 3.75 in. (95 mm) dia.

Tracks: Reinforced 7-roller track frame with weld-on front and rear track guides and sprocket guard. DURA-TRAX™ deep-heat-treated sealed track links and through-hardened sealed rollers provide maximum wear resistance.

Grouser (flat shoe) 16 in. (406 mm)
 Track shoes, each side 39
 Ground contact area 3552 sq. in. (22 916 cm²)
 Ground pressure 15.45 psi (106.5 kPa) (1.09 kg/cm²)
 Length of track on ground 111 in. (2.82 m)
 Track gauge 76 in. (1.93 m)
 Track rollers 7/w heat-resistant seals
 Carrier rollers 2 each side w/heat-resistant seals
 Adjustment Hydraulic w/high-temperature seals
 Minimum ground clearance 16.6 in. (422 mm)

Capacities:

| | U.S. | Liters |
|---|-----------|--------|
| Cooling system | 10.5 gal. | 39.8 |
| Fuel tank | 106 gal. | 401.2 |
| Crankcase, including filters | 36.5 qt. | 34.5 |
| Splitter drive | 1.5 gal. | 5.7 |
| Final drive, each: | | |
| 1st reduction | 5.25 gal. | 20.0 |
| 2nd reduction | 3.5 gal. | 13.2 |
| Loader hydraulic system, oil or water-glycol fill | 40 gal. | 151.4 |
| Hydrostatic drives | 46 gal. | 174.1 |

SAE Operating Weight w/ROPS, 2.5 cu. yd. (1.91 m³)
 Slag Bucket and Steel Mill
 Special Equipment 54,900 lb. (24 900 kg)

STEEL MILL LOADER DIMENSIONS

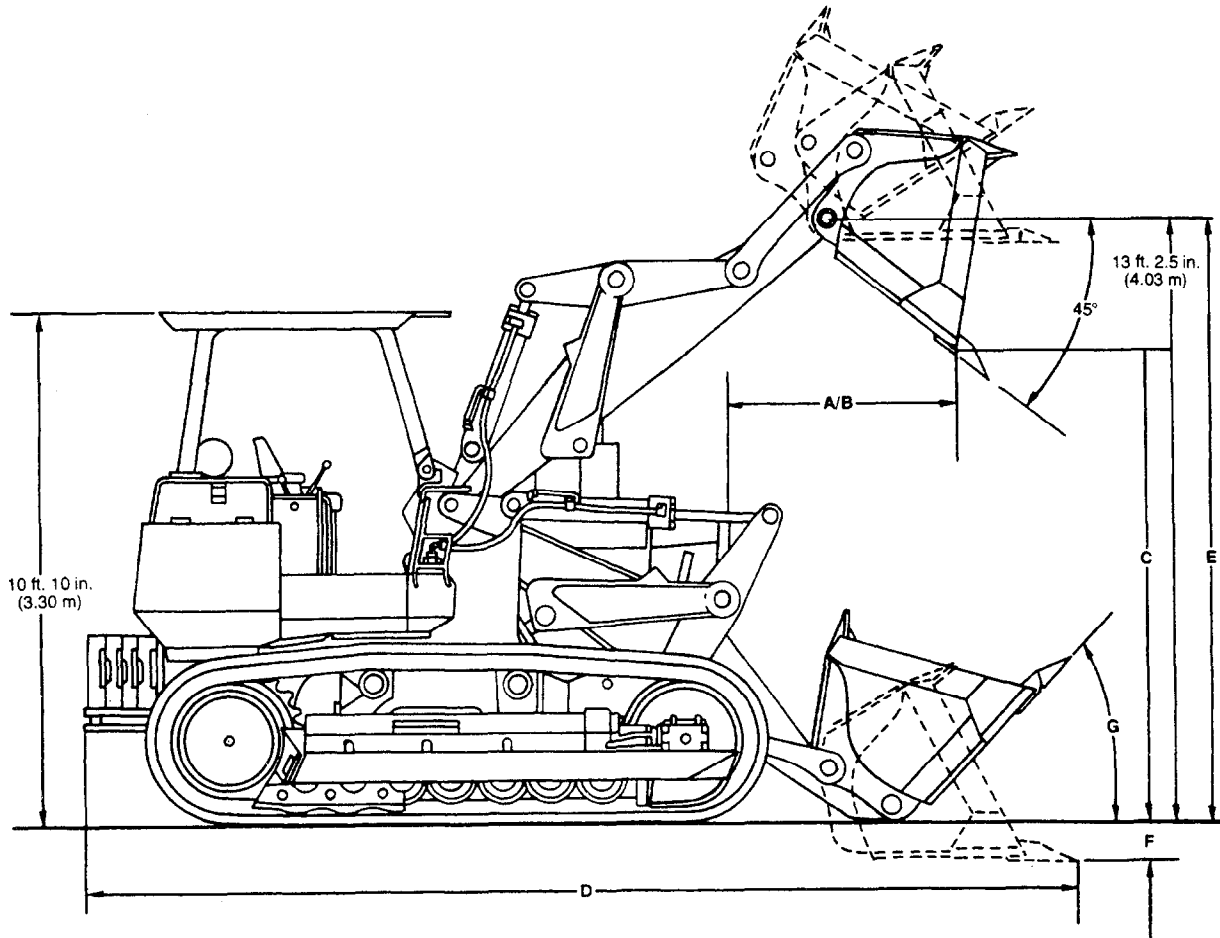

| BUCKET CAPACITIES | DIMENSIONS | | | | | | Rollback Angle | |
|--|--------------------------------------|---|---|------------------|--------------------|------------------|----------------|----------------|
| | A | B | C | D | E | F | G | |
| | Reach at Max. Height (45° Discharge) | Reach at 7 ft. (2.13 m) Clearance (45° Discharge) | Dump Clearance at Max. Height (45° Discharge) | Overall Length | Maximum Height | Dig Below Ground | Concrete Level | Carry Position |
| 2.5 cu. yd. (1.91 m ³) Slag Bucket | 50 in. (1.27 m) | 63.5 in. (1.61 m) | 123.5 in. (3.14 m) | 245 in. (6.22 m) | 215.5 in. (5.47 m) | 5 in. (127 mm) | 40° | 48° |

T92999

STEEL MILL LOADER OPERATING INFORMATION



| OPERATING INFORMATION | SLAG BUCKET |
|--|---|
| Capacity, heaped, SAE | 2-1/2 cu. yd. (1.91 m ³) |
| Capacity, struck, SAE | 2.12 cu. yd. (1.62 m ³) |
| Bucket width | 96.2 in. (2.44 m) |
| Bucket weight, with teeth | 4900 lb. (2223 kg) |
| SAE breakout force | 36,200 lb. (160 kN) (16 420 kg) |
| SAE tipping load (w/drawbar, four counterweights and ROPS) | 35,000 lb. (15 876 kg) |
| Lift capacity to full height | 17,600 lb. (7 983 kg) |
| Raising time | 6.7 sec. |
| Dumping time | 1.5 sec. |
| Lowering time | 3.7 sec. |
| SAE operating weight w/ROPS canopy | 54,900 lb. (24 903 kg) |

CUSTOMARY HARDWARE TORQUE SPECIFICATIONS

Check all cap screws and nuts, which can be easily reached, to be sure they are tight. If hardware is loose, tighten it to torque shown on chart below unless a special torque is specified.

NOTE: Torques shown are for dry (no lubrication on threads) hardware.

NOTE: Torque wrench tolerance is ± 10 percent of specified torque.

| Cap Screw Size-Inches | Customary Hardware | | |
|--------------------------|---|---|---|
| |  Grade B |  Grade D |  Grade F |
| | lb-ft. (N-m) | lb-ft. (N-m) | lb-ft. (N-m) |
| 1/4 | ----- | 10 (14) | 14 (19) |
| 5/16 | ----- | 20 (27) | 30 (41) |
| 3/8 | ----- | 35 (47) | 50 (68) |
| 7/16 | 35 (47) | 55 (75) | 80 (108) |
| 1/2 | 55 (75) | 85 (115) | 120 (163) |
| 9/16 | 75 (102) | 130 (176) | 175 (237) |
| 5/8 | 105 (142) | 170 (230) | 240 (325) |
| 3/4 | 185 (251) | 300 (407) | 425 (576) |
| 7/8 | 160 (217) | 445 (603) | 685 (929) |
| 1 | 250 (339) | 670 (908) | 1030 (1396) |
| 1-1/8 | 330 (447) | 910 (1234) | 1460 (1979) |
| 1-1/4 | 480 (651) | 1250 (1695) | 2060 (2793) |

T88884

METRIC HARDWARE TORQUE SPECIFICATIONS

NOTE: Torques shown are for hardware with SAE 30W oil on threads.

NOTE: Torque wrench tolerance is ± 10 percent of specified torque.

Metric Standard Thread

| Thread | 8.8 | | 10.9 | | 12.9 | |
|--------|-------|---------|-------|---------|--------|---------|
| | N·m | (lb-ft) | N·m | (lb-ft) | N·m | (lb-ft) |
| M5 | 5.9 | (4.4) | 7.9 | (5.8) | 9.8 | (7.2) |
| M6 | 9.8 | (7.2) | 13.8 | (10.2) | 16.7 | (12.3) |
| M8 | 24.6 | (18.1) | 34.4 | (25.4) | 40.2 | (29.6) |
| M10 | 48.1 | (35.5) | 67.8 | (50.0) | 81.5 | (60.1) |
| M12 | 84.4 | (62.2) | 118.0 | (87.0) | 142.0 | (105.0) |
| M14 | 133.0 | (98.0) | 187.0 | (138.0) | 226.0 | (167.0) |
| M16 | 206.0 | (152.0) | 290.0 | (214.0) | 348.0 | (257.0) |
| M18 | 285.0 | (210.0) | 398.0 | (294.0) | 476.0 | (351.0) |
| M20 | 402.0 | (296.0) | 570.0 | (420.0) | 677.0 | (499.0) |
| M22 | 540.0 | (398.0) | 765.0 | (564.0) | 914.0 | (674.0) |
| M24 | 697.0 | (514.0) | 980.0 | (723.0) | 1180.0 | (870.0) |

Metric Fine Thread

| Thread | 8.8 | | 10.9 | | 12.9 | |
|-----------|--------|---------|--------|----------|--------|----------|
| | N·m | (lb-ft) | N·m | (lb-ft) | N·m | (lb-ft) |
| M8 x 1 | 26.5 | (19.5) | 37.3 | (27.5) | 44.2 | (32.6) |
| M10 x 1 | 47.1 | (34.7) | 68.8 | (50.7) | 81.5 | (60.1) |
| M12 x 1.5 | 88.4 | (65.2) | 123.0 | (91.0) | 147.0 | (108.0) |
| M14 x 1.5 | 147.0 | (108.0) | 206.0 | (152.0) | 246.0 | (181.0) |
| M16 x 1.5 | 221.0 | (163.0) | 309.0 | (228.0) | 373.0 | (275.0) |
| M18 x 1.5 | 319.0 | (235.0) | 451.0 | (333.0) | 540.0 | (398.0) |
| M20 x 1.5 | 451.0 | (333.0) | 628.0 | (463.0) | 755.0 | (557.0) |
| M22 x 1.5 | 599.0 | (442.0) | 845.0 | (623.0) | 1030.0 | (760.0) |
| M24 x 2 | 765.0 | (564.0) | 1080.0 | (796.0) | 1275.0 | (940.0) |
| M26 x 2 | 1130.0 | (833.0) | 1570.0 | (1158.0) | 1915.0 | (1412.0) |

O-RING BOSS FITTING SERVICE RECOMMENDATIONS

1. Inspect boss O-ring seat. It must be free of dirt and defects. If repeated leaks occur, inspect for defects with a magnifying glass. Some raised defects can be removed with a slip stone.

Occasionally a lower durometer O-ring will seal against a rough seat. If neither of these solutions work, the component must be replaced.

2. Put hydraulic oil, petroleum jelly or soap on the O-ring. Put a thimble over the threads to protect O-ring from nicks. Slide O-ring over the thimble and into the turned down section of fitting.

For angle fittings, loosen special nut and push special washer against threads so O-ring can be installed into the turned down section of fitting.

3. Turn fitting into the boss by hand until special washer or washer face (straight fitting) contacts boss face and O-ring is squeezed into its seat.

4. To position angle fittings, turn the fitting counterclockwise a maximum of one turn.

5. Tighten straight fittings to the torque value shown in chart. For angle fittings, tighten the special nut to value shown in the chart while holding body of fitting with a wrench.

STRAIGHT FITTING OR SPECIAL NUT TORQUE (1)

| Thread Size | Torque ¹ | | Number Of |
|----------------|---------------------|---------|--------------------|
| | N·m | (lb-ft) | Flats ² |
| 3/8-24 UNF | 8 | (6) | 2 |
| 7/16-20 UNF | 12 | (9) | 2 |
| 1/2-20 UNF | 16 | (12) | 2 |
| 9/16-18 UNF | 24 | (18) | 2 |
| 3/4-16 UNF | 46 | (34) | 2 |
| 7/8-14 UNF | 62 | (46) | 1-1/2 |
| 1-1/16-12 UN | 102 | (75) | 1 |
| 1-3/16-12 UN | 122 | (90) | 1 |
| 1-5/16-12 UN | 142 | (105) | 3/4 |
| 1-5/8-12 UN | 190 | (140) | 3/4 |
| 1-7/8-12 UN | 217 | (160) | 1/2 |

1. Tolerance \pm 10%.

2. To be used if a torque wrench cannot be used. After tightening fitting by hand, put a mark on nut and boss; then tighten special nut or straight fitting the number of flats shown.

TUBE AND HOSE FITTING, 37° FLARE AND 30° CONE SEAT CONNECTOR SERVICE RECOMMENDATIONS

1. Inspect the flare and the flare seat. They must be free of dirt and defects. If repeated leaks occur, inspect for defects with a magnifying glass. If burrs and raised nicks on the connector body cannot be removed with a slip stone, replace the connector.

2. Defects in the tube flare cannot be repaired. Replace the tube. Overtightening a defective flared fitting will not stop leaks.

3. As a field repair, a ductile truncated cone shaped washer can be used between the tube flare and connector body. These washers are soft enough to fill defects in the seat and flare. They will also seal the connection. Ductile washers are available from industrial supply houses.

4. Align the tube with the fitting before attempting to start the nut. Failure to do so can cause a deformed flare and subsequent leaks. Install hoses without twists. A twisted hose attempts to straighten out when pressure is applied. This exerts a torque on the connection, eventually causing failure.

5. Lubricate the connection with hydraulic fluid, petroleum jelly or soap. Tighten the swivel nut by hand until it is snug.

6. Mark a line across the nut and connector body. This line will serve as a visual indicator as to whether the nut has been tightened and by how much.

7. Using two wrenches, one on the connector body and a torque wrench on the nut, tighten the nut to the torque value as shown in the chart. In the case of a hose, it may be necessary to use three wrenches to prevent twisting.

TUBE AND HOSE FITTING, 37° FLARE AND 30° CONE SEAT CONNECTOR TORQUE

| Thread Size | N·m | Torque ¹ (lb-ft) | New ² Number of Flats | Used ³ Number of Flats |
|--------------|-----|-----------------------------|----------------------------------|-----------------------------------|
| 3/8-24 UNF | 8 | (6) | 2-1/2 | 1 |
| 7/16-20 UNF | 12 | (9) | 2-1/2 | 1 |
| 1/2-20 UNF | 16 | (12) | 2-1/2 | 1 |
| 9/16-18 UNF | 24 | (18) | 2 | 1 |
| 3/4-16 UNF | 46 | (34) | 2 | 1 |
| 7/8-14 UNF | 62 | (46) | 1-1/2 | 1 |
| 1-1/16-12 UN | 102 | (75) | 1 | 3/4 |
| 1-3/16-12 UN | 122 | (90) | 1 | 3/4 |
| 1-5/16-12 UN | 142 | (105) | 3/4 | 3/4 |
| 1-5/8-12 UN | 190 | (140) | 3/4 | 3/4 |
| 1-7/8-12 UN | 217 | (160) | 1/2 | 1/2 |

1. Tolerance of ± 10%.

2. To be used if a torque wrench cannot be used. After tightening fitting by hand, put a mark across the fittings, then tighten fitting the number of flats shown.

3. Flare connection seal by deforming or squeezing the tube between the nut and the connector. More deformation is possible with new parts than with old. Therefore, if a torque wrench is not used for re-assembly, the values in this column must be used to prevent damage.

SAE FOUR BOLT FLANGE FITTING SERVICE RECOMMENDATIONS

1. Inspect the sealing surfaces for nicks or scratches, roughness or out-of-flat condition. Scratches cause leaks. Roughness causes seal wear. Out-of-flat causes seal extrusion. If these defects cannot be polished out, replace the component.

2. Install the correct O-ring (and backup washer if required) into the groove using petroleum jelly to hold it in place.

3. For split flange; loosely assemble split flange halves, being sure that the split is centrally located and perpendicular to the port. Hand tighten cap screws to hold parts in place. Do not pinch O-ring.

4. For single piece flange; put hydraulic line in the center of the flange and install four cap screws. With the flange centrally located on the port, hand tighten cap screws to hold it in place. Do not pinch O-ring.

5. For both single piece flange and split flange, be sure the components are properly positioned and cap screws are hand tight. Tighten one cap screw, then tighten the diagonally opposite cap screw. Tighten the two remaining cap screws. Tighten all cap screws within the specified limits shown in the chart.

DO NOT use air wrenches. DO NOT tighten one cap screw fully before tightening the others. DO NOT over-tighten.

SAE FOUR BOLT FLANGE FITTING TORQUE

| Nominal Flange Size | Cap Screw Size ¹ | Torque ² | | | |
|------------------------|--------------------------------|---------------------|------|---------|-------|
| | | N·m | | (lb-ft) | |
| | | Min. | Max. | Min. | Max. |
| 1/2 | 5/16 - 18 UNC | 20 | 31 | (15) | (23) |
| 3/4 | 3/8 - 16 UNC | 28 | 54 | (21) | (40) |
| 1 | 3/8 - 16 UNC | 37 | 54 | (27) | (40) |
| 1-1/4 | 7/16 - 14 UNC | 47 | 85 | (35) | (63) |
| 1-1/2 | 1/2 - 13 UNC | 62 | 131 | (46) | (97) |
| 2 | 1/2 - 13 UNC | 73 | 131 | (54) | (97) |
| 2-1/2 | 1/2 - 13 UNC | 107 | 131 | (79) | (97) |
| 3 | 5/8 - 11 UNC | 158 | 264 | (117) | (195) |
| 3-1/2 | 5/8 - 11 UNC | 158 | 264 | (117) | (195) |
| 4 | 5/8 - 11 UNC | 158 | 264 | (117) | (195) |
| 5 | 5/8 - 11 UNC | 158 | 264 | (117) | (195) |

1. SAE Grade 5 or better cap screws with plated hardware.

2. Tolerance $\pm 10\%$. The torques given are enough for the given size connection with the recommended working pressure. Torques can be increased to the maximum shown for each cap screw size if desired. Increasing cap screw torque beyond this maximum will result in flange and cap screw bending and connection failures.

O-RING FACE SEAL FITTING SERVICE RECOMMENDATIONS

1. Inspect the sealing surfaces for nicks or scratches, roughness, or out-of-flat condition. Scratches cause leaks. Roughness causes seal wear. Out-of-flat causes seal extrusion. If these defects cannot be polished out, replace the component.

2. Lubricate O-ring and male threads with petroleum jelly.

For O-ring face seal fittings, push O-ring into groove.

For O-ring boss fittings, put a thimble over the threads to protect O-ring from nicks. Slide O-ring over the thimble and into the turned down section of fitting.

For angle fittings, loosen special nut and push special washer against threads so O-ring can be installed into the turned down section of fitting.

3. Install fitting and hand tighten until snug. To position angle fittings, turn fitting counterclockwise a maximum of one turn.

4. Tighten fitting for nut to the torque value shown in chart per dash size stamped on fitting.

Use one wrench to hold connector body and another wrench to tighten nut. When tightening a fitting on a hose, it may be necessary to use three wrenches to prevent twisting hose; one on the connector body, one on the nut, and one on the body of the hose fitting.

O-RING FACE SEAL FITTING TORQUE (1)

| Nominal | | | Thread Size in. | O-Ring Face Seal End | | | | O-Ring Boss End | | |
|---------|----------|-----------|-----------------|----------------------|-------|---------------------|-------|-----------------|------------------------------------|-------|
| Tube mm | O.D. in. | Dash Size | | Swivel Nut Torque | | Bulkhead Nut Torque | | Thread Size in. | Straight Fitting or Jam Nut Torque | |
| | | | | N·m | lb-ft | N·m | lb-ft | | N·m | lb-ft |
| 4.76 | 0.188 | -3 | — — — | — | — | — | — | 3/8-24 | 8 | 6 |
| 6.35 | 0.250 | -4 | 9/16-18 | 16 | 12 | 5.0 | 3.5 | 7/16-20 | 12 | 9 |
| 7.94 | 0.312 | -5 | — — — | — | — | — | — | 1/2-20 | 16 | 12 |
| 9.52 | 0.375 | -6 | 11/16-16 | 24 | 18 | 9.0 | 6.5 | 9/16-18 | 24 | 18 |
| 12.70 | 0.500 | -8 | 13/16-16 | 50 | 37 | 17.0 | 12.5 | 3/4-16 | 46 | 34 |
| 15.88 | 0.625 | -10 | 1-14 | 69 | 51 | 17.0 | 12.5 | 7/8-14 | 62 | 46 |
| 19.05 | 0.750 | -12 | 1-3/16-12 | 102 | 75 | 17.0 | 12.5 | 1-1/16-12 | 102 | 75 |
| 22.22 | 0.875 | -14 | 1-3/16-12 | 102 | 75 | 17.0 | 12.5 | 1-3/16-12 | 122 | 90 |
| 25.40 | 1.000 | -16 | 1-7/16-12 | 142 | 105 | 17.0 | 12.5 | 1-5/16-12 | 142 | 105 |
| 31.75 | 1.250 | -20 | 1-11/16-12 | 190 | 140 | 17.0 | 12.5 | 1-5/8-12 | 190 | 140 |
| 38.10 | 1.500 | -24 | 2-12 | 217 | 160 | 17.0 | 12.5 | 1-7/8-12 | 217 | 160 |

1. Tolerance: +15-20%.

Group IV PREDELIVERY, DELIVERY, AND AFTER-SALE SERVICES

TEMPORARY STORAGE

After receiving your crawler from the factory and before putting the machine into temporary storage perform the following checks:

1. Check battery electrolyte level and charge the battery, if necessary.
2. Check coolant level in the radiator. Coolant level should be maintained at a level midway between the radiator core and filler neck.
3. Fill the fuel tank.
4. Check crankcase oil level. Oil should be at top mark of dipstick after crawler has been shut down for 10 minutes.
5. Relieve hydraulic pressure by stopping engine, lowering all equipment and operating control levers until system fails to respond.

PREDELIVERY SERVICE

Because of the shipping factors involved, plus extra finishing touches that are necessary to promote customer satisfaction, proper predelivery service is of prime importance to the dealer and the customer.

If adjustments are required, procedures are found in the After-Sale section.

Use the following list when preparing a unit for delivery to the customer.

1. Air Cleaner

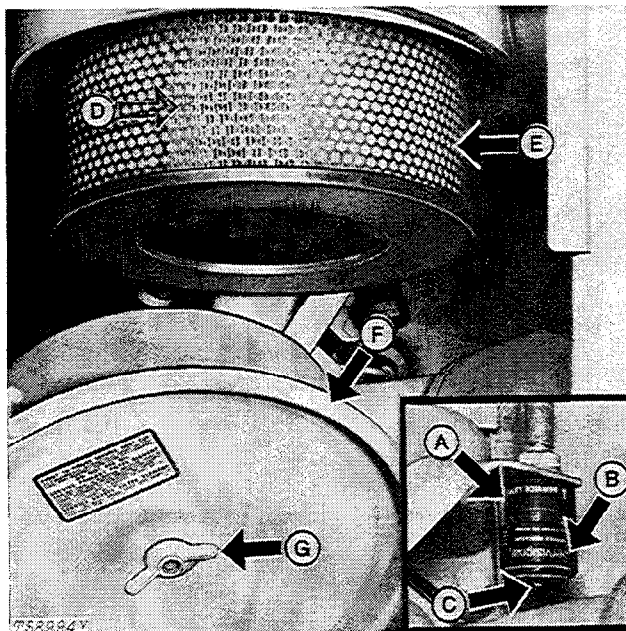

- A—Red Signal
- B—Restriction Indicator
- C—Reset Button
- D—Safety Element
- E—Primary Element
- F—Cover
- G—Wing Nut

Fig. 1—Air Cleaner

Check air cleaner restriction indicator. If red signal locks in full view, look for restriction or blockage in air intake system.

| | | |
|------------------------------|-----|----|
| Air cleaner elements checked | Yes | No |
| Restriction in system | Yes | No |

2. Fuel Filters

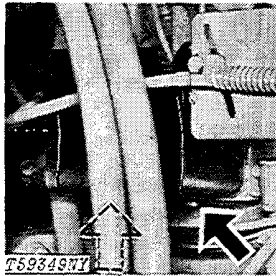

T59349NY

Fig. 2-Drain Plugs

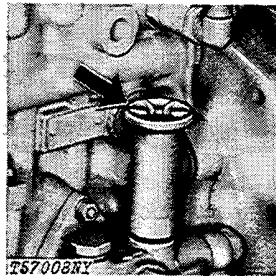

T57008NY

Fig. 3-Hand Primer

Check fuel filters for sediment. Drain if necessary. To drain:

- 1 - Loosen drain plugs.
- 2 - Turn hand primer counterclockwise to loosen.
- 3 - Pull hand primer up and pump the primer until a solid stream of fuel, free from air bubbles, flows from the drain plug holes.
- 4 - Tighten drain plugs.
- 5 - Bleed fuel system as follows:
 - A - Loosen bleed plug.
 - B - Turn hand primer counterclockwise to loosen.
 - C - Pull hand primer up and pump the primer until a solid stream of fuel, free from air bubbles, flows from the bleed plug.
 - D - Tighten bleed plug.
 - E - Push hand primer down completely and hand tighten. Turn knob clockwise to tighten.

Sediment present in filters Yes No

3. Air Intake Hose

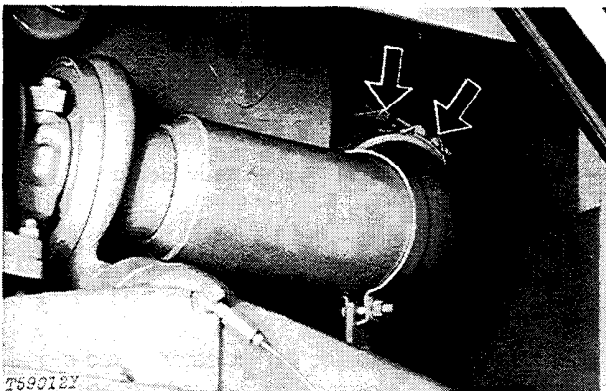

T59012Y

Fig. 4-Air Intake Hose Connections

Check clamps on hose connecting air cleaner and engine. Tighten two hose clamps. Inspect hose for cracks.

Air intake hose checked Yes No
 Loose connections Yes No

4. Batteries

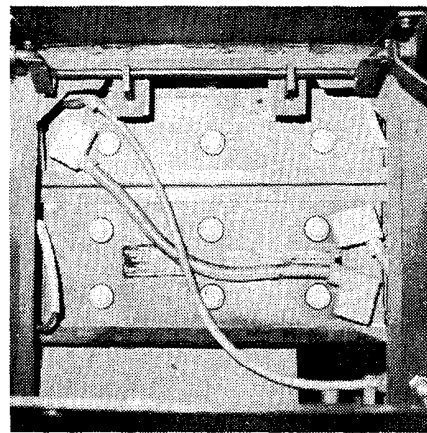

T88963

Fig. 5-Batteries

Check battery electrolyte level. If distilled water is not available, use clean soft water. Avoid use of hard water. Remove foreign material from top of battery and coat terminals with petroleum jelly.

IMPORTANT: Never add water to battery in freezing weather unless engine is to be run 2 or 3 hours to assure mixing of water and electrolyte.

Check battery connections.

Punch date code on battery.

| | | |
|--------------------------------|-----|----|
| Water added | Yes | No |
| Batteries checked and serviced | Yes | No |

5. Fuel Tank

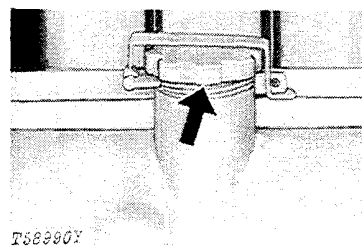

T58880Y

Fig. 6-Fuel Tank

Check fuel tank level. If low, add sufficient fuel to fill the tank. Capacity is 106 gal. (401.3 L). Check fuel system for leaks.

| | | | |
|-----------------|------|----------|-------|
| Fuel tank level | Full | 1/2-Full | Empty |
|-----------------|------|----------|-------|

6. Fuel Tank Sump

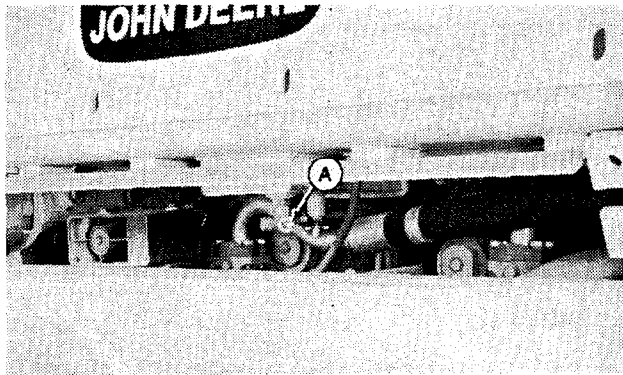

Fig. 7-Drain Cock

Drain sump after crawler has been stopped for at least 2 hours.

To drain sump:

- 1 - Loosen cap screws on access cover and pivot cover down.
- 2 - Open drain cock (A).
- 3 - Drain fuel until it is clear of water, dirt, etc.
- 4 - Close drain cock.
- 5 - Replace access cover and tighten cap screws.

| | | |
|------------------------|-----|----|
| Fuel tank sump checked | Yes | No |
| Fuel tank sump drained | Yes | No |

7. Radiator

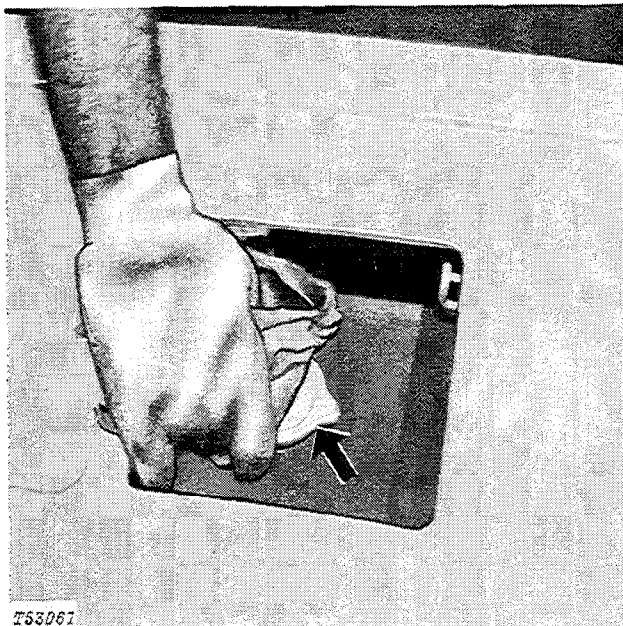

Fig. 8-Radiator Filler Cap

CAUTION: Do not remove radiator filler cap until coolant temperature is below its boiling point. Then loosen cap slowly to the stop to relieve any excess pressure before removing cap completely.

Litho in U.S.A.

Check coolant level in radiator. When engine is cold, coolant should be at the bottom of the filler neck. Add permanent type antifreeze if cold weather is expected. If coolant level is low, check cooling system for leaks.

Do not use methoxy propanol antifreeze (such as Dowtherm 209 antifreeze or its equivalent) in the coolant solution. It may damage the cylinder sleeves and seals. This antifreeze is also not compatible with either the Precharge or Service Filter.

Check to make sure the two shut-off valves on both sides of the engine coolant conditioner-filter are opened completely.

| | | |
|--------------------------------|-----|----|
| Radiator coolant level checked | Yes | No |
| Coolant or antifreeze added | Yes | No |

8. Crankcase Oil Level

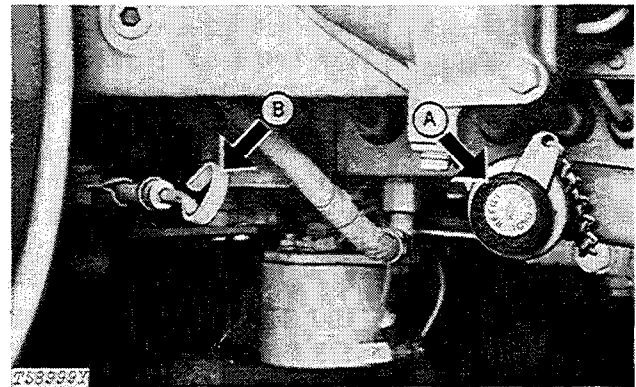

A—Oil Filler Cap

B—Dipstick

Fig. 9-Crankcase Oil Level

Check crankcase oil level with unit on level ground and engine shut off. Wait 10 minutes for oil to drain into oil pan. If oil level is at or below bottom mark on dipstick, add sufficient oil of the proper viscosity and type specified in the Lubrication section to bring oil level to between marks on dipstick. Do not operate engine with oil level below the bottom mark.

| | | |
|-----------------------------|-----|----|
| Crankcase oil level checked | Yes | No |
| Oil added | Yes | No |

9. Front Idlers, Track Rollers and Carrier Rollers Oil Levels

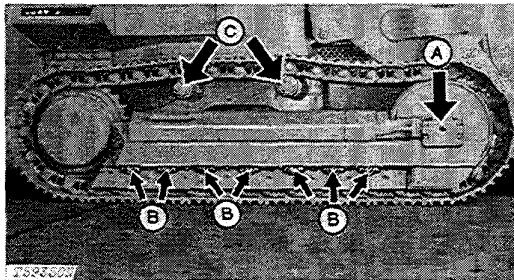

A—Front Idler Check Plug C—Carrier Rollers Check Plugs
 B—Track Roller Check Plugs

Fig. 10-Track Area Oil Levels

Check oil level in the carrier rollers. Oil level should be at check plug. If low, add oil specified in the Lubrication section to bring level up to check plug.

Check oil level in the front idlers and track rollers as follows:

- 1 - Thoroughly clean the JD-313 tool and area around the plug. Check O-ring for cuts and replace as necessary. Grease O-ring for easy entry past threads of shaft I.D.
- 2 - Remove plug and O-ring.
- 3 - Using a JD-313 Lube Nozzle Kit, insert the nozzle in the shaft as far as it will go.
- 4 - Force oil specified in the Lubrication section into the shaft until oil flows out.
- 5 - Remove the nozzle and install plug with O-ring.

| | | |
|---|-----|----|
| Front idler, track roller and carrier roller oil levels checked | Yes | No |
| Oil added | Yes | No |

10. Splitter Gearbox Oil Level

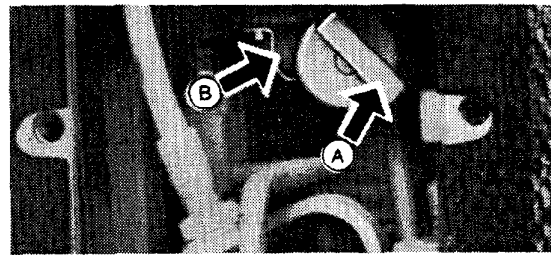

A—Dipstick B—Filler Tube

Fig. 11-Splitter Gearbox Oil Level

The filler tube and dipstick are located on the rear of the splitter housing under the floorboard plate.

IMPORTANT: Do not overfill. Overfilling may cause over heating.

Park crawler on a level surface and stop the engine.

Remove dipstick. Oil level should be between marks on the dipstick. If oil level is low, fill with oil specified in the Lubrication section.

Replace dipstick. Do not overtighten dipstick.

| | | |
|------------------------------------|-----|----|
| Splitter gearbox oil level checked | Yes | No |
| Oil added | Yes | No |

11. Inner and Outer Final Drive Housing Oil Level

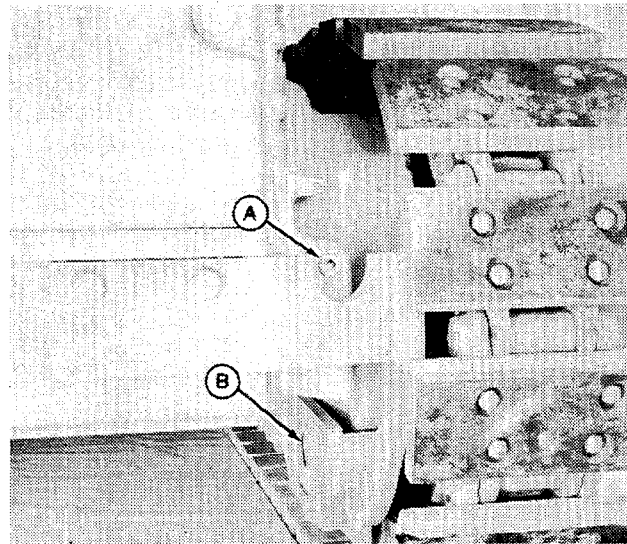

A—Level-Filler Plug B—Drain Plug

Fig. 12-Inner Final Drive Housing

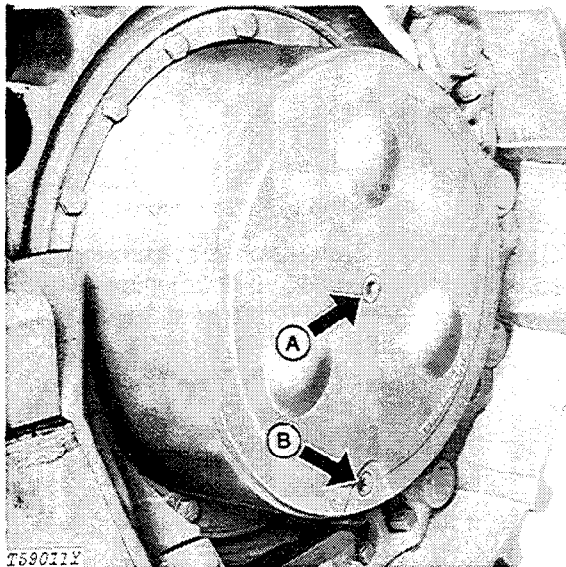

A—Level-Filler Plug B—Drain Plug

Fig. 13-Outer Final Drive Housing

Check the oil levels of the inner and outer final drive housings. Oil level should be at level-filler plug. If low, add enough oil specified in the Lubrication section to bring level up to check and fill plug.

| | | |
|---|-----|----|
| Inner and outer final drive housing oil level checked | Yes | No |
| Oil added | Yes | No |

12. Hydrostatic Transmission Oil Level

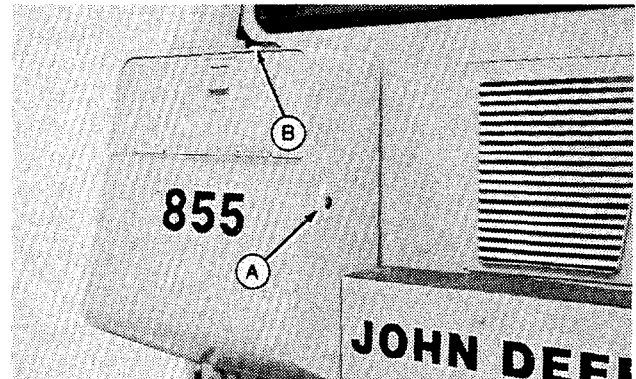

A—Oil Level Window B—Fill Plug

Fig. 14-Transmission Sump

Park the crawler on a level surface and stop the engine.

Transmission oil level should be halfway up in oil level window.

CAUTION: The hydrostatic transmission system is a sealed design and has no vent. Remove filler plug slowly to release pressure. When replacing the filler plug, be sure it is screwed down tight and the O-ring is in good condition.

If oil is not visible in window, add oil specified in the Lubrication section to bring up to this level. Check transmission system for leaks if oil level is low.

| | | |
|--------------------------------|-----|----|
| Transmission oil level checked | Yes | No |
| Oil added | Yes | No |

13. Hydraulic System Oil Level

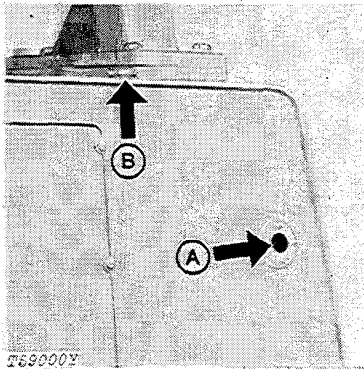

A—Oil Level Window B—Fill Plug

Fig. 15-Hydraulic Reservoir

Check oil level with crawler on a level surface, bucket on ground, and ripper (if equipped) in transport position. Stop the engine.

Hydraulic oil level should be visible in oil level window.

CAUTION: The hydraulic reservoir is completely closed and pressurized. Slowly remove the fill plug to relieve the reservoir pressure. When replacing the fill plug, be sure it is screwed down tight and the O-ring is in good condition.

If oil is not visible in window, add enough oil specified in the Lubrication section to bring up to this level. Check hydraulic system for leaks if oil level is low.

| | | |
|---------------------------|-----|----|
| Hydraulic oil level check | Yes | No |
| Oil added | Yes | No |

Hydraulic (Water Glycol) Level

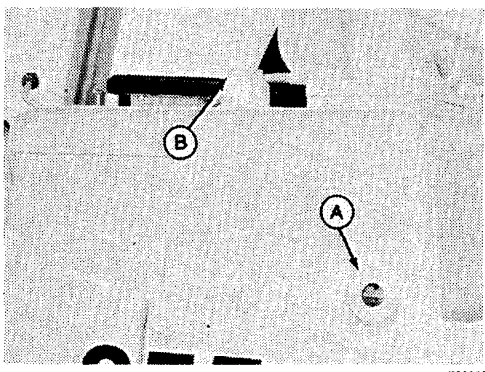

A—Oil Level Window B—Fill Plug

Fig. 15A-Hydraulic Reservoir
 (Steel Mill Loader)

Hydraulic water glycol level should be visible in oil level window.

CAUTION: The hydraulic reservoir is completely closed and pressurized. Slowly remove the fill plug to relieve the reservoir pressure. When replacing the fill plug, be sure it is screwed down tight and the O-ring is in good condition.

If water glycol is needed, add enough HOUGHTO-SAFE® 620 or an equivalent to bring up to this level. Check hydraulic system for leaks if oil level is low.

| | | |
|------------------------------------|-----|----|
| Hydraulic water glycol level check | Yes | No |
| Water glycol added | Yes | No |

14. Alternator-Fan-Compressor Belt Tension

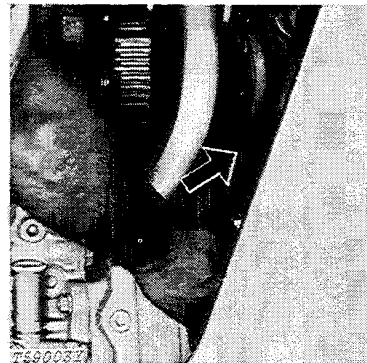

Fig. 16-Checking Belt Tension

Check alternator belt tension. If belt tension gauge is used, a force of 18 lb. (80 N) (8 kg) midway between pulleys should deflect belt 1/2-inch (13 mm).

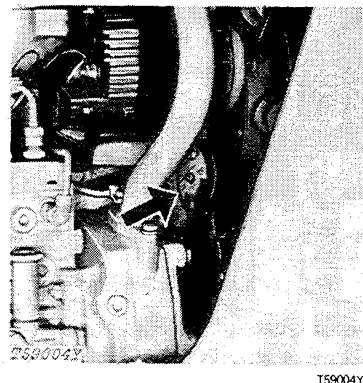

Fig. 17-Checking Strand Tension

If strand tension gauge is used, tighten used belt to 90 lb. (400 N) (41 kg) tension. Tighten new belt to 135 lb. (600 N) (61 kg).

If adjustment is required, see the After-Sale Inspection section.

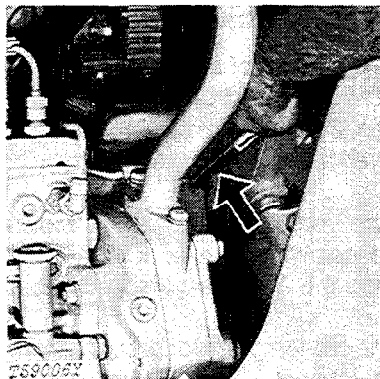

Fig. 18-Checking Belt Tension

Check fan belt tension. If belt tension gauge is used, a force of 12 lb (53 N) (5 kg) midway between pulleys should deflect belt 1/2-inch (13 mm).

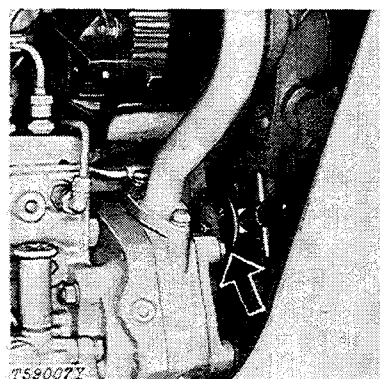

Fig. 19-Checking Strand Tension

If strand tension gauge is used, tighten used belt to 90 lb (400 N) (41 kg) tension. Tighten new belt to 100 lb (445 N) (45 kg).

If adjustment is required, see the After-Sale Inspection section.

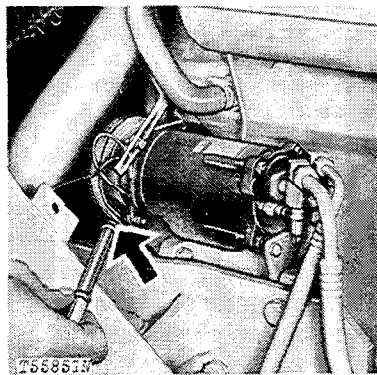

Fig. 20-Checking Belt Tension

Check compressor belt tension. If belt tension gauge is used, a force of 15 lb (67 N) (7 kg) midway between pulleys should deflect belt 1/4-inch (6 mm).

Litho in U.S.A.

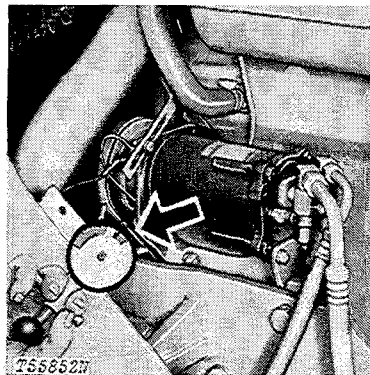

Fig. 21-Checking Strand Tension

If strand tension gauge is used, tighten used belt to 90 lb (400 N) (41 kg) tension. Tighten new belt to 135 lb (600 N) (61 kg).

If adjustment is required, see the After-Sale Inspection section.

| | |
|-------------------------|-----------------------------|
| Alternator belt tension | _____ lbs. (N) (kg) tension |
| | _____ inch (mm) flex |
| Fan belt tension | _____ lbs. (N) (kg) tension |
| | _____ inch (mm) flex |
| Compressor belt tension | _____ lbs. (N) (kg) tension |
| | _____ inch (mm) flex |

15. Engine Speeds

Warm up engine and attach a tachometer in the engine rotation tool hole to check engine speeds.

Fast idle speed should be 1960-2000 rpm. Slow idle should be 975-1000 rpm.

If engine speeds need adjustment, proceed as follows:

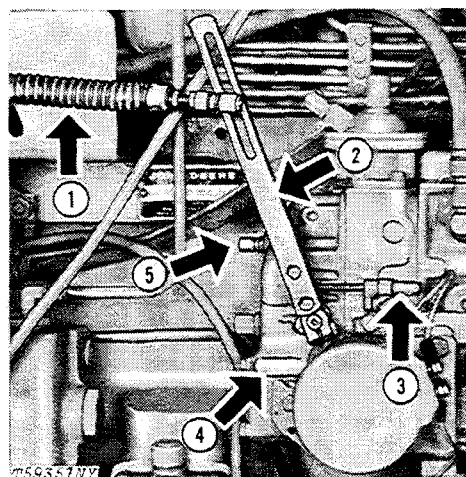

- | | |
|------------------------|-------------------|
| 1—Engine Speed Cable | 4—Injection Pump |
| 2—Lever | 5—Slow Idle Screw |
| 3—Fast Idle Stop Screw | |

Fig. 22-Engine Speed Adjustment

1 - Disengage engine cold weather disconnect clutch.

2 - Set the fast idle on the fuel injection pump to 1960-2000 rpm by turning the fast idle stop screw (3, Fig. 22). Turn counterclockwise to increase speed.

3 - Seal fast idle screw.

4 - Engage engine cold weather disconnect clutch.

5 - Adjust slow idle screw (5) for 975-1000 rpm.

6 - Adjust the speed control lever stop screws so that the speed control lever strikes them at the same time fast and slow idle is achieved at the injection pump.

IMPORTANT: Whenever either the fast or slow idle speeds are adjusted on the injection pump, the engine speed control lever to injection pump cable adjustment has to be made. Refer to Section 90 for this adjustment.

Use the following test to check engine speed control linkage and automatic control valve linkage synchronization. This test requires a 100 ft (305 m) flat area to drive the machine.

1. Run the engine at slow idle.

2. Move the FNR speed control handle forward to approximately 3/4 speed position.

3. Slowly and evenly increase engine rpm at a rate in which the machine will travel approximately 100 ft (305 m) when fast idle position is obtained.

4. Run the engine at fast idle.

5. Slowly and evenly decrease engine speed at a rate in which the machine will travel approximately 100 ft (305 m) when slow idle position is obtained.

6. The machine must not slow down or stop at any point in the rpm range. If a rpm decrease (dead spot) occurs, the engine speed control linkage and automatic control valve linkage are not synchronized. See Section 90 of this manual for adjustment.

| | | |
|-----------------------|-----|----|
| Engine speeds checked | Yes | No |
| Adjustment required | Yes | No |

16. Track Sag Adjustment

Check the amount of sag in center of track between front carrier roller and front idler. Sag should be 1 to 1-1/2 inches (25.4 to 38 mm). If adjustment is required, see the After-Sale Inspection section.

Check the vertical and horizontal movement of the front idler assembly on the track frame. If adjustment is required, see the After-Sale Inspection section.

Check the carrier rollers for proper alignment with the track. If adjustment is required, see the After-Sale Inspection section.

| | | |
|--|-----|----|
| Track tension checked | Yes | No |
| Front idler and carrier rollers wear checked | Yes | No |
| Adjustment required | Yes | No |

17. Seat Operation

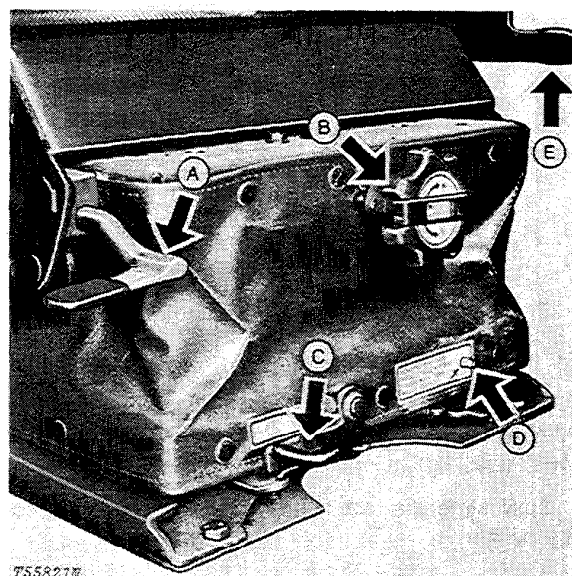

A—Height Adjustment Lever
 B—Weight Adjustment Spinner
 C—Forward/Rearward Adjustment Lever
 D—Weight Adjustment Indicator
 E—Tilt Adjustment Lever

Fig. 23-Seat Adjustments

To adjust height, push down on lever (A) to move seat to the desired position. Release lever. To adjust weight, turn knob (B) until indicator (D) is flush with tube when seated. Use flip-out handle on the knob for rapid adjustment. To adjust forward or rearward, lift up on lever (C) and slide seat to the desired position. Release lever. To adjust tilt, lift up on lever (E) to tilt seat backward or push down to tilt seat forward. Release lever.

| | | |
|------------------|-----|----|
| Seat operational | Yes | No |
|------------------|-----|----|

18. Indicator Lights and Gauges

When operating the crawler, check the following gauges for correct operation.

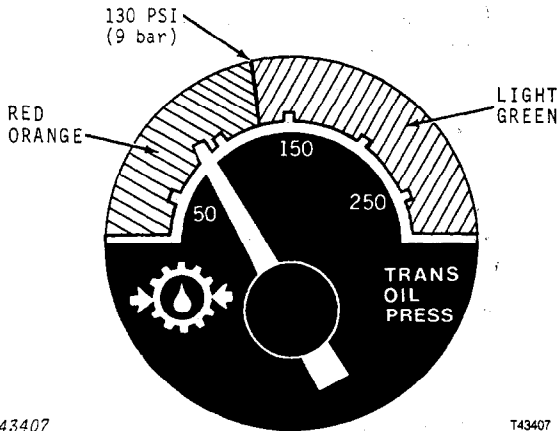

T43407 Fig. 24-Transmission Oil Pressure Gauge

Normal operating range is in the light green zone.

Check transmission oil pressure gauge during operation. If transmission oil pressure is not in the light green zone, shut off engine. Check transmission oil level. If oil is at proper level, troubleshoot the transmission system, checking for bent or broken lines and hoses. Also check for excessive leakage.

Transmission oil pressure may register slightly above the green zone in neutral or at full engine speed.

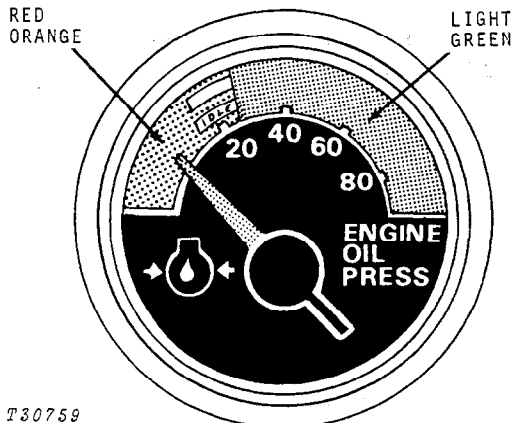

T30759 Fig. 25-Engine Oil Pressure Gauge

If the indicator hand of the engine oil pressure gauge drops into the red-orange zone, stop the crawler and check engine oil level. If oil level is not low, check for restrictions in oil lines or incorrect viscosity oil.

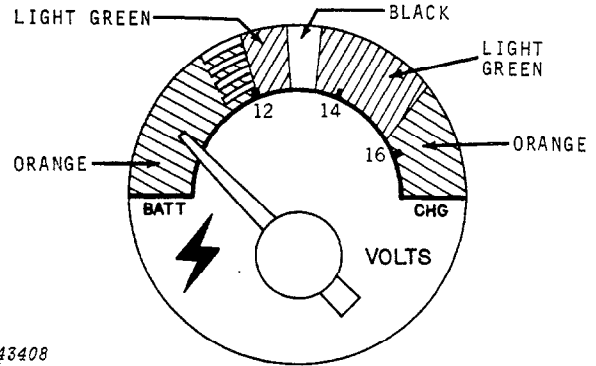

T43408

Fig. 26-Voltmeter

T43408

With key switch on and engine off, the indicator should be in the lower left light green zone.

When cranking the engine, the indicator will fall into the left-hand orange zone. When the engine starts, the indicator should move to stay in the right-hand light green zone.

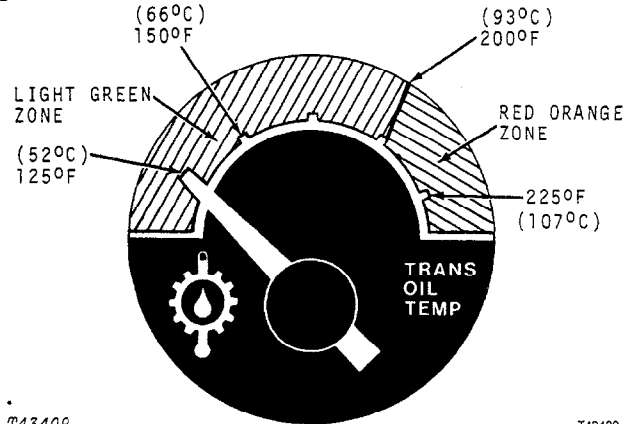

T43409

Fig. 27-Transmission Oil Temperature Gauge

T43409

Do not permit this temperature to exceed 200°F (93°C). If the temperature reaches this point during operation, stop the engine and locate the trouble.

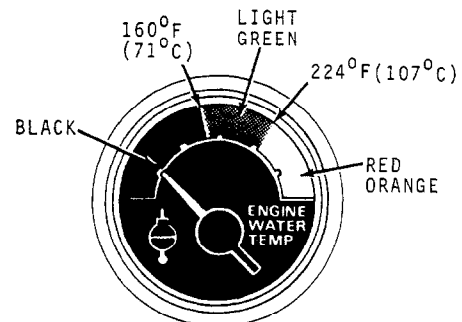

T38572

Fig. 28-Engine Water Temperature Gauge

T38572

Normal operating temperature is in the light green zone.

If the indicator hand goes into the red-orange zone, check cooling system.



T23111N

T23111N

Fig. 29-Transmission Oil Filter Indicator Light

NOTE: Light should glow, if operative, with key switch in start position and engine off.

When the engine is running, the transmission oil filter indicator light should go out, indicating that there is no restriction in the transmission and oil filters. If light glows red while the engine is running, stop engine and determine cause.

The transmission oil filter indicator light glows red also if the pressure switch located with the engine oil pressure sending unit is faulty, if the engine oil pressure is low, or if the oil is cold during initial startup.



T38471N

T38471N

Fig. 30-Hydraulic Filter Restriction Indicator Light

NOTE: Light should glow, if operative, with key switch in start position and engine off.

When the engine is running, the hydraulic oil filter indicator light should go out. If light glows red while the engine is running, stop engine and determine cause. Light may glow during initial operation until oil warms.

If crawler loader is equipped with a cab, check the operation of the air conditioner.

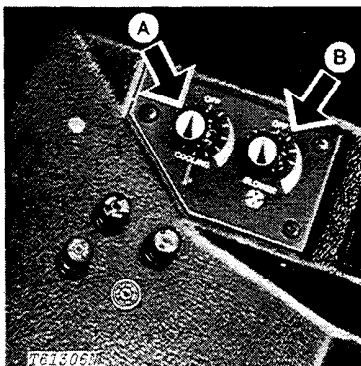

T61306N

A—Cooling Control Knob

B—Blower Control Knob

Fig. 31-Air Conditioner Controls

Litho in U.S.A.

With key switch "on", operate blower knob in all positions. Observe fan speeds and air volume from air ducts.

With key and blower switches "on", turn cooling control knob toward maximum cooling and listen for audible "click" from compressor clutch.

Heater control knob must be in the "off" position (heater valve closed).

With blower switch at "high speed" and cooling control knob at maximum cooling, operate engine at 1900 rpm.

After 10 minutes, observe sight glass located on the front of the receiver-dryer for bubbles.

NOTE: Bubbles may be present immediately after compressor cycles "on". If occasional bubbles or a constant stream of bubbles are observed under any other condition, refer to Group 9031 of this manual.

Check temperature of discharge air from air ducts. Hold thermometer in air duct until lowest reading is obtained.

- If ambient temperature is above 80°F (27°C), the duct air temperature must be 25 to 30°F (14 to 17°C) below ambient temperature.
- If ambient temperature is below 80°F (27°C), the duct air temperature must be less than 50°F (10°C).

If unit does not operate as described above, refer to Group 9031 of this manual.

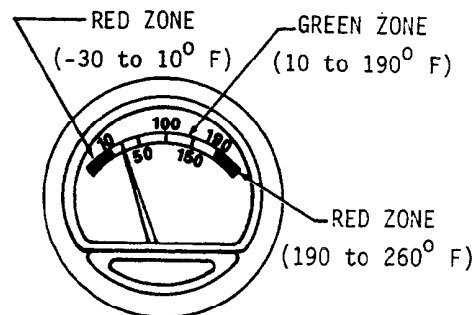

T93246

Fig. 32-Audio Visual Temperature Warning Device
(Steel Mill - Water Glycol Only)

Immediately after starting, the gauge will read in the red zone and the buzzer will sound. After warm-up, normal operation will show green and the buzzer will stop.

Do not move loader control lever until gauge is green and buzzer has stopped.

| | | |
|-----------------------------------|-----|----|
| Gauges operational | Yes | No |
| Air conditioner operation checked | Yes | No |

19. Light Operation

All lights are controlled by the "push-pull" light switch. To turn on lights, pull out switch knob. To turn off lights, push in switch knob. The key switch must be in the "on" position before the lights will operate.

Lights operational Yes No

20. Transmission Control



Fig. 33-Transmission Shifting

T66651Y

Move the forward and reverse speed control lever forward from "neutral" to provide control of forward ground speeds from zero to maximum.

Move the lever rearward to control reverse ground speeds from zero to maximum. The forward and reverse speed control lever has a Z pattern movement to provide a positive location of the "neutral" position.

The forward and reverse speed control lever in "neutral" gives a braking effect. Engine braking is available as the control lever passes from forward or reverse speeds to neutral.

When the brake pedal is depressed, the forward and reverse speed control lever returns to the neutral position.

Transmission operational Yes No

21. Hydraulic Brake (Park Brake)

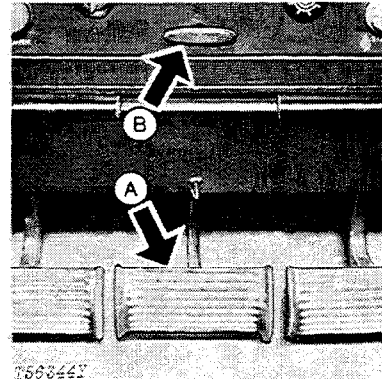

A—Park Brake Pedal

B—Park Brake Lock Knob

Fig. 34-Park Brake

When the brake pedal is depressed, the forward and reverse speed control lever returns to neutral automatically.

Operate the forward and reverse speed control lever to verify braking in neutral.

Brakes operational Yes No

22. Steering

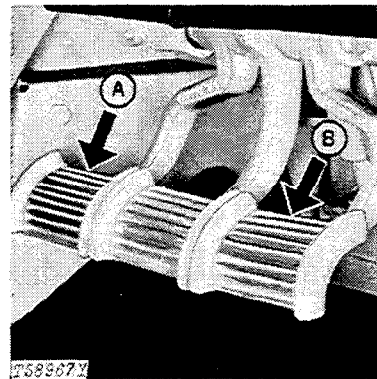

A—Left Steering Pedal

B—Right Steering Pedal

Fig. 35-Steering Pedals

Depress steering pedal (right pedal for right turn etc.) beyond the neutral position. This allows the tracks to travel in opposite directions. DO NOT attempt to depress both pedals into this rearward position to reverse direction.

Steering operational Yes No

23. Lubrication

The crawler loader was checked and lubricated before it left the factory. However, to insure customer satisfaction, check each lubrication point shown in the following pages. If necessary, lubricate with grease specified in the Lubrication section.

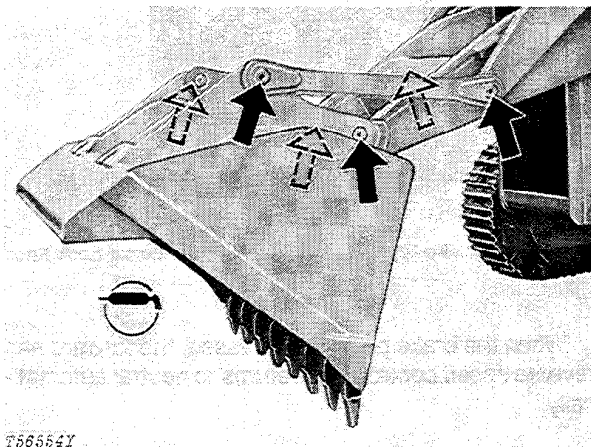

T56554Y

T56554Y

Fig. 36-Bucket Linkage Pivots (6 Points)

Lubricant required Yes No

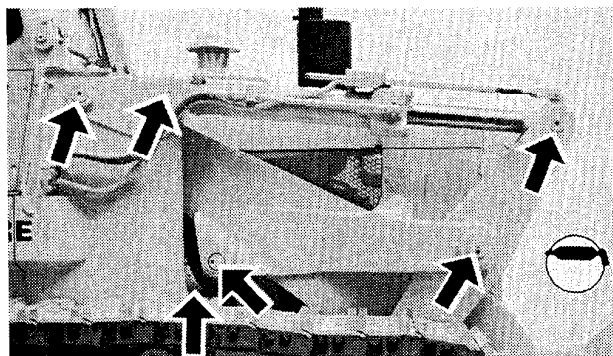

T56554Y

Fig. 37-Loader Linkage Pivots (12 Points)

Lubricant required Yes No

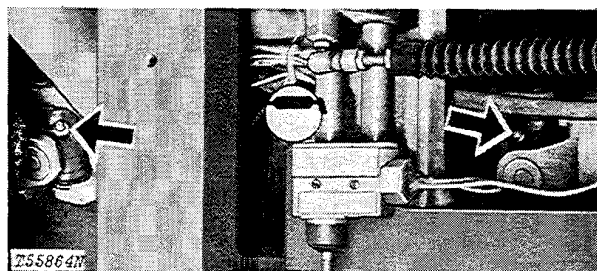

T55864Y

T55864Y

Fig. 38-Universal Joints (4 Points)

Lubricant required Yes No

24. Neutral Lock Lever Operation

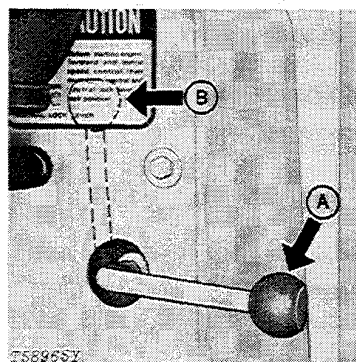

T58965Y

T58965Y

A—Run Position

B—Lock Position

Fig. 39-Neutral Lock Lever

Before starting engine, move forward and reverse speed control lever to neutral position and neutral lock lever to lock (B) position. Transmission is locked in neutral position. Starter operates only when neutral lock lever is in locked position.

After engine is running, move neutral lock lever to run position (A). Shift to desired position.

Neutral lock lever operational Yes No

25. Injection Pump

IMPORTANT: Serious engine damage will occur when the engine is operated above 7,500 ft. (2 286 m), unless the adjustment for fuel delivery on the fuel injection pump is changed. The warranty on the engine will also be voided.

Before the crawler is used at elevations above 7,500 ft. (2 286 m), remove the injection pump and take the pump to a Robert Bosch authorized service station for fuel injection pumps. See Group 0413 for injection pump removal.

Reduce fuel delivery by 3% for every 1,000 ft. (305 m) the crawler will operate above 7,500 ft. (2 286 m). This adjustment is for rated speed and peak torque ONLY.

See Group 0499 for fuel specifications. See also TM-1071, Section 30, Group 15, "Adjusting Fuel Delivery".

IMPORTANT: Be sure to stamp the date on this adjustment and the elevation on the injection pump tag.

Injection pump adjusted Yes No
 Date of adjustment _____
 Elevation _____ft (m)

26. Accessible Hardware Torque Values

Check all accessible cap screws and nuts for proper tightness. If hardware seems loose, tighten it to the proper torque. The tables in Group III give correct torque values for various bolts and cap screws. The tables list torques in the U.S. unit of measure (lb-ft) and SI metrics (N·m). Most hardware used is high-strength (note dashes on hex. heads).

The types of bolts and cap screws are identified by head markings as follows:

Plain Head: regular machine bolts and cap screws.

3-Dash Head: tempered steel high-strength bolts and cap screws.

6-Dash Head: tempered steel extra high-strength bolts and cap screws.

Machine bolts and cap screws 7/8-inch and larger are sometimes formed hot rather than cold, which accounts for the lower torque.

All accessible hardware torqued

Yes No

27. Radiator Air Flow Pre-Test Inspection

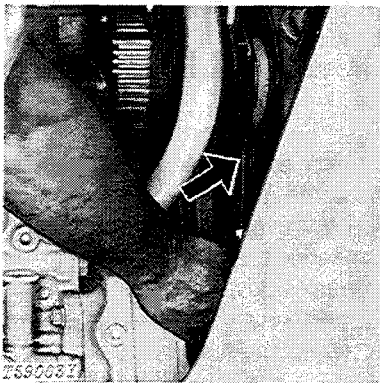

Fig. 40-Checking Belt Tension

T59003

CAUTION: DO NOT remove radiator cap until radiator top tank feels cool.

1. Check coolant level.

2. Check for belt tension. A force of 53 N (12 lb force) on belt halfway between pulleys must move belt 13 mm (0.50 in.). Adjust belt if necessary.

3. Check radiator fin condition. Make sure fins are not bent or damaged.

4. Check fan blade tips, shroud, and baffle, for damage. Fan blade tip to shroud distance must be equal at top and bottom.

5. Check for blower fan installation (sucker fan optional).

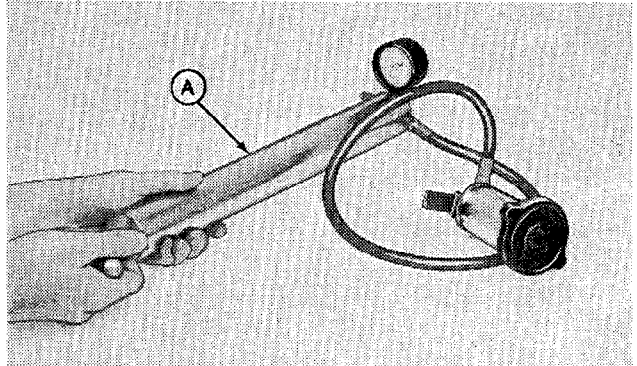

T82483

Fig. 40A-Testing Radiator Cap

6. Connect radiator cap to a D-05104ST Pressure Pump (A). Raise pressure until cap valve opens. Valve must hold pressure at 43 to 50 kPa (0.43 to 0.51 bar) (6.25 to 7.50 psi) for one minute. If pressure decreases, install a new cap.

28. Radiator/Oil Cooler Air Flow Test

1. Apply parking brake, put transmission in neutral, apply neutral lock lever, and start engine. Raise loader and install boom lock bar. Stop engine.

2. Remove side shields and grille screen.

3. Divide the surface of radiator into 16 equal squares with white chalk lines on the front of the radiator.

4. Install a D-01084AA Tachometer/Temperature Reader on the machine. Start engine and check slow idle. Slow idle must be 975-1000 rpm.

5. Run engine at 1075 rpm.

6. Connect JT05529 Air Flow Meter to D-27501BM Digital-Multimeter or JT27504 Heavy Duty Digital Multimeter. Turn switch on multimeter to 20 volts AC.

IMPORTANT: Unit is equipped with a blower fan (sucker fan is optional.).

Direction arrow on Air Flow meter must be away from radiator for blower fan and towards radiator for sucker fan.

7. Hold Air Flow Meter in direct contact with radiator with direction arrow toward radiator. Hold multimeter with other hand and stand to side of unit to prevent interference with air flow. Make a record of the multimeter reading for each square.

8. Compare readings to Pre-Delivery Inspection records or repeat entire procedure on a new unit, with the same equipment for comparison. If readings are reduced by 20% or more, remove oil cooler. Clean external surfaces of both oil cooler and radiator. Install oil cooler.

Air Flow Test Readings

Record sum of individual values for future reference:

| | | | |
|--|--|--|--|
| | | | |
| | | | |
| | | | |
| | | | |

194610

29. Final Check

The final predelivery procedure is the overall cleanup of the crawler. Make the crawler LOOK like a new crawler with the proper touch-up of chipped paint and a good wash job. Deliver to the customer a crawler anyone would be proud to own.

DELIVERY SERVICE

A thorough discussion of the operation and service of this new crawler at the time of delivery helps to assure complete customer satisfaction. Proper delivery should be an important phase of the dealer's program. A portion of the John Deere Delivery Receipt emphasizes the importance of proper delivery service.

Many complaints arise because the owner was not shown how to operate and service the new crawler properly. Devote enough time at the customer's convenience, to introduce the owner to the new crawler. Explain how to operate and service it.

The following procedure is recommended before the service technician and owner complete the delivery acknowledgments portion of the Delivery Receipt.

Using the operator's manual as a guide, be sure that the owner understands these points thoroughly:

1. The importance of safety.
2. The importance of lubrication and periodic services.
3. The importance of the break-in period.
4. Controls and instruments.
5. How to start and stop the engine.
6. All functions of the hydraulic system.

After explaining and demonstrating the above features, have the owner sign the Delivery Receipt and give the owner the operator's manual.

AFTER-SALE INSPECTION

The purchaser of a new John Deere crawler is entitled to a free inspection at some mutually agreeable time within the warranty period after the equipment has been "run-in," usually after 50 to 100 hours of crawler operation. The terms of this after-sale inspection are outlined on the customer's John Deere Delivery Receipt.

The inspection is to make sure that the customer is receiving satisfactory performance from the crawler. At the same time, the inspection should reveal whether or not the crawler is being operated, lubricated, and serviced properly.

If the recommended after-sale service inspection is followed, the dealer can eliminate a needless volume of service work by preventing minor irregularities from developing into serious problems later on. This will promote strong dealer-customer relations and present the dealer an opportunity to answer questions that may have arisen during the first few days of operation.

During this inspection service, the dealer has the opportunity to promote the possible sale of other new equipment.

Check operation of all controls and instruments for freedom of movement and correct operation.

1. Engine Crankcase Oil and Filter Elements

NOTE: Check with the customer if oil has been changed and filter replaced before performing this service.

Normal sequence of service is as follows:

- Change Oil and Filters - after first 100 hours
- every 200 hours thereafter

If changed, record information below:

Approximate hours at change

If not, change as follows:

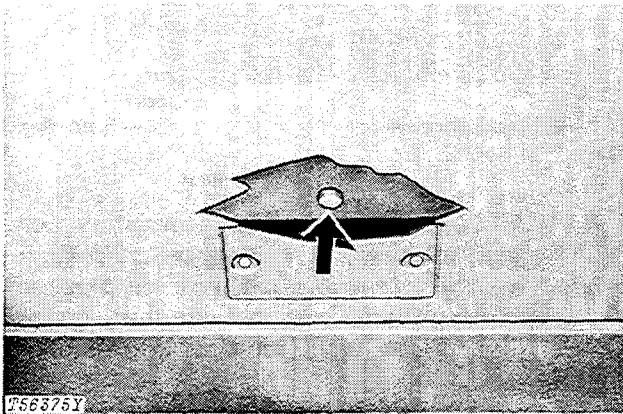

Fig. 41-Engine Crankcase Drain Plug

- 1 - Run engine to heat oil.
- 2 - Drain oil from engine crankcase.
- 3 - While crankcase is draining, replace filter elements as follows:

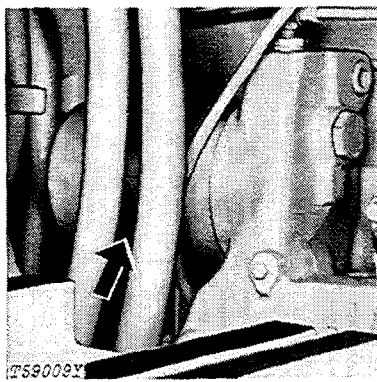
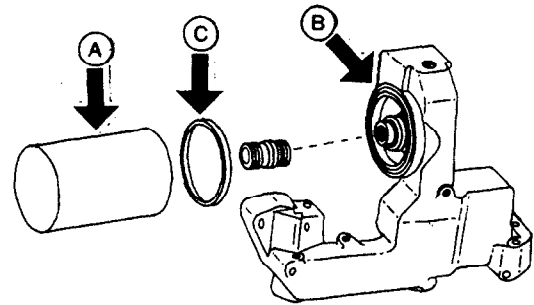

Fig. 42-Engine Crankcase Filter Element



A—Oil Filter Element
B—Mounting Surface

C—Sealing Ring

T57994N

Fig. 43-Crankcase Oil Filter Component

- A - Remove filter element. (Turn counterclockwise.)
- B - Clean mounting surface.
- C - Apply film of oil to sealing ring.
- D - Tighten element until sealing ring touches mounting surface.
- E - Turn an additional 1/2 to 3/4 turn.
- F - Do not overtighten.

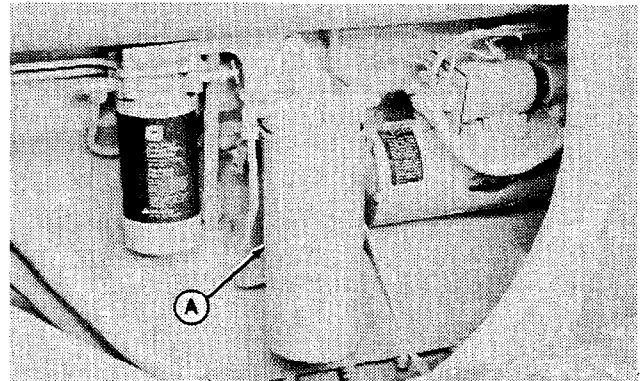

Fig. 44-Engine Oil Bypass Filter

NOTE: Change engine bypass oil filter at the same time the engine oil filter and engine oil are changed.

- A - Remove bypass oil filter (A). (Turn filter counterclockwise.)
- B - Clean mounting surface.
- C - Apply a film of oil to the packing.
- D - Tighten new filter until sealing ring touches mounting surface.
- E - Turn the filter by hand 1 turn more.
- F - Do not overtighten.

- 4 - Install drain plug.
- 5 - Fill crankcase with new oil of proper viscosity. Capacity is 36.5 quarts (34.5 L) with filters.
- 6 - Run engine a short time and check for leaks at filter base and drain plug.
- 7 - Stop engine.
- 8 - Check oil level. Level should be between marks on dipstick.

| | | |
|----------------------------|--------------|----|
| Crankcase oil changed | Yes | No |
| Oil filter element changed | Yes | No |
| Oil bypass filter changed | Yes | No |
| Oil added, if any | ____qts. (L) | |

2. Hydrostatic Transmission Oil Level

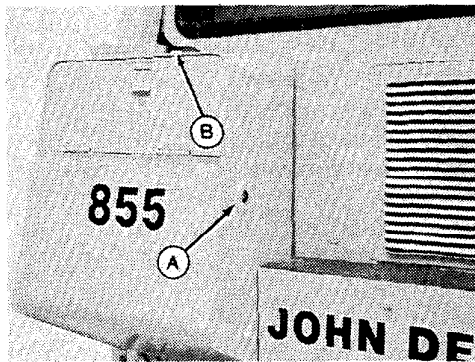

A—Oil Level Window
 B—Filler Plug

Fig. 44-Check and Fill Areas

Park crawler on a level surface and stop the engine.

Transmission oil level should be halfway up in oil level window.

CAUTION: The hydrostatic transmission system is a sealed design and has no vent. Remove filler plug slowly to release pressure. When replacing the filler plug, be sure it is screwed down tight and the O-ring is in good condition.

If oil is not visible in window, add oil specified in the Lubrication section to bring up to this level. Check transmission system for leaks if oil level is low.

| | | |
|--------------------------------|-----|----|
| Transmission oil level checked | Yes | No |
| Oil added | Yes | No |

3. Hydraulic (Oil) Level

Park crawler on a level surface with bucket on ground and ripper (if equipped) in transport position. Stop the engine.

Check oil in hydraulic system. Oil level should be half-way up in oil level window.

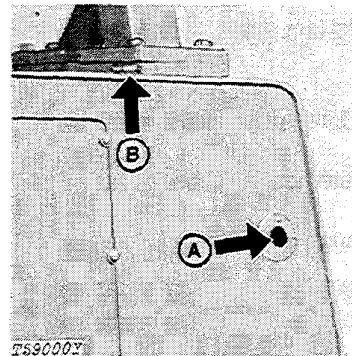

A—Oil Level Window
 B—Filler Plug

Fig. 45-Check and Fill Areas

CAUTION: The hydraulic reservoir is completely closed and pressurized. Slowly remove the fill plug to relieve the reservoir pressure. When replacing the fill plug, be sure it is screwed down tight and the O-ring is in good condition.

If oil level is low, remove fill plug located on top of the oil reservoir. Add oil specified in the Lubrication section until oil level reaches midpoint on the oil level window. Check hydraulic system for any leaks if oil level is low.

| | | |
|-----------------------------|--------------|----|
| Hydraulic oil level checked | Yes | No |
| Oil added, if any | ____qts. (L) | |

Hydraulic (Water Glycol) Level

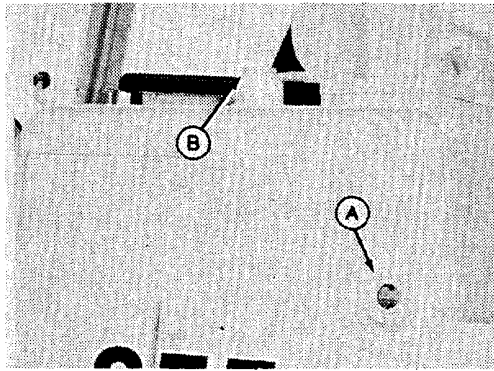

A—Oil Level Window

B—Fill Plug

Fig. 45A—Check and Fill Areas

Hydraulic water glycol level should be visible in oil level window.

CAUTION: The hydraulic reservoir is completely closed and pressurized. Slowly remove the fill plug to relieve the reservoir pressure. When replacing the fill plug, be sure it is screwed down tight and the O-ring is in good condition.

If water glycol is needed, add enough HOUGHTON-SAFE® 620 or an equivalent to bring up to this level. Check hydraulic system for any leaks if oil level is low.

| | | |
|--------------------------------------|-----|----|
| Hydraulic water glycol level checked | Yes | No |
| Water glycol added | Yes | No |

4. Splitter Gearbox Oil Level

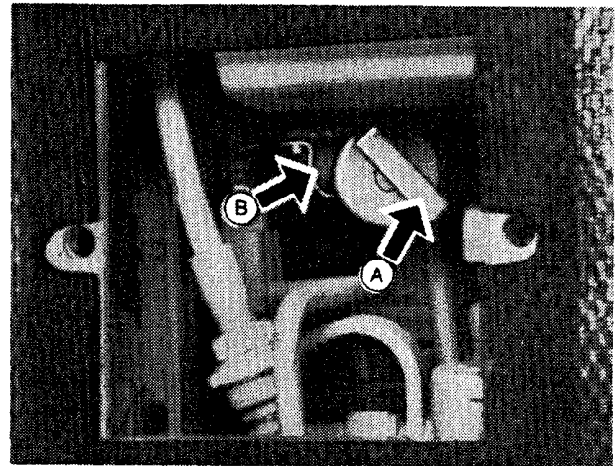

A—Dipstick

B—Filler Tube

Fig. 46—Splitter Gearbox

Filler tube and dipstick are located on the rear of the splitter housing under the floorboard plate.

IMPORTANT: DO NOT overfill. Overfilling may cause overheating.

Park crawler on a level surface and stop the engine.

Remove dipstick. Oil level should be between marks on the dipstick. If oil level is low, fill with oil or equivalent and replace dipstick. Do not overtighten dipstick.

| | | |
|------------------------------------|-----------|----|
| Splitter gearbox oil level checked | Yes | No |
| Oil added, if any | —qts. (L) | |

5. Inner and Outer Final Drive Housing Oil Level

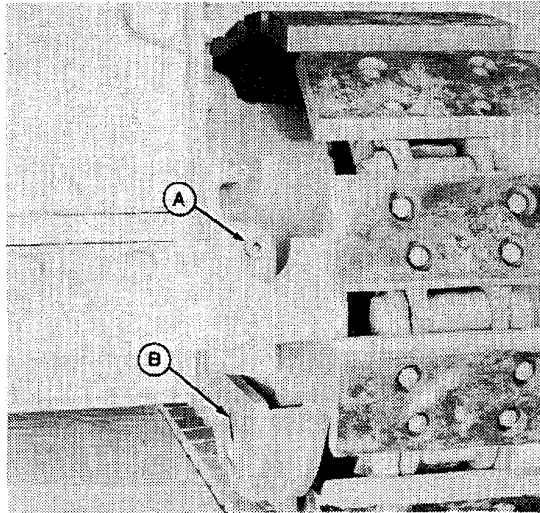

A—Level-Filler Plug B—Drain Plug

Fig. 47-Inner Final Drive Housing

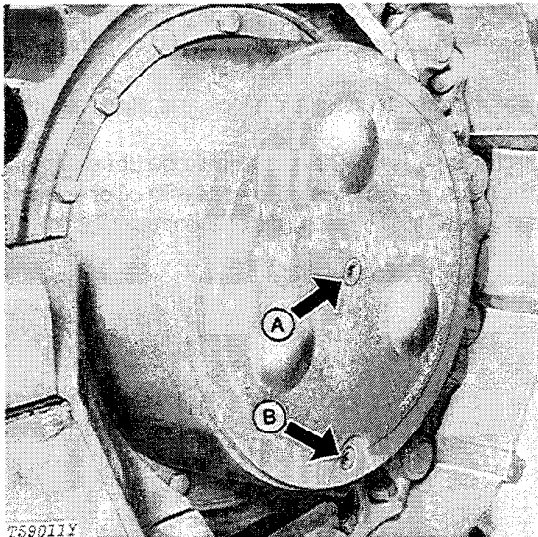

A—Level-Filler Plug B—Drain Plug

Fig. 48-Outer Final Drive Housing

Check the oil levels of the inner and outer final drive housings. Oil level should be at a level-filler plug. If low, add enough oil specified in the Lubrication section to bring oil level to check and fill plug.

| | | |
|---|-----------|----|
| Inner and outer final drive housing oil level checked | Yes | No |
| Oil added, if any | —qts. (L) | |

6. Air Cleaner

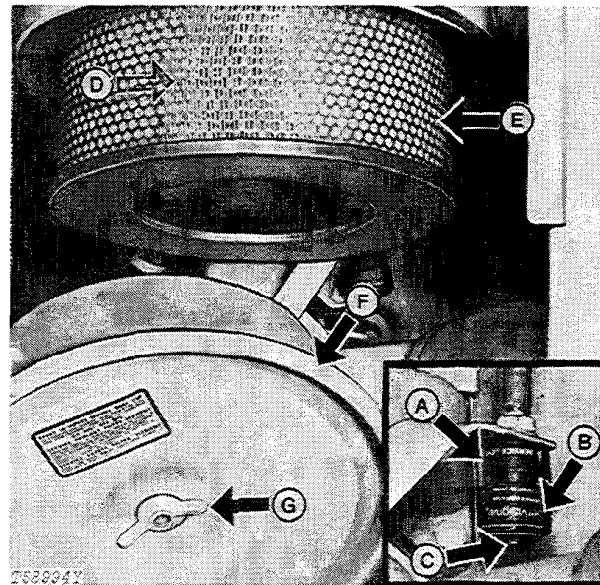

A—Red Signal E—Primary Element
 B—Restriction Indicator F—Cover
 C—Reset Button G—Wing Nut
 D—Safety Element

Fig. 49-Air Cleaner

Check air cleaner restriction indicator. If red signal locks in full view, remove and clean primary element. Replace element if necessary.

NOTE: If cleaning primary element does not return restriction indicator to normal, replace the safety element.

| | | |
|--|-----|----|
| Air cleaner elements checked | Yes | No |
| Air cleaner elements cleaned or replaced | Yes | No |

7. Air Intake Hose

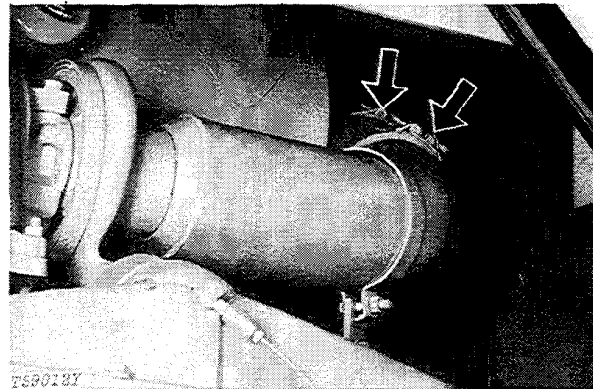

Fig. 50-Air Intake Hose Connections

Check clamps on hose which connects air cleaner and engine. Tighten hose clamps where necessary to prevent dirt from entering engine. Inspect hose for cracks and wear. Check air intake system for leaks.

Loose connections Yes No

8. Alternator-Fan-Compressor Belt Tension

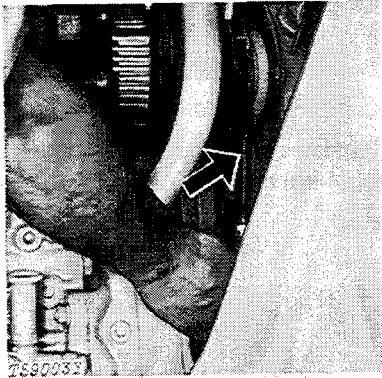

Fig. 51-Checking Belt Tension

Check alternator belt tension. If belt tension gauge is used, a force of 18 lb. (80 N) (8 kg) midway between pulleys should deflect belt 1/2-inch (13 mm).

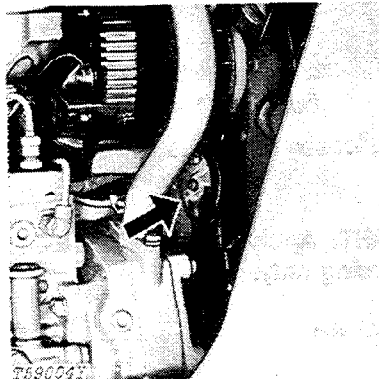

Fig. 52-Checking Strand Tension

If belt gauge is used, tighten used belt to 90 lb. (400 N) (41 kg) strand tension. Tighten new belt to 135 lb. (600 N) (61 kg).

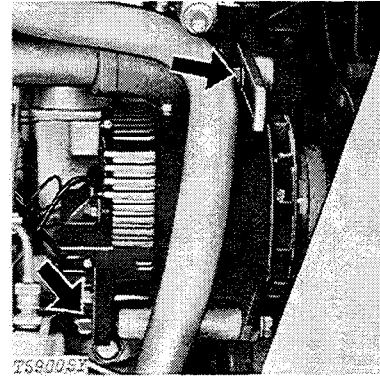

Fig. 53-Adjusting Screws

To adjust, loosen alternator bracket and adjusting screws.

IMPORTANT: Apply outward force to front of alternator housing only.

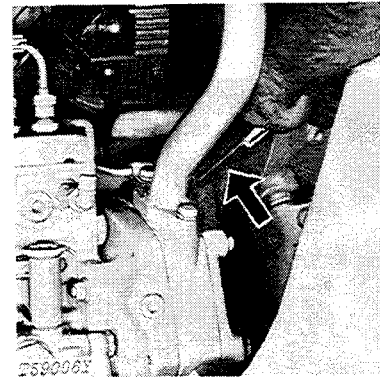

Fig. 54-Checking Belt Tension

Check fan belt tension. If belt tension gauge is used, a force of 12 lb. (53 N) (5 kg) midway between pulleys should deflect belt 1/2-inch (13 mm).

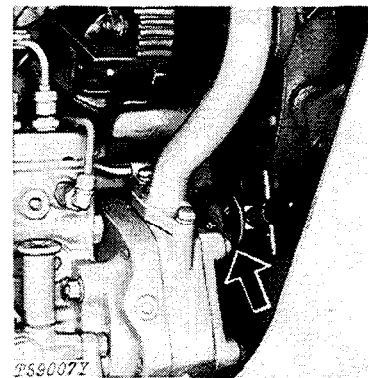

Fig. 55-Checking Strand Tension

If strand tension gauge is used, tighten used belt to 90 lb. (400 N) (41 kg) tension. Tighten new belt to 100 lb. (445 N) (45 kg).

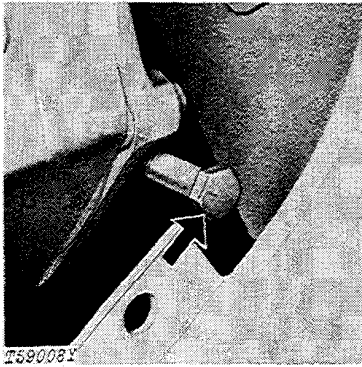

Fig. 56-Adjusting Screw

To adjust, loosen the 3 cap screws holding the idler pulley support onto the idler pulley bracket. Loosen lock nut on cap screw and turn cap screw on the side of the idler pulley clockwise. This will apply outward pressure on the idler pulley. Tighten lock nut on cap screw. Tighten the 3 cap screws holding the idler pulley support onto the idler pulley bracket.

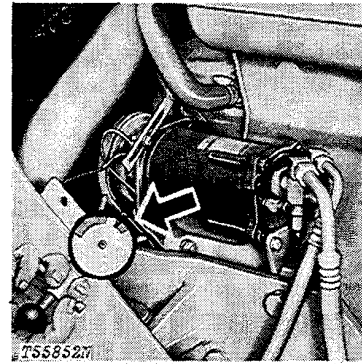

Fig. 58-Checking Strand Tension

If strand tension gauge is used, tighten used belt to 90 lb. (400 N) (41 kg) tension. Tighten new belt to 135 lb. (600 N) (61 kg).

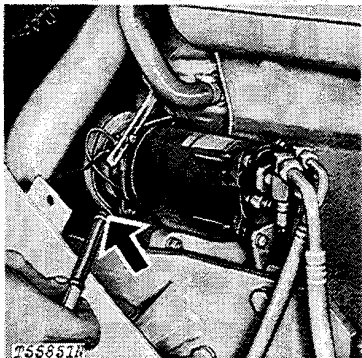

Fig. 57-Checking Belt Tension

Check compressor belt tension. If belt tension gauge is used, a force of 15 lb. (67 N) (7 kg) midway between pulleys should deflect belt 1/4-inch (6 mm).

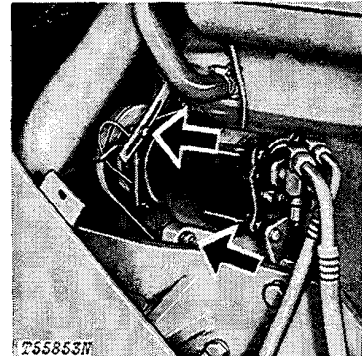

Fig. 59-Adjusting Screws

To adjust, loosen compressor bracket and adjusting screws.

IMPORTANT: Apply outward force to front of compressor housing only.

- | | |
|-------------------------|-----------------------------|
| Alternator belt tension | _____ lbs. (N) (kg) tension |
| | _____ inch (mm) flex |
| Fan belt tension | _____ lbs. (N) (kg) tension |
| | _____ inch (mm) flex |
| Compressor belt tension | _____ lbs. (N) (kg) tension |
| | _____ inch (mm) flex |

9. Engine Coolant Conditioner-Filter

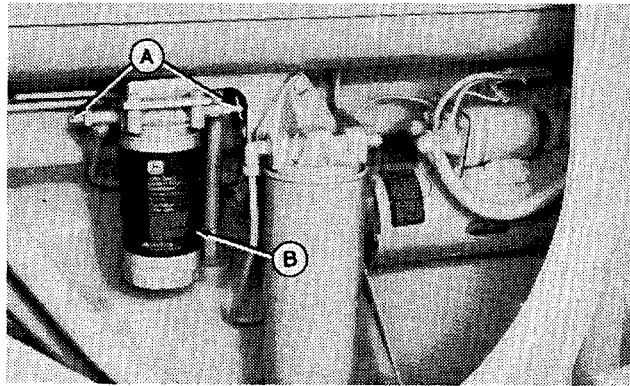

T88987

A—Shut-off Valves B—Engine Coolant Conditioner-Filter

Fig. 60-Engine Coolant Conditioner-Filter

To change conditioner-filter:

- 1 - Close shut-off valves.

CAUTION: Do not loosen conditioner-filter when engine is hot.

- 2 - Remove conditioner-filter (turn counterclockwise).
- 3 - Clean mounting surface.
- 4 - Apply film of oil to gasket of new conditioner-filter.
- 5 - Tighten new conditioner-filter until gasket touches mounting surface.
- 6 - Tighten an additional 1/2 to 3/4 turns and open valves.
- 7 - Start engine and check for leaks.
- 8 - Stop engine and check coolant level.

Coolant conditioner replaced Yes No

10. Radiator Coolant Level

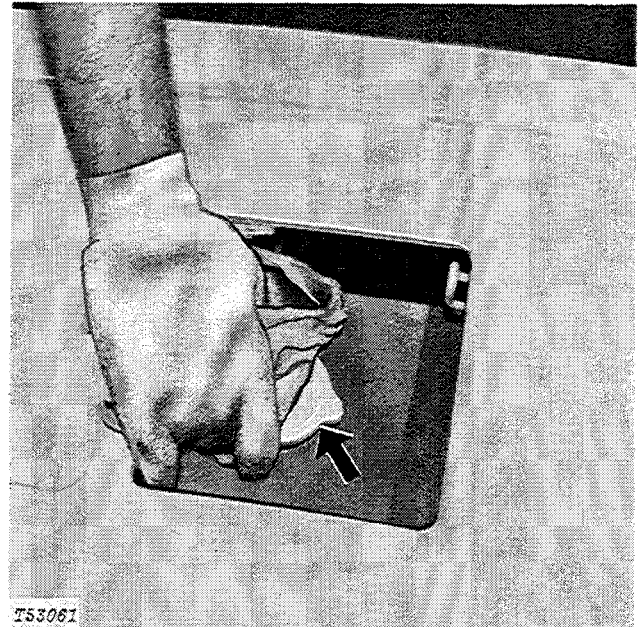

T53061

T53061

Fig. 61-Radiator Filler Cap

CAUTION: Remove radiator filler cap only when coolant temperature is below the boiling point. Then loosen the cap slightly to the stop to relieve pressure before removing the cap completely.

Check coolant level in the radiator. Coolant level should be at the bottom of the filler neck, when engine is cold. If coolant level is low, check cooling system for leaks.

| | | |
|--------------------------------------|-----------|----|
| Radiator coolant level checked | Yes | No |
| Coolant or anti-freeze added, if any | —qts. (L) | |

11. Fuel Tank Sump

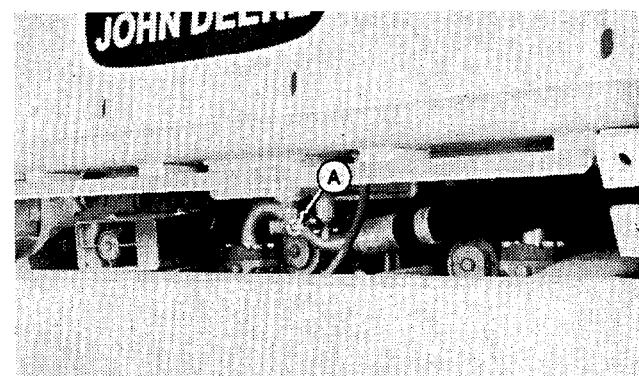

T88977

Fig. 62-Drain Cock

NOTE: Drain sump after crawler has been stopped for at least 2 hours.

To drain sump:

- 1 - Loosen cap screws on access cover and pivot cover down.
- 2 - Open drain cock (A).
- 3 - Drain fuel until it is clear of water, dirt, etc.
- 4 - Close drain cock.
- 5 - Replace access cover and tighten cap screws.

| | | |
|------------------------|-----|----|
| Fuel tank sump checked | Yes | No |
| Fuel tank sump drained | Yes | No |

12. Track Sag Adjustment

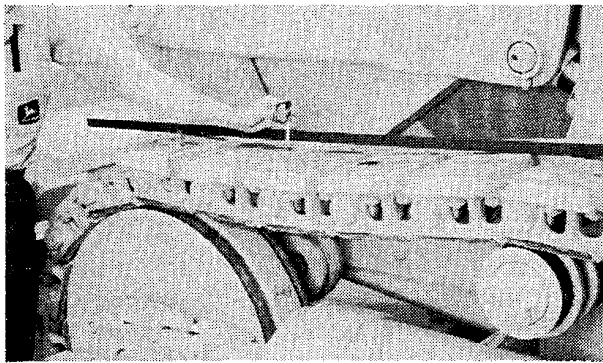
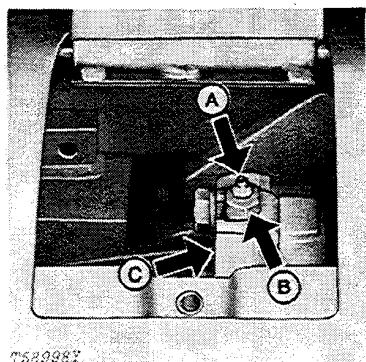

Fig. 63-Measuring Track Sag

Measure amount of sag in center of track between carrier roller and front idler. Sag should be 1 to 1-1/2 in. (25.4 to 38 mm) for sealed chain and 1-1/2 to 2 in. (38 to 50.8 mm) for lubricated chain.

NOTE: A pin and bushing must be lined up over the carrier roller.

NOTE: When changing from one ground condition to another, check the track sag after a short time of operation.



A—Grease Fitting
 B—Check Valve
 C—Vent Hole

Fig. 64-Adjusting Track Sag

Litho in U.S.A.

Loosen screw and open access cover.

To increase track tension:

- 1 - Attach a grease gun (8000 psi [552 bar] [562 kg/cm²] max.) to the grease fitting (A) on the track adjuster.
- 2 - Apply grease until the proper track tension is achieved.

To decrease track tension:

- 1 - Turn check valve (B) 1 to 3 turns counterclockwise. This will allow grease to escape through the vent hole (C).
- 2 - Turn check valve clockwise to close valve.

CAUTION: High pressure may be present in the track adjuster cylinder. If grease does not immediately escape from the vent hole, drive the unit forward and backward slowly, then tighten check valve.

IMPORTANT: Never lubricate fitting on hydraulic track adjusting cylinder except when track is in need of adjustment.

NOTE: When operating in extreme soil packing conditions, check track tension more frequently.

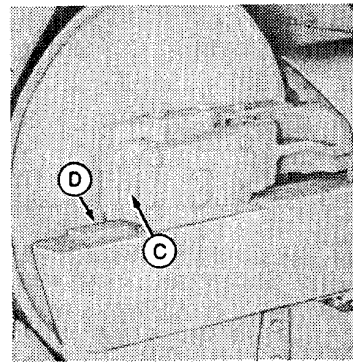

T94112

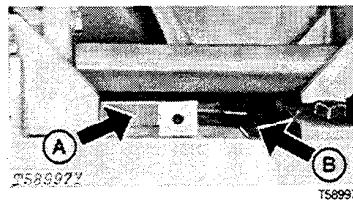

Figs. 65A and 65B-Check Track Wear

IMPORTANT: When the forward edge of the front idler block (C) is approximately in line with the front edge of the top wear strip (D), the track adjuster stop (A) will contact the track frame (B) and no further increase in track tension can be obtained. To avoid damage, recondition track.

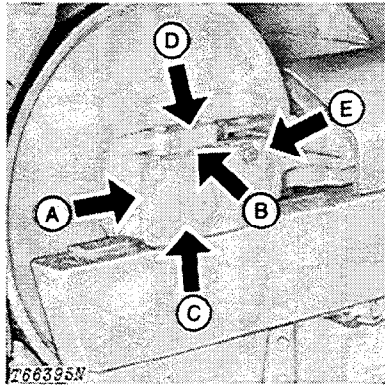

A—Horizontal Adjusting Shims
 B—Vertical Adjusting Shims
 C—Outer Guide
 D—Inner Guide
 E—Block

Fig. 66-Track Wear Adjustment Components

Inner Guide Adjustment (Vertical)

Loosen cap screws on both the inner and outer guides. Pry up on the inner guide (3 or 4, Fig. 67) and measure the gap between the block (E, Fig. 66) and the inner guide (D). Add shims (B) to obtain 0.00 to 0.04 in. (0.0 to 1.0 mm) gap.

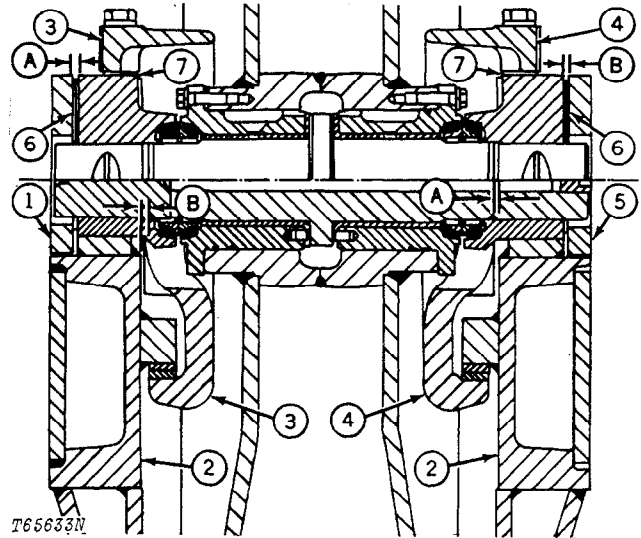

1—Right Outer Guide
 2—Track Frame
 3—Right Inner Guide
 4—Left Inner Guide
 5—Left Outer Guide
 6—Shim
 7—Shim

Fig. 67-Front Idler Guide Shims

Outer Guide Adjustment (Horizontal)

Center the idler between track frame (2, Fig. 67) so dimensions A & B are equal. Remove the outer guides (4 and 5) if required. Adjust the right outer guide (1) with shims (6) so the two dimensions A are equal. Adjust the left outer guide (5) with shims (7) so the two dimensions B are equal.

Tighten the idler guide cap screws to 170 lb-ft (230 N·m) (24 kg·m).

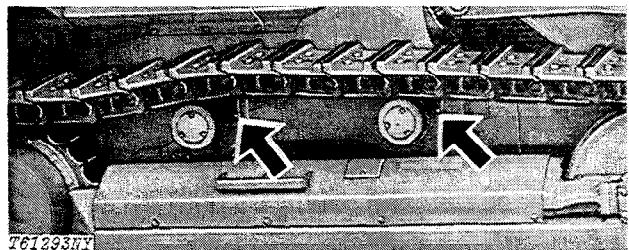

Fig. 68-Movable Carrier Roller Supports

The carrier roller supports are movable to compensate for uneven track wear. To adjust, loosen the four cap screws and the support and add or delete shims (in pairs), as required, until center of track is over center of the carrier rollers. Tighten cap screws to roller support.

IMPORTANT: Do not adjust the carrier roller front support until all of the track tension and shim adjustments have been completed.

| | | |
|---|-----|----|
| Track tension checked | Yes | No |
| Front idler and carrier roller wear checked | Yes | No |
| Adjustment required | Yes | No |

13. Track Shoe Cap Screws

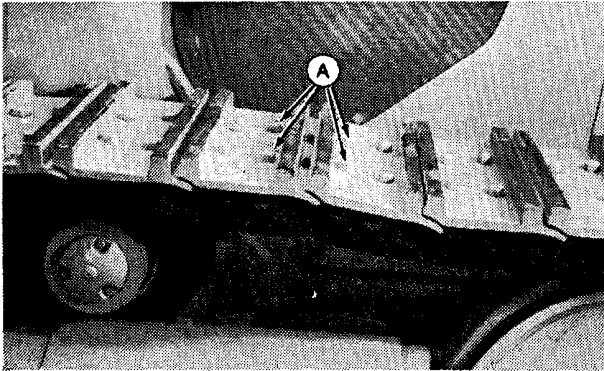

Fig. 69-Track Shoe Cap Screws

T93544

Tighten all cap screws (A) to 550-600 lb-ft (746-813 N·m).

Cap screws tightened Yes No

14. Lubrication

Check each lubrication point shown on the following pages. If necessary, lubricate with grease specified in Fuels and Lubricants group.

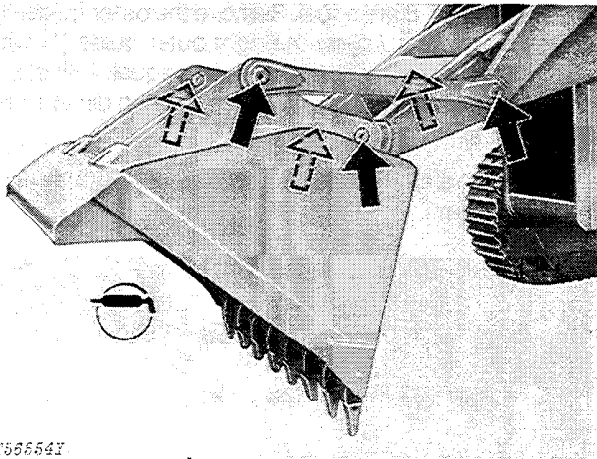

Fig. 70-Bucket Linkage Pivots (6 Points)

T56654Y

T56654Y

Lubricant required Yes No

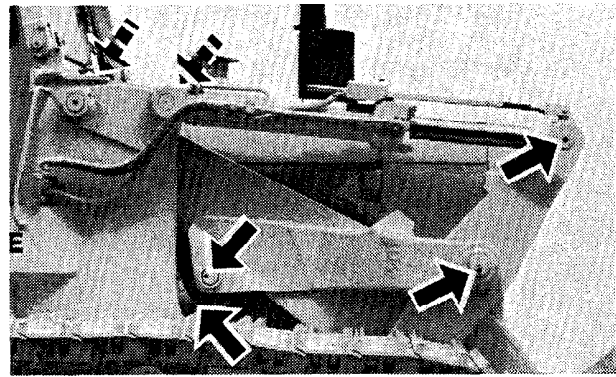

Fig. 71-Loader Linkage Pivots (12 Points)

T93545

Lubricant required Yes No

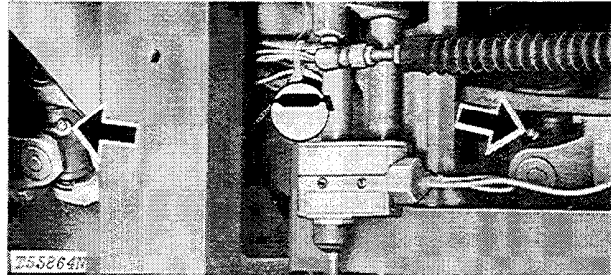

Fig. 72-Universal Joints (4 Points)

T55864N

Lubricant required Yes No

15. Cab Air Filter

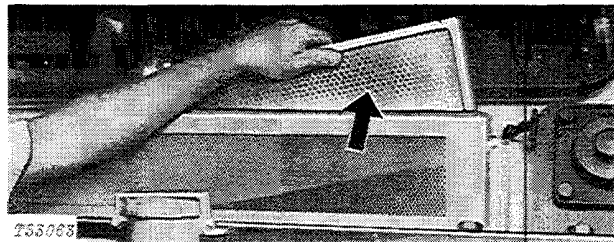

Fig. 73-Cab Air Filter

T53063

Clean and replace air filter.

Cab air filter cleaned Yes No

16. Batteries

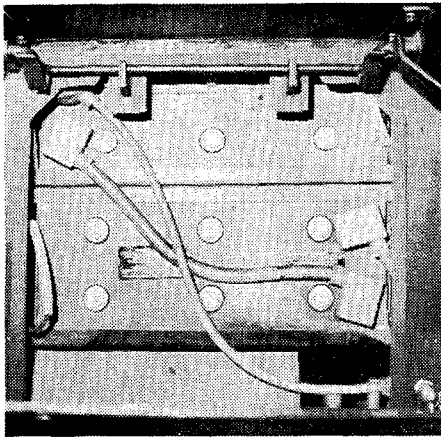

Fig. 74-Batteries

T88983

Check battery electrolyte level. If distilled water is not available, use clean soft water. Avoid use of hard water. Remove foreign material from top of battery and coat terminals with petroleum jelly.

Check battery connections.

| | | |
|--------------------------------|-----|----|
| Water added | Yes | No |
| Batteries checked and serviced | Yes | No |

17. Indicator Lights and Gauges

When operating the crawler, check the following gauges for correct operation.

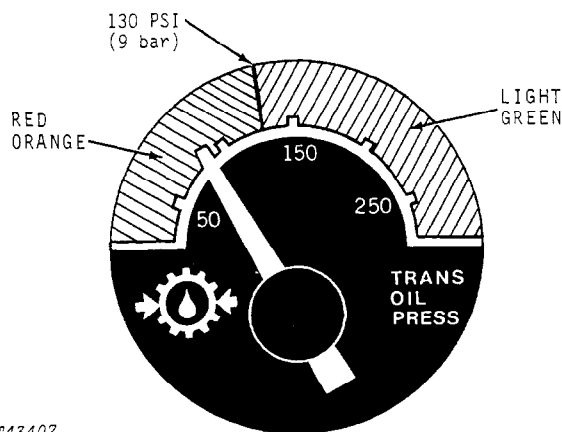

T43407

Fig. 75-Transmission Oil Pressure Gauge

T43407

Normal operating range is in the light green zone.

Check transmission oil pressure gauge during operation. If transmission oil pressure is not in the light green zone, shut off engine. Check transmission oil level. If oil is at proper level, troubleshoot the transmission system, checking for bent or broken lines and hoses. Also check for excessive leakage.

Transmission oil pressure may register slightly above the green zone in neutral or at full engine speed.

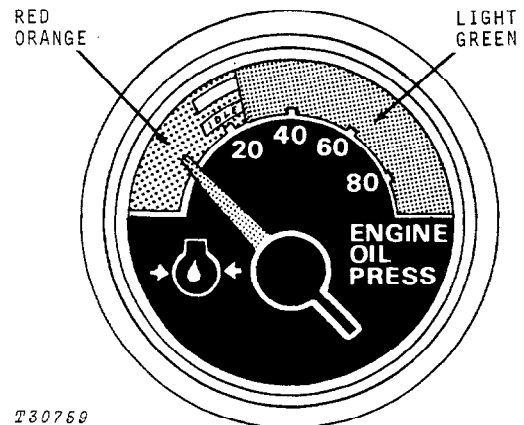

T30759

Fig. 76-Engine Oil Pressure Gauge

T30759

If the indicator hand of the engine oil pressure gauge drops into the red-orange zone, stop the crawler and check engine oil level. If oil level is not low, check for restrictions in oil lines or incorrect viscosity oil.

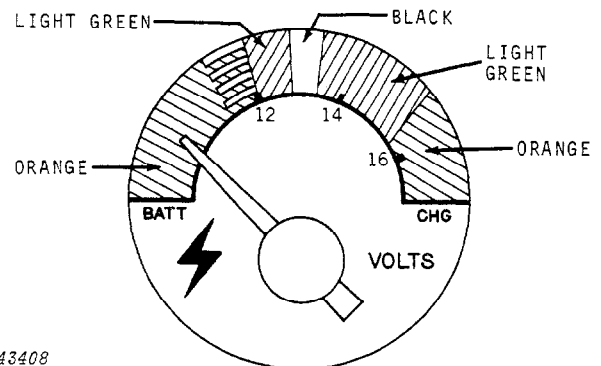

T43408

Fig. 77-Voltmeter

T43408

With key switch on and engine off, the indicator should be in the lower left light green zone.

When cranking the engine, the indicator will fall into the left-hand orange zone. When the engine starts, the indicator should move to stay in the right-hand light green zone.

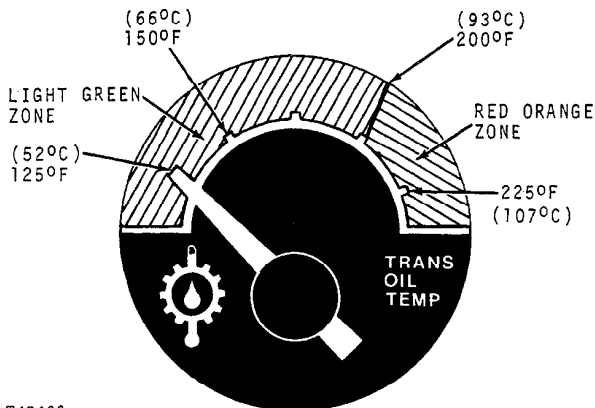

T43409

T43409

Fig. 78-Transmission Oil Temperature Gauge

Do not permit this temperature to exceed 200°F (93°C). If the temperature reaches this point during operation, stop the engine and locate the trouble.

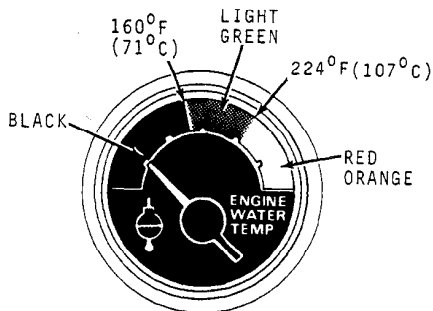

T38572

T38572

Fig. 79-Engine Water Temperature Gauge

Normal operating temperature is in the light green zone.

If the indicator hand of the engine water temperature gauge goes into the red-orange zone, check cooling system.

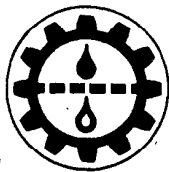

T23111N

T23111N

Fig. 80-Transmission Oil Filter Indicator Light

NOTE: Light should glow, if operative, with key switch in start position and engine off.

When the engine is running, the transmission oil filter restriction indicator light should go out, indicating that there is no restriction in the transmission and oil filters. If light glows red while the engine is running, stop engine and determine cause.

Litho in U.S.A.

The transmission oil filter indicator light glows red also if the pressure switch located with the engine oil pressure sending unit is faulty, if the engine oil pressure is low, or if the oil is cold during initial startup.

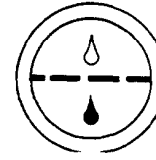

T38471N

Fig. 81-Hydraulic Filter Restriction Indicator Light

NOTE: Light should glow, if operative, with key switch in start position and engine off.

When the engine is running, the hydraulic oil filter indicator light should go out. If light glows red while the engine is running, stop engine and determine cause. Light may glow during initial operation until oil warms.

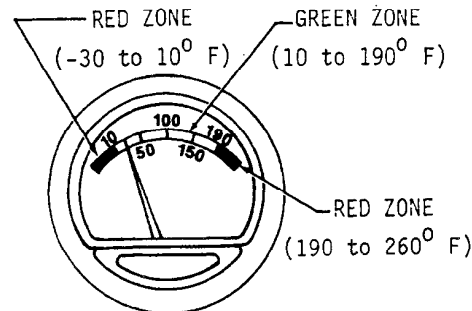

T93246

Fig. 82-Audio Visual Temperature Warning Device (Steel Mill - Water Glycol Only)

Immediately after starting, the gauge will read in the red zone and the buzzer will sound. After warm-up, normal operation will show green and the buzzer will stop.

Do NOT move loader control lever until gauge is green and buzzer has stopped.

Gauges operational

Yes No

18. Charging System

With key switch on and engine off, the indicator on the voltmeter should be in the lower left light green zone.

When cranking the engine, the indicator will fall into the left-hand orange zone. When the engine starts the indicator should move to and stay in the right-hand light green zone.

If the above conditions are met, the system is in proper working order.

Charging system operational

Yes No

19. Hydraulic Brake (Park Brake)

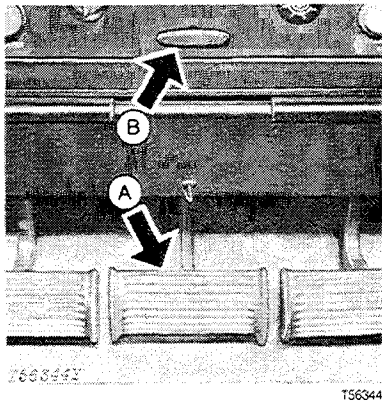

A—Park Brake Pedal B—Park Brake Lock Knob

Fig. 83-Park Brake

Depress brake pedal and pull lock knob up. Release brake pedal; brakes will lock in the desired position.

To disengage park brake, step on pedal.

If park brake does not stop machine, adjust as follows:

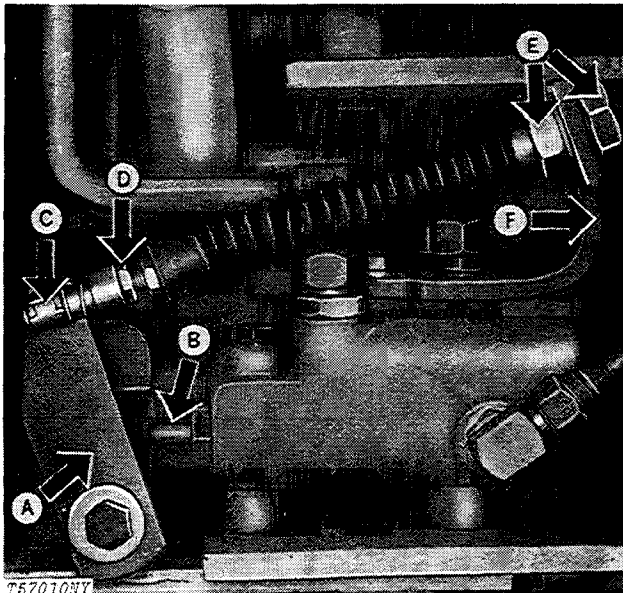

A—Brake Lever D—Locking Nut
 B—Brake Valve Plunger E—Bulkhead Cable Fittings
 C—Ball Joint F—Cable Support

Fig. 84-Brake Valve Linkage Adjustment

- 1 - Depress brake pedal against the pedal stop. The brake valve plunger (B, Fig. 84) should bottom out at the same time or just before the brake pedal bottoms out. In no case should the cable be heavily loaded by applying the brake pedal.
- 2 - If it does not bottom out completely or bottoms out too soon, loosen locking nut (D).
- 3 - Unhook ball joint (C) from brake lever (A).
- 4 - Turn ball joint until it will hold the brake lever in far enough so that the brake valve spool bottoms out at the same time as the brake pedal or just before.
- 5 - Hook ball joint to brake lever.
- 6 - Tighten locking nut.
- 7 - If additional adjustment is required, adjust bulkhead cable fittings (E) on cable support (F).
- 8 - With the brake pedal in the latched position, check that the brakes are fully applied.

| | | |
|---------------------|-----|----|
| Park brake checked | Yes | No |
| Adjustment required | Yes | No |

20. Fluid Leakage

Check the following systems for leakage due to poor or faulty connections and broken hoses or lines.

| | | |
|-----------------------------------|-----|----|
| A. Cooling system checked OK | Yes | No |
| B. Hydraulic system checked OK | Yes | No |
| C. Transmission system checked OK | Yes | No |
| D. Fuel system checked OK | Yes | No |
| E. Steering system checked OK | Yes | No |

If answer to any of the above is no, please explain.

Group V FUELS AND LUBRICANTS

GENERAL INFORMATION

Illustrated below is a periodic service chart mounted on the outside of the left console (without cab) or outside the left side of the cab. More detailed information on servicing the crawler can be found in the current operator's manual.

Use the operator's manual and periodic service chart as references when servicing the crawler. Remind your customer to thoroughly read the operator's manual before attempting to service or operate the crawler.

PERIODIC MAINTENANCE T77249
REFER TO OPERATOR'S MANUAL FOR DETAILED INFORMATION

| INTERVAL HOURS | ITEM NO. | ITEM | MAINTENANCE POINTS | DESCRIPTION | APPROVED MATERIAL |
|----------------|----------|---|--------------------|--|----------------------------------|
| AS REQUIRED | 2 | AIR CLEANER RESTRICTION | 1 | CHECK INDICATOR — CLEAN OR REPLACE ELEMENT (A) | JD FILTER |
| | 17 | FUEL TANK PUMP | 1 | DRAIN WATER AND SEDIMENT BEFORE STARTING (A) | |
| | 3 | INJECTION PUMP SEDIMENT BOWL & SCREEN | 1 | CHECK — CLEAN (A) | |
| | 1 | BELTS | 2 OR 3 | INSPECT AND CHECK TENSION (A) | |
| | 24 | TRACK SAG | 2 | CHECK — ADJUST 1 IN (25.4 MM) TO 1.5 IN (38 MM) (A) | MPG — SEE LUBRICANTS (A) |
| 10 OR DAILY | 5 | ENGINE OIL LEVEL | 1 | CHECK | EO — SEE LUBRICANTS |
| | 30 | RADIATOR COOLANT LEVEL (B) | 1 | CHECK — FILL TO 1 IN (25.4 MM) BELOW BOTTOM OF FILLER NECK | PROPER COOLANT (A) |
| | 11 | TRANSMISSION OIL LEVEL | 1 | CHECK — MIDWAY IN SIGHT GLASS | JD ALL WEATHER HYDROSTATIC FLUID |
| | 18 | HYDRAULIC SYSTEM OIL LEVEL | 1 | CHECK — MIDWAY IN SIGHT GLASS | JD HY-GARD (A) |
| | 31 | BUCKET LINKAGE | 8 | GREASE — UNTIL IT ESCAPES AT JOINTS | MPG — SEE LUBRICANTS (A) |
| 50 | 8 | SPLITTER OIL LEVEL | 1 | CHECK — DO NOT OVERFILL | SAE 30 CD (E) (A) |
| 100 | 28 | LOADER PIVOT POINTS | 12 | GREASE — UNTIL IT ESCAPES AROUND SEAL | MPG — SEE LUBRICANTS (A) |
| | 10 | BATTERY WATER LEVEL | 1 | CHECK — TO BOTTOM OF FILLER NECK — CLEAN AND TIGHTEN TERMINALS | DISTILLED WATER |
| 200 | 29 | ENGINE OIL (B) (C) | 1 | DRAIN WARM AND REFILL 26.5 QTS (24.5 L) | EO — SEE LUBRICANTS |
| | 25 | ENGINE OIL BYPASS FILTER (A) | 1 | REPLACE | JD FILTER |
| | 6 | ENGINE OIL FILTER | 1 | REPLACE | JD FILTER |
| | 14 | INNER AND OUTER FINAL DRIVE OIL LEVEL | 4 | CHECK — BOTTOM OF CHECK PLUG HOLE | GL 3 OIL SAE 80W/90 (A) |
| 500 | 21 | TRANSMISSION DRIVE SHAFT UNIVERSAL JOINTS | 4 | GREASE — UNTIL IT ESCAPES AROUND ALL BEARING CAP SEALS (A) | MPG — SEE LUBRICANTS (A) |
| | 7 | FUEL FILTER | 2 | REPLACE | JD FILTER |
| | 27 | COOLANT CONDITIONER FILTER (A) | 1 | REPLACE | JD FILTER |
| | 23 | AIR INTAKE HOSES | 1 | CHECK FOR CRACKS AND LOOSE CONNECTIONS (A) | |
| 1000 | 6 | SPLITTER GEAR BOX | 1 | DRAIN AND REFILL 6 QTS (5.7 L) — DO NOT OVERFILL | SAE 30 CD (E) (A) |
| | 15 | INNER FINAL DRIVE HOUSING | 2 | DRAIN & REFILL 5.33 GALS (20 L) PER SIDE | GL 3 OIL SAE 80W/90 (A) |
| | 13 | OUTER FINAL DRIVE HOUSING | 2 | DRAIN & REFILL 2.5 GALS (10.2 L) PER SIDE | GL 3 OIL SAE 80W/90 (A) |
| | 28 | ENGINE VALVE LASH | 1 | ADJUST: INT 0.15 IN (3.8 MM) EXH 0.25 IN (6.35 MM) (A) | |
| | 4 | ENGINE SPEED LINKAGE | 1 | CHECK AND ADJUST (A) | |
| | 22 | ENGINE CRANKCASE VENT TUBE | 1 | REMOVE AND CLEAN (A) | |
| 3000 | 18 | HYDRAULIC SYSTEM OIL | 1 | DRAIN & REFILL 29 GALS (110 L) | JD HY-GARD (A) |
| | 20 | HYDRAULIC SYSTEM OIL FILTER | 2 | REPLACE | JD FILTER |
| | 16 | HYDROSTATIC TRANSMISSION OIL | 3 | DRAIN AND REFILL 38.75 GALS (146.7 L) (A) | JD ALL WEATHER HYDROSTATIC FLUID |
| | 12 | TRANSMISSION FILTER | 4 | REPLACE (A) | JD FILTER |

(A) — SEE OPERATOR'S MANUAL
 (B) — FOR BREAKIN OR REBUILD SEE OPERATOR'S MANUAL
 (C) — REDUCE DRAIN INTERVAL TO ONE-HALF OF NORMAL IF MORE THAN 0.5 PERCENT SULFUR IN FUEL
 (D) — EVERY FALL CHECK HOSES, DRAIN, FLUSH AND REFILL PER OPERATOR'S MANUAL 10.5 GALS (40 L)
 (E) — API SERVICE CD/SC (MIL-L-210M) ENGINE OIL MEETING TO 4 OIL 1621

LUBRICANTS

| RECOMMENDED LUBRICANTS | AIR TEMPERATURE RANGE DURING FILL PERIOD | | | | | | | | | | |
|--|--|-----|-----|-----|-----|----|----|----|----|-----|-----|
| | *F | -40 | -22 | -4 | 14 | 32 | 50 | 68 | 86 | 104 | 122 |
| | *C | -40 | -30 | -20 | -10 | 0 | 10 | 20 | 30 | 40 | 50 |
| [EO] ENGINE OIL USE — JOHN DEERE TORO-GARD SUPREME • ENGINE OILS MEETING — API CD/SC (MIL-L-210M) (1) — MAY BE API CD/SC OR MIL-L-46152, BUT DRAIN INTERVAL IS REDUCED TO ONE-HALF OF NORMAL | <div style="text-align: center;"> </div> | | | | | | | | | | |
| [MPG] MULTIPURPOSE GREASE USE — SAE MULTIPURPOSE EP GREASE CONTAINING 3 TO 5% MOLYBDENUM DISULFIDE IS PREFERRED • JOHN DEERE HIGH TEMPERATURE/EP GREASE • SAE MULTIPURPOSE EP GREASE | <div style="text-align: center;"> </div> | | | | | | | | | | |

Fig. 1-Periodic Service Chart

FUELS

Fuel Specifications

Use ONLY clean, high-quality fuel.

Use Grade No. 2-D fuel above 40°F (4°C).

Use Grade No. 1-D fuel at temperatures below 40°F (4°C). Use Grade 1-D fuel for all air temperatures at altitudes above 5000 ft. (1 500 m).

IMPORTANT: If fuel sulfur content exceeds 0.5 percent, the engine oil drain interval must be reduced by 50 percent (to 100 hours).

Use fuel with less than 1.0 per cent sulfur. If possible, use fuel with less than 0.5 per cent sulfur.

For maximum filter life, sediment and water should not exceed 0.10 per cent.

The cetane number should be 40 minimum. If you operate your crawler loader where air temperatures are normally low or where altitudes are high, you may need fuel with a high cetane number.

Cloud Point - For cold weather operation, cloud point should be 10°F (6°C) below lowest normal air temperature.

Storing Fuels

NOTE: Diesel fuels stored for a long time may form gum and plug filters.

Keep fuel in a container in a protected area. Water and sediment must be removed before fuel gets to the engine. Do not use de-icers to remove water from fuel. Do not depend on fuel filters to remove water.

If possible, install a water separator at the storage tank outlet.

Store fuel drums on their sides with their plugs up.

IMPORTANT: Keep all dirt, scale, water, and other foreign matter out of fuel.

Filling the Fuel Tank

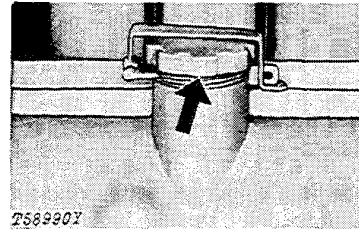

Fuel Tank Filler Cap

The fuel tank is located at the rear of the crawler loader.

Fill fuel tank at end of each day's operation.

Fuel tank capacity is 106 U.S. gal. (401.3 L).

To help keep water out of fuel system, drain the fuel tank for several seconds before you start the engine.

CAUTION: Handle fuel carefully. Do not fill fuel tank when the engine is hot or running. Do not smoke while you fill fuel tank or work on fuel system.

LUBRICANTS

Storing Lubricants

Your crawler can operate at top efficiency only if clean lubricants are used. Use clean containers to handle all lubricants. Store them in an area protected from dust, moisture, and other contamination.

Effective use of lubricating oils and greases is perhaps the most important step toward low upkeep cost, long crawler life, and satisfactory service. Use only lubricants specified in this section, apply them at intervals and according to the instructions in the lubrication and periodic service section.

Engine Oil

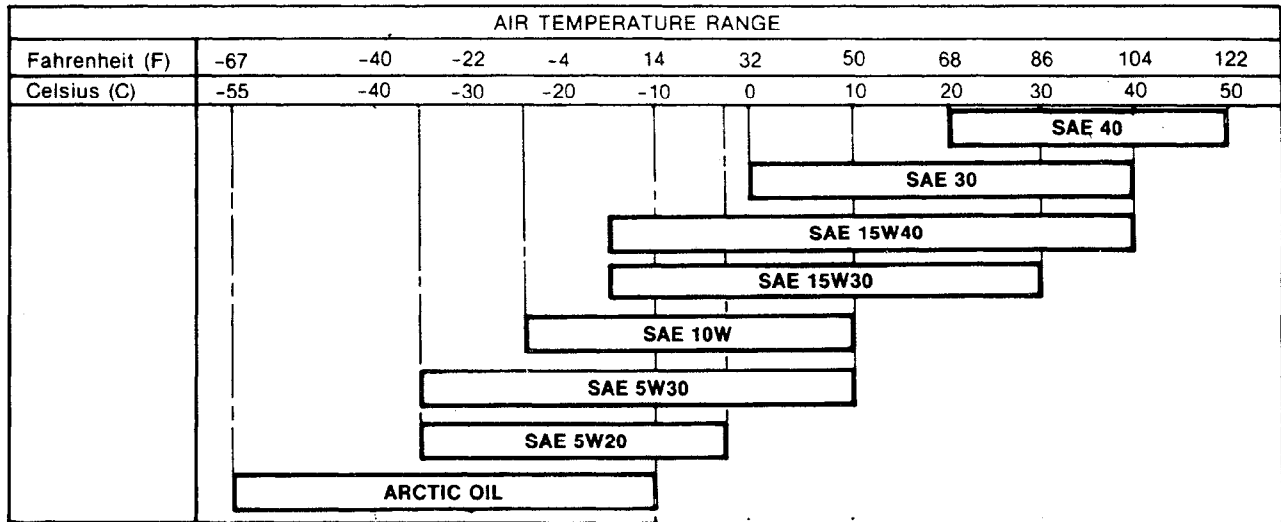

T91372

Depending on the expected air temperature range between oil changes, use oil viscosity shown on the chart above.

Additives are not required nor recommended.

John Deere TORQ-GARD SUPREME® engine oil is recommended. If other oils are used, they must have the following minimum specifications.

Oil Specification

Use

API Service CD/SC
 (MIL-L-2104C)

Recommended

API Service CC/SC•
 or MIL-L-46152•

For SAE 5W20, SAE 5W30 and arctic oil only, use if recommended oil is not available

MIL-L-46167•

For arctic oil only

- Change oil at 100 hours, which is half the normal drain interval.

Transmission Oil

Use:

John Deere All-Weather Hydrostatic Fluid

Oils meeting John Deere Standard JDM J21A

Final Drive Oil

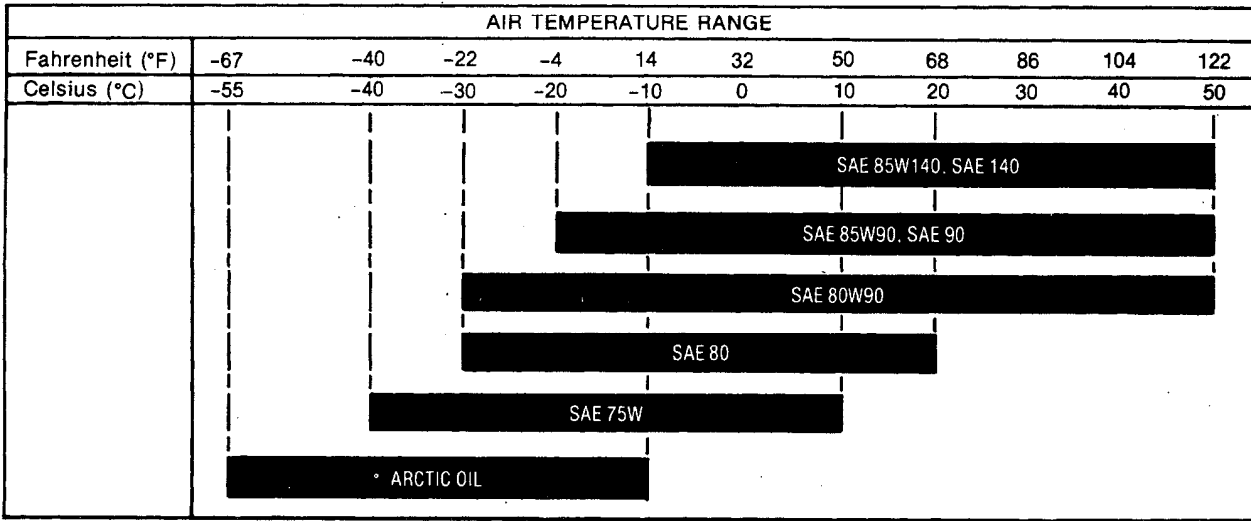

T88972

Depending upon the expected air temperature range between oil changes, use oil viscosity shown on the temperature chart above.

The following oils are recommended.

John Deere API GL-5 Gear Oil

Oils meeting API Service GL-5 (MIL-L-2105B or MIL-2105C)

Oil meeting MIL-L-10324A may be used as arctic oil.

Splitter Drive Oil

Use SAE 30 Engine oil meeting API Service CD/SC (MIL-L-2104C), CC/SC, or MIL-L-46152.

Track Roller, Front Idler, and Carrier Roller Oil

For 855 Crawler Loader, use SAE 80W90 gear oil meeting API Service GL-5 (MIL-L-2105B or MIL-L-2105C).

For 855 Steel Mill Loader, use ONLY SAE 30 engine oil meeting API Service CD/SC (MIL-L-2104C), CC/SC or MIL-L-46152.

Section 1 TRACKS

CONTENTS OF THIS SECTION

| | Page | | Page |
|---|----------|---|---------|
| GROUP 0130 - TRACK SYSTEMS | | GROUP 0130 - TRACK SYSTEMS (Continued) | |
| Rock Guards and Track Guides | | Front Idler | |
| General Information | 0130-3 | General Information | 0130-23 |
| Removal | 0130-3 | Measuring Front Idler Wear | 0130-23 |
| Repair | 0130-3 | Removal | 0130-23 |
| Installation | 0130-3 | Repair | 0130-24 |
| Carrier Rollers | | Installation | 0130-28 |
| General Information | 0130-4 | Adjustment | 0130-28 |
| Measuring Carrier Roller Wear | 0130-4 | Track Adjuster Cylinder | |
| Removal | 0130-4 | General Information | 0130-29 |
| Repair | 0130-5 | Removal | 0130-29 |
| Installation | 0130-7 | Repair | 0130-29 |
| Track Rollers | | Installation | 0130-30 |
| General Information | 0130-8 | Recoil Spring | |
| Measuring Track Roller Wear | 0130-8 | General Information | 0130-31 |
| Removal | 0130-8 | Removal | 0130-31 |
| Repair | 0130-8 | Repair | 0130-32 |
| Installation | 0130-11 | Installation | 0130-33 |
| Track Shoes | | Track Frame | |
| General Information | 0130-12 | General Information | 0130-33 |
| Measuring Track Shoe Wear | 0130-12 | Removal | 0130-33 |
| Removal | 0130-12 | Repair | 0130-34 |
| Repair | 0130-12 | Track Frame Wear Strips | 0130-35 |
| Installation | 0130-12 | Installation | 0130-36 |
| Non-Lubricated Track Chain Assembly | | Sprocket | |
| General Information | 0130-13 | General Information | 0130-37 |
| Measuring Non-Lubricated Track | | Measuring Sprocket Wear | 0130-37 |
| Chain Wear | 0130-13A | Removal | 0130-37 |
| Link Height | 0130-14A | Repair | 0130-37 |
| Bushing Outside Diameter | 0130-14A | Installation | 0130-38 |
| Track Pitch | 0130-14B | | |
| Removal | 0130-14B | | |
| Repair | 0130-16 | | |
| Disassembly | 0130-16 | | |
| Assembly | 0130-18 | | |
| Use of Shims for Assembly | | | |
| of Used Track Components | 0130-21 | | |
| Rotating Pins and Bushings | 0130-21 | | |
| Installation | 0130-21 | | |

<https://www.ebooklibonline.com>

Hello dear friend!

Thank you very much for reading.

Enter the link into your browser.

The full manual is available for immediate download.

<https://www.ebooklibonline.com>

| | Page |
|---|---------|
| GROUP 0130 - TRACK SYSTEMS (Continued) | |
| Lubricated Track Chain | |
| Measure Link Height | 0130-39 |
| Measure Bushing Outside Diameter ... | 0130-39 |
| Measure Track Pitch | 0130-40 |
| Remove | 0130-41 |
| Disassemble | |
| To Turn Bushings and Relubricate | 0130-42 |
| To Turn Pins and Bushings and Not Relubricate | 0130-54 |
| To Repair a Dry Joint or Broken Link and Relubricate | 0130-61 |
| Assemble | |
| To Turn Bushings and Relubricate | 0130-45 |
| To Turn Pins and Bushings and Not Relubricate | 0130-57 |
| To Repair a Dry Joint or Broken Link and Relubricate | 0130-64 |
| Install | 0130-69 |

| | |
|--|---------|
| GROUP 0199 - SPECIFICATIONS AND SPECIAL TOOLS | |
| Specifications and Torque Values | |
| Track Systems | 0199-1 |
| Special Tools | |
| Track Systems | 0199-10 |



Suggest:

If the above button click is invalid.

Please download this document

first, and then click the above link

to download the complete manual.

Thank you so much for reading

Group 0130 TRACK SYSTEMS

ROCK GUARDS AND TRACK GUIDES

GENERAL INFORMATION

Rock guards and track guides help prevent rocks and debris from entering the track system. They also help to keep the tracks centered on the rollers.

REMOVAL

Remove bolts (1, Fig. 1) and cap screws (3 and 7) to remove rock guards (5 and 6) and track guides (2 and 14).

REPAIR

Inspect rock guards (5 and 6) and track guides (2 and 14) for wear and damage and repair or replace parts as necessary.

If welding is required, use an E-7018 electrode.

IMPORTANT: Disconnect battery ground strap or turn off battery disconnect switch before doing any welding on the crawler. Failure to do so may damage the electrical system.

INSTALLATION

Apply John Deere Loctite Thread Lock and Sealant High Strength or equivalent to rock guard and track guide to track frame cap screws.

Install inner rock guard (5, Fig. 1) and inner guide (2) and secure with cap screws.

Install bolts (1) through inner rock guard and track guide and install spacers (10) on bolts (1).

Install outer rock guard (6) and outer guide and secure with cap screws.

Install washers (13) and nuts (9) on bolts (1). Tighten nuts to 300 lb-ft (407 Nm) (41 kg-m).

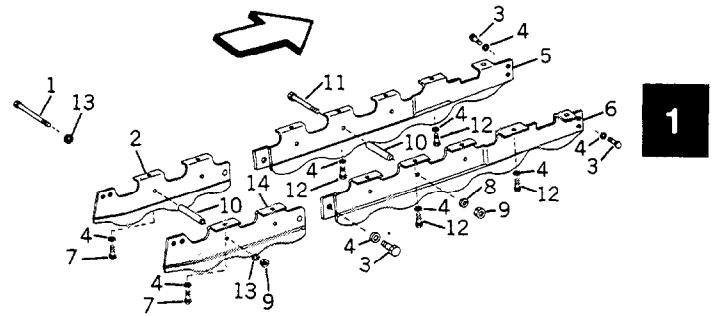

T61226N

- | | |
|----------------------|------------------------|
| 1—Bolt (3 used) | 8—Lock Washer (8 used) |
| 2—Left Rear Guide | 9—Nut (7 used) |
| 3—Cap Screw (6 used) | 10—Spacer (7 used) |
| 4—Washer (20 used) | 11—Bolt (4 used) |
| 5—L.H. Rock Guard | 12—Cap Screw (8 used) |
| 6—R.H. Rock Guard | 13—Washer (12 used) |
| 7—Cap Screw (4 used) | 14—Right Rear Guide |

Fig. 1-Rock Guards