

# T M

## Technical Manual

### John Deere JD670 Motor Grader

TM-1134



## SECTION AND GROUP CONTENTS OF THIS MANUAL

### SECTION I - GENERAL INFORMATION

- Group I - Contents, Index and Page List
- Group II - Introduction and Safety Information
- Group III - General Specifications
- Group IV - Predelivery, Delivery and After-Sale Services
- Group V - Lubrication

### SECTION 1 - WHEELS AND TIRES

- Group 0110 - Powered Wheels, Tires and Fastenings
- Group 0120 - Non-Powered Wheels, Tires and Fastenings
- Group 0199 - Specifications and Special Tools

### SECTION 2 - AXLES AND SUSPENSION SYSTEMS

- Group 0201 - Drive Axle Housings
- Group 0210 - Differential
- Group 0230 - Non-Powered Wheel Axles
- Group 0250 - Axle Shaft, Bearings and Reduction Gears
- Group 0299 - Specifications and Special Tools

### SECTION 3 - TRANSMISSION

- Group 0315 - Controls
- Group 0341 - Housings and Covers
- Group 0350 - Gears, Shafts, Bearings and Power Shift Clutch
- Group 0360 - Transmission Hydraulics
- Group 0370 - Clutch Disconnect and Controls
- Group 0399 - Specifications and Special Tools

### SECTION 4 - ENGINES

- Group 0400 - Removal and Installation
- Group 0401 - Crankshaft and Main Bearings
- Group 0402 - Camshafts and Valve Actuating Means
- Group 0403 - Connecting Rods and Pistons
- Group 0404 - Cylinder Block
- Group 0407 - Engine Oiling System
- Group 0408 - Ventilating System
- Group 0409 - Cylinder Head and Valves
- Group 0410 - Exhaust Manifold
- Group 0413 - Fuel Injection System
- Group 0414 - Intake Manifold
- Group 0416 - Turbocharger
- Group 0417 - Water Pump
- Group 0418 - Thermostats, Housings and Piping
- Group 0419 - Engine Oil Cooler
- Group 0420 - Fuel Filter and Primer Pump
- Group 0421 - Fuel Transfer Pump
- Group 0422 - Starting System
- Group 0433 - Flywheel, Housing and Fasteners
- Group 0499 - Specifications and Special Tools

### SECTION 5 - ENGINE AUXILIARY SYSTEMS

- Group 0505 - Cold Weather Starting Aids
- Group 0510 - Engine Cooling Systems
- Group 0515 - Speed Controls
- Group 0520 - Intake System
- Group 0560 - External Fuel Supply Systems
- Group 0599 - Specifications and Special Tools

### SECTION 8 - TRANSFER DRIVE

- Group 0841 - Housings and Covers
- Group 0851 - Gears, Shafts and Bearings
- Group 0899 - Specifications and Special Tools

### SECTION 9 - STEERING SYSTEM

- Group 0960 - Power Steering
- Group 0999 - Specifications and Special Tools

### SECTION 10 - SERVICE BRAKES

- Group 1011 - Service Brakes Active Elements
- Group 1015 - Controls Linkage
- Group 1066 - Brakes Hydraulics
- Group 1099 - Specifications and Special Tools

### SECTION 11 - PARKING-EMERGENCY BRAKES

- Group 1111 - Parking Brake Active Elements
- Group 1115 - Controls Linkage
- Group 1199 - Specifications and Special Tools

### SECTION 15 - EQUIPMENT ATTACHING

- Group 1511 - Drawbar

### SECTION 16 - ELECTRICAL SYSTEMS

- Group 1671 - Batteries, Support and Cables
- Group 1672 - Alternator, Regulator and Charging System Wiring
- Group 1673 - Vehicle Lighting System
- Group 1674 - Wiring Harness and Switches
- Group 1675 - Automatic Control Systems and Controls
- Group 1676 - Instrument and Indicators
- Group 1699 - Specifications and Special Tools

### SECTION 17 - FRAME, CHASSIS OR SUPPORTING STRUCTURE

- Group 1740 - Frame Installation
- Group 1746 - Bottom Guards
- Group 1799 - Specifications and Special Tools

**SECTION AND GROUP CONTENTS OF THIS MANUAL—Continued**

**SECTION 18 - OPERATOR'S STATION**

- Group 1806 - Safety Equipment
- Group 1808 - Comfort and Convenience Items
- Group 1810 - Operator Enclosure
- Group 1821 - Seat
- Group 1830 - Heating
- Group 1899 - Specifications and Special Tools

**SECTION 19 - SHEET METAL**

- Group 1910 - Hood or Engine Enclosure
- Group 1921 - Grille and Grille Housing

**SECTION 21 - MAIN HYDRAULIC SYSTEM**

- Group 2160 - Hydraulic System
- Group 2199 - Specifications and Special Tools

**SECTION 34 - GRADING DEVICE**

- Group 3401 - Blade
- Group 3415 - Controls Linkage
- Group 3440 - Grading Device Frames
- Group 3450 - Circle Gear Box
- Group 3460 - Hydraulic System
- Group 3499 - Specifications and Special Tools

**SECTION 42 - GROUND CONDITIONING TOOLS**

- Group 4201 - Teeth and Shanks
- Group 4215 - Controls Linkage
- Group 4240 - Frames
- Group 4260 - Hydraulic System
- Group 4299 - Specifications and Special Tools

**SECTION 90 - SYSTEM TESTING**

- Group 9005 - General Information - Seven Basic Steps of Testing and Diagnosis
- Group 9010 - Engine
- Group 9015 - Electrical System
- Group 9020 - Power Train
- Group 9025 - Hydraulic System
- Group 9030 - Miscellaneous Components
- Group 9032 - Automatic Blade Control
- Group 9035 - Specifications and Special Tools

**<https://www.ebooklibonline.com>**

Hello dear friend!

Thank you very much for reading.

Enter the link into your browser.

The full manual is available for immediate download.

**<https://www.ebooklibonline.com>**

## ALPHABETICAL INDEX

<b>A</b>	
Accessory relay .....	1676-7
Accumulator .....	1060-7
Accumulator, bladder-type .....	2160-21
Accumulator, noise suppression .....	2160-12
After-sale inspection .....	I-IV-15
Alternator indicator light .....	1676-5
Alternator, regulator and charging system wiring .....	1672-1
Automatic blade control testing .....	9032-1
Automatic control linkages .....	4615-3
Automatic controls .....	4615-1
Axle shafts, bearings, and reduction gears ..	0250-1
Axles, non-powered wheel .....	0230-1
<b>B</b>	
Bail assembly linkages .....	4615-7
Batteries, supports and cables .....	1671-3
Bench seat .....	1821-3
Bevel drive .....	0210-1
Bladder-type accumulator .....	2160-12
Blade .....	3401-3
Blade lift control valve linkage .....	3415-1
Blade rotation and blade side-shift control valve linkage .....	3415-4
Blade tilt control valve linkage .....	3415-6
Block, cylinder .....	0404-1
Bottom guard .....	1746-1
Brake caliper assembly .....	1111-7
Brake pressure indicator light .....	1676-4
Brake valve .....	1060-1
Bumper .....	1910-6
Bypass valve .....	2160-19
<b>C</b>	
Camshaft .....	0402-3
Case and covers, transmission .....	0341-4
Cigar lighter .....	1808-1
Circle and blade tilt assemblies .....	3440-5
Circle drive motor .....	3460-16
Circle gear box .....	3450-1
Circle linkages .....	4615-3
Circle side-shift control valve linkage .....	3415-5
Clutch elements, transmission .....	0370-4
Clutch housing, transmission .....	0341-1
Clutch linkage, transmission .....	0370-1
Clutch pedal valve linkage, transmission ....	0315-3
Clutch pedal valve, transmission .....	0360-8
Clutch shaft and carrier assembly, transmission .....	0370-3
Clutch valve linkage, transmission .....	0315-3
Cold weather starting aids .....	0505-3
Comfort and convenience items .....	1808-1
Connecting rods .....	0403-3
Console, control .....	4670-2
Control console .....	4670-2
Control mounting structure .....	1810-7
Control valve assembly, transmission .....	0360-4
Controls linkage .....	3415-1
Controls linkage, parking and emergency brakes .....	1115-1
Controls linkage, service brakes .....	1015-1
Controls, speed .....	0515-1
Cooler, oil .....	2160-19
Crankshaft .....	0401-1
Crankshaft front oil seal .....	0401-3, 0402-3
Crankshaft gear .....	0401-2
Crankshaft rear wear sleeve .....	0401-5
Crossover relief valve .....	3460-8
Cylinder block .....	0404-1
Cylinder head and valves .....	0409-1
Cylinder liner .....	0404-2
Cylinder, rear steer .....	0960-17
Cylinder, ripper .....	4260-18
Cylinder, scarifier .....	4260-17
Cylinder, wheel lean .....	0960-20
Cylinders, front steer and rear steer .....	0960-20
Cylinders, hydraulic .....	3460-20
Cylinders, steering .....	0960-16
<b>D</b>	
Damper, vibration .....	0401-3
Defroster fan .....	1810-9
Delco-Remy starting motor .....	0422-1
Delivery service .....	I-IV-15
Diagnosis and testing .....	9005-3
Differential .....	0210-1
Differential lock valve .....	0210-14
Differential pinion shaft .....	0210-8
Direction selector lever and linkage, transmission .....	0315-5
Disconnect and controls, transmission .....	0370-1
Draft frame .....	3440-4
Drawbar .....	1511-3
Drive axle housing and support .....	0201-3
Drive chain .....	0250-2
<b>E</b>	
Electrical components automatic controls ....	4670-1
Electrical system .....	1671-1
Electrical system automatic controls .....	1675-1
Electrical system testing .....	9015-1
Engine .....	0400-1
Engine auxiliary systems .....	0505-1
Engine cooling system .....	0510-1

Engine enclosure .....	1910-3
Engine frame .....	1740-3
Engine oil cooler .....	0419-1
Engine oil filters and housing .....	0407-3
Engine oil pressure gauge .....	1676-6
Engine oil pressure regulating valve .....	0407-3
Engine oil pump .....	0407-1
Engine oiling system .....	0407-1
Engine removal and installation .....	0400-3
Engine shields .....	1910-3
Engine testing .....	1910-1
Engine water temperature gauge .....	1676-5
Equipment attaching .....	1511-1
Exhaust manifold .....	0410-1
External fuel supply system .....	0560-1

**F**

Fan .....	0510-1
Fan, defroster .....	1810-9
Filter, fuel .....	0420-1
Filter, hydraulic return .....	2160-21
Final drive assembly .....	0250-7
Final drive housing .....	0201-6
Flywheel, housing and fastenings .....	0433-1
Forward and reverse modulator, transmission .....	0360-12
Frame, chassis or supporting structure .....	1740-1
Frame, draft .....	3440-4
Frame, engine .....	1740-3
Frame installation .....	1740-3
Frame, main .....	1740-6
Frames and housings, automatic controls .....	4640-1
Frames, grading device .....	3440-1
Frames, ripper .....	4240-3
Frames, scarifier .....	4240-1
Front oil seal and wear sleeve .....	0401-3
Front steer and rear steer cylinders .....	0960-20
Front windshield wiper .....	1810-10
Fuel filter .....	0420-1
Fuel gauge .....	1676-6
Fuel injection nozzles .....	0413-5
Fuel injection pump .....	0413-1
Fuel injection system .....	0413-1
Fuel lines .....	0560-3
Fuel supply system, external .....	0560-1
Fuel tank .....	0560-2
Fuel transfer pump .....	0421-1
Function control valves .....	3460-1

**G**

Gauge, engine oil pressure .....	1676-6
Gauge, engine water temperature .....	1676-5
Gauge, fuel .....	1676-6
Gauge, transmission oil pressure .....	1676-3

Gauge, transmission oil temperature .....	1676-6
Gear box, circle .....	3450-1
Gears, shafts, bearings and power shift clutch .....	0350-1
General specifications .....	III-1
Grade height jack .....	4615-6
Grade sensor .....	4670-3
Grading device .....	3401-1
Grading device frames .....	3440-1
Grille .....	1921-1
Ground conditioning tools .....	4201-1
Guard, bottom .....	1746-1

**H**

Head and valves, cylinder .....	0409-1
Heater .....	1830-1
High beam indicator light .....	1676-4
Hood .....	1910-3
Housing, final drive .....	0201-6
Housings and covers, transfer drive .....	0841-3
Housings and covers, transmission .....	0341-1
Hydraulic components automatic controls .....	4660-1
Hydraulic cylinders .....	3460-20
Hydraulic return filter .....	2160-21
Hydraulic system, main .....	2160-1
Hydraulic system testing .....	9025-1
Hydraulics, transmission .....	0360-1
Hydraulics, vehicle .....	2199-9

**I**

Idle gear assembly, upper and lower .....	0851-5
Input gear assembly .....	0851-4
Instrument and indicators .....	1676-1
Intake manifold .....	0414-1
Intake system .....	0520-1

**J**

John Deere starting motor .....	0422-11
---------------------------------	---------

**K**

Key switch .....	1676-7
------------------	--------

**L**

Lift arm assembly .....	3440-1
Lift arm locking valve and pin .....	3460-9
Light, alternator indicator .....	1676-5
Light, brake pressure indicator .....	1676-4
Light, high beam indicator .....	1676-4
Light, lock pin indicator .....	1676-4
Light, transmission filter restriction indicator light .....	1676-5
Lighting system .....	1673-1
Lights .....	1673-3
Lights, turn indicator .....	1676-4
Lines, fuel .....	0560-3

Linkage, blade lift control valve ..... 3415-1  
 Linkage, blade rotation and blade  
     side-shift control valve ..... 3415-4  
 Linkage, blade tilt control valve ..... 3415-6  
 Linkage, circle side-shift control valve ..... 3415-5  
 Linkage, controls ..... 3415-1  
 Linkage, rear steer ..... 0960-12  
 Linkage, rear steering control valve ..... 3415-2  
 Linkage, scarifier valve ..... 4215-1  
 Linkages, automatic control ..... 4615-3  
 Locking pin indicator light ..... 1676-4

**M**

Main bearings ..... 0401-1  
 Main frame ..... 1740-6  
 Main hydraulic pump ..... 2160-3  
 Main hydraulic system ..... 2160-1  
 Malfunctions:  
     Automatic blade control ..... 9032-10  
     Electrical system ..... 9015-11  
     Engine ..... 9010-5  
     Hydraulic system ..... 9025-31  
     Power train ..... 9020-12  
 Manifold, exhaust ..... 0410-1  
 Manifold, intake ..... 0414-1  
 Manifold, rotary ..... 3460-14  
 Manual steering ..... 0960-7  
 Meter, service ..... 1676-3  
 Miscellaneous components testing ..... 9030-1  
 Motor, circle drive ..... 3460-16

**N**

Neutral start switch ..... 1674-4  
 Noise suppression accumulator ..... 2160-12  
 Non-powered wheels ..... 0120-1  
 Non-powered wheel axles ..... 0230-1  
 Nozzles, fuel injection ..... 0413-5

**O**

Oil cooler, engine ..... 0419-1  
 Oil cooler, hydraulic ..... 2160-19  
 Oil filter assembly, transmission ..... 0360-14  
 Oil filter, engine ..... 0407-1  
 Oil filter nipple, engine ..... 0407-2  
 Oil pressure control valve ..... 0407-2  
 Oil pressure regulating valve,  
     transmission ..... 0360-10  
 Oil pump, engine ..... 0407-2  
 Oil pump, transmission ..... 0360-1  
 Oiling system, engine ..... 0407-1  
 Operator enclosure ..... 1810-1  
 Operator's station ..... 1806-1  
 Output gear assembly ..... 0851-6

**P**

Panels, rear ..... 1910-6  
 Parking brake active elements ..... 1111-3  
 Parking emergency brakes ..... 1111-1  
 Pistons ..... 0403-2  
 Platform ..... 1810-6  
 Power train testing ..... 9020-1  
 Powered, wheels ..... 0110-3  
 Pre-cleaner ..... 0520-2  
 Pre-delivery ..... I-IV-1  
 Pressure control valve ..... 2160-16  
 Pump drive assembly ..... 2160-10  
 Pump, fuel injection ..... 0413-1  
 Pump, fuel transfer ..... 0421-1  
 Pump, main hydraulic ..... 2160-3  
 Pump, water ..... 0417-1

**R**

Radiator ..... 0510-1  
 Rear crankshaft oil seal, housing,  
     and wear sleeve ..... 0401-3  
 Rear panels ..... 1910-6  
 Rear steer cylinder ..... 0960-17  
 Rear steer linkage ..... 0960-12  
 Rear steer valve ..... 0960-12  
 Rear steering control valve linkage ..... 3415-2  
 Rear steering indicator ..... 1676-3  
 Rear wiper ..... 1810-9  
 Reverse warning switch ..... 1674-4  
 Ripper cylinder ..... 4260-18  
 Ripper frames ..... 4240-3  
 Ripper valve ..... 4260-5  
 Ripper teeth and shanks ..... 4201-4  
 Rocker arms and push rods ..... 0402-15  
 Rotary manifold ..... 3460-14

**S**

Safety equipment ..... 1806-3  
 Scarifier cylinder ..... 4260-17  
 Scarifier frames ..... 4240-1  
 Scarifier teeth and shanks ..... 4201-3  
 Scarifier valve ..... 4260-1  
 Scarifier valve linkage ..... 4215-1  
 Seat ..... 1821-1  
 Seat, bench ..... 1821-3  
 Seat, suspension ..... 1821-1  
 Service brakes ..... 1011-1  
 Service brakes active elements ..... 1011-3  
 Service meter ..... 1676-3  
 Shaft and tube, steering ..... 0960-11  
 Sheet metal ..... 1910-1  
 Shields, engine ..... 1910-3  
 Shift lever and linkage, transmission ..... 0315-7  
 Solenoid, starting aid ..... 0505-3

Special tools:

Alternator, regulator and charging system wiring .....	1699-7
Automatic blade control testing .....	9035-21
Batteries, supports and cables .....	1699-5
Camshaft and valve actuating means .....	0499-34
Connecting rods and pistons .....	0499-35
Crankshaft and main bearings .....	0499-32
Cylinder block .....	0499-37
Cylinder head and valves .....	0499-40
Electrical system testing .....	9035-12
Engine frame .....	1799-1
Engine removal and installation .....	0499-31
Engine testing .....	9035-3
Flywheel, housing and fastenings .....	0499-50
Fuel injection system .....	0499-42
Ground conditioning tools hydraulic system .....	4299-4
Hydraulic system .....	9035-18
Linkages .....	4699-1
Power steering .....	0999-4
Starting motor and fastenings .....	0499-46
Transmission clutch disconnect and controls .....	0399-14
Transmission gears, shafts, bearings and power shift clutch .....	0399-13
Transmission hydraulics .....	0399-13
Turbocharger .....	0499-43
Vehicle hydraulics .....	2199-9
Water pump .....	0499-45

Specifications:

Alternator, regulator and charging system wiring .....	1699-1
Axle shafts, bearings and reduction gears .....	0299-9
Batteries, supports and cables .....	1699-1
Brakes hydraulics .....	1099-1
Cab .....	1899-1
Camshaft and valve actuating means .....	0499-3
Connecting rods and pistons .....	0499-7
Crankshaft and main bearings .....	0499-2
Cylinder block .....	0499-12
Cylinder head and valves .....	0499-14
Differential or bevel drive .....	0299-3
Drive axle housing and support .....	0299-1
Electrical system testing .....	9035-6
Engine break-in .....	0499-1
Engine cooling system .....	0599-1
Engine oil cooler .....	0499-23
Engine oiling system .....	0499-13
Engine testing .....	9035-1
External fuel supply system .....	0599-2
Flywheel housing and fasteners .....	0499-30
Fuel injection system .....	0499-16
Grading device hydraulic system .....	3499-3

Specifications—Continued

Ground conditioning tools hydraulic system .....	4299-1
Hydraulic system testing .....	9035-14
Instruments and indicators .....	1699-4
Lift arm assembly .....	3499-1
Lighting system .....	1699-3
Linkages .....	4699-1
Miscellaneous components testing .....	9035-19
Non-powered wheel axles .....	0299-8
Parking brake active elements .....	1199-1
Parking brake controls linkage .....	1199-2
Power steering .....	0999-1
Power train testing .....	9035-13
Speed controls .....	0599-2
Starting motor and fastenings .....	0499-24
Suspension seat .....	1899-2
Thermostats, housing and piping .....	0499-22
Transfer drive gears, shafts, and bearings .....	0899-3
Transfer drive housings and covers .....	0899-1
Transmission clutch disconnect and controls .....	0399-12
Transmission, gears, shafts, bearings and power shift clutch .....	0399-2
Transmission housing and covers .....	0399-1
Transmission hydraulics .....	0399-8
Turbocharger .....	0499-21
Vehicle hydraulics .....	2199-1
Water pump .....	0499-21
Wiring harness and switches .....	1699-3
Speed controls .....	0515-1
Start circuit relay .....	1674-3
Start switch .....	1676-7
Starting aid adapter, line and nozzle .....	0505-4
Starting aid solenoid .....	0505-3
Starting aid switch .....	0505-3
Starting aids, cold weather .....	0505-3
Starting motor, Delco-Remy .....	0422-1
Starting system .....	0422-1
Steering cylinders .....	0960-16
Steering indicator, rear .....	1676-3
Steering, manual .....	0960-7
Steering shaft and tube .....	0960-11
Steering system .....	0960-1
Steering valve .....	0960-3
Storage .....	I-IV-1
Suspension seat .....	1821-1
Switch, key .....	1676-7
Switch, neutral start .....	1674-4
Switch, reverse warning .....	1674-4
Switch, start .....	1676-7
Switch, starting aid .....	0505-3
Switch, transmission filter restriction .....	0360-15
System testing .....	9005-1

**T**

Tandem housing .....	0201-5
Tandem pivot housing .....	0201-6
Tank, fuel .....	0560-2
Teeth and shanks, Ripper .....	4201-4
Teeth and shanks, scarifier .....	4201-3
Thermostats, housings and piping .....	0418-1
Timing gear cover .....	0402-2
Timing gear train .....	0402-8
Tools, ground conditioning .....	4201-1
Transfer drive .....	0841-1
Transfer drive housing and covers .....	0841-3
Transmission case and covers .....	0341-4
Transmission clutch elements .....	0370-4
Transmission clutch housing .....	0341-1
Transmission clutch linkage .....	0370-1
Transmission clutch pedal valve .....	0360-8
Transmission clutch pedal valve linkage .....	0315-3
Transmission clutch shaft and carrier assembly .....	0370-3
Transmission clutch valve linkage .....	0315-3
Transmission control valve assembly .....	0360-4
Transmission controls .....	0315-3
Transmission direction selector lever and linkage .....	0315-5
Transmission disconnect and controls .....	0370-1
Transmission filter restriction indicator light .....	1676-5
Transmission filter restriction switch .....	0360-15
Transmission forward and reverse modulator .....	0360-12
Transmission gears, shafts, bearings and power shift clutch .....	0350-1
Transmission housings and covers .....	0341-1
Transmission hydraulics .....	0360-1
Transmission oil filter assembly .....	0360-14
Transmission oil pressure gauge .....	1676-3
Transmission oil pressure regulating valve .....	0360-10
Transmission oil pump .....	0360-1

Transmission oil temperature gauge .....	1676-6
Transmission shift lever and linkage .....	0315-7
Turbocharger .....	0416-1
Turn indicator lights .....	1676-4

**U**

Upper and lower idler gear assembly .....	0851-5
-------------------------------------------	--------

**V**

Valve and pin, lift arm locking .....	3460-9
Valve, brake .....	1060-1
Valve, bypass .....	2160-19
Valve, crossover relief .....	3460-8
Valve, differential lock .....	0210-14
Valve, engine oil pressure regulating .....	0407-3
Valve lift check .....	0402-1
Valve, pressure control .....	2160-16
Valve, rear steer .....	0960-12
Valve, ripper .....	4260-5
Valve, scarifier .....	4260-1
Valve, steering .....	0960-3
Valve, wheel lean .....	0960-13
Valves, function control .....	3460-1
Vehicle hydraulics .....	2199-9
Ventilating system .....	0408-1
Vibration damper .....	0401-3

**W**

Water pump .....	0417-1
Wheel axle assemblies .....	0250-4
Wheel axle housing .....	0201-4
Wheel lean cylinder .....	0960-20
Wheel lean valve .....	0960-13
Wheels, non-powered .....	0120-1
Wheels, powered .....	0110-3
Windshield wiper, front .....	1810-10
Wiper, rear .....	1810-9
Wiring harness .....	4670-4
Wiring harness and switches .....	1674-1

## PAGE LIST

The following list contains all page numbers with latest date lines for this technical manual. If a page does not have the date line indicated, the page is obsolete.

I-I-1, 2	(Nov-79)	2-0210-5, 6	(Nov-79)	3-0360-9, 10	(Nov-79)
I-I-3, 4	(Aug-76)	2-0210-7, 8	(Nov-79)	3-0360-11, 12	(Aug-75)
I-I-5, 6	(Aug-76)	2-0210-9, 10	(Nov-79)	3-0360-13, 14	(Nov-79)
I-I-7, 8	(Nov-79)	2-0210-11, 12	(Nov-79)	3-0360-15, 16	(Nov-79)
I-I-9, 10	(Mar-80)	2-0210-13, 14	(Nov-79)	3-0370-1, 2	(Nov-79)
I-I-11, 12	(Mar-80)	2-0210-15, 16	(Nov-79)	3-0370-3, 4	(Nov-79)
I-I-13, 14	(Mar-80)	2-0230-1, 2	(Nov-79)	3-0370-5, 6	(Nov-79)
I-I-15, 16	(Mar-80)	2-0230-3, 4	(Nov-79)	3-0399-1, 2	(Nov-79)
I-I-17, 18	(Mar-80)	2-0230-5, 6	(Nov-79)	3-0399-3, 4	(Nov-79)
I-II-1, 2	(Nov-79)	2-0230-7, 8	(Nov-79)	3-0399-5, 6	(Mar-80)
I-II-3, 4	(Nov-79)	2-0230-9, 10	(Nov-79)	3-0399-7, 8	(Nov-79)
I-III-1, 2	(Nov-79)	2-0250-1, 2	(Nov-79)	3-0399-9, 10	(Nov-79)
I-III-3, 4	(Nov-79)	2-0250-3, 4	(Nov-79)	3-0399-11, 12	(Nov-79)
I-IV-1, 2	(Nov-79)	2-0250-5, 6	(Nov-79)	3-0399-13, 14	(Mar-80)
I-IV-3, 4	(Nov-79)	2-0250-7, 8	(Nov-79)		
I-IV-5, 6	(Nov-79)	2-0250-9, 10	(Nov-79)	4-0400-1, 2	(Mar-80)
I-IV-7, 8	(Jan-77)	2-0299-1, 2	(Nov-79)	4-0400-3, 4	(Mar-80)
I-IV-9, 10	(Jan-77)	2-0299-3, 4	(Nov-79)	4-0400-5, 6	(Nov-79)
I-IV-11, 12	(Nov-79)	2-0299-5, 6	(Nov-79)	4-0401-1, 2	(Nov-79)
I-IV-13, 14	(Jan-77)	2-0299-7, 8	(Nov-79)	4-0401-3, 4	(Mar-80)
I-IV-15, 16	(Nov-79)	2-0299-9, 10	(Nov-79)	4-0401-5, 6	(Nov-79)
I-IV-17, 18	(Nov-79)			4-0402-1, 2	(Nov-79)
I-IV-19, 20	(Nov-79)	3-0315-1, 2	(Mar-80)	4-0402-3, 4	(Nov-79)
I-IV-21, 22	(Nov-79)	3-0315-3, 4	(Mar-80)	4-0402-5, 6	(Nov-79)
I-IV-23, 24	(Nov-79)	3-0315-5, 6	(Mar-80)	4-0402-7, 8	(Nov-79)
I-IV-25, 26	(Nov-79)	3-0315-7, 8	(Mar-80)	4-0402-9, 10	(Nov-79)
I-IV-27, 28	(Nov-79)	3-0341-1, 2	(Nov-79)	4-0402-11, 12	(Nov-79)
I-IV-29, 30	(Nov-79)	3-0341-3, 4	(Nov-79)	4-0402-13, 14	(Nov-79)
I-IV-31, 32	(Nov-79)	3-0341-5, 6	(Nov-79)	4-0402-15, 16	(Nov-79)
I-IV-33, 34	(Nov-79)	3-0341-7, 8	(Nov-79)	4-0402-17, 18	(Nov-79)
I-V-1, 2	(Nov-79)	3-0350-1, 2	(Nov-79)	4-0403-1, 2	(Mar-80)
		3-0350-3, 4	(Nov-79)	4-0403-3, 4	(Mar-80)
		3-0350-5, 6	(Nov-79)	4-0403-5, 6	(Mar-80)
1-0110-1, 2	(Nov-79)	3-0350-7, 8	(Mar-80)	4-0404-1, 2	(Nov-79)
1-0110-3, 4	(Nov-79)	3-0350-9, 10	(Nov-79)	4-0404-3, 4	(Nov-79)
1-0120-1, 2	(Nov-79)	3-0350-11, 12	(Mar-80)	4-0407-1, 2	(Nov-79)
1-0199-1, 2	(Nov-79)	3-0350-13, 14	(Mar-80)	4-0407-3, 4	(Mar-80)
		3-0350-15, 16	(Mar-80)	4-0408-1, 2	(Aug-75)
2-0201-1, 2	(Nov-79)	3-0350-17, 18	(Nov-79)	4-0409-1, 2	(Aug-75)
2-0201-3, 4	(Nov-79)	3-0350-19, 20	(Nov-79)	4-0409-3, 4	(Mar-80)
2-0201-5, 6	(Nov-79)	3-0350-21, 22	(Nov-79)	4-0409-5, 6	(Nov-79)
2-0201-7, 8	(Nov-79)	3-0350-23, 24	(Nov-79)	4-0410-1, 2	(Mar-80)
2-0201-9, 10	(Nov-79)	3-0350-25, 26	(Nov-79)	4-0413-1, 2	(Nov-79)
2-0201-11, 12	(Nov-79)	3-0360-1, 2	(Nov-79)	4-0413-3, 4	(Mar-80)
2-0201-13, 14	(Nov-79)	3-0360-3, 4	(Nov-79)	4-0413-5, 6	(Nov-79)
2-0201-15, 16	(Nov-79)	3-0360-5, 6	(Nov-79)	4-0413-7, 8	(Nov-79)
		3-0360-7, 8	(Aug-75)	4-0414-1, 2	(Nov-79)
2-0210-1, 2	(Nov-79)				
2-0210-3, 4	(Nov-79)				

Vertical lines indicate pages included in this revision.

PAGE LIST—Continued

4-0416-1, 2	(Aug-75)	5-0520-1, 2	(Aug-75)	16-1671-1, 2	(Nov-79)
4-0416-3, 4	(Aug-75)	5-0560-1, 2	(Aug-75)	16-1671-3, 4	(Nov-79)
4-0416-5, 6	(Nov-79)	5-0560-3, 4	(Nov-79)	16-1671-5, 6	(Nov-79)
4-0416-7, 8	(Aug-75)	5-0599-1, 2	(Nov-79)	16-1671-7, 8	(Nov-79)
4-0417-1, 2	(Nov-79)			16-1672-1, 2	(Aug-75)
4-0418-1, 2	(Mar-80)	8-0841-1, 2	(Nov-79)	16-1672-3, 4	(Nov-79)
4-0419-1, 2	(Aug-75)	8-0841-3, 4	(Mar-80)	16-1672-5, 6	(Aug-75)
4-0420-1, 2	(Aug-75)	8-0841-5, 6	(Mar-80)	16-1672-7, 8	(Nov-79)
4-0421-1, 2	(Aug-75)	8-0851-1, 2	(Nov-79)	16-1672-9, 10	(Nov-79)
4-0422-1, 2	(Aug-75)	8-0851-3, 4	(Nov-79)	16-1672-11, 12	(Nov-79)
4-0422-3, 4	(Aug-75)	8-0851-5, 6	(Nov-79)	16-1672-13, 14	(Aug-75)
4-0422-5, 6	(Aug-75)	8-0851-7, 8	(Nov-79)	16-1673-1, 2	(Aug-75)
4-0422-7, 8	(Nov-79)	8-0851-9, 10	(Nov-79)	16-1673-3, 4	(Nov-79)
4-0422-9, 10	(Aug-75)	8-0899-1, 2	(Nov-79)	16-1674-1, 2	(Nov-79)
4-0422-11, 12	(Nov-79)	8-0899-3, 4	(Nov-79)	16-1674-3, 4	(Nov-79)
4-0422-13, 14	(Nov-79)			16-1675-1, 2	(Aug-75)
4-0422-15, 16	(Nov-79)	9-0960-1, 2	(Aug-75)	16-1676-1, 2	(Nov-79)
4-0422-17, 18	(Nov-79)	9-0960-3, 4	(Aug-75)	16-1676-3, 4	(Nov-79)
4-0422-19, 20	(Nov-79)	9-0960-5, 6	(Aug-75)	16-1676-5, 6	(Nov-79)
4-0433-1, 2	(Nov-79)	9-0960-7, 8	(Nov-79)	16-1676-7, 8	(Nov-79)
4-0499-1, 2	(Mar-80)	9-0960-9, 10	(Nov-79)	16-1699-1, 2	(Aug-75)
4-0499-3, 4	(Aug-75)	9-0960-11, 12	(Nov-79)	16-1699-3, 4	(Nov-79)
4-0499-5, 6	(Nov-79)	9-0960-13, 14	(Nov-79)	16-1699-5, 6	(Mar-80)
4-0499-7, 8	(Mar-80)	9-0960-15, 16	(Aug-75)	16-1699-7, 8	(Mar-80)
4-0499-9, 10	(Mar-80)	9-0960-17, 18	(Aug-75)		
4-0499-11, 12	(Mar-80)	9-0960-19, 20	(Aug-75)	17-1740-1, 2	(Nov-79)
4-0499-13, 14	(Mar-80)	9-0999-1, 2	(Aug-75)	17-1740-3, 4	(Nov-79)
4-0499-15, 16	(Mar-80)	9-0999-3, 4	(Nov-79)	17-1740-5, 6	(Nov-79)
4-0499-17, 18	(Mar-80)			17-1740-7, 8	(Nov-79)
4-0499-19, 20	(Mar-80)	10-1011-1, 2	(Nov-79)	17-1746-1, 2	(Aug-75)
4-0499-21, 22	(Mar-80)	10-1011-3, 4	(Nov-79)	17-1799-1, 2	(Aug-75)
4-0499-23, 24	(Mar-80)	10-1015-1, 2	(Nov-79)		
4-0499-25, 26	(Mar-80)	10-1060-1, 2	(Aug-75)	18-1806-1, 2	(Nov-79)
4-0499-27, 28	(Mar-80)	10-1060-3, 4	(Nov-79)	18-1806-3, 4	(Nov-79)
4-0499-29, 30	(Mar-80)	10-1060-5, 6	(Aug-75)	18-1808-1, 2	(Nov-79)
4-0499-31, 32	(Mar-80)	10-1060-7, 8	(Nov-79)	18-1810-1, 2	(Nov-79)
4-0499-33, 34	(Mar-80)	10-1060-9, 10	(Nov-79)	18-1810-3, 4	(Nov-79)
4-0499-35, 36	(Mar-80)	10-1099-1, 2	(Aug-75)	18-1810-5, 6	(Nov-79)
4-0499-37, 38	(Mar-80)	10-1099-3, 4	(Nov-79)	18-1810-7, 8	(Nov-79)
4-0499-39, 40	(Mar-80)			18-1810-9, 10	(Nov-79)
4-0499-41, 42	(Mar-80)	11-1111-1, 2	(Nov-79)	18-1821-1, 2	(Aug-75)
4-0499-43, 44	(Mar-80)	11-1111-3, 4	(Nov-79)	18-1821-3, 4	(Aug-75)
4-0499-45, 46	(Mar-80)	11-1111-5, 6	(Nov-79)	18-1830-1, 2	(Nov-79)
4-0499-47, 48	(Mar-80)	11-1111-7, 8	(Nov-79)	18-1899-1, 2	(Nov-79)
4-0499-49, 50	(Mar-80)	11-1115-1, 2	(Nov-79)		
		11-1115-3, 4	(Nov-79)	19-1910-1, 2	(Aug-75)
		11-1199-1, 2	(Nov-79)	19-1910-3, 4	(Nov-79)
5-0505-1, 2	(Nov-79)			19-1910-5, 6	(Aug-75)
5-0505-3, 4	(Nov-79)			19-1921-1, 2	(Aug-75)
5-0510-1, 2	(Aug-75)	15-1511-1, 2	(Aug-75)		
5-0515-1, 2	(Nov-79)	15-1511-3, 4	(Aug-75)		
5-0515-3, 4	(Nov-79)				

Vertical lines indicate pages included in this revision.

PAGE LIST—Continued

21-2160-1, 2	(Nov-79)	42-4240-1, 2	(Aug-75)	90-9015-19, 20	(Nov-79)
21-2160-3, 4	(Nov-79)	42-4240-3, 4	(Nov-79)	90-9015-21, 22	(Nov-79)
21-2160-5, 6	(Nov-79)	42-4260-1, 2	(Nov-79)	90-9015-23, 24	(Aug-75)
21-2160-7, 8	(Nov-79)	42-4260-3, 4	(Aug-75)	90-9015-25, 26	(Nov-79)
21-2160-9, 10	(Mar-80)	42-4260-5, 6	(Aug-75)	90-9015-27, 28	(Nov-79)
21-2160-11, 12	(Mar-80)	42-4260-7, 8	(Aug-75)	90-9015-29, 30	(Nov-79)
21-2160-13, 14	(Nov-79)	42-4260-9, 10	(Aug-75)	90-9015-31, 32	(Nov-79)
21-2160-15, 16	(Mar-80)	42-4260-11, 12	(Nov-79)	90-9015-33, 34	(Nov-79)
21-2160-17, 18	(Nov-79)	42-4260-13, 14	(Nov-79)	90-9015-35, 36	(Nov-79)
21-2160-19, 20	(Nov-79)	42-4260-15, 16	(Nov-79)	90-9015-37, 38	(Nov-79)
21-2160-21, 22	(Nov-79)	42-4260-17, 18	(Nov-79)	90-9015-39, 40	(Nov-79)
21-2199-1, 2	(Aug-75)	42-4260-19, 20	(Aug-75)	90-9015-41, 42	(Nov-79)
21-2199-3, 4	(Aug-75)	42-4260-21, 22	(Nov-79)	90-9015-43, 44	(Nov-79)
21-2199-5, 6	(Mar-80)	42-4299-1, 2	(Nov-79)	90-9015-45, 46	(Nov-79)
21-2199-7, 8	(Nov-79)	42-4299-3, 4	(Nov-79)	90-9015-47, 48	(Nov-79)
21-2199-9, 10	(Mar-80)	42-4299-5, 6	(Nov-79)	90-9015-49, 50	(Nov-79)
21-2199-11, 12	(Mar-80)	46-4615-1, 2	(Nov-79)	90-9015-51, 52	(Nov-79)
		46-4615-3, 4	(Aug-76)	90-9015-53, 54	(Nov-79)
34-3401-1, 2	(Nov-79)	46-4615-5, 6	(Nov-79)	90-9020-1, 2	(Nov-79)
34-3401-3, 4	(Nov-79)	46-4615-7, 8	(Aug-76)	90-9020-3, 4	(Aug-75)
34-3401-5, 6	(Nov-79)	46-4615-9, 10	(Nov-79)	90-9020-5, 6	(Aug-75)
34-3415-1, 2	(Aug-75)	46-4615-11, 12	(Nov-79)	90-9020-7, 8	(Nov-79)
34-3415-3, 4	(Aug-75)	46-4615-13, 14	(Nov-79)	90-9020-9, 10	(Nov-79)
34-3415-5, 6	(Aug-75)	46-4640-1, 2	(Aug-76)	90-9020-11, 12	(Nov-79)
34-3440-1, 2	(Nov-79)	46-4660-1, 2	(Aug-76)	90-9020-13, 14	(Nov-79)
34-3440-3, 4	(Nov-79)	46-4660-3, 4	(Nov-79)	90-9020-15, 16	(Nov-79)
34-3440-5, 6	(Nov-79)	46-4660-5, 6	(Nov-79)	90-9025-1, 2	(Nov-79)
34-3440-7, 8	(Nov-79)	46-4660-7, 8	(Nov-79)	90-9025-3, 4	(Nov-79)
34-3450-1, 2	(Nov-79)	46-4670-1, 2	(Nov-79)	90-9025-5, 6	(Nov-79)
34-3460-1, 2	(Aug-75)	46-4670-3, 4	(Nov-79)	90-9025-7, 8	(Aug-75)
34-3460-3, 4	(Nov-79)	46-4699-1, 2	(Aug-76)	90-9025-9, 10	(Aug-75)
34-3460-5, 6	(Aug-75)			90-9025-11, 12	(Aug-75)
34-3460-7, 8	(Nov-79)	90-9005-1, 2	(Aug-75)	90-9025-13, 14	(Aug-75)
34-3460-9, 10	(Nov-79)	90-9005-3, 4	(Aug-75)	90-9025-15, 16	(Aug-75)
34-3460-11, 12	(Nov-79)	90-9010-1, 2	(Aug-75)	90-9025-17, 18	(Nov-79)
34-3460-13, 14	(Nov-79)	90-9010-3, 4	(Aug-75)	90-9025-19, 20	(Nov-79)
34-3460-15, 16	(Nov-79)	90-9010-5, 6	(Aug-75)	90-9025-21, 22	(Nov-79)
34-3460-17, 18	(Nov-79)	90-9010-7, 8	(Aug-75)	90-9025-23, 24	(Aug-75)
34-3460-19, 20	(Nov-79)	90-9010-9, 10	(Nov-79)	90-9025-25, 26	(Aug-75)
34-3460-21, 22	(Nov-79)	90-9010-11, 12	(Nov-79)	90-9025-27, 28	(Aug-75)
34-3460-23, 24	(Nov-79)	90-9010-13, 14	(Mar-80)	90-9025-29, 30	(Aug-75)
34-3460-25, 26	(Nov-79)	90-9010-15, 16	(Mar-80)	90-9025-31, 32	(Nov-79)
34-3460-27, 28	(Nov-79)	90-9015-1, 2	(Nov-79)	90-9025-33, 34	(Nov-79)
34-3499-1, 2	(Nov-79)	90-9015-3, 4	(Aug-75)	90-9025-35, 36	(Nov-79)
34-3499-3, 4	(Aug-75)	90-9015-5, 6	(Nov-79)	90-9025-37, 38	(Nov-79)
34-3499-5, 6	(Aug-75)	90-9015-7, 8	(Nov-79)	90-9025-39, 40	(Aug-75)
34-3499-7, 8	(Aug-75)	90-9015-9, 10	(Aug-75)	90-9025-41, 42	(Nov-79)
		90-9015-11, 12	(Nov-79)	90-9025-43, 44	(Nov-79)
42-4201-1, 2	(Aug-75)	90-9015-13, 14	(Nov-79)	90-9025-45, 46	(Nov-79)
42-4201-3, 4	(Nov-79)	90-9015-15, 16	(Nov-79)	90-9025-47, 48	(Nov-79)
42-4215-1, 2	(Nov-79)	90-9015-17, 18	(Nov-79)	90-9025-49, 50	(Mar-80)

Vertical lines indicate pages included in this revision.

PAGE LIST—Continued

90-9025-51, 52	(Mar-80)
90-9025-53, 54	(Mar-80)
90-9025-55, 56	(Mar-80)
90-9025-57, 58	(Mar-80)
90-9025-59, 60	(Mar-80)
90-9025-61, 62	(Mar-80)
90-9025-63, 64	(Mar-80)
90-9025-65, 66	(Mar-80)
90-9030-1, 2	(Nov-79)
90-9030-3, 4	(Nov-79)
90-9030-5, 6	(Nov-79)
90-9032-1, 2	(Nov-79)
90-9032-3, 4	(Nov-79)
90-9032-5, 6	(Nov-79)
90-9032-7, 8	(Nov-79)
90-9032-9, 10	(Nov-79)
90-9032-11, 12	(Nov-79)
90-9032-13, 14	(Nov-79)
90-9032-15, 16	(Nov-79)
90-9032-17, 18	(Nov-79)
90-9032-19, 20	(Nov-79)
90-9032-21, 22	(Nov-79)
90-9032-23, 24	(Nov-79)
90-9032-25, 26	(Nov-79)
90-9032-27, 28	(Nov-79)
90-9032-29, 30	(Nov-79)
90-9035-1, 2	(Mar-80)
90-9035-3, 4	(Nov-79)
90-9035-5, 6	(Nov-79)
90-9035-7, 8	(Nov-79)
90-9035-9, 10	(Nov-79)
90-9035-11, 12	(Nov-79)
90-9035-13, 14	(Nov-79)
90-9035-15, 16	(Nov-79)
90-9035-17, 18	(Nov-79)
90-9035-19, 20	(Nov-79)
90-9035-21, 22	(Nov-79)

Vertical lines indicate pages included in this revision.

## Group II INTRODUCTION AND SAFETY INFORMATION INTRODUCTION



*Use FOS Manuals for Reference*

This technical manual is part of a twin concept of service:

The two kinds of manuals work as a team to give you both the general background and technical details of shop service.

### •FOS Manuals - For Reference

Fundamentals of Service (FOS) Manuals cover basic theory of operation, fundamentals of troubleshooting, general maintenance, and basic types of failure and their causes. FOS Manuals are for training new personnel and for reference by experienced service technicians.



When a service technician should refer to a FOS Manual for more information, a FOS symbol like the one at the left is used in the TM to identify the reference.

### •Technical Manuals - For Actual Service

Technical Manuals are concise service guides for a specific machine. Technical manuals are on-the-job guides containing only the vital information needed by an experienced service technician.

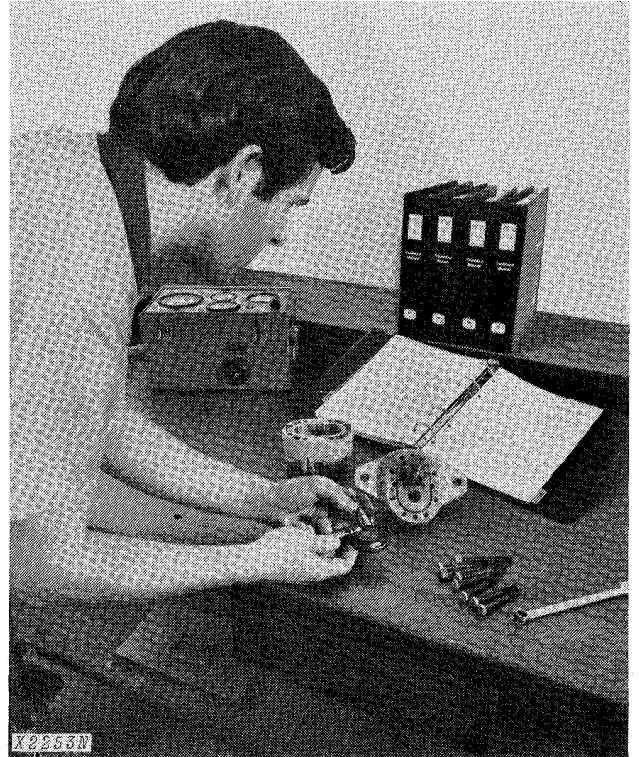

*Use Technical Manuals for Actual Service*

This technical manual was planned and written for you - an experienced service technician. Keep it in a permanent binder in the shop where it is handy. Refer to it whenever in doubt about correct service procedures or specifications.

Some features of this manual:

- Inside front cover - "Table of Contents".
- Section I - General specifications and services.
- Sections 1 through 46 - Removal, repair, testing (components removed), installation, and adjustment.
- Section 90 - Detailed explanation of system operation, diagnosis, visual inspection, testing, and adjustments.
- Specifications grouped and illustrated at the end of each section.

## MAINTENANCE WITHOUT ACCIDENT WORK SAFELY



T27999N

 This safety alert symbol identifies important safety messages in this manual and on the motor grader. When you see this symbol, be alert to the possibility of personal injury and carefully read the message that follows.

**EVERY EMPLOYER HAS A  
SAFETY PROGRAM. KNOW  
WHAT IT IS!**

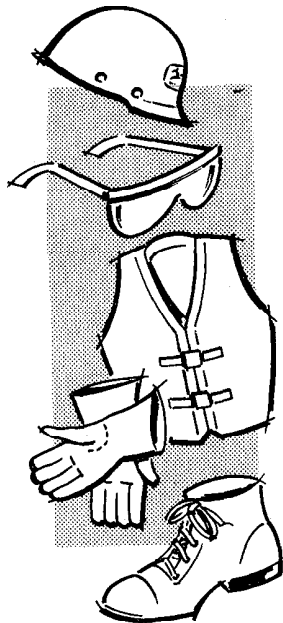

T27501

Consult your shop foreman for specific instructions on a job, and the safety equipment required.

For instance, you may need: Hard hat, safety shoes, safety goggles, heavy gloves, reflector vests, ear protectors, respirators.



T27502N

### BE ALERT!

Plan ahead—work safely—know how to use a first-aid kit and a fire extinguisher—and where to get aid and assistance.

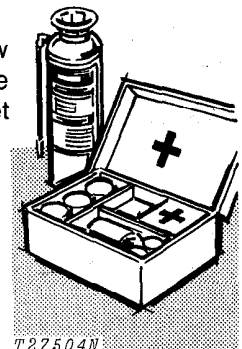

T27504N

### Maintenance Area

Make sure the maintenance area is adequately vented.

Keep maintenance area **CLEAN AND DRY**. Oily and wet floors are slippery; greasy rags are a fire hazard; wet spots are dangerous when working with electrical equipment.

Store starting aids in a cool and well-ventilated place, out of the reach of unauthorized personnel.

## MAINTENANCE WITHOUT ACCIDENT

### AVOID FIRE HAZARDS—

#### Fuel Is Dangerous!

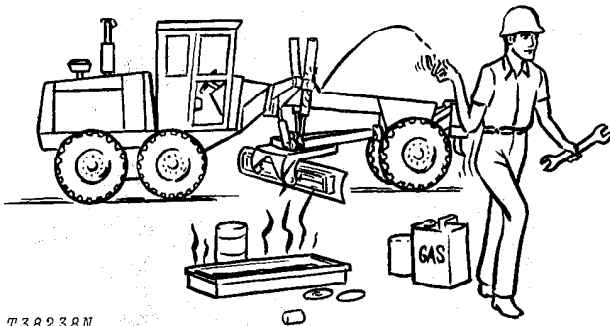

Don't smoke while refueling.

Don't smoke while handling highly flammable material.

Engine should be shut off when refueling.

Use care in refueling if the engine is hot.

Don't use open pans of gasoline or diesel fuel for cleaning parts. Good commercial, nonflammable solvents are preferred.

#### Battery Gas Is Highly Flammable!

Provide adequate ventilation when charging batteries.



Don't check battery charge by placing metal objects across the posts.

Don't allow sparks or open flame near batteries.

Don't smoke near battery.

#### Flame Is Not a Flashlight!

**NEVER USE OPEN FLAME AROUND THE MACHINE.**

**KNOW WHERE FIRE EXTINGUISHERS ARE KEPT!**

Litho in U.S.A.

### UNDER ALL MAINTENANCE CONDITIONS—

Do not perform any work on the equipment unless authorized to do so. Then be sure you know the safe and proper procedure.

Follow recommended procedures.

Never service the equipment while it is being operated.

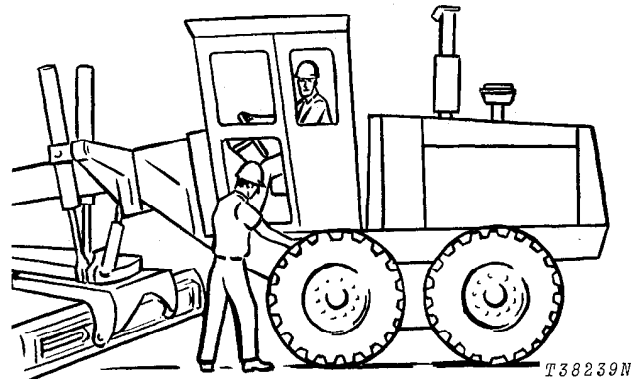

Avoid working on equipment with the engine running.

If it is necessary to make checks with the engine running, **ALWAYS USE TWO** service technicians—one, the operator, at the controls, the other checking within sight of the operator.

### KEEP HANDS AWAY FROM MOVING PARTS

Support all raised equipment.

Never work under raised blade, ripper, or scarifier.

Lower all equipment to ground.

If the machine is on an incline, block it securely.

Use hoisting equipment for lifting heavy parts.

### TAKE CARE! WATCH OUT FOR OTHER PEOPLE IN THE VICINITY

Wear safety glasses when drilling, grinding, or hammering metal.

## SERVICING PRECAUTIONS

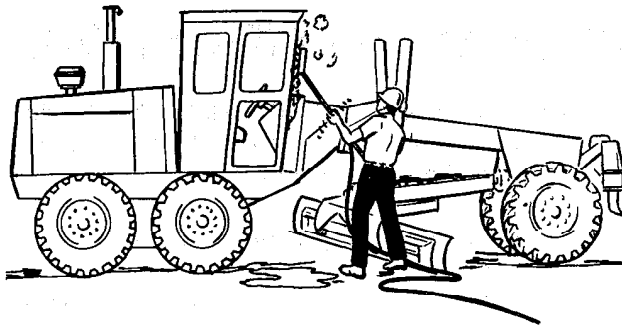

T38242N

Keep ALL equipment free of dirt and oil.

Be sure to clean any oil, grease, mud, ice, or snow from floor of operator's compartment, stepping points, and grab rails.

When preparing the engine for storage, remember that inhibitor is volatile and therefore dangerous. Seal and tape openings after adding the inhibitor. Keep container tightly closed when not in use.

Don't remove the radiator cap until coolant temperature is below the boiling point. Then turn cap slightly to relieve pressure before removing.

Periodically check exhaust system for excessive leakage.

Relieve hydraulic pressure before working on hydraulic system: shut off engine, lower all equipment to ground, and move control levers until no response is felt.

When checking hydraulic pressure, be sure to use the correct test gauge.

## PRECAUTIONS DURING REPAIR

Before working on hydraulic system relieve hydraulic pressure.

Before repairing the electrical system, or performing a major overhaul, disconnect batteries.

## KNOW EQUIPMENT IS READY!

Check guards, safety bars—all protective devices installed on the grader. Every one should be in place and secure.

## CHECK IT OUT!

- GUARDS
- SHIELDS
- PROTECTIVE DEVICES
- SEAT BELTS, ETC.

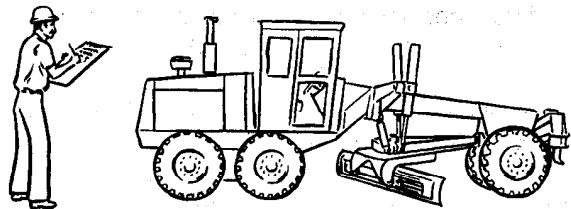

T38243N

Carefully inspect equipment for visual defects—leaks in fuel, lubrication, and hydraulic systems. Do not search for pressurized fluid leaks with your hands. Use cardboard or wood to search for leaks.

## Group III

# GENERAL SPECIFICATIONS

(Specifications and design subject to change without notice. Wherever applicable, specifications are in accordance with SAE Standards. Except where otherwise noted, these specifications are based on a unit equipped with 13.00-24, 8 ply rating, tubeless tires, 12 ft. (3.66 m) moldboard and standard equipment.)

Power @ 2300  
 engine rpm:           **SAE**  
 Gross ..... 135 (100.7 kW\*)  
 Net ..... 125 (93.2 kW\*)           126.7 PS

Net engine flywheel power is for an engine equipped with fan, air cleaner, water pump, lubricating-oil pump, fuel pump, alternator, and muffler. Gross engine power is without fan. Gross and net flywheel power ratings are under SAE standard conditions of 500 ft. (152 m) altitude and 85°F (29°C) temperature and DIN 70 020 standard conditions (non-corrected). No derating is required up to 10,000 ft. (3000 m).

\*In the international system of units (SI), power is expressed in kilowatts (kW).

Engine: John Deere turbocharged diesel, vertical 6-cylinder, valve-in-head, 4-stroke cycle.  
 Bore and stroke... 4.19 x 5 in. (106.5 x 127 mm)  
 Piston displacement ..... 414 cu. in. (6 784 cm<sup>3</sup>)  
 Compression ratio ..... 16.2 to 1  
 Maximum torque @ 1300 rpm ..... 372 lb-ft (504 Nm)  
 NACC or AMA (U.S. Tax) horsepower ..... 42.1  
 Main bearings ..... 7  
 Lubrication ..... Pressure system with full-flow filter  
 Cooling ..... Pressurized with thermostat and fixed bypass  
 Fan ..... Suction  
 Air cleaner with restriction indicator ..... Dry  
 Electrical system .... 24 volt (24 V) with alternator  
 Batteries (2) 12 volt ..... Reserve capacity: 180 minutes each  
 Transmission ..... Power Shift, 8 forward and 4 reverse selections  
 Differential Lock ..... Foot-operated, hydraulically-actuated  
 Final Drives ..... Inboard planetary

Travel Speeds (2,300 engine rpm, no tire slip):

Shift Lever Position	mph	km/h
Forward 1	2.3	3.6
2	3.2	5.1
3	4.8	7.8
4	6.3	10.1
5	8.2	13.2
6	10.5	17.0
7	14.1	22.8
8	23.9	38.4
Reverse 1	2.8	4.5
2	3.9	6.3
3	5.9	9.5
4	7.6	12.3

Brakes:

Service ..... Foot-operated, hydraulically actuated, wet-disk, effective on 4 tandem wheels  
 Parking ..... Foot-operated, mechanical, dry-disk effective on 4 tandem wheels

Steering:

Front ..... Full hydraulic power system  
 Range ..... 47.5 deg. left or right  
 Rear ..... Hydraulically-articulated frame steering (25 deg. left or right)  
 Turning radius ..... 22 ft. (6.7 m)

Hydraulic System: Closed-center

Standby pressure ..... 2,250 psi (155 bar)  
 Pump ..... Variable-displacement, 35 gpm (132 L/min.) @ 2,300 engine rpm  
 Circle: Welded angle, 4 ft. 10 in. (1.47 m) dia.  
 Rotation ..... 360 deg.  
 Drive ..... Hydraulic motor and worm gear  
 Drawbar ..... Welded box, 3.5x7x0.38 in. (89x178x10 mm) wall, with ball and socket pivot



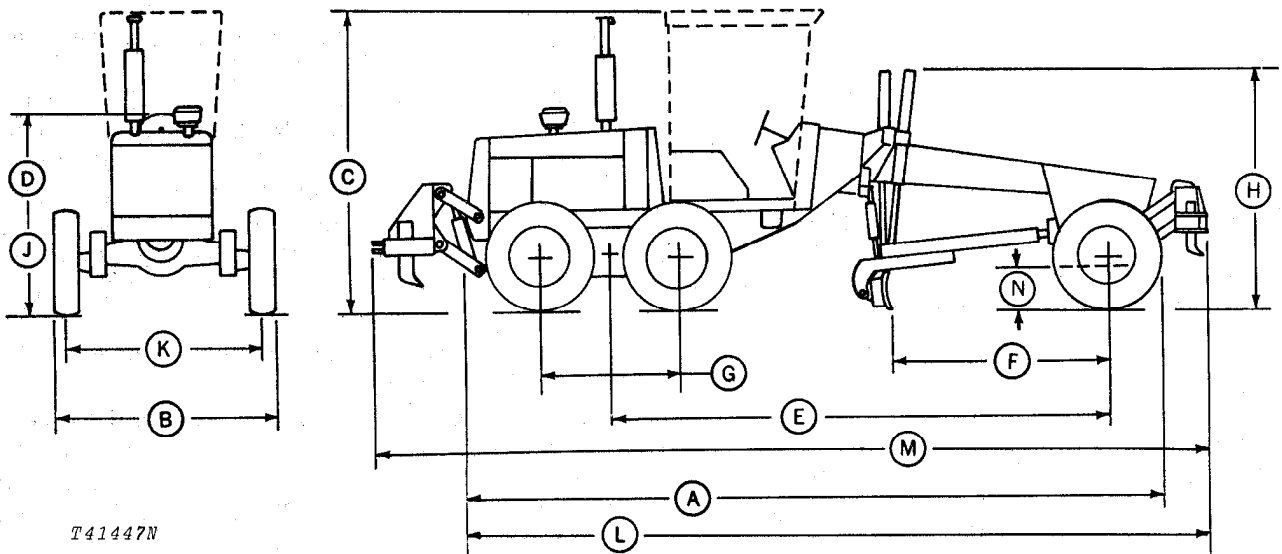

T41447N

**OVER-ALL DIMENSIONS**

- A. Length ..... 27 ft. 3.2 in. (8.31 m)
- B. Width (13.00 - 24 tires)  
 (Front and rear) ..... 7 ft. 10 in. (2.34 m)  
 Width (17.5 - 25 tires)  
 (Front and rear) ..... 8 ft. 6 in. (2.59 m)  
 Width (14.00 - 24 tires)  
 (Front and rear) ..... 8 ft. (2.44 m)
- C. Height (with Cab) ..... 10 ft. 6 in. (3.2 m)
- D. Height (without Cab - To  
 Top of Steering Wheel) .... 88.4 in. (2.24 m)
- E. Wheelbase ..... 19 ft. 7 in. (5.97 m)
- F. Blade base ..... 8 ft. 4 in. (2.54 m)
- G. Tandems (Center Line) .. 5 ft. 0.71 in. (1.54 m)
- H. Height (Top Lift Cylinders) .. 8 ft. 9.3 in. (2.67 m)
- J. Height (Top Pre-Cleaner) .... 93.75 in. (2.38 m)

**Additional Standard Equipment:**

- |                                                |                             |
|------------------------------------------------|-----------------------------|
| Transistorized voltage regulator               | Gauges:                     |
| Lights (2 white front with stop and taillight) | Transmission pressure       |
| Mechanical hour meter                          | Water temperature           |
| Cigar lighter                                  | Transmission temperature    |
| Horn                                           | Engine oil pressure         |
| Deluxe seat                                    | Transmission lube           |
| Front windshield wiper                         | Fuel                        |
| Rear windshield wiper                          | Pre-cleaner                 |
| Work lights (2 front and 2 rear floods)        | ROPS with cab and seat belt |
| Turn signals                                   | 12 ft. (3.66 m) moldboard   |
| Cold weather starting aid                      | Engine side shields         |
| Vandal protection                              | Air filter indicator        |
|                                                | Floor mat                   |

**OVER-ALL DIMENSIONS**

- K. Tread  
 (Front) (13.00 - 24 tires) ... 76.6 in. (1.94 m)  
 (Front) (17.5 - 25 tires) ... 79.36 in. (2.01 m)  
 (Front) (14.00 - 24 tires) ... 76.6 in. (1.94 m)  
 (Rear) (13.00 - 24 tires) .. 79.61 in. (2.02 m)  
 (Rear) (17.5 - 25 tires) ... 82.37 in. (2.09 m)  
 (Rear) (14.00 - 24 tires) .. 79.61 in. (2.02 m)
- L. Length with Scarifier (In Up Position) ..... 29 ft. 2.6 in. (8.9 m)
- M. Length of Scarifier and Ripper (both in up position) ..... 31 ft. 8.2 in. (9.66 m)
- N. Front axle ground clearance  
 with 13.00 - 24 tires ..... 22 in. (559 mm)  
 with 17.5 - 25 tires ..... 23.2 in. (589 mm)  
 with 14.00 - 24 tires ..... 22.5 in. (571 mm)

- |                                        |                                                |
|----------------------------------------|------------------------------------------------|
| Special Equipment:                     | Coolant heater                                 |
| Scarifier                              | Bench seat                                     |
| Cab heater                             | 2 ft. (610 mm)                                 |
| Cab defroster fan                      | moldboard extensions, right or left            |
| ROPS with canopy and seat belt         | Engine disconnect                              |
| Rear-mounted ripper with drawbar hitch | Overlay end bits                               |
| Below-cab blade lights (2)             | Transmission bottom guard                      |
| Reverse warning alarm                  | Drawbar hitch                                  |
| Tool box                               | 3 in. (76 mm) seat belt                        |
| Sound baffles for engine side shields  | 13 ft. (3.96 m) and 14 ft. (4.27 m) moldboards |
| Heavy-duty cutting edges               | Articulation indicator                         |



## Group IV PREDELIVERY, DELIVERY, AND AFTER-SALE SERVICES

### TEMPORARY UNIT STORAGE

After receiving your unit from the factory and before putting the machine into temporary storage, perform the following checks.

For long term storage (over 30 days) information, consult your JD670 operator's manual.

1. Check battery electrolyte level and charge the battery, if necessary.
2. Check the level of coolant in the radiator. The coolant should be maintained at a level 4 inches (102 mm) below the top of the filler neck.
3. Fill the fuel tank.
4. Check crankcase oil level. Oil should be above bottom mark of dipstick after machine has been shut down for 10 minutes.
5. Relieve hydraulic pressure by stopping engine, lowering blade and operating control levers until system fails to respond.
6. Reduce shipping pressure of all tires to inflation pressure shown on page I-IV-10.
7. Cover unit for protection and cleanliness.

### PREDELIVERY SERVICE

Because of the shipping factors involved, plus extra finishing touches that are necessary to promote customer satisfaction, proper predelivery service is of prime importance to the dealer and the customer.

Use the following list when preparing a motor grader for delivery to the customer.

### 1. Pre-Cleaner

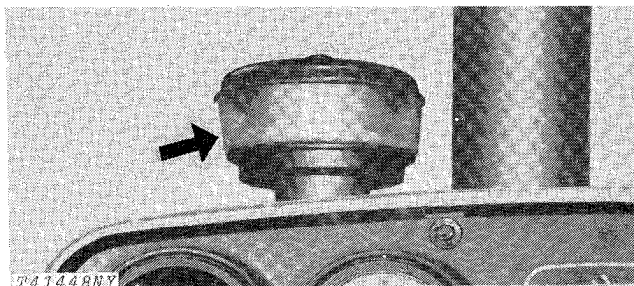

Fig. 1-Pre-Cleaner

Check pre-cleaner bowl. Clean it, if necessary.

Pre-cleaner checked and cleaned

Yes No

### 2. Air Cleaner

Check air cleaner restriction indicator on instrument on instrument panel. If indicator shows red, check and clean the primary element. Install new primary and safety elements, if necessary.

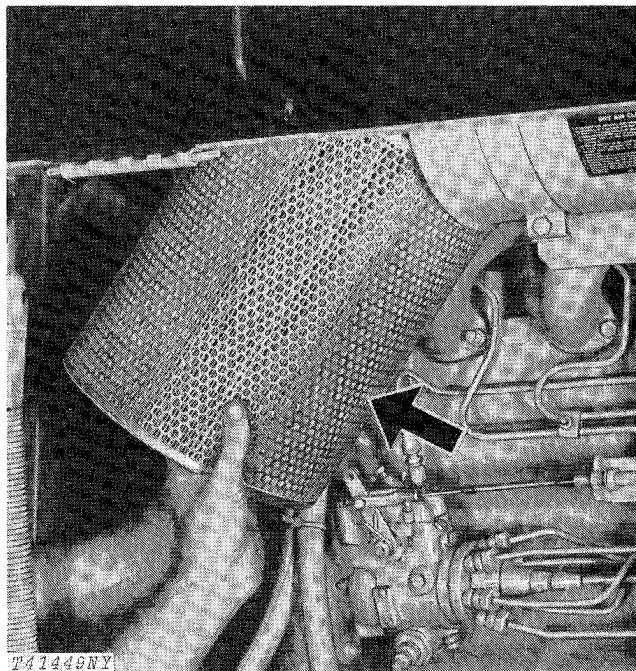

Fig. 2-Primary Element

Air cleaner checked

New elements installed

Yes No

### 3. Fuel Filter

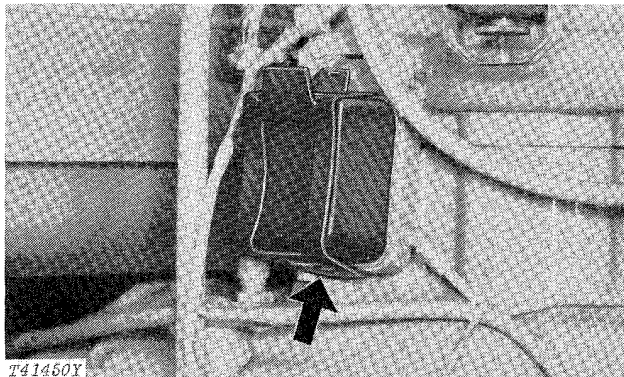

Fig. 3-Fuel Filter

Check fuel filter for sediment. Drain if necessary.

Sediment present in filter Yes No

### 4. Batteries

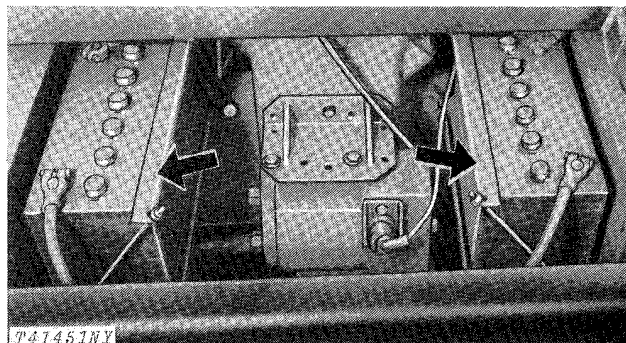

Fig. 4-Batteries

Check battery electrolyte level. If distilled water is not available, use clean soft water. Avoid use of hard water. Remove foreign material from top of battery and coat terminals with petroleum jelly. Clean vent holes in battery caps.

**IMPORTANT: Never add water to battery in freezing weather unless engine will be run 2 or 3 hours.**

Check battery connection.  
 Punch date code on battery.

Battery connections checked Yes No  
 Water added Yes No

### 5. Fuel Tank

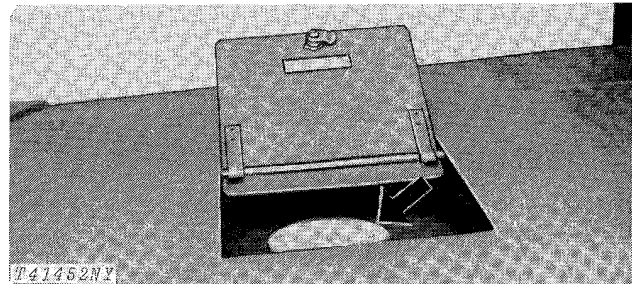
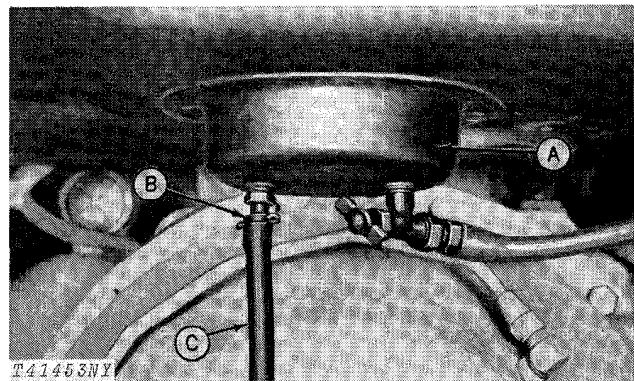

Fig. 5-Fuel Tank Filler Cap

Fill the fuel tank. Check fuel gauge. Fuel tank capacity is 60 U.S. gal (227 L).

Fuel tank filled Yes No  
 Fuel gauge checked Yes No

### 6. Fuel Tank Sump



A—Fuel Tank Sump  
 B—Sump Drain

C—Plastic Hose

Fig. 6-Fuel Tank Sump

**IMPORTANT: Sediment and water will settle over extended periods of transport or storage.**

Open fuel tank drain cock. Allow fuel to drain for several seconds.

Fuel sump drained Yes No

## 7. Radiator

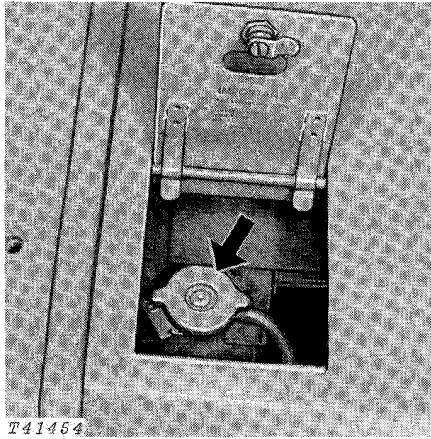

Fig. 7-Radiator Filler Cap

**CAUTION:** Remove radiator filler cap only when coolant temperature is below boiling point. Then loosen cap slightly to the stop to relieve pressure before removing the cap completely.

Check coolant level in radiator. Coolant must be 4 inches (102 mm) below the top of the filler neck. Add permanent-type antifreeze if cold weather is expected.

Radiator coolant level checked	Yes	No
Coolant or antifreeze added	_____	_____ qts. (L)

## 8. Tandem Drives

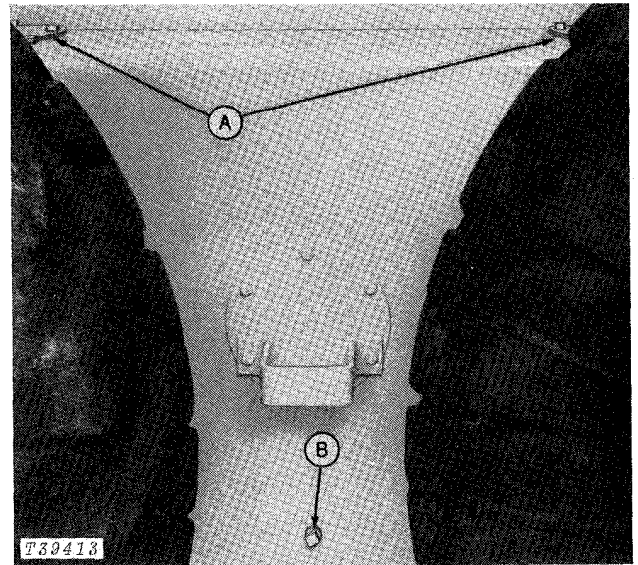

A—Inspection Plates

B—Oil Level Plug

Fig. 8-Tandem Drive

Park grader on level surface. Check oil in both tandems by removing oil level plug. Oil must be level with check plug hole. If necessary, add oil specified on page I-V-2 through one of the holes under inspection plates.

Tandem drives oil level checked	Yes	No
Oil added	_____	_____ qts. (L)

### 9. Crankcase Oil Level

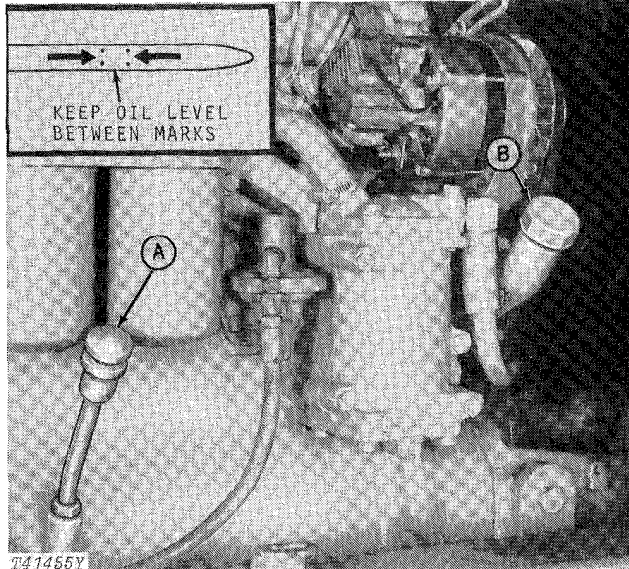

A—Dipstick B—Oil Filler Cap

Fig. 9-Crankcase Oil Level

Check crankcase oil level with machine on level ground and engine off. If oil level is at or below bottom mark on dipstick, add oil specified on page I-V-2 to bring oil level to between marks on dipstick. Do not operate engine with oil level below the bottom mark.

**NOTE:** There is a 2-quart (1.9 L) difference between the bottom mark and the top mark on the dipstick.

Crankcase oil level checked Yes No  
 Oil added \_\_\_\_\_qts. (L)

### 10. Circle Drive Gear Box

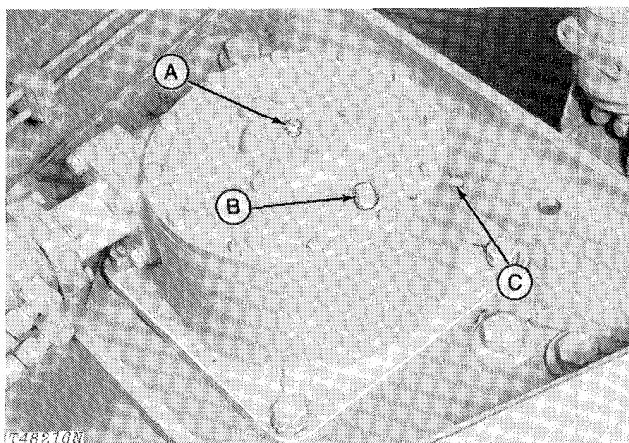

A—Vent B—Filler Plug C—Oil Level Plug

Fig. 10-Circle Drive Gear Box

With the draft frame level and blade on ground, check the circle drive gearbox oil level by removing the oil level plug. Oil must be level with the plug hole. If necessary, add oil specified on page I-V-2 through filler plug hole. Install plug.

Circle drive gear box oil level checked Yes No  
 Oil added \_\_\_\_\_qts. (L)

### 11. Alternator-Fan Belt Tension

Check belt tension.

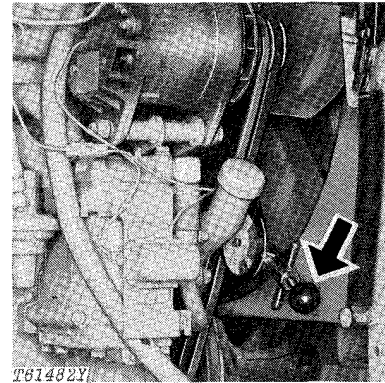

Fig. 11-Tension Gauge

Tension gauge: Immediately after engine shut down (run engine at least 5 minutes), check belt tension on front belt only. If less than 50 lb. (223 N), allow engine to cool 10 to 15 minutes, then reset tension to 90 lb. (400 N).

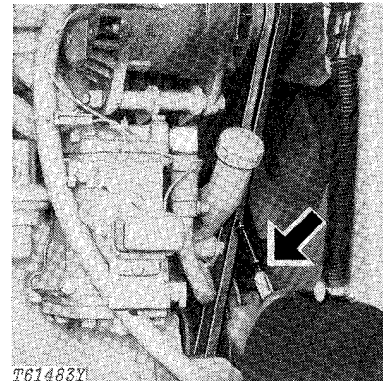

Fig. 12-Tension Tester

Tension tester: Apply 24 lb. (107 N) force midway between pulleys. Belt must deflect 1/2 in. (13 mm).

If adjustment is needed, see page I-IV-24.

Belt tension checked Yes No

## 12. Air Intake Hoses

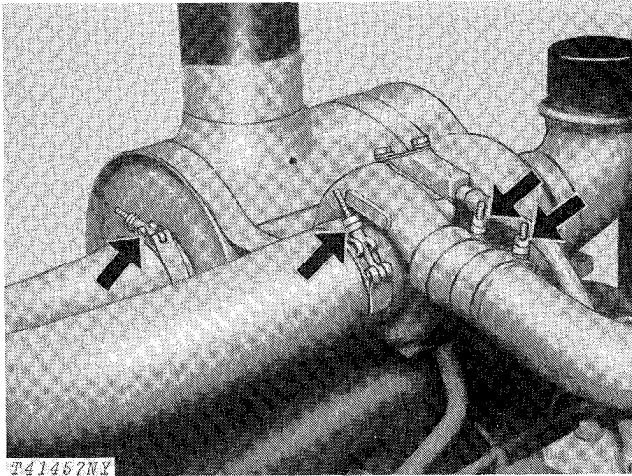

Fig. 13-Air Intake Hose Clamps

Check clamps on hoses which connect air cleaner and turbocharger tube and air intake manifold and turbocharger tube. Tighten hose clamps where necessary to prevent dirt from entering engine. Inspect hoses for cracks.

Air intake hoses checked	Yes	No
Loose connections	Yes	No

## 13. Transmission-Hydraulic System Oil Level

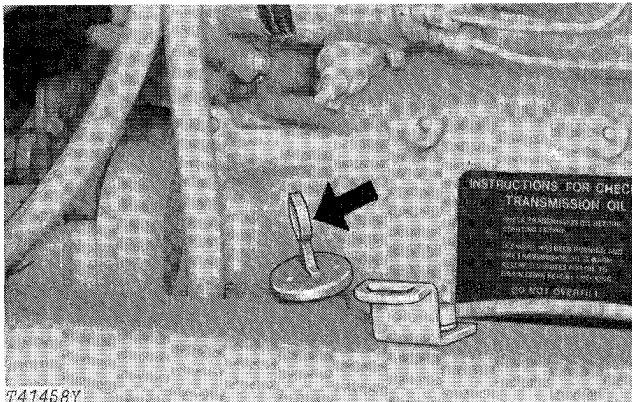

Fig. 14-Transmission-Hydraulic System Filler Cap and Dipstick

Check the transmission-hydraulic system oil level with the dipstick fully inserted in dipstick tube.

Perform the following transmission-hydraulic oil level check: Before starting the engine check the oil level with dipstick. If the oil level is at or near the upper mark, there is sufficient oil in the system to permit starting the engine. If oil level is low, add oil specified on page I-V-2. Install dipstick.

If the engine has been running and the transmission oil is warm, allow 10 minutes for oil to drain down before checking.

Transmission-hydraulic oil level checked	Yes	No
Oil added	_____	qts. (L)

## 14. Engine Speeds

Warm up engine. Remove hour meter and attach tachometer in hour meter drive plug hole to check engine speeds.

No-load, fast idle speed must be 2425-2475 rpm. Slow idle must be 875-925 rpm.

If engine speeds need adjustment, see page I-IV-24.

### 15. Parking Brake

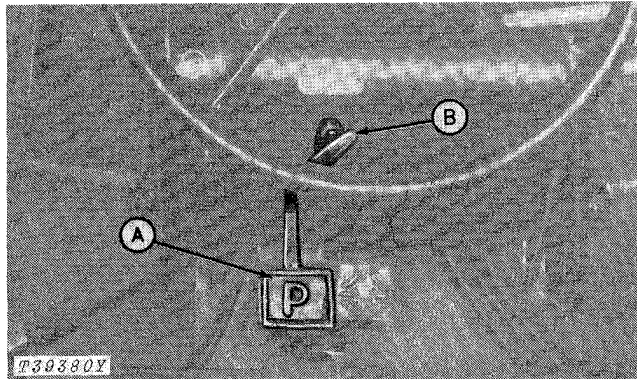

A—Engage Pedal                      B—Disengage Handle

Fig. 15—Parking Brake

Depress parking brake. When pedal uses over 3/4 total travel to fully apply the brake, adjust the brake. See page I-IV-26.

To release the parking brake, pull handle B, while holding down pedal A to take the load off latch.

Parking brake checked                      Yes    No

### 16. Seat

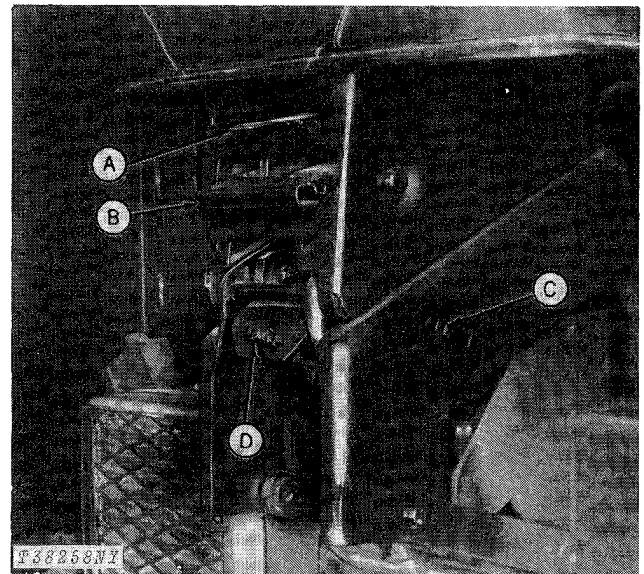

A—Seat Position Selector              C—Indicator  
 Lever                                      D—Weight Adjusting  
 B—Seat Release Catch                Screw

Fig. 16—Seat Operation

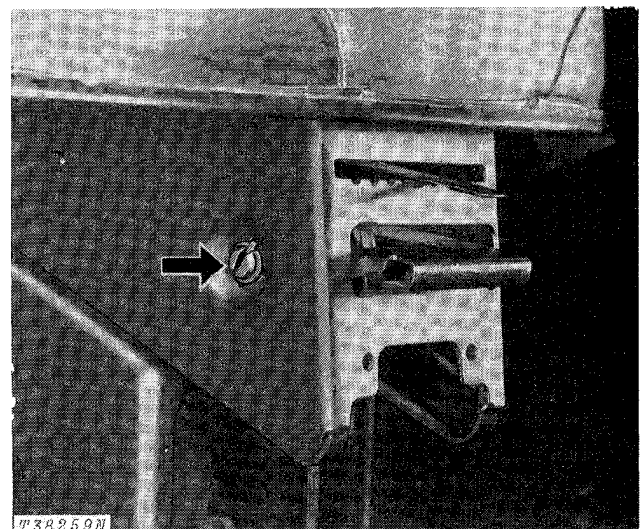

Fig. 17—Seat Counterbalance Shaft

Check seat adjusting mechanisms in Figs. 16 and 17 for easy and correct action.

Seat operation checked                      Yes    No

## 17. Reverser Operation

The reverser unit allows the operator to change the direction of travel "on the go" without declutching or shifting gears.

When the direction selector lever is moved forward from neutral, the motor grader will move forward if the transmission speed selector lever is positioned in gear.

When the direction selector lever is moved rearward from neutral, the motor grader will move rearward if the transmission speed selector lever is in the 1-4 gear range. If the transmission speed selector lever is in the 5-8 gear range, the direction selector cannot be moved rearward.

Direction selector lever checked

Yes No

## 18. Indicator Lights and Gauges

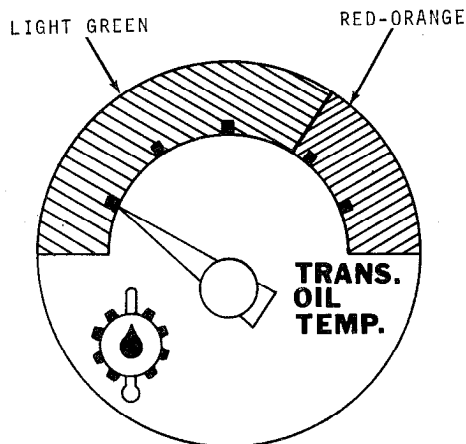

T38261N

Fig. 18-Transmission Oil Temperature Gauge

The transmission oil temperature gauge indicates the temperature of the lubricating oil in the transmission. If indicator hand enters the red-orange zone, operate in a lower gear or speed. If hand remains in the red-orange zone, check transmission oil level or plugged oil cooler. Do not continue grader operation with hand in the red-orange zone.

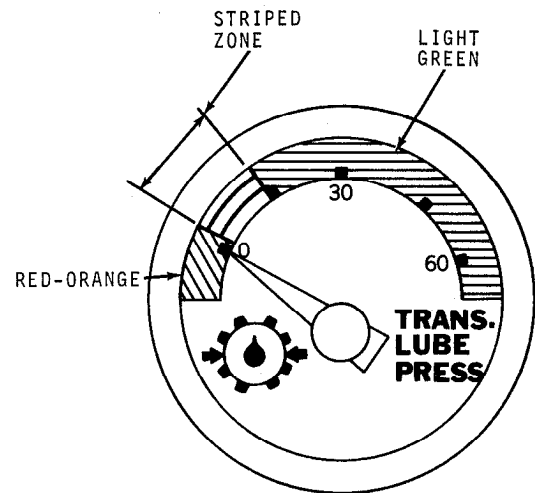

T38262N

Fig. 19-Transmission Lube Pressure Gauge

During normal operations, the indicator hand on the transmission lube pressure gauge should be in the light green zone on the dial. When the transmission oil temperature gauge is indicating near the top of the light green zone, the indicator hand on the transmission lube pressure gauge may indicate near the bottom of its light green zone. When the engine is idling the indicator hand should be in the striped zone.

**IMPORTANT: Do not operate the grader if the indicator falls into the red-orange zone.**

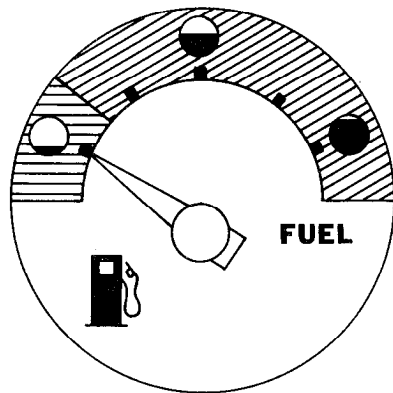

T38264N

Fig. 20-Fuel Gauge

The fuel gauge is used to determine the amount of fuel in the fuel tank.

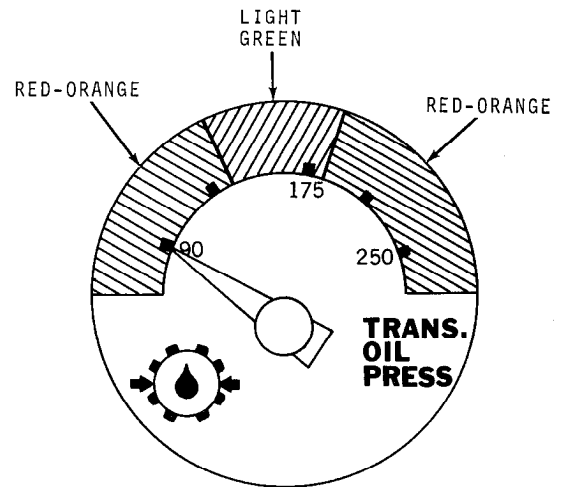

T38263N

Fig. 22-Transmission Oil Pressure Gauge

During normal operations, the indicator hand on the transmission oil pressure gauge should be in the light green zone on the dial. If the indicator hand is in the right-hand red-orange zone, there is excess pressure in the transmission. If the indicator hand drops into the left red-orange zone, there is low pressure. If hand is in either zone, stop the grader and determine the cause.

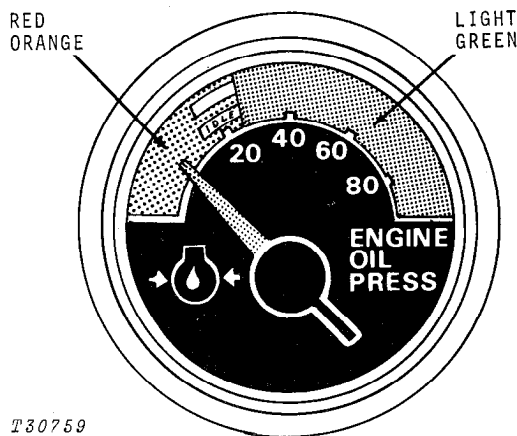

T30759

Fig. 21-Engine Oil Pressure Gauge

During normal operations, the indicator hand on the engine oil pressure gauge should be in the light green zone on the dial. If the indicator hand goes into the red-orange zone, stop the grader and check the engine oil level. If oil level is not low, check for restrictions in oil lines or incorrect viscosity oil.

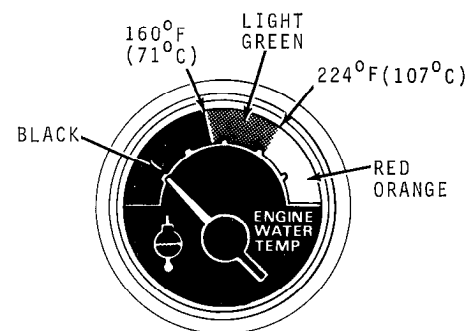

T38572

Fig. 23-Engine Coolant Temperature Gauge

The engine coolant temperature gauge indicates the coolant temperature in the cooling system. Normal operating temperature is indicated by the light green zone on the dial. If above 224°F (107°C) (indicated by the red-orange zone on the dial), stop engine and determine the cause.

Gauges and indicators operational

Yes No

## 19. Check Light Operation

Check operation of the following lights.

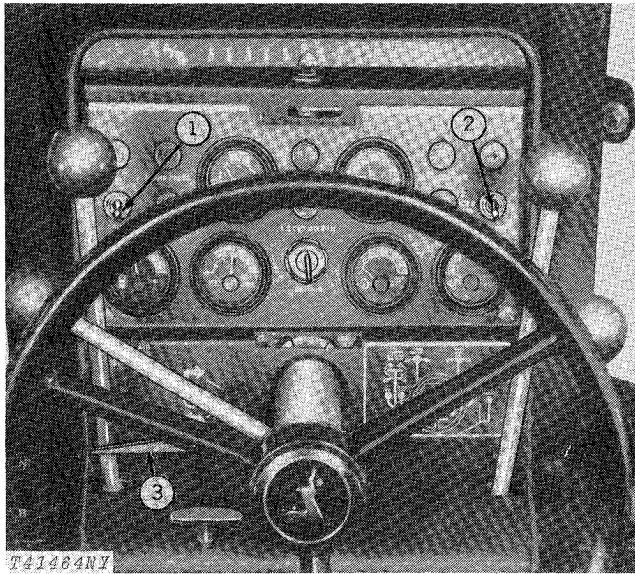

1—Drive Light Switch                      3—Turn Light Switch  
2—Work Light Switch

Fig. 24—Light Switches

The drive light switch (1) is on the left side of the instrument panel. With the switch lever in the down position the lights are off; with the switch lever in the up position the drive lights are on. The dimmer switch is located on the bottom left floor plate. When the switch button is pressed, the driving lights change from high beam to low beam or low to high.

The work light switch (2) is located on the right side of the instrument panel. With the switch lever in up or "F" position the front work lights are on, with the lever in the down or "F-R" position the front and rear work lights are on, and with the switch in the center or "OFF" position the work lights are off.

The turn light switch (3) is controlled by a lever near the steering column. When the lever is down, the left turn lights flash; when the lever is in the first up position, the right turn lights flash; when the lever is all the way up, all warning lights flash; and when the lever is in the "N" position, no lights will flash.

All lights checked                                              Yes              No

## 20. Check Transmission Shifting

The John Deere Power Shift Transmission provides eight forward and four reverse speeds. It can be shifted "on the go" or when the grader is stopped by moving the transmission speed selector and direction selector levers to the desired positions. Check transmission speed selector lever contact stops in engaged and disengaged positions.

*NOTE: The parking brake must be released before the direction selector lever can be shifted out of neutral.*

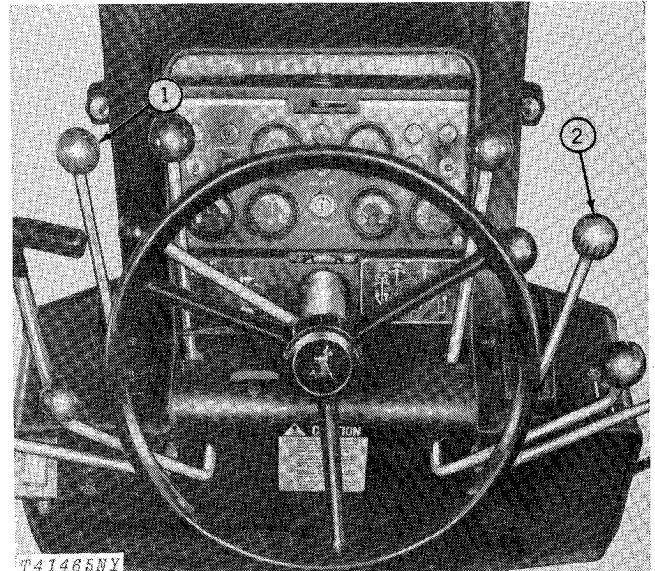

1—Direction Selector Lever  
2—Transmission Speed Selector Lever

Fig. 25—Transmission Controls

Shift transmission through all ranges. If transmission does not respond see Section 3 for repair.

Transmission operational                                              Yes              No

## 21. Checking Tire Pressure

Check the air pressure in all the tires with an accurate gauge having 1 psi (0.07 bar) graduations.

**IMPORTANT: All tires must be inflated to the same pressure.**

Adjust pressure in tires to the following specifications:

Tire Size	Ply Rating	Inflation Pressures psi (bar)
13.00-24	8	25 (1.7)
13.00-24	10	30 (2.1)
13.00-24	12	35 (2.4)
14.00-24	10	30 (2.1)
14.00-24	12	35 (2.4)
17.5-25	12	25 (1.7)

Tire pressure checked Yes No

## 22. Check Differential Lock Operation

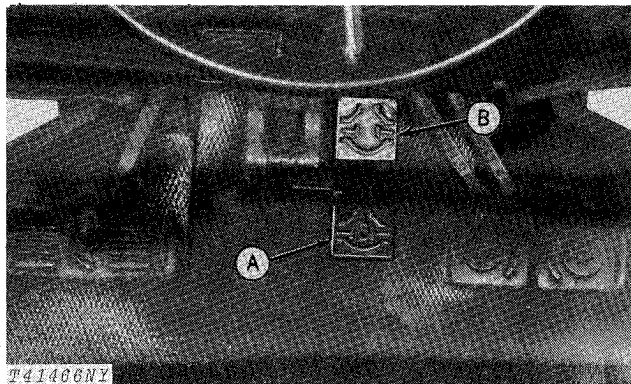

A—Engage

B—Disengage

Fig. 26-Differential Lock Pedal

Check differential lock operation.

With the engine off and the differential lock engaged, raise both wheels on one side of grader off the ground.

Attempt to rotate the wheels manually. If differential lock is functioning correctly, raised wheels will lock in place.

Differential lock checked Yes No

## 23. Hydraulic Brakes

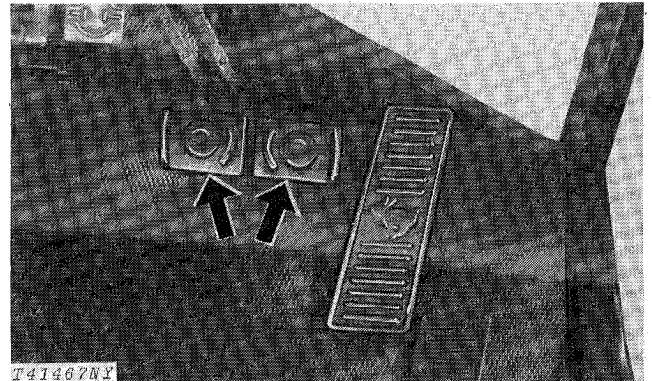

Fig. 27-Brake Pedals

Check brake system for leaks or improper operation.

Put grader in gear and depress brake pedal. Moderate pedal force should hold grader in place.

If pedal force does not hold grader in place, pedal feels spongy or bottoms out, repair is required, or system may require bleeding (page I-IV-30).

Brakes operational Yes No

## 24. Check Blade Lever Operation

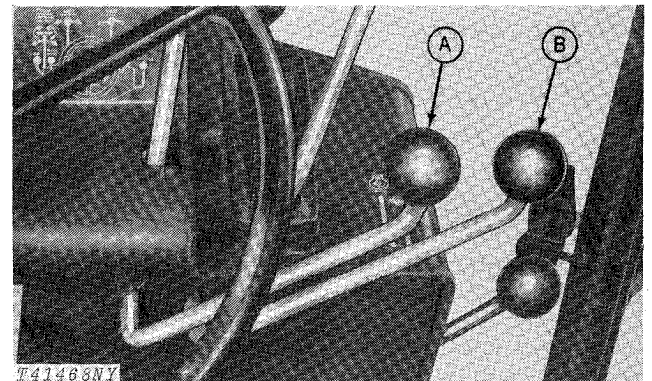

A—Left Blade Lift Lever

B—Right Blade Lift Lever

Fig. 28-Blade Lift Levers

Move levers A and B forward to lower the blade and rearward to raise the blade. Levers can be operated individually to position the blade at the desired working angle, or operated at the same time to lower the blade to working depth.

Blade lever action checked Yes No

## 25. Clutch Pedal Adjustment

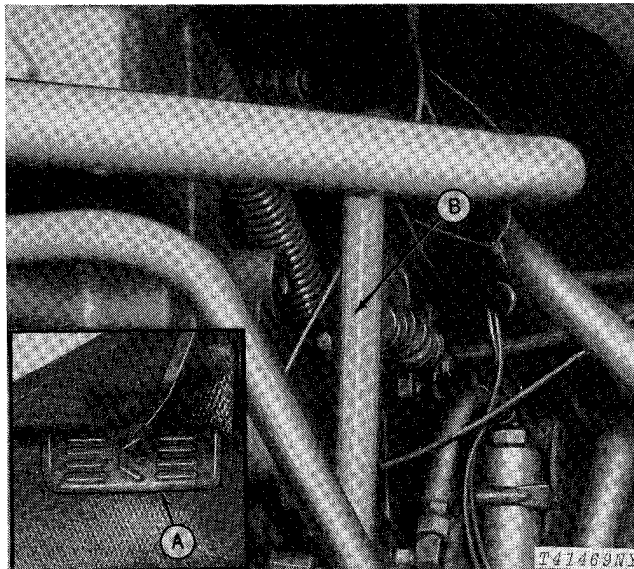

A—Clutch Pedal

B—Clutch Valve  
 Control Lever

Fig. 29-Clutch Pedal Adjustment

Depress clutch pedal (A) until clutch valve control lever (B) is rotated counterclockwise against the stop. The bottom of the clutch pedal must clear the floor plate.

Adjust the clutch valve adjusting yoke (attached to the control lever) so bottom of clutch pedal clears floor plate.

Clutch pedal adjustment checked Yes No

## 26. Steering

Start engine and turn steering wheel. Steering should be free and easy with engine running.

Steering operational Yes No

## 27. Lubrication

The motor grader was checked and lubricated before it left the factory. However, to insure customer satisfaction, check each lubrication point shown on the following pages. Lubricate with several strokes of John Deere Multi-Purpose Grease or equivalent, if necessary.

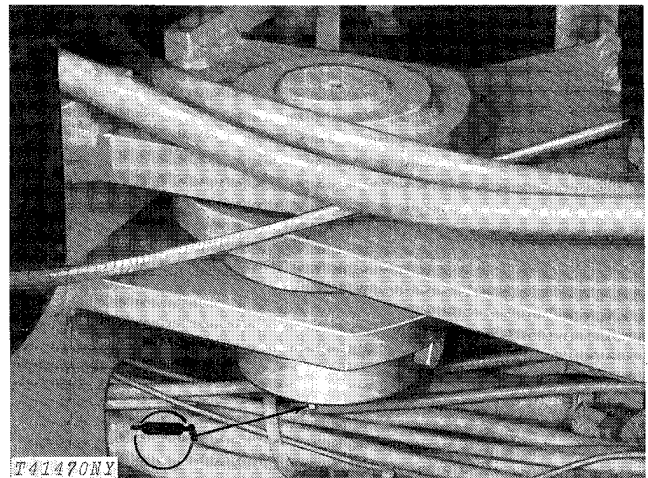

Fig. 30-Frame Pivot (Upper Shown)

Also lubricate the bottom hinge area of the frame pivot.

Lubricant required Yes No

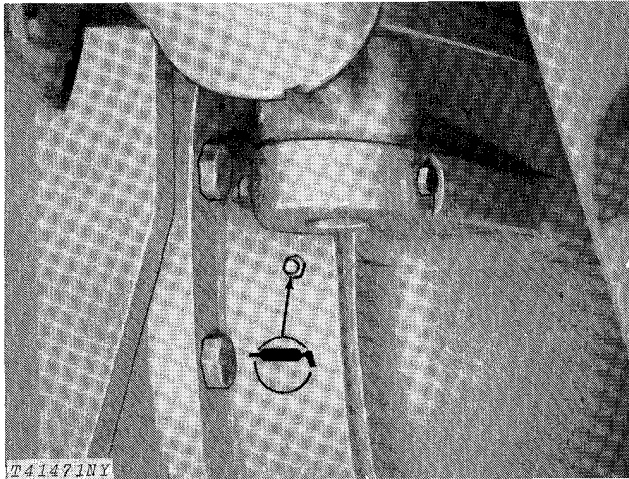

Fig. 31-Tandem Pivot  
 (Right side shown)

Fitting shown is on the front of the tandem pivot housing between the final drive housing and the tandem housing.

Lubricant required Yes No

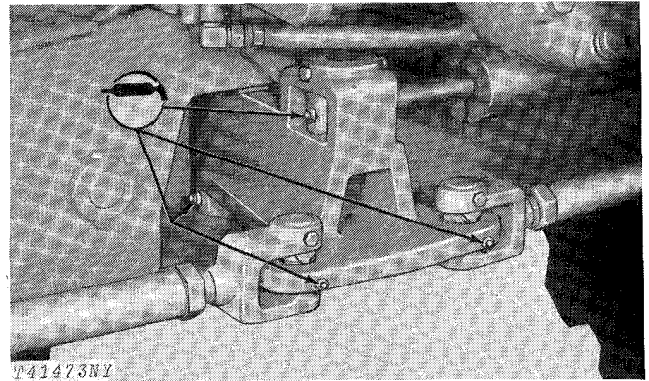

Fig. 33-Steering Yoke and Tie Bars

Lubricant required Yes No

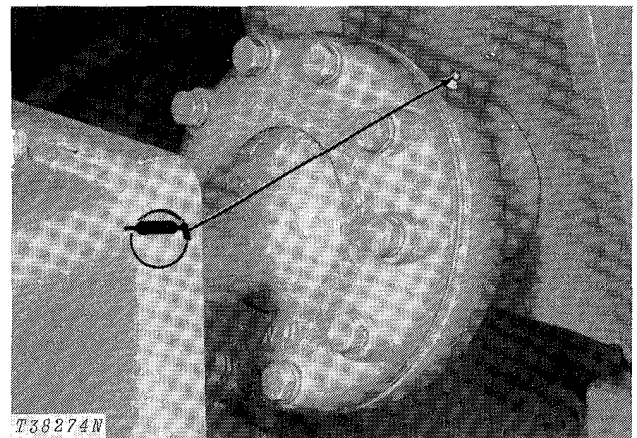

Fig. 34-Draft Ball Pivot

Lubricant required Yes No

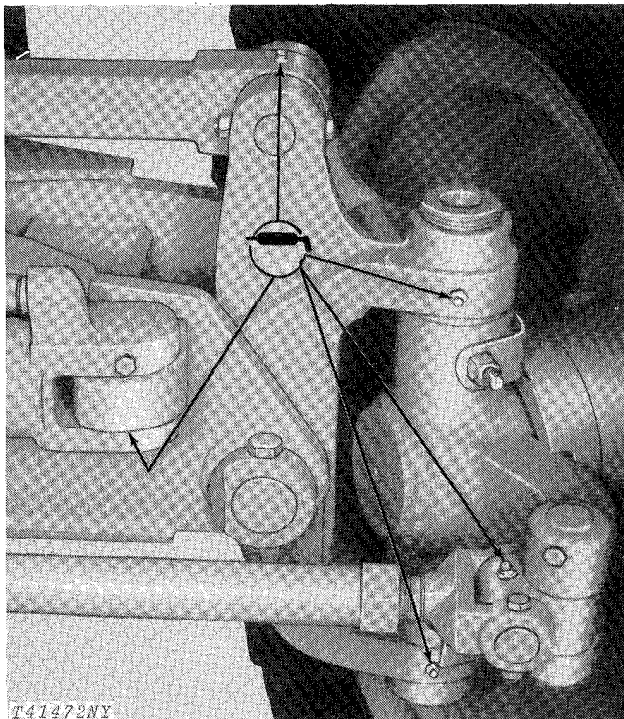
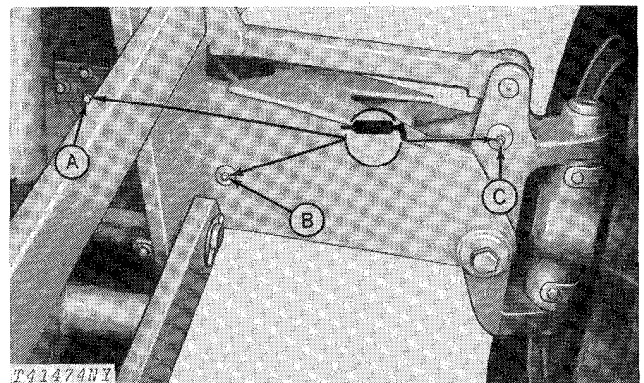

Fig. 32-Front Axle Grease Fittings  
 (Right side shown)

Lubricant required Yes No



A—Oscillation Pivot  
 B and C—Wheel Lean Pivots

Fig. 35-Front Axle Oscillation Pivot  
 and Wheel Lean Pivots

NOTE: Lubricate front axle oscillation pivot at front fitting as shown and at rear fitting (not shown).

Lubricant required Yes No

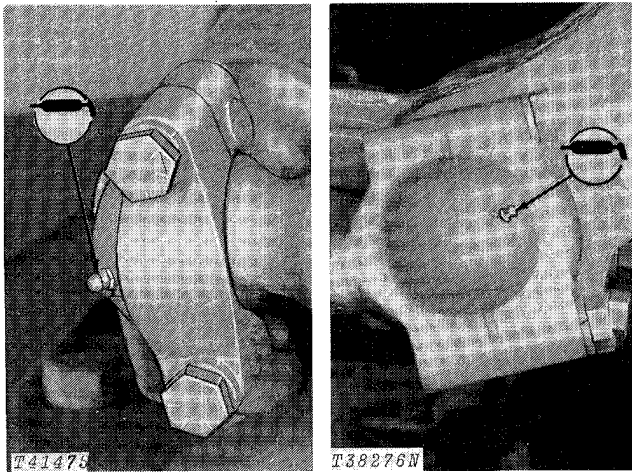

Fig. 36-Circle Side-Shift Cylinder

Lubricant required Yes No

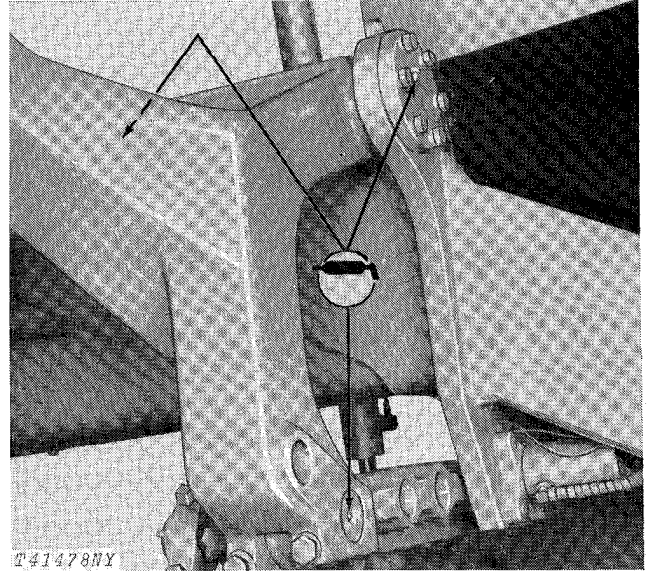

Fig. 39-Lift Arm Pivots  
 (Left rear shown)

NOTE: Lubricate the front lift arm pivots indicated above by dotted line.

Lubricant required Yes No

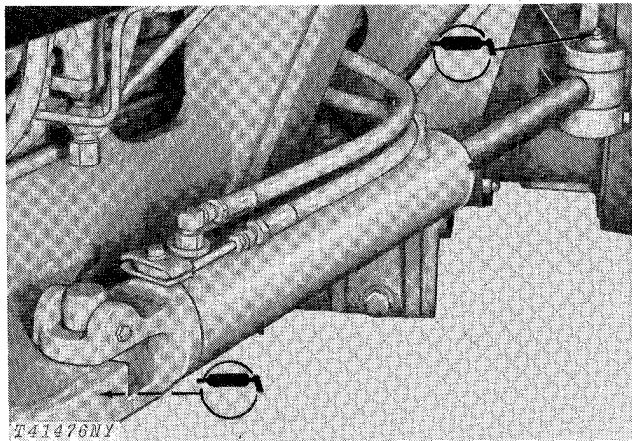

Fig. 37-Steering Cylinder  
 (Left side shown)

Lubricant required Yes No

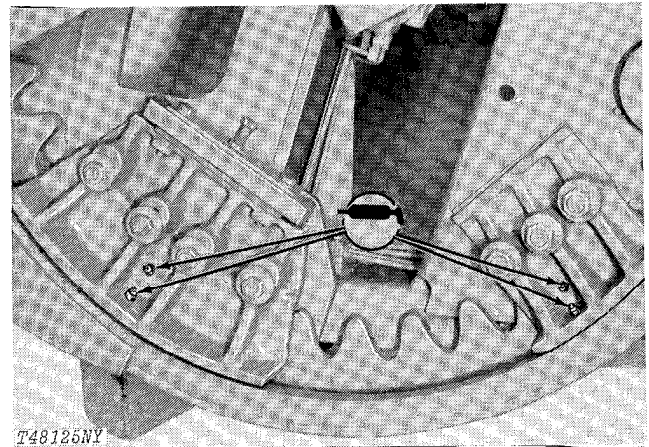

Fig. 40-Circle Wear Area (8 fittings total)

Lubricant required Yes No

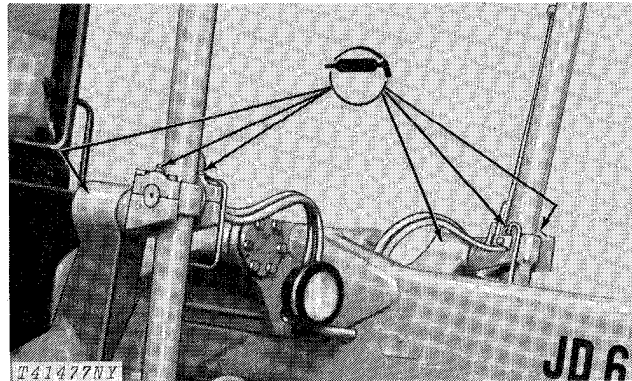

Fig. 38-Lift Cylinder Trunnion  
 (Right side shown)

Lubricant required Yes No

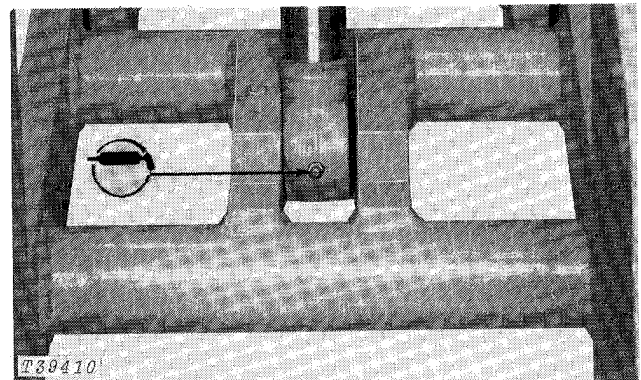

Fig. 41-Scarifier Lift Cylinder-Rod End (if equipped)

Lubricant required Yes No

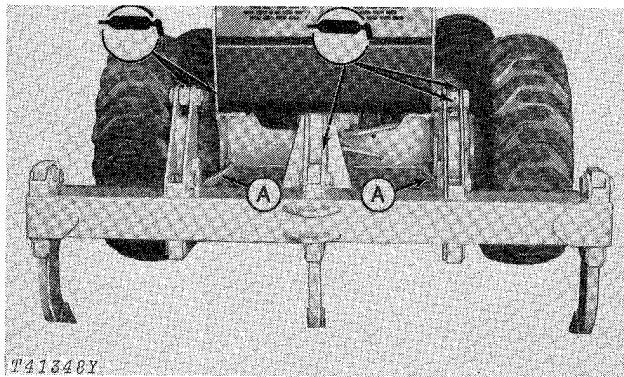

Fig. 42-Ripper Lubrication (if equipped)

Pivot pins on the front ends of both plates marked A.

Both ends of lift cylinder. In all, ten points should be lubricated.

Lubricant required Yes No

### 28. Wheel Retaining Cap Screws

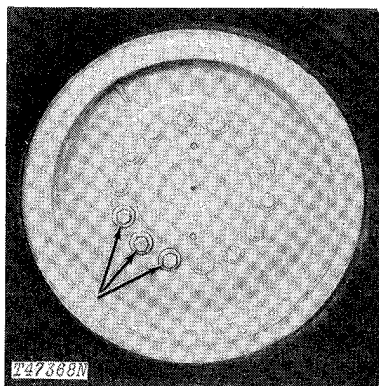

Fig. 43-Wheel Retaining Cap Screws

Check torque on all wheel retaining cap screws. Tighten wheel retaining cap screws to 300 lb-ft (407 Nm).

Wheel retaining cap screws tightened Yes No

### 29. Check Accumulator Action

Check the accumulator reserve capacity as outlined on page I-IV-33.

Accumulator checked Yes No



### 30. Fluid Leakage

Check the following systems for leakage due to poor or faulty connections and broken hoses or lines.

A. Cooling system checked	Yes	No
B. Hydraulic system checked	Yes	No
C. Transmission system checked	Yes	No
D. Fuel system checked	Yes	No

### 31. Accessible Hardware Torque Values

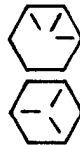
Check all accessible bolts and nuts for proper tightness. If hardware is loose, tighten it to the proper torque. The table below gives correct torque values for various bolts and cap screws. Most hardware used is high-strength (note dashes on hex. heads).

RECOMMENDED TORQUE IN LB-FT (Nm) COARSE AND FINE THREADS			
	B	D	F
			
Bolt Diameter	Plain Head	Three Dashes	Six Dashes
1/4	Not used	10 (14)	14 (19)
5/16	Not used	20 (27)	30 (41)
3/8	Not used	35 (47)	50 (68)
7/16	35 (47)	55 (75)	80 (108)
1/2	55 (75)	85 (115)	120 (163)
9/16	75 (102)	130 (176)	175 (237)
5/8	105 (142)	170 (230)	240 (325)
3/4	185 (251)	300 (407)	425 (576)
7/8	160 (217)	445 (603)	685 (929)
1	250 (339)	670 (908)	1030 (1396)
1-1/8	330 (447)	910 (1234)	1460 (1979)
1-1/4	480 (651)	1250 (1695)	2060 (2793)

T41359

Fig. 44-Torque Chart

The types of bolts and cap screws are identified by head markings as follows:

Plain Head: regular machine bolts and cap screws.

3-Dash Head: tempered steel high-strength bolts and cap screws.

6-Dash Head: tempered steel extra-high strength bolts and cap screws.

Machine bolts and cap screws 7/8-inch and larger are sometimes formed hot rather than cold, which accounts for the lower torque.

All accessible hardware tightened Yes No

### 32. Final Check

The final predelivery procedure is the overall clean-up of the motor grader. Make the motor grader LOOK like a new machine with the proper touch-up of chipped paint and a good wash job. Deliver to the customer a machine anyone would be proud to own.

## DELIVERY SERVICE

A thorough discussion of the operation and service of this motor grader at the time of delivery helps to assure complete customer satisfaction. Proper delivery should be an important phase of a dealer's program. A portion of the John Deere Delivery Receipt emphasizes the importance of proper delivery service.

Many complaints arise because the owner was not shown how to operate and service the new motor grader properly. Devote enough time at the customer's convenience, to introduce the owner to the new motor grader and explain how to operate and service it.

The following procedure is recommended before the service technician and owner complete the delivery acknowledgments portion of the Delivery Receipt.

Using the operator's manual as a guide to be sure that the owner understands these points thoroughly:

1. The importance of safety.
2. The importance of lubrication and periodic services.
3. The importance of the break-in period.
4. Controls and instruments.
5. How to start and stop the engine.
6. All functions of the hydraulic system.

After explaining and demonstrating the above features, have the owner sign the Delivery Receipt and give the owner the operator's manual.

## AFTER-SALE INSPECTION

The purchaser of a new John Deere motor grader is entitled to a free inspection at some mutually agreeable time within the warranty period after the equipment has been "run in," usually after 50 to 100 hours of motor grader operation. The terms of this after-sale inspection are outlined on the customer's John Deere Delivery Receipt.

This inspection is to make sure that the customer is receiving satisfactory performance from the motor grader. At the same time, the inspection should reveal whether or not the motor grader is being operated, lubricated, and serviced properly.

If the recommended after-sale service inspection is followed, the dealer can eliminate a needless volume of service work by preventing minor irregularities from developing into serious problems later on. This will promote strong dealer-customer relations and present the dealer an opportunity to answer questions that may have arisen during the first few days of operation.

During the inspection service, the dealer has the further opportunity of promoting the possible sale of other new equipment.

Check operation of all controls and instruments for freedom of movement and correct operation.

## 1. Engine Crankcase Oil and Filter Element

**NOTE:** Check with the customer if oil has been changed and filter replaced before performing this service.

Normal sequence of service is as follows:

- Oil and filter change - after first 100 hours
- every 200 hours thereafter

If changed, record information below:

Approximate hours at change \_\_\_\_\_

If not, change as follows:

- 1 - Run engine to heat oil.
- 2 - Drain oil from engine crankcase.
- 3 - While crankcase is draining, replace filter element as follows.

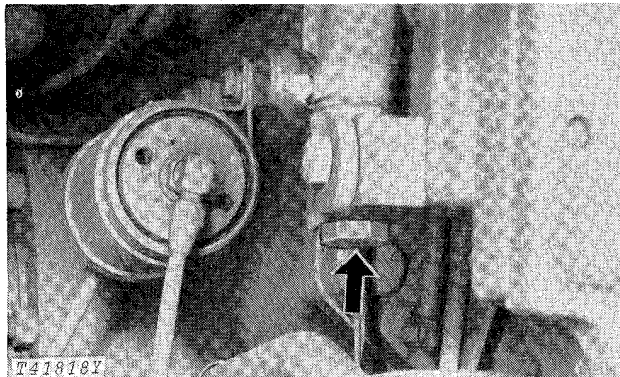

Fig. 45-Engine Crankcase Drain Plug

- A - Remove drain plug from filter housing.
- B - Remove filter element (turn counterclockwise).

- C - Clean mounting surface.
- D - Apply film of oil to sealing ring.
- E - Tighten element until sealing ring touches mounting surface.
- F - Turn an additional 1/2 to 3/4 turn.
- G - Do not overtighten.
- H - Install drain plug in filter housing.

4 - Install drain plug in engine crankcase.

5 - Fill crankcase with new oil of proper viscosity. Capacity is 18 quarts (17 L) without filter, 20 quarts (19 L) with filter.

6 - Run engine a short time and check for leaks at filter base, filter housing drain plug and engine crankcase drain plug. Tighten filter if required.

7 - Stop engine.

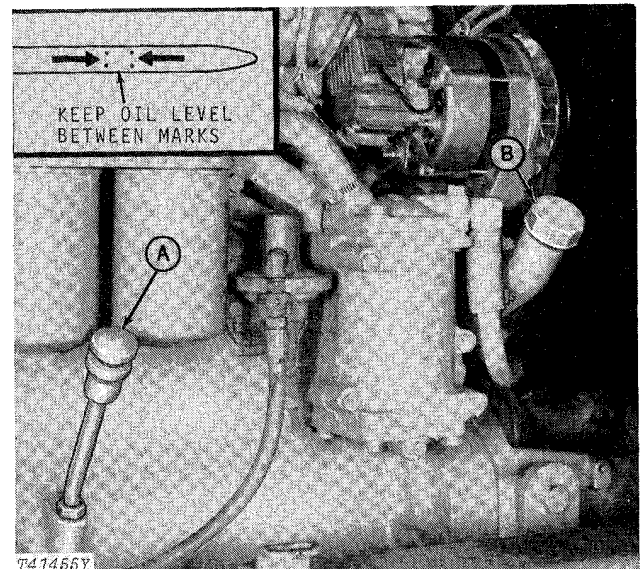

A—Dipstick

B—Oil Filler Cap

Fig. 46-Crankcase Oil Level

- 8 - Check oil level. Level should be at top mark on dipstick while resting on filler tube.

Crankcase oil changed	Yes	No
Oil filter element changed	Yes	No
Oil added	_____	qts. (L)

## 2. Transmission-Hydraulic System Oil Level and Filter Elements

*NOTE: Before checking oil level find out if customer has changed filter elements (first 100 hours service).*

If changed at an earlier date, record information below:

Approximate hours at change \_\_\_\_\_

If not, change as follows:

- 1 - Run engine to heat oil.
- 2 - Remove transmission-hydraulic system drain plugs and transfer drive gear housing plug and drain oil.
- 3 - While transmission is draining, replace the transmission and hydraulic oil filter elements as follows:

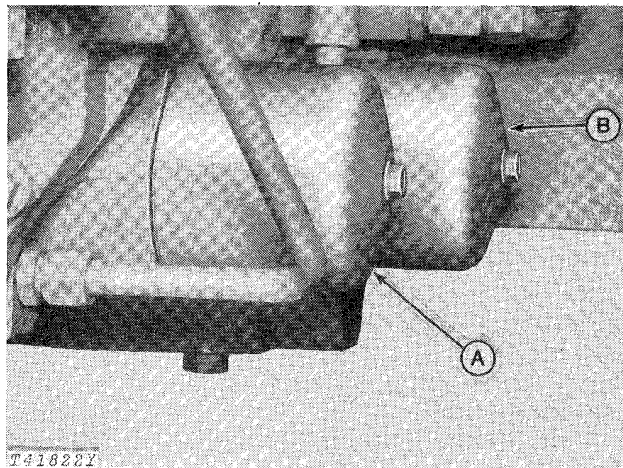

A—Transmission Oil Filter

B—Hydraulic Oil Filter

Fig. 47-Transmission - Hydraulic System Filters

- A - Loosen filter covers slightly to allow oil to drain.
- B - Remove filter covers.
- C - Remove packings and elements.
- D - Install new packings. Be sure they are fully seated.
- E - Install filter covers with new elements.

- 4 - Install transmission-hydraulic system drain plugs and transfer drive gear housing plug.

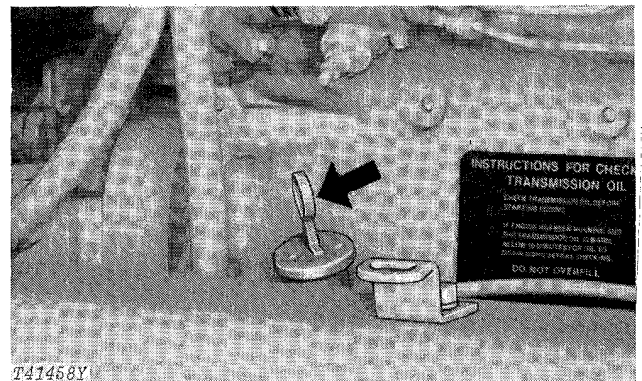
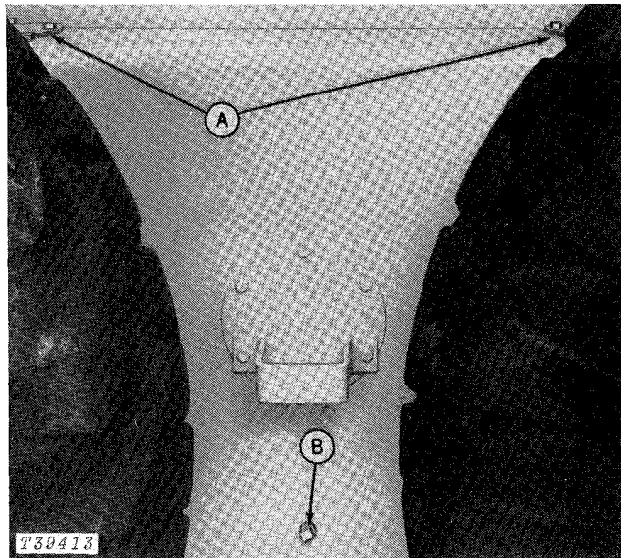

Fig. 48-Transmission-Hydraulic System Filler Cap and Dipstick

- 5 - Fill transmission-hydraulic system with oil specified on page I-V-2.
- 6 - Run engine a short time and check for leaks at filter bases and drain plugs. Tighten filter covers if required.
- 7 - Stop engine.
- 8 - Check oil level after engine has been shut off a minimum of 10 minutes. Level should be at top mark on dipstick while resting on filler tube.

Oil level checked	Yes	No
Transmission-hydraulic system oil filter elements replaced	Yes	No

### 3. Tandem Drives



**A—Inspection Plates** **B—Oil Level Plug**

Fig. 49-Tandem Drive

With the grader on a level surface, check oil in both tandems by removing the oil level plug. Oil must be level with the check plug hole. If necessary, add oil specified on page I-V-2 through one of the holes under inspection plates.

Tandem drives oil level checked	Yes	No
Oil added	_____qts. (L)	

### 4. Circle Drive Gear Box

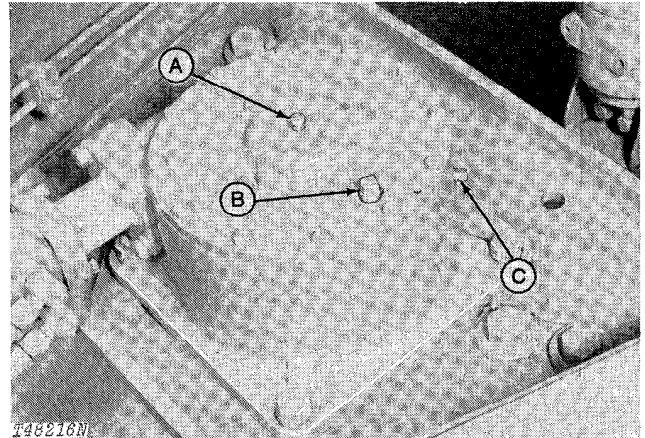

**A—Vent** **B—Filler Plug** **C—Oil Level Plug**

Fig. 50-Circle Drive Gearbox

With the draft frame level and blade on ground, check circle drive gearbox oil level by removing the oil level plug. Oil must be level with the plug hole. If necessary, add oil specified on page I-V-2. Replace filler plug.

Circle drive gearbox oil level checked	Yes	No
Oil added	_____qts. (L)	

### 5. Pre-Cleaner

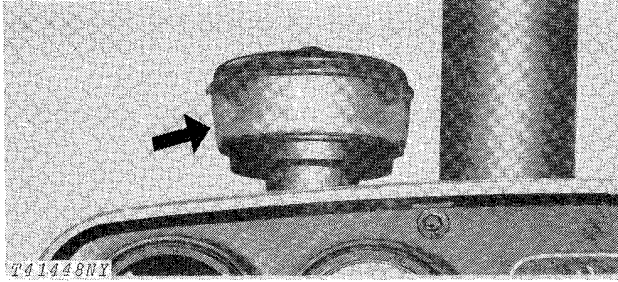

Fig. 51-Pre-cleaner

Check pre-cleaner bowl. Clean it, if necessary.

Pre-cleaner checked and cleaned Yes No

### 6. Air Cleaner

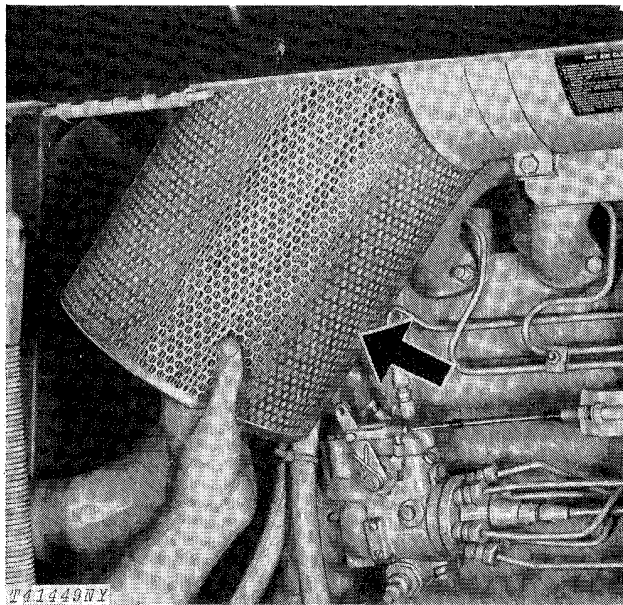

Fig. 52-Primary Element

Check air cleaner elements for clogging or damage. Clean primary element, if dirty. If elements are ruptured, install new primary elements.

Air cleaner elements checked Yes No  
 New elements installed Yes No

### 7. Radiator

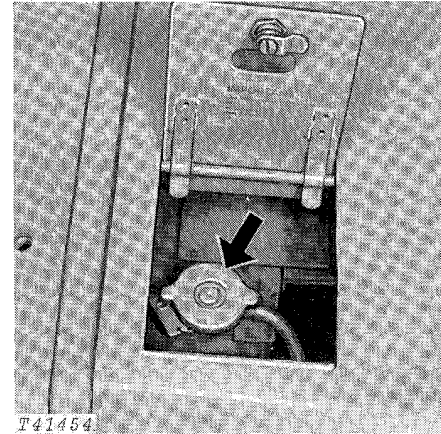

Fig. 53-Radiator Filler Cap

**CAUTION:** Remove radiator filler cap only when coolant temperature is below the boiling point. Then loosen cap slightly to the stop to relieve pressure before removing the cap completely.

Check coolant level in radiator. Coolant must be 4 inches (102 mm) below the top of the filler neck.

Radiator coolant level checked Yes No  
 Coolant or anti-freeze added \_\_\_\_\_qts. (L)

### 8. Batteries

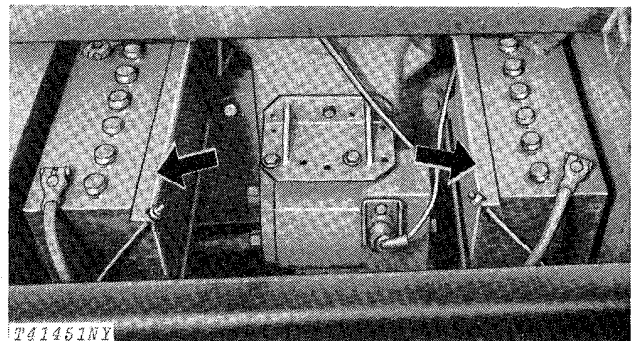

Fig. 54-Batteries

Remove foreign material from top of battery. Check battery electrolyte level. If distilled water is not available, use clean soft water. Coat terminals with petroleum jelly.

**IMPORTANT:** Never add water to battery in freezing weather unless engine will be run 2 or 3 hours.

Water added Yes No  
 Battery connections checked Yes No

## 9. Check Tire Pressure

Check the air pressure in all the tires with an accurate gauge having 1 psi (0.07 bar) graduations.

**IMPORTANT: All tires must be inflated to the same pressure.**

Adjust pressure in tires to the following specifications:

Tire size	Ply Rating	Inflation Pressures psi (bar)
13.00-24	8	25 (1.7)
13.00-24	10	30 (2.07)
13.00-24	12	35 (2.41)
14.00-24	10	30 (2.07)
14.00-24	12	35 (2.41)
17.5-25	12	25 (1.72)

**CAUTION:** Failure to follow proper procedures when mounting a tire on a wheel or rim can produce an explosion which may result in serious bodily injury. DO NOT attempt to mount a tire unless you have the proper equipment and experience to perform the job safely.

Detailed tire mounting instructions, including necessary safety precautions, are contained in John Deere Fundamentals of Service (FOS) Manual 55, Tires and Tracks.

Tire pressure checked Yes No

## 10. Fuel Tank

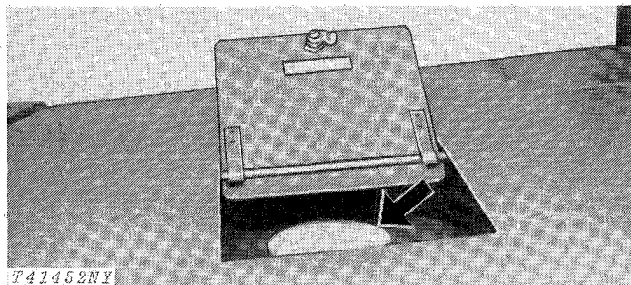

Fig. 55-Fuel Tank Filler Cap

Check fuel gauge. Turn on key switch and check for movement of indicator on gauge. If no movement is noted, add a small amount of fuel and repeat procedure.

If no indicator movement is noted, gauge is not functioning.

Fuel gauge functional Yes No

## 11. Fuel Tank Sump

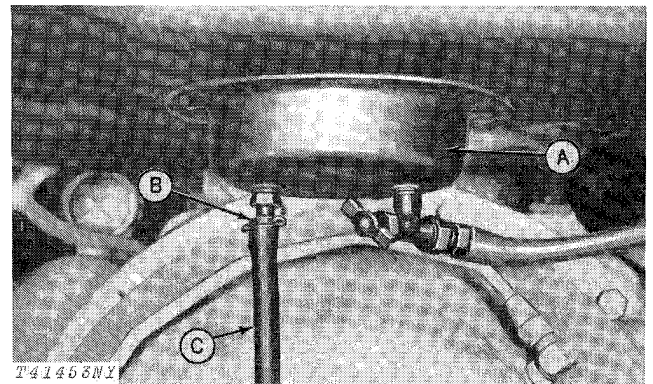

A—Fuel Tank Sump B—Drain Cock C—Plastic Hose

Fig. 56-Fuel Tank Sump

Open fuel tank drain cock. Drain liquid for several seconds. Close drain cock.

Fuel sump drained Yes No

## 12. Fuel Filter

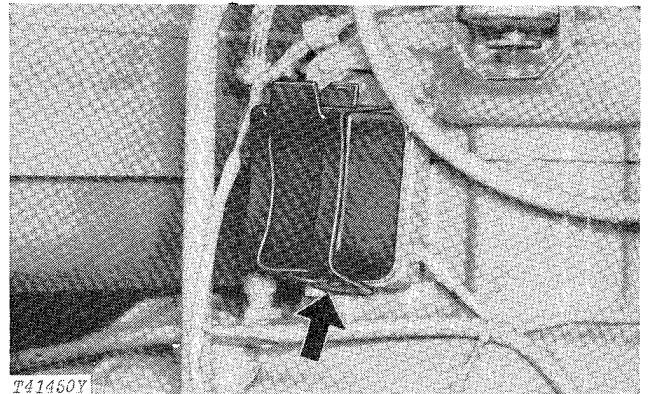

Fig. 57-Fuel Filter

Check fuel filter for sediment. Drain if necessary.

Sediment present in filter Yes No

### 13. Check Lubrication

Check each lubrication point shown in the following pages. Lubricate with several strokes, if necessary.

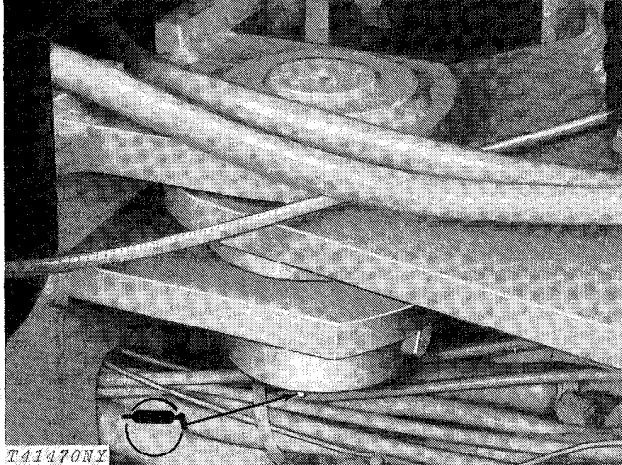

Fig. 58-Frame Pivot (Upper Shown)

Also lubricate the bottom hinge area of the frame pivot. Grease fitting is on the engine frame pivot plate.

Lubricant required Yes No

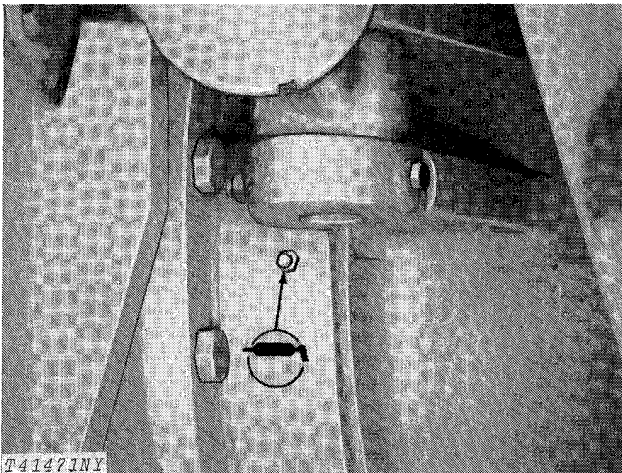

Fig. 59-Tandem Pivot (Right Side Shown)

Fitting shown is on the front of the tandem pivot housing between the final drive housing and the tandem housing.

Lubricant required Yes No

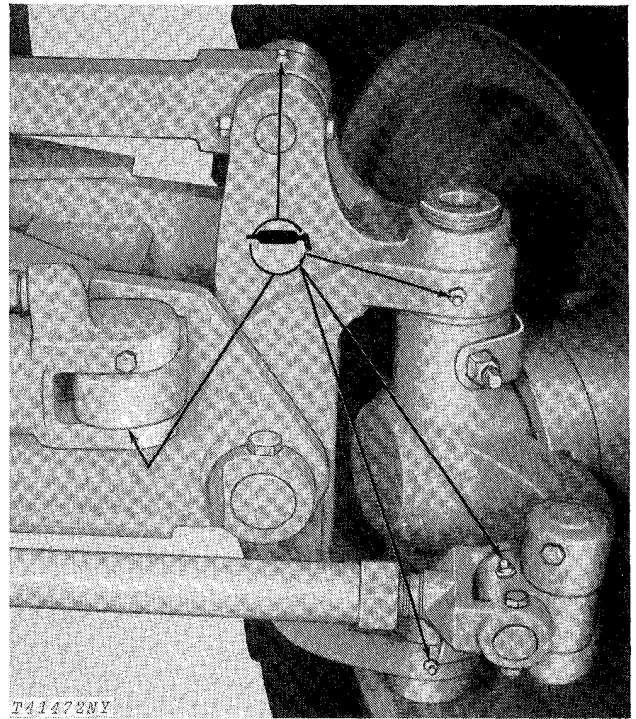

Fig. 60-Front Axle Grease Fittings  
 (Right Side Shown)

Lubricant required Yes No

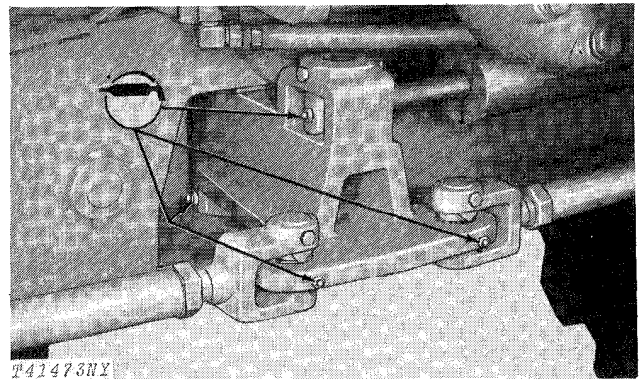

Fig. 61-Steering Yoke and Tie Bars

Lubricant required Yes No

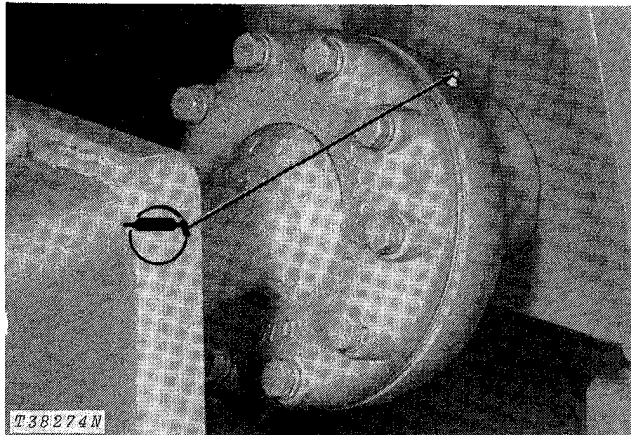

Fig. 62-Draft Ball Pivot

Lubricant required Yes No

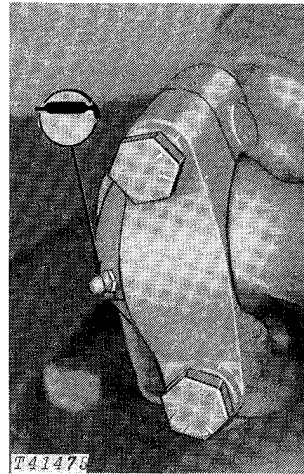

Fig. 64-Circle Side-Shift Cylinder

Lubricant required Yes No

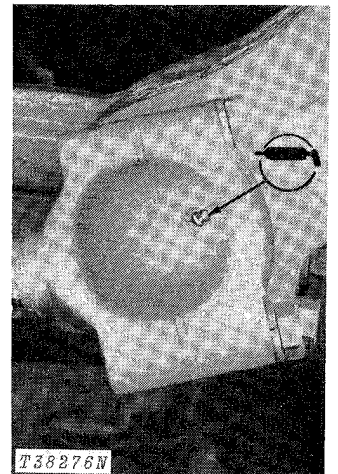
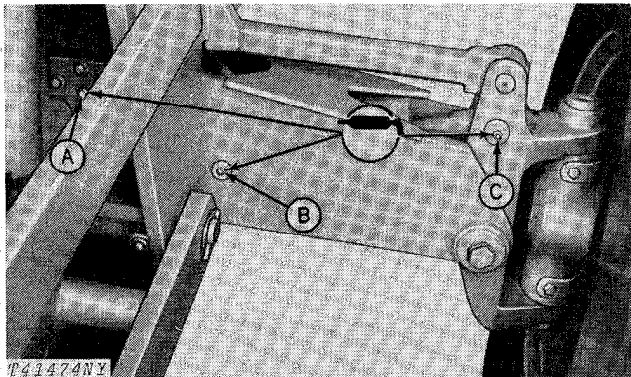

Fig. 65-Steering Cylinder  
 (Left side shown)

Lubricant required Yes No



A—Oscillation Pivot  
 B and C—Wheel Lean Pivots

Fig. 63-Front Axle Oscillation Pivot  
 and Wheel Lean Pivots

**NOTE:** Lubricate front axle oscillation pivot at front fitting as shown and at rear fitting (not shown).

Lubricant required Yes No

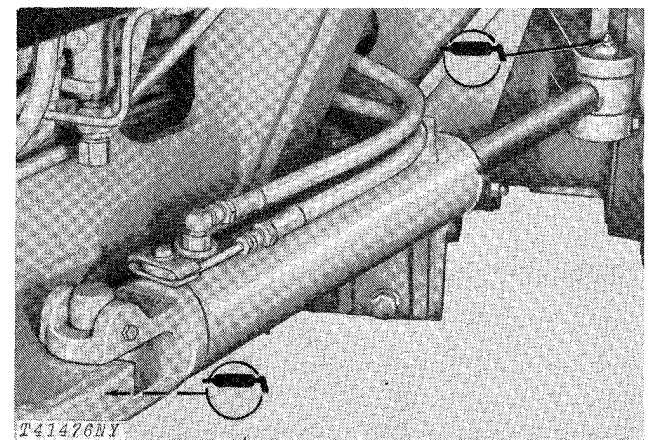

Fig. 66-Lift Cylinder Trunnion  
 (Right side shown)

Lubricant required Yes No

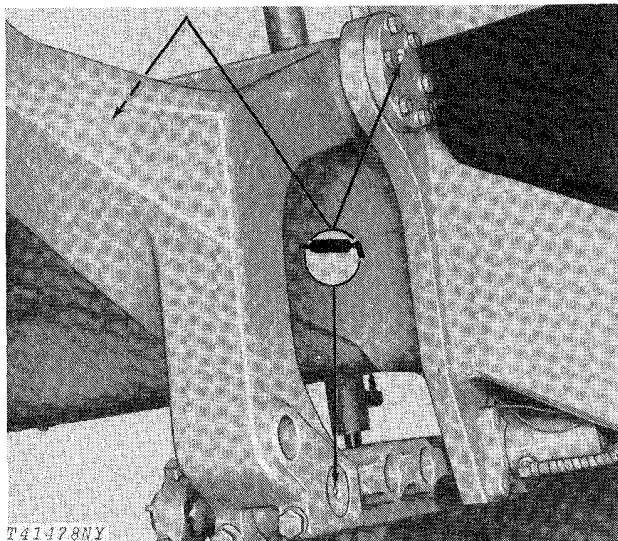

Fig. 67-Lift Arm Pivots (Left rear shown)

**NOTE:** Lubricate the front lift arm pivots indicated above by dotted line.

Lubricant required Yes No

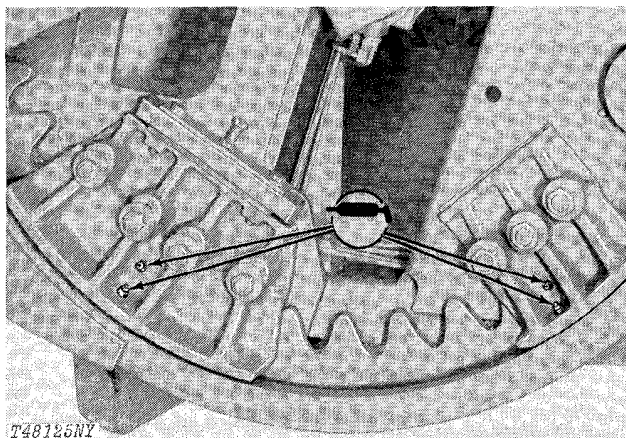

Fig. 68-Circle Wear Area (8 fittings total)

Lubricant required Yes No

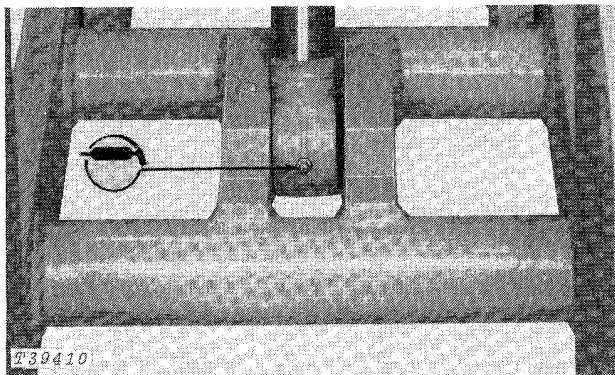

Fig. 69-Scarifier Lift Cylinder-Rod End (if equipped)

Lubricant required Yes No

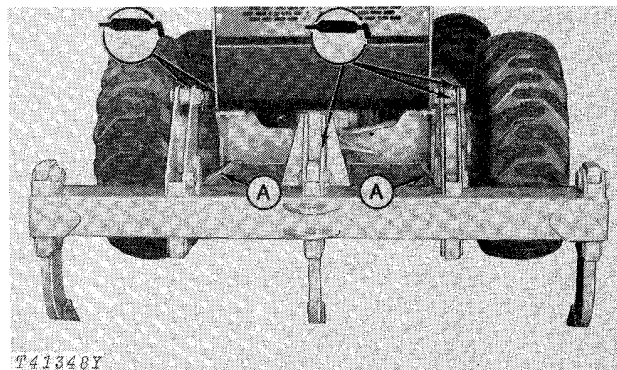

Fig. 70-Ripper Lubrication (if equipped)

Pivot pins on the front ends of both plates marked A.

Both ends of lift cylinder. In all, ten points should be lubricated.

Lubricant required Yes No

#### 14. Check Air Intake Hoses

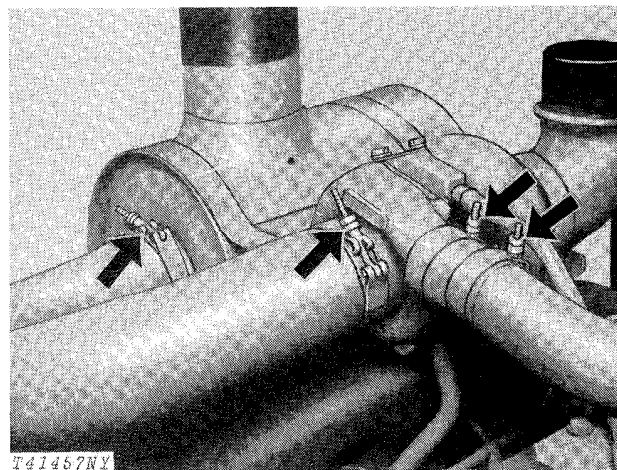

Fig. 71-Air Intake Hoses

Check clamps on hoses which connect air cleaner and turbocharger tube. Tighten hose clamps where necessary to prevent dirt from entering engine. Inspect hose for cracks.

Air intake hoses checked Yes No  
 Loose connections Yes No

## 15. Alternator-Fan Belt Tension

Check and adjust belt tension.

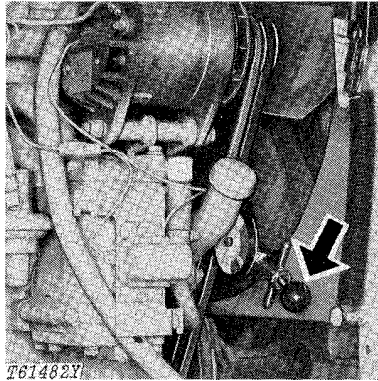

Fig. 72-Tension Gauge

Tension gauge: Immediately after engine shut down (run engine at least 5 minutes), check belt tension on front belt only. If less than 50 lb. (223 N), allow engine to cool 10 to 15 minutes, then reset tension to 90 lb. (400 N).

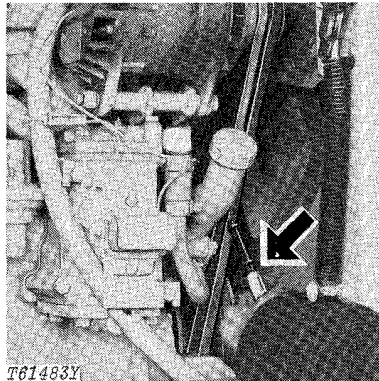

Fig. 73-Tension Tester

Tension tester: Apply 24 lb. (107 N) force midway between pulleys. Belt must deflect 1/2 in. (13 mm).

Tension adjustment: Loosen cap screws (A, Fig. 74).

**IMPORTANT:** Apply pressure **ONLY** to front alternator housing (B).

**Tighten cap screws.**

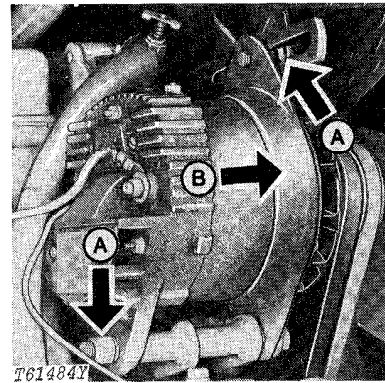

Fig. 74-Adjusting Belt Tension

Belt tension checked	Yes	No
Tension adjusted	Yes	No

## 16. Engine Speeds

Check engine speeds and adjust if necessary.

*NOTE:* Engine must be at operating temperature for the following adjustments.

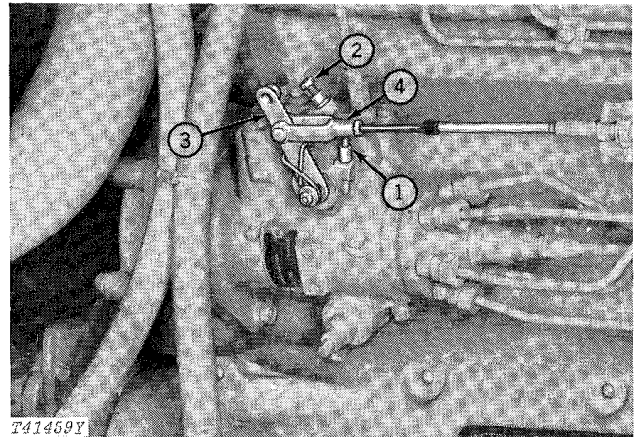

1—Fast Idle Stop Screw  
 2—Slow Idle Stop Screw

3—Throttle Lever  
 4—Yoke

Fig. 75-Injection Pump Idle Adjustment

Disconnect yoke (4, Fig. 75) connecting throttle cable to pump throttle lever.

Run engine and rotate pump throttle lever (3, Fig. 75) until fast idle stop screw contacts its stop. Engine speed should be at fast idle (2425 to 2475 rpm). If not, adjust pump fast idle stop screw (1) to correct fast idle.

Move the injection pump throttle lever to the left. When engine rpm remains the same as the lever is moved leftward, the engine is running at slow idle speed. If engine is not running at a slow idle speed of 875 to 925 rpm, adjust the pump slow idle stop screw (2, Fig. 75).

Connect throttle cable yoke to pump throttle lever.

### Accelerator-Decelerator Pedal Adjustments

Remove right shield (bolted to the front of the right footrest) for access to the accelerator-decelerator pedal linkage.

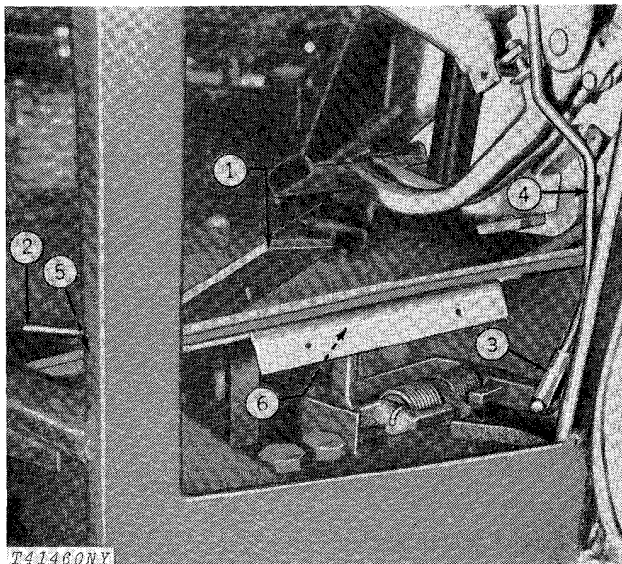

- |                       |                            |
|-----------------------|----------------------------|
| 1—Accelerator Pedal   | 4—Control Rod              |
| 2—Decelerator Pedal   | 5—Stop Screw (Decelerator) |
| 3—Yoke (Bottom Shown) | 6—Control Cable Yoke       |

Fig. 76-Pedal Linkage

Adjust yokes (3, Fig. 76 and 6, Fig. 77) on control rod (4, Fig. 76) to position decelerator pedal parallel to footrest. Adjust decelerator stop screw (5, Fig. 76) to contact bottom of decelerator pedal.

Adjust control cable yoke (6, Fig. 76) to obtain slow idle engine speed with decelerator pedal in parallel position as previously described.

**NOTE:** Do not set decelerator pedal to a point where engine shut-off can be achieved by pedal action.

Check to be sure that fast idle is being achieved by the accelerator pedal. Pedal adjustments for fast idle normally are not required due to override area built in.

### Speed Control Lever Adjustment

Remove right control console cover for access to speed control lever linkage.

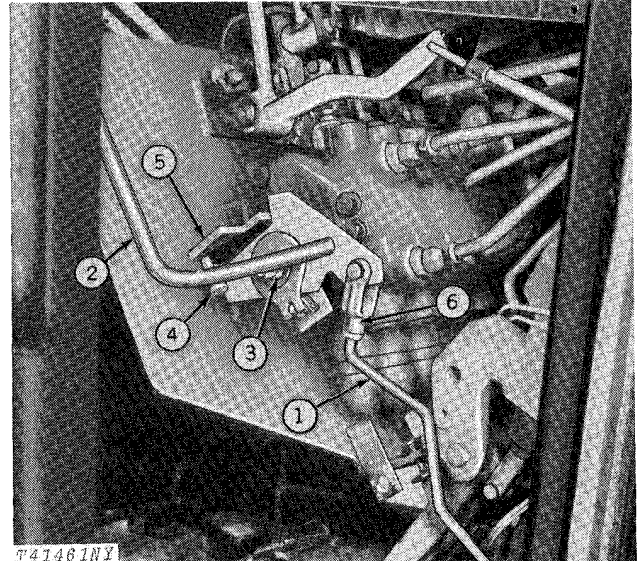

- |                       |                        |
|-----------------------|------------------------|
| 1—Speed Control Rod   | 4—Fast Idle Stop Screw |
| 2—Speed Control Lever | 5—Throttle Stop        |
| 3—Friction Spring     | 6—Yoke (Top Shown)     |

Fig. 77-Speed Control Linkage

Disconnect speed control rod (1, Fig. 77) from speed control lever (2, Fig. 77). Adjust speed control lever friction spring (3, Fig. 77) until 8 lbs. (35.5 N) pull at the end of the speed control lever is required to move the lever.

Connect the speed control rod to the speed control lever.

Adjust fast idle stop screw (4, Fig. 77) to obtain fast idle.

Position the throttle stop (5, Fig. 77) so that the speed control lever contacts the rear surface of the stop at slow idle. Position in the other direction so that the speed control lever must be moved to the right to clear the throttle stop, allowing the speed control lever to be moved rearward to the engine shut-off position.

Examine linkage for binding, looseness or any condition which might cause poor engine performance.

Engine speeds checked	Yes	No
-----------------------	-----	----

## 17. Parking Brake

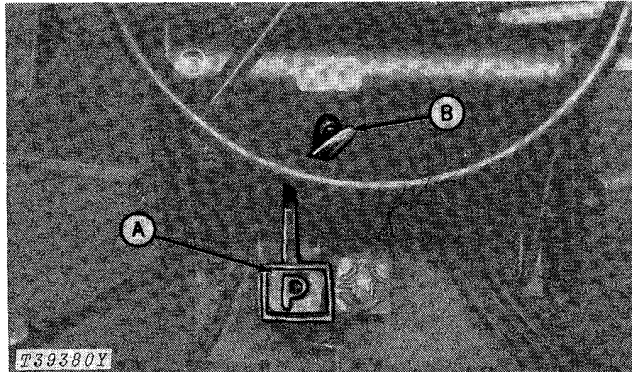

A—Engage Pedal B—Disengage Handle

Fig. 78—Parking Brake

To release the parking brake, pull handle B, while holding down pedal A to take the load off latch.

Depress parking brake. When pedal uses over 3/4 total travel to fully apply the brake, adjust the brake as follows:

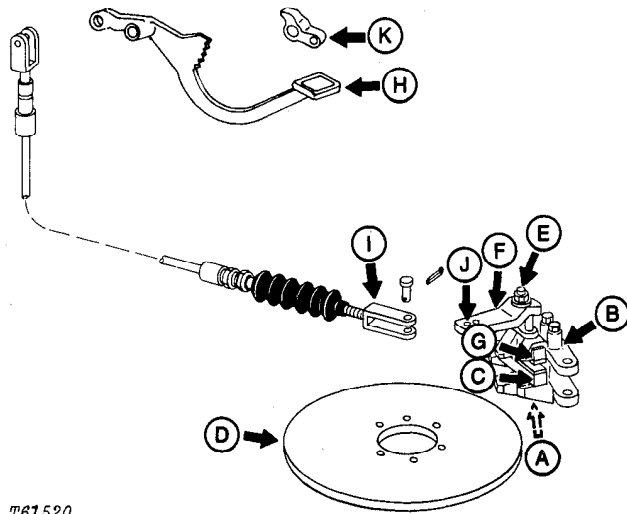

T61520

Fig. 79—Adjusting Parking Brake

- 1 - Adjust cap screw (A) in transmission cover under caliper (B), until bottom friction pad (C) just touches bottom of brake disk (D).
- 2 - Adjust lock nut (E) on top of caliper lever (F) until top friction pad (G) just touches brake disk (D).
- 3 - With parking brake pedal (H) in full raised position and caliper lever (F) in center position, adjust brake cable end yoke (I).

- 4 - Adjust yoke, at caliper, until holes in yoke are in alignment with outside hole (J) in caliper lever.
- 5 - Apply parking brake. Brake should be tight when locking pawl (K) reaches first or second notch on pedal ratchet with 70 lb. (311 N) (32 kg) force applied to brake pedal.
- 6 - Replace brake pads when remaining friction material measures less than 0.10 inch (2.5 mm).

Parking brake checked

Yes No

## 18. Circle Adjustment

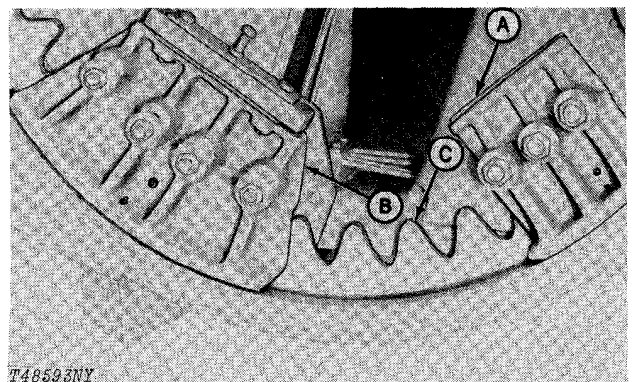

T48593NY

A—Front Support B—Rear Support C—Circle

Fig. 80—Draft Frame Components

### Vertical Clearance

Measure the vertical clearance between the front and rear circle supports and the circle. Clearance should measure 0.04 to 0.10 inch (1 to 2.5 mm). Add or deduct shims, as required.

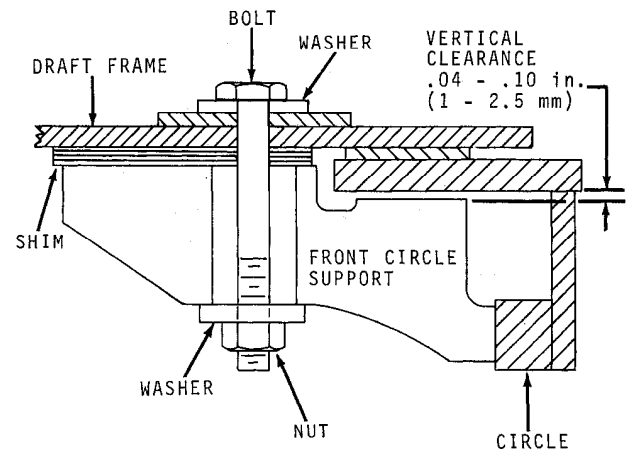

T41762

Fig. 81—Front Circle Support Adjustment

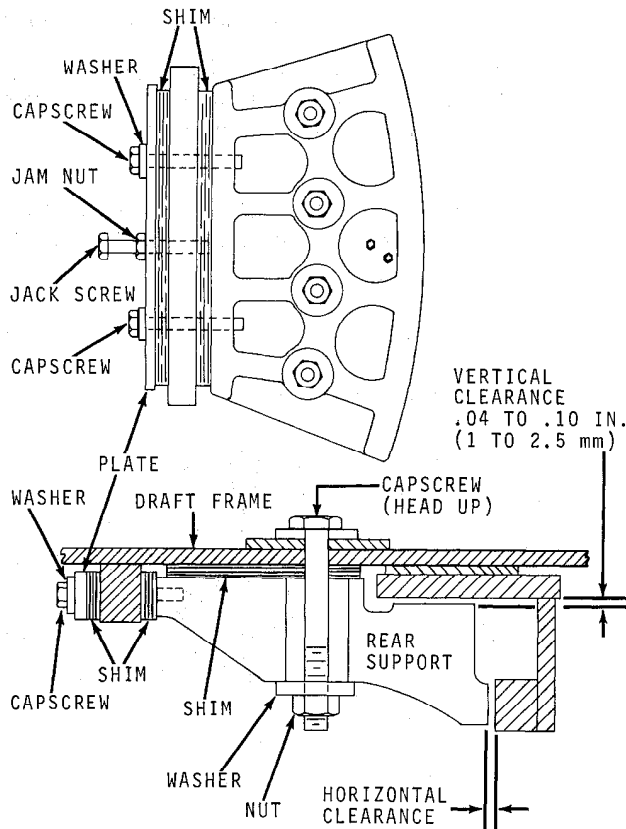

T48594N

Fig. 82-Rear Circle Support Adjustment

The front circle support shims are slotted. Remove by loosening bolts and pulling shims toward center of circle.

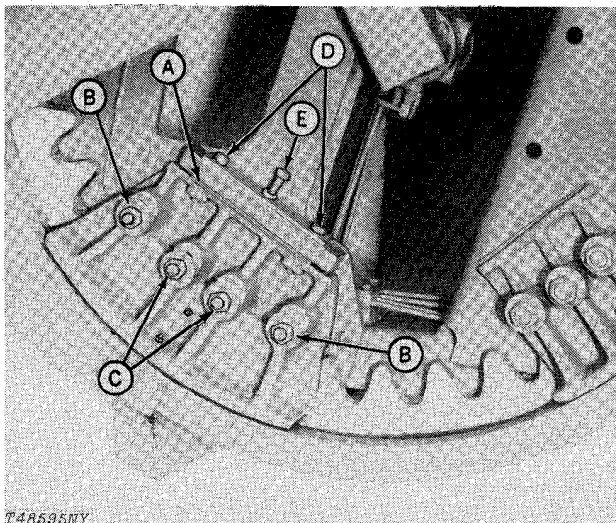

T48595NY

- |                 |                                 |
|-----------------|---------------------------------|
| A—Rear Shims    | D—Horizontal Shim<br>Cap Screws |
| B—End Bolts     | E—Jack Screw                    |
| C—Support Bolts |                                 |

Fig. 83-Rear Circle Support Components

The vertical adjustment shims under the rear circle support are also slotted and may be removed by pulling toward the center of the circle. To do this the following steps must be taken:

1. Remove washer from each of the two end bolts (B).
2. Screw nut on each end bolt for the thickness of nut only.
3. Remove the center 2 bolts (C) on each support, allowing casting to lower until resting on two nuts.

**CAUTION:** Rear support weighs approximately 90 lbs. (41 kg). Be sure casting is always supported.

4. Tip casting to allow removal of shims.

**NOTE:** If hoist is available, the two outer bolts on each rear support may be removed and a chain, strap, etc. can be placed through bolt holes to support casting. If this is done be careful not to damage hydraulic tubes on draft frame.

5. Reverse steps 1 through 3.

If horizontal clearance must be adjusted, do not tighten the 8 rear support bolts completely.

#### Horizontal Clearance

1. Loosen nuts on 8 rear support bolts slightly.
2. Loosen the 4 cap screws (D) holding the horizontal adjustment shims.
3. Turn jack screws (E) inward, equalizing the left and right supports. This forces the rear supports against the circle.
4. Continue to equally tighten jack screws until the front supports are in contact with the circle. Light effort on the jack screws should move the circle. Excessive torque on these screws will damage the ends of the screws.

5. When the circle is tight against the front supports, snug 2 of the 4 bolts on each rear support.

6. Loosen jack screws 4 turns and remove cap screws (D) holding horizontal shims. Install as many shims as will fit, without forcing, in gap between rear circle support and welded block. Use shims from the other side of the welded block.

7. Loosen the 4 previously snugged cap screws.

8. Tighten cap screws through horizontal adjustment shims.

9. Measure clearance between each rear circle support and circle ring. The sum of these clearances should not exceed 0.06 in. (1.5 mm).

10. Tighten all rear support bolts (8).

11. Be sure the wear surfaces on the circle have been coated with a thin coating of grease and the circle turns without binding.

Circle adjustments required Yes No

If yes, explain \_\_\_\_\_  
 \_\_\_\_\_  
 \_\_\_\_\_  
 \_\_\_\_\_  
 \_\_\_\_\_

### 19. Indicator Lights and Gauges

When operating the grader, check all gauges to see if they are operational and indicator hands are responsive.

Indicator lights should go on with engine off and key on. This checks light bulbs and wires. (To check the brake light the brake accumulator must be discharged.)

Gauges operational Yes No

If no, explain malfunction \_\_\_\_\_  
 \_\_\_\_\_  
 \_\_\_\_\_

### 20. Transmission Operation

The motor grader is equipped with a powershift transmission. It has eight forward and four reverse speeds. Check transmission operation by shifting through all gears.

Transmission operational Yes No

If no, explain \_\_\_\_\_  
 \_\_\_\_\_  
 \_\_\_\_\_

### 21. Charging System

When the motor grader is running and the alternator light is not lit, the charging system is in proper working condition.

Charging system operational Yes No

If no, explain malfunction \_\_\_\_\_  
 \_\_\_\_\_  
 \_\_\_\_\_

### 22. Cylinder Ball and Socket Assemblies

The ball and socket assemblies on the lift cylinder rod ends and on the circle side-shift cylinder have shims which may be removed to compensate for wear.

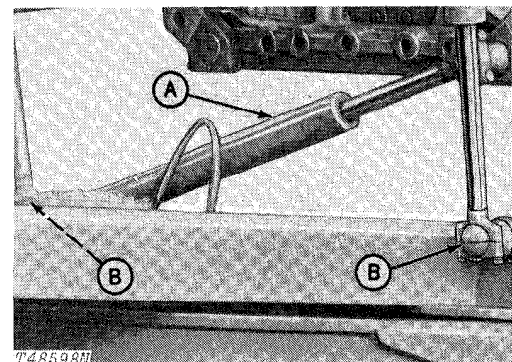

A—Circle Side-Shift Cylinder

B—Lift Cylinder Rod Ends

Fig. 84-Cylinder Ball and Socket

Check looseness of sockets by lowering the blade to the ground and operating the cylinder back and forth without load. If movement exceeds 0.03 inch (0.8 mm), remove corresponding amounts of shims.

**NOTE:** Do not allow ball to bind in the socket.

Socket looseness OK Yes No  
 If no, number of shims removed \_\_\_\_\_



**Suggest:**

**If the above button click is invalid.**

**Please download this document**

**first, and then click the above link**

**to download the complete manual.**

**Thank you so much for reading**

### 23. Moldboard Retainers

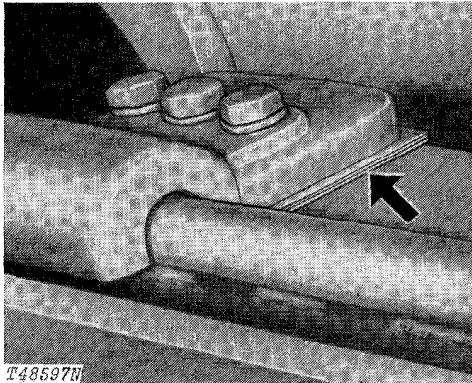
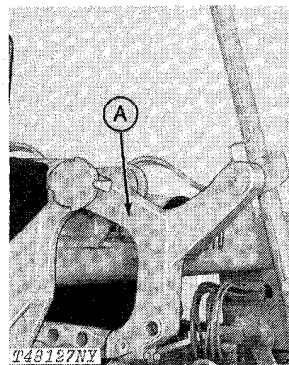

Fig. 85-Blade Side-Shift Rail Shims

The top two guides on the blade side-shift rail have shims which may be removed to compensate for wear. Check looseness between guides and rail by slightly raising and lowering the blade to the ground. If excessive looseness is noticed, remove shims accordingly.

Shims removed	Yes	No
If yes, indicate amount	_____	_____

### 24. Lift Arm Locking Pin Indicator Light and Indicator Plate



A—Lift Arm

Fig. 86-Lift Arm

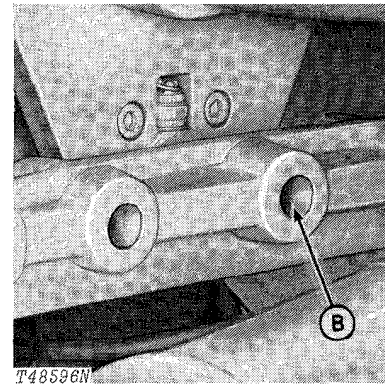

B—Lift Arm Locking Pin

Fig. 87-Lift Arm Locking Pin

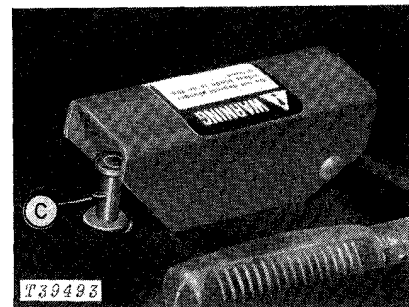

C—Lift Arm Locking Pin Plunger

Fig. 88-Lift Arm Locking Pin Plunger

When the locking pin plunger (C) is depressed the locking pin (B) should retract from hole in the lift arm (A). The lift arms may have to be "rocked" slightly (using the lift cylinders) to unload the locking pin. The indicator light on the instrument panel should come on as the locking pin retracts.

When the locking pin plunger is released the locking pin should go back into the hole in the lift arm. The indicator light should go off when pin is in hole.

The switch controlling the indicator light is mounted in the locking pin housing. It senses the taper on the locking pin, which slides under it.

Visually check if pin is in hole when light is out. Also check if the locking pin plunger travels freely.

With the blade lift arm in the horizontal position (locking pin in the center hole) the pointer attached to the lift arm should line up with the center positioning hole in the indicator plate.

**<https://www.ebooklibonline.com>**

Hello dear friend!

Thank you very much for reading.

Enter the link into your browser.

The full manual is available for immediate download.

**<https://www.ebooklibonline.com>**