

JOHN DEERE
WORLDWIDE COMMERCIAL & CONSUMER
EQUIPMENT DIVISION

Walk-Behind Rotary Mower
JA62

OMGX21823 E4

OPERATOR'S MANUAL



JOHN DEERE

North American Version
Litho in U.S.A.

INTRODUCTION

Thank You for Purchasing a John Deere Product

We appreciate having you as a customer and wish you many years of safe and satisfied use of your machine.

Using Your Operator's Manual

This manual is an important part of your machine and should remain with the machine when you sell it.

Reading your operator's manual will help you and others avoid personal injury or damage to the machine.

Information given in this manual will provide the operator with the safest and most effective use of the machine.

Knowing how to operate this machine safely and correctly will allow you to train others who may operate this machine.

If you have an attachment, use the safety and operating information in the attachment operator's manual along with the machine operator's manual to operate the attachment safely and correctly.

This manual and safety signs on your machine may also be available in other languages (see your authorized dealer to order).

Sections in your operator's manual are placed in a specific order to help you understand all the safety messages and learn the controls so you can operate this machine safely. You can also use this manual to answer any specific operating or servicing questions. A convenient index located at the end of this book will help you to find needed information quickly.

The machine shown in this manual may differ slightly from your machine, but will be similar enough to help you understand our instructions.

RIGHT-HAND and LEFT-HAND sides are determined by facing in the direction the machine will travel when going forward. When you see a broken line (-----), the item referred to is hidden from view.

Before delivering this machine, your dealer performed a predelivery inspection to ensure best performance.

Special Messages

Your manual contains special messages to bring attention to potential safety concerns, machine damage as well as helpful operating and servicing information. Please read all the information carefully to avoid injury and machine damage.



CAUTION: Avoid injury! This symbol and text highlight potential hazards or death to the operator or bystanders that may occur if the hazards or procedures are ignored.

IMPORTANT: Avoid damage! This text is used to tell the operator of actions or conditions that might result in damage to the machine.

NOTE: General information is given throughout the manual that may help the operator in the operation or service of the machine.

Attachments for Your Machine

There's a John Deere attachment or kit to make your new machine perform more tasks or be more versatile, whether your machine is a lawn tractor or compact utility tractor or a utility vehicle.

You can check out the entire line of attachments for your machine at JohnDeere.com or ask your John Deere dealer. From aerators to electric lift kits to tillers, there's a John Deere attachment or kit to fill every need.

CALIFORNIA Proposition 65 Warning



Warning: The Engine Exhaust from this product contains chemicals known to the State of California to cause cancer, birth defects or other reproductive harm.

PRODUCT IDENTIFICATION

Record Identification Numbers

21-Inch Walk-Behind Rotary Mowers

JA62 PIN (200001-)

If you need to contact an Authorized Service Center for information on servicing, always provide the product model and serial number.

You will need to locate the model and serial number for the machine and for the engine of your machine and record the information in the spaces provided below.



MX31684

DATE OF PURCHASE:

DEALER NAME:

DEALER PHONE:

PRODUCT IDENTIFICATION NUMBER (A):

ENGINE SERIAL NUMBER (B):

<https://www.ebooklibonline.com>

Hello dear friend!

Thank you very much for reading.

Enter the link into your browser.

The full manual is available for immediate download.

<https://www.ebooklibonline.com>

TABLE OF CONTENTS

Safety Labels	1
Safety	4
Operating	8
Replacement Parts	15
Service Intervals	16
Service	17
Troubleshooting	25
Storage	27
Assembly	29
Specifications	32
Warranty	33
Index	35

All information, illustrations and specifications in this manual are based on the latest information at the time of publication. The right is reserved to make changes at any time without notice.

COPYRIGHT© 2004

Deere & Co.

John Deere Worldwide Commercial and Consumer Equipment Division

All rights reserved

Previous Editions

COPYRIGHT© 1997, 1998, 2000, 2002, 2003

OMGX21823 E4 - English

SAFETY LABELS

Understanding The Machine Safety Labels



Safety-Alert Symbol

The machine safety labels shown in this section are placed in important areas on your machine to draw attention to potential safety hazards.

On your machine safety labels, the words DANGER, WARNING, and CAUTION are used with this safety-alert symbol. DANGER identifies the most serious hazards.

The operator's manual also explains any potential safety hazards whenever necessary in special safety messages that are identified with the word, CAUTION, and the safety-alert symbol.

DANGER



MX31684, M73170

ROTATING BLADE

DO NOT PUT HANDS OR FEET UNDER OR INTO MOWER WHEN ENGINE IS RUNNING

DANGER



MX31684, M73171

KEEP HANDS and FEET AWAY

CUTTING BLADES

WARNING



MX31684, MX4878

- Read and follow Operating Instructions before running engine.
- Gasoline is flammable. Allow engine to cool at least 2 minutes before refueling.
- Engines emit carbon monoxide, DO NOT run in enclosed area.

SAFETY LABELS

DANGER



MX31684, GX21565

ROTATING BLADE

Stop engine before lifting door and clearing discharge

THROWN OBJECTS

Do not lift or block door open with blade engaged

Do not mow without grass bag, side discharge chute or mulch plug in place

WARNING



MX31684, GC00489

Avoid serious injury or death

- Read the Owner's Manual.

- Go across slopes, not up and down.
- Do not mow when children or others are around.
- Look down and behind before and while mowing backwards.
- Remove objects that could be thrown by the blade.
- Keep safety devices in place and working.

CAUTION

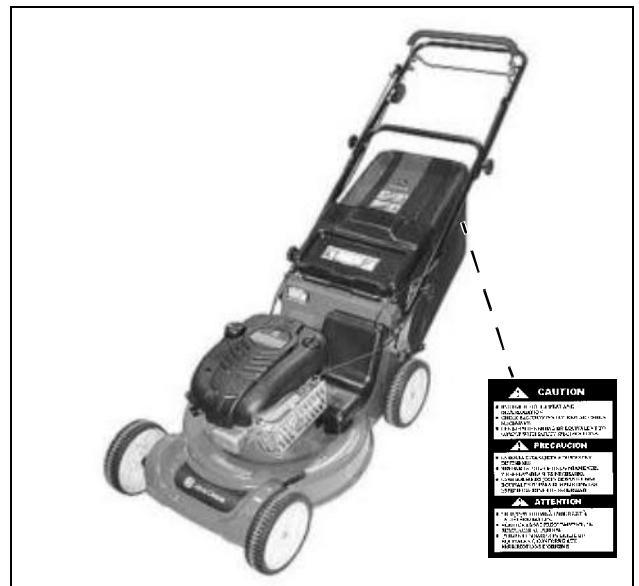

MX31684, M96543

- BAG IS SUBJECT TO WEAR AND DETERIORATION.
- CHECK BAG FREQUENTLY. REPLACE WHEN NECESSARY.
- USE JOHN DEERE BAG OR EQUIVALENT TO COMPLY WITH SAFETY SPECIFICATIONS.

Emission Control System Certification Label

NOTE: Tampering with emission controls and components by unauthorized personnel may result in severe fines or penalties. Emission controls and components can only be adjusted by EPA and/or CARB authorized service centers. Contact your John Deere Commercial and Consumer Equipment Retailer concerning emission controls and component questions.

The presence of an emissions label signifies that the engine has been certified with the United States Environmental Protection Agency (EPA) and/or California Air Resources Board (CARB).

The emissions warranty applies only to those engines

SAFETY LABELS

marketed by John Deere that have been certified by the EPA and/or CARB; and used in the United States and Canada in off-road mobile equipment.

Emission Compliance Period

If your engine has the emission compliance category listed on the emission control system certification or air index label, this indicates the number of operating hours for which the engine has been certified to meet EPA and/or CARB emission requirements. The following table provides the engine compliance period in hours associated with the category found on the certification label.

Agency	Category	Hours
EPA	C	250
EPA	B	500
EPA	A	1000
CARB	Moderate	125
CARB	Intermediate	250
CARB	Extended	500

Certification

Your mower has been certified by an independent laboratory for compliance with American National Standard B-71.1, "Safety Specifications" for Power Lawn Mowers, Lawn and Garden Tractors, and Lawn Tractors.

SAFETY

Operating Safely

- This cutting machine is capable of amputating hands and feet and throwing objects. Failure to observe the following safety instructions could result in serious injury or death.
- Read, understand and follow all instructions on the machine and in the manual before starting. Be thoroughly familiar with the controls and the proper use of the machine.
- Do not put hands or feet near or under the machine. Keep clear of the discharge opening at all times.
- Only allow responsible adults, who are familiar with the instructions, to operate this machine.
- Clear the area of objects such as rocks, toys, wire, and similar items which could be thrown by the blade. Stay behind the handle when the engine is running.
- Be sure the area is clear of bystanders before operating. Stop machine if anyone enters the area.
- Do not operate the mower barefooted or while wearing sandals. Always wear substantial footwear.
- Do not pull machine backward unless absolutely necessary. Always look down and behind before and while mowing backward.
- Never direct discharged material toward anyone. Avoid discharging material against a wall or obstruction. Material may ricochet back toward the operator. Stop the blade when crossing gravel surfaces.
- Do not operate machine without the entire grasscatcher, discharge guard, rear guard, or other safety protective devices in place and working. Never operate with the discharge deflector raised, removed, or altered, unless using a grass catcher.
- Never leave a running machine unattended.
- Stop the engine and wait until the blade comes to complete stop before cleaning the machine, removing grasscatcher, or unclogging the discharge chute.
- Operate machine only in daylight or good artificial light.
- Do not operate the mower while under the influence of alcohol or drugs.
- Never operate mower in wet grass. Always be sure of your footing. Walk; never run.
- Disengage the drive system, if so equipped, before starting the engine.
- If the machine should start to vibrate abnormally, stop the engine and check for the cause immediately. Vibration is generally a warning of trouble.
- Always wear safety goggles or safety glasses with side shields when operating mower.

- See manufacturer's instructions for proper operation and installation of accessories. Only use accessories approved by the manufacturer.
- Inspect machine before you operate. Be sure hardware is tight. Repair or replace damaged, badly worn, or missing parts. Make any necessary adjustments before you operate.
- Before using, always visually inspect to see that the blades, blade bolts and the mower assembly are not worn and damaged. Replace worn and damaged blades as needed.
- Keep safety labels visible when installing accessories and attachments.

Using a Spark Arrestor

The engine in this machine is not equipped with a spark arrestor muffler. It is a violation of California Public Resource Code Section 4442 to use or operate this engine on or near any forest-covered, brush-covered or grass-covered land unless the exhaust system is equipped with a spark arrestor meeting any applicable local or state laws. Other states or federal areas may have similar laws.

A spark arrestor for your machine may be available from your authorized dealer. An installed spark arrestor must be maintained in good working order by the operator.

Checking Mowing Area

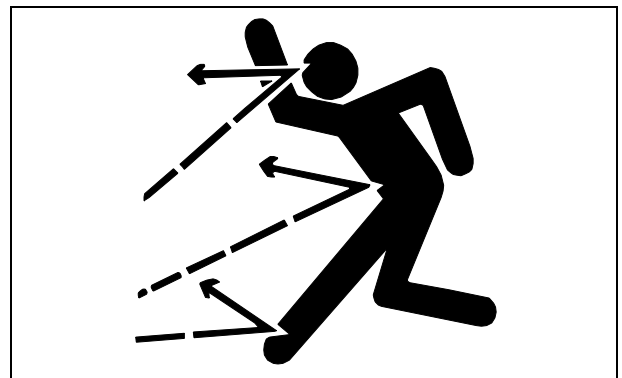

MIF

- Clear mowing area of objects that might be thrown. Keep people and pets out of mowing area.
- Low-hanging branches and similar obstacles can injure the operator or interfere with mowing operation. Before mowing, identify potential obstacles such as low-hanging branches, and trim or remove those obstacles.
- Study mowing area. Set up a safe mowing pattern. Do not mow where traction or stability is doubtful.

SAFETY

Rotating Blades are Dangerous - Protect Children and Prevent Accidents

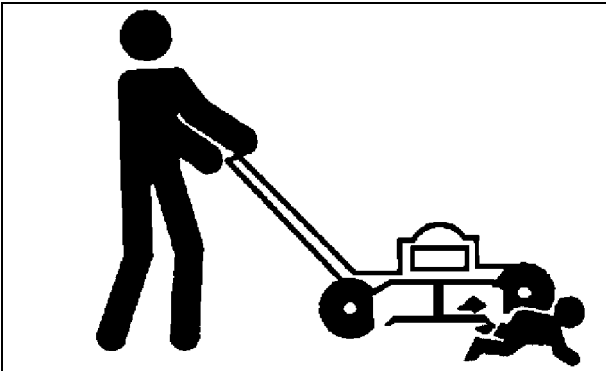

M61473

Protect Children:

- Tragic accidents can occur if the operator is not alert to the presence of children. Children are often attracted to lawn-mowing machines and mowing activity. Stay alert to the presence of children. Never assume that children will remain where you last saw them.
- Keep children indoors, out of the mowing area, and in the watchful eye of a responsible adult, other than the operator, when a mower is being operated.
- Be alert and turn mower off if a child enters the work area. They don't understand the dangers of rotating blades or the fact that the operator is unaware of their presence.
- Never allow a child or an untrained person operate the machine.
- Use extra care when approaching blind corners, shrubs, trees, or other objects that may block your view of a child.

Operating Safely on Slopes

- Slopes are a major factor related to slip and fall accidents which can result in severe injury. Operation on all slopes requires extra caution. If you feel uneasy on a slope, do not mow it.
- Mow across the face of slopes, never up and down. Use extreme caution when changing direction on slopes.
- Watch for holes, ruts, bumps, rocks or other hidden objects. Uneven terrain could cause a slip and fall accident. Tall grass can hide obstacles.
- Do not mow on wet grass or excessively steep slopes. Poor footing could cause a slip and fall accident.
- Do not mow near drop offs, ditches, or embankments. The operator could lose footing or balance.
- Use extra care with grasscatchers. These can change the stability of the machine. Do not use grasscatcher on

steep slopes.

Wear Appropriate Clothing

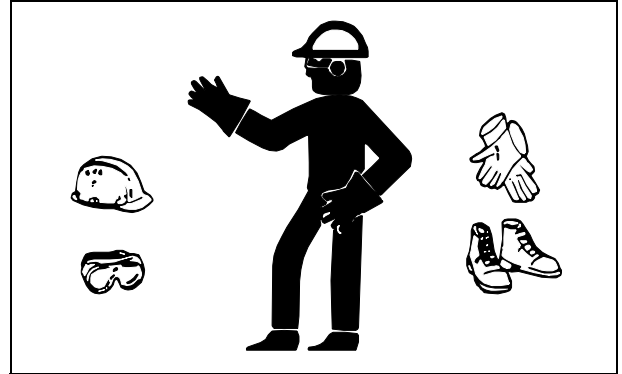

- Always wear safety goggles or safety glasses with side shields when operating the machine.
- Wear close fitting clothing and safety equipment appropriate for the job.
- While mowing, always wear substantial footwear and long trousers. Do not operate the equipment when barefoot or wearing open sandals.
- Wear a suitable protective device such as earplugs. Loud noise can cause impairment or loss of hearing.

Practice Safe Maintenance



MIF

- Only qualified, trained adults should service this machine. Understand service procedure before doing work.
- Never operate machine in a closed area where dangerous carbon monoxide fumes can collect.
- Keep all nuts and bolts tight, especially blade attachment bolts, to be sure the equipment is in safe working condition.
- Never tamper with safety devices. Check their proper

SAFETY

operation regularly.

- Keep machine free of grass, leaves or other debris build-up. Clean up oil or fuel spillage and remove any fuel-soaked debris. Allow the machine to cool before storing.
- If you strike a foreign object, stop and inspect the machine. Repair, if necessary, before restarting.
- Never make adjustments or repairs with the engine running. Wait for all movement to stop before adjusting, cleaning or repairing. Disconnect the spark plug wire, and ground against the engine to prevent accidental starting.
- Check grass catcher components and the discharge guard frequently and replace with manufacturer's recommended parts, when necessary. Grass catcher components are subject to wear, damage, and deterioration which could expose moving parts or allow objects to be thrown.
- Mower blades are sharp. Wrap the blade or wear gloves, and use extra care when servicing them. Only replace blades. Never straighten or weld them.
- Do not change the governor setting or overspeed the engine.
- Maintain or replace safety and instruction labels, as necessary.
- Keep hands, feet, clothing, jewelry, and long hair away from any moving parts, to prevent them from getting caught.
- Stop and inspect the equipment if you strike an object. Repair, if necessary, before restarting.
- Never attempt to make wheel height adjustments while the engine is running.
- Keep all parts in good condition and properly installed. Fix damage immediately. Replace worn or broken parts.

Prevent Fires

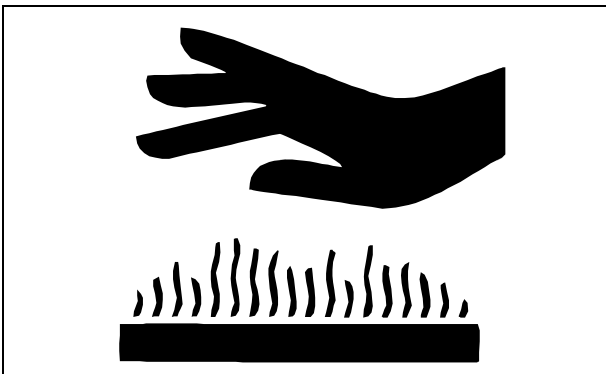

- Remove grass and debris from engine compartment

and muffler area, before and after operating machine, especially after mowing or mulching in dry conditions.

- Empty the grasscatcher completely before storing.
- Always shut off fuel when storing or transporting machine, if the machine has a fuel shutoff.
- Do not store machine near an open flame or source of ignition, such as a water heater or furnace.

Handling Fuel Safely

To avoid personal injury or property damage, use extreme care in handling fuel. Fuel is extremely flammable and fuel vapors are explosive:

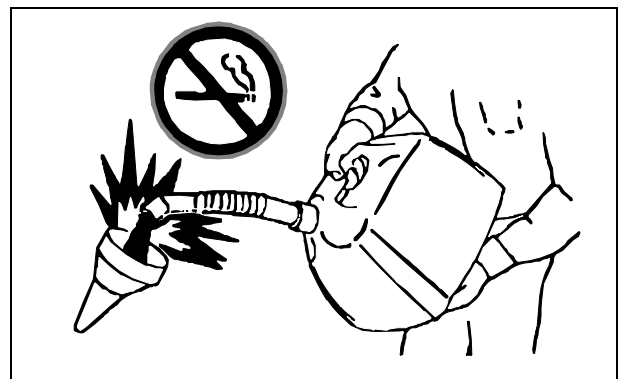

- Extinguish all cigarettes, cigars, pipes, and other sources of ignition.
- Use only an approved fuel container. Use only non-metal, portable fuel containers approved by the Underwriter's Laboratory (U.L.) or the American Society for Testing & Materials (ASTM). If using a funnel, make sure it is plastic and has no screen or filter.
- Never remove the fuel tank cap or add fuel with the engine running. Allow engine to cool before refueling.
- Never add fuel to or drain fuel from the machine indoors. Move machine outdoors and provide adequate ventilation.
- Clean up spilled fuel immediately. If fuel is spilled on clothing, change clothing immediately. If fuel is spilled near machine, do not attempt to start the engine but move the machine away from the area of spillage. Avoid creating any source of ignition until fuel vapors have dissipated.
- Never store the machine or fuel container where there is an open flame, spark, or pilot light such as on a water heater or other appliance.

SAFETY

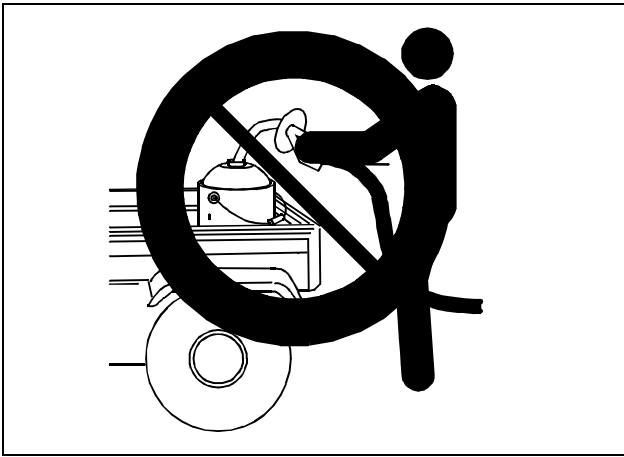

and batteries, can harm the environment and people:

- Do not use beverage containers for waste fluids - someone may drink from them.
- See your local Recycling Center or authorized dealer to learn how to recycle or get rid of waste products.
- A Material Safety Data Sheet (MSDS) provides specific details on chemical products: physical and health hazards, safety procedures, and emergency response techniques. The seller of the chemical products used with your machine is responsible for providing the MSDS for that product.

- Prevent fire and explosion caused by static electric discharge. Static electric discharge can ignite fuel vapors in an ungrounded fuel container.
- Never fill containers inside a vehicle or on a truck or trailer bed with a plastic liner. Always place containers on the ground away from your vehicle before fueling.
- Remove fuel-powered equipment from the truck or trailer and refuel it on the ground. If this is not possible, then refuel such equipment with a portable container, rather than from a fuel dispenser nozzle.
- Keep the nozzle in contact with the rim of the fuel tank or container opening at all times until the fueling is complete. Do not use a nozzle lock-open device.
- Never overfill fuel tank. Replace fuel tank cap and tighten securely.
- Replace all fuel container caps securely after use.
- For gasoline engines, do not use gas with methanol. Methanol is harmful to your health and to the environment.

Handling Waste Product and Chemicals

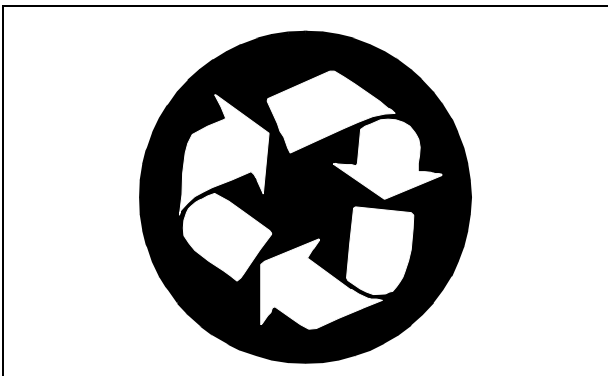

Waste products, such as, used oil, fuel, coolant, brake fluid,

OPERATING

Daily Operating Checklist

- Test safety systems.
- Check fuel level.
- Check engine oil level.
- Remove grass and debris from machine.
- Check area below machine for leaks.

Avoid Damage to Plastic and Painted Surfaces

- Do not wipe plastic parts unless rinsed first.
- Insect repellent spray may damage plastic and painted surfaces. Do not spray insect repellent near machine.
- Be careful not to spill fuel on machine. Fuel may damage surface. Wipe up spilled fuel immediately.

Avoid Damage to Aluminum Mower Deck

- Clean under mower deck to remove harmful buildup of lawn chemicals.
- Use regular water pressure to clean under deck. Do not use high pressure spray. High pressure spray may damage clutch and transmission parts.

Engine Controls



MX31686

A - Primer Bulb

Handle Controls

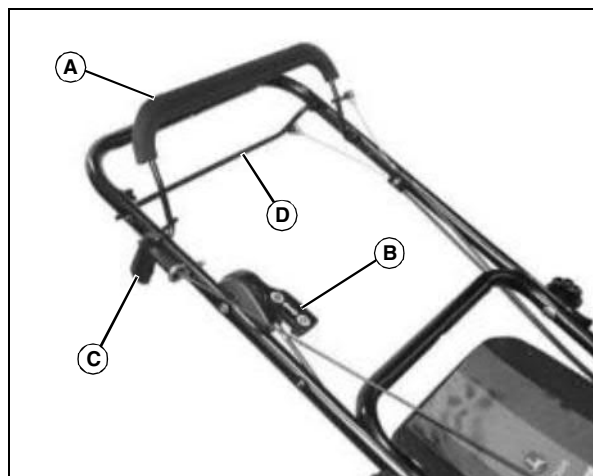

MX31685

- A - Blade/Engine Control Lever
- B - Gear Shift Lever
- C - Starter Handle
- D - Traction Clutch Lever

Cutting Height Controls

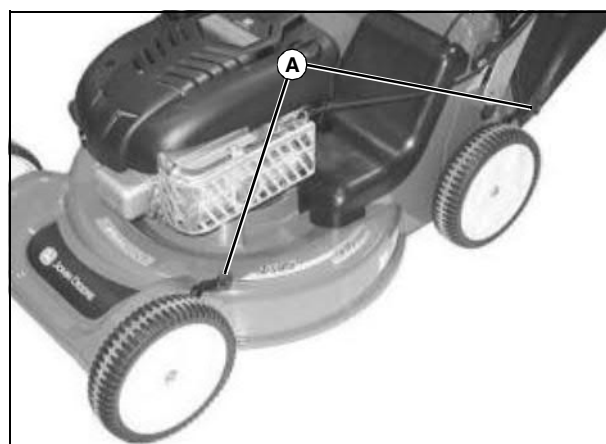

MX31687

A - Cutting Height Levers

Adjusting Cutting Height



CAUTION: Avoid injury! Before you adjust cutting height:

- Stop engine.

NOTE: Adjust both levers to same height except for lowest cutting height. This adjustment improves



Suggest:

If the above button click is invalid.

Please download this document

first, and then click the above link

to download the complete manual.

Thank you so much for reading

OPERATING

bagging and mulching performance at lowest cutting height:

- Put front wheel levers in the first rear notch: 25 mm (1 in.).
- Put rear wheel levers in the second rear notch: 38 mm (1-1/2 in.).

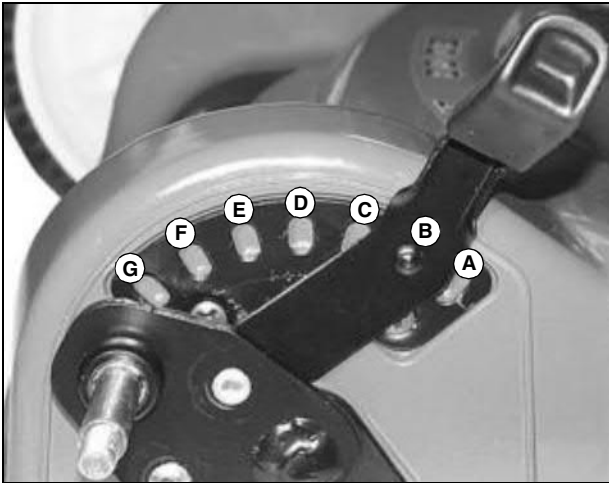

Picture Note: Left front shown above

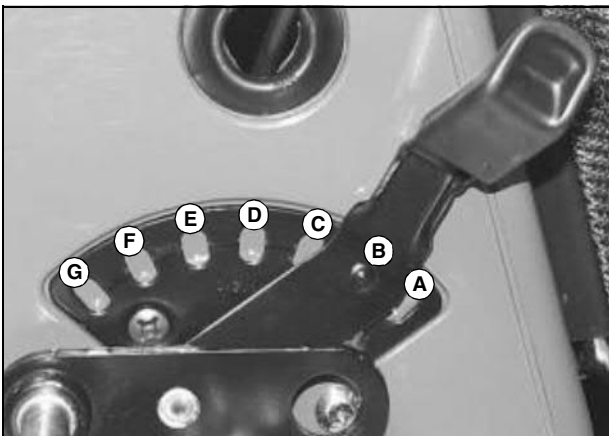

Picture Note: Left rear shown above

Key	Cutting Height Adjustments In mm (Inches)
(A)	25 mm (1 in.)
(B)	38 mm (1-1/2 in.)
(C)	50 mm (2 in.)
(D)	64 mm (2-1/2 in.)
(E)	75 mm (3 in.)
(F)	90 mm (3-1/2 in.)

Key	Cutting Height Adjustments In mm (Inches)
(G)	102 mm (4 in.)

Moving wheel levers:

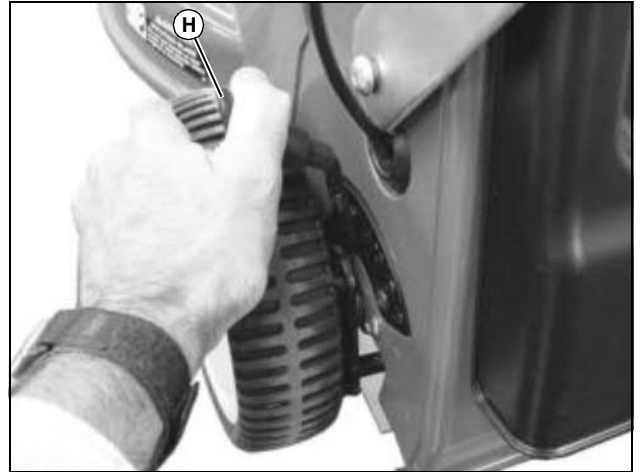

MX31694

1. Rear wheels have lift assist springs and can be adjusted with one hand. Use left hand and pull lever (H) outward, as shown, move lever to desired position, and release lever to lock in notch.
2. For front wheels, push down slightly on handlebar to take some weight off front wheels. Move lever with left hand, the same way as with rear wheels, and move lever to desired position.

Adjusting Handle Height

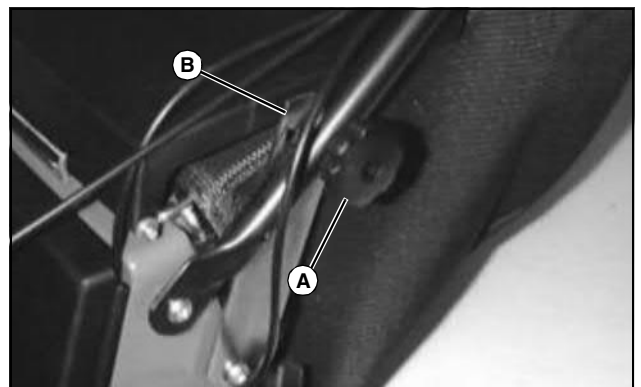

M88841

1. Remove knob (A) and bolt from each side.
2. Move handle to desired height.

<https://www.ebooklibonline.com>

Hello dear friend!

Thank you very much for reading.

Enter the link into your browser.

The full manual is available for immediate download.

<https://www.ebooklibonline.com>