

JOHN DEERE
WORLDWIDE COMMERCIAL & CONSUMER
EQUIPMENT DIVISION

21-Inch Walk-Behind Rotary Mowers
JA60 and JA62

OMGC00514 I0

OPERATOR'S MANUAL



North American Version
Litho in U.S.A.

INTRODUCTION

Thank You for Purchasing a John Deere Product

We appreciate having you as a customer and wish you many years of safe and satisfied use of your machine.

Using Your Operator's Manual

This manual is an important part of your machine and should remain with the machine when you sell it.

Reading your operator's manual will help you and others avoid personal injury or damage to the machine. Information given in this manual will provide the operator with the safest and most effective use of the machine. Knowing how to operate this machine safely and correctly will allow you to train others who may operate this machine.

This manual and safety signs on your machine may also be available in other languages (see your John Deere dealer to order).

Sections in your operator's manual are placed in a specific order to help you understand all the safety messages and learn the controls so you can operate this machine safely. You can also use this manual to answer any specific operating or servicing questions. A convenient index located at the end of this book will help you to find needed information quickly.

The machine shown in this manual may differ slightly from your machine, but will be similar enough to help you understand our instructions.

RIGHT-HAND and LEFT-HAND sides are determined by facing in the direction the machine will travel when going forward. When you see a broken line arrow (----->), the item referred to is hidden from view.

Before delivering this machine, your dealer performed a predelivery inspection to ensure best performance.

Special Messages

Your manual contains special messages to bring attention to potential safety concerns, machine damage as well as helpful operating and servicing information. Please read all the information carefully to avoid injury and machine damage.

IMPORTANT: Avoid damage! This text is used to tell the operator of actions or conditions that might result in damage to the machine.

NOTE: General information is given throughout the manual that may help the operator in the operation or service of the machine.

CALIFORNIA Proposition 65 Warning

Warning: The Engine Exhaust from this product contains chemicals known to the State of California to cause cancer, birth defects or other reproductive harm.



CAUTION: Avoid injury! This symbol and text highlight potential hazards or death to the operator or bystanders that may occur if the hazards or procedures are ignored.

PRODUCT IDENTIFICATION

Record Identification Numbers

21-Inch Walk-Behind Rotary Mowers

JA60 and JA62 PIN (100001-)

If you need to contact an Authorized Service Center for information on servicing, always provide the product model and serial number.

You will need to locate the model and serial number for the machine and for the engine of your machine and record the information in the spaces provided below.

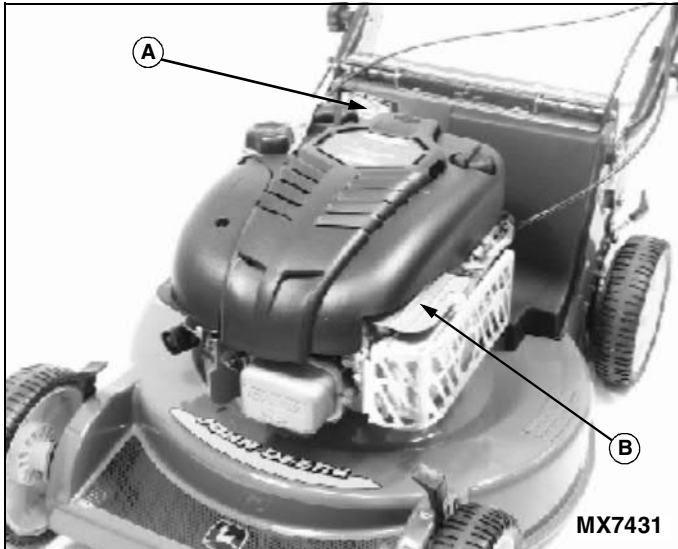

DATE OF PURCHASE:

DEALER NAME:

DEALER PHONE:

PRODUCT IDENTIFICATION NUMBER (A):

ENGINE SERIAL NUMBER (B):

<https://www.ebooklibonline.com>

Hello dear friend!

Thank you very much for reading.

Enter the link into your browser.

The full manual is available for immediate download.

<https://www.ebooklibonline.com>

TABLE OF CONTENTS

Safety	1
Operating.....	6
Replacement Parts.....	12
Service Intervals.....	13
Service	14
Troubleshooting	22
Storing Machine.....	24
Assembly	26
Specifications	28
Warranty	30
Index.....	34

All information, illustrations and specifications in this manual are based on the latest information at the time of publication. The right is reserved to make changes at any time without notice.

COPYRIGHT© 2000
Deere & Co.

John Deere Worldwide Commercial and
Consumer Equipment Division
Horicon, WI

All rights reserved
Previous Editions
COPYRIGHT© 1998, 1997

OMGC00514 I0 - English

SAFETY

Understanding The Machine Safety Labels

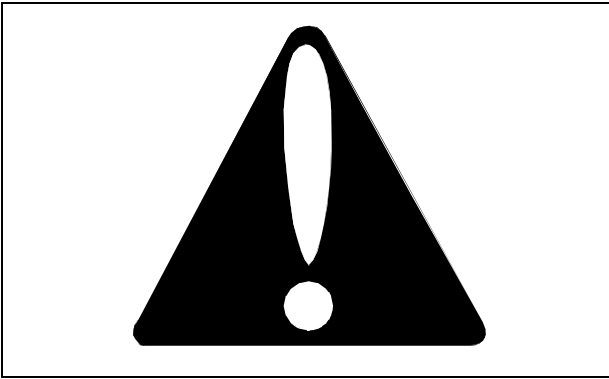

The machine safety labels shown in this section are placed in important areas on your machine to draw attention to potential safety hazards.

On your machine safety labels, the words **DANGER**, **WARNING**, and **CAUTION** are used with this safety-alert symbol, (▲). **DANGER** identifies the most serious hazards.

The operator's manual also explains any potential safety hazards whenever necessary in special safety messages that are identified with the word, **CAUTION**, and the safety-alert symbol, (▲).

DANGER: ROTATING BLADE

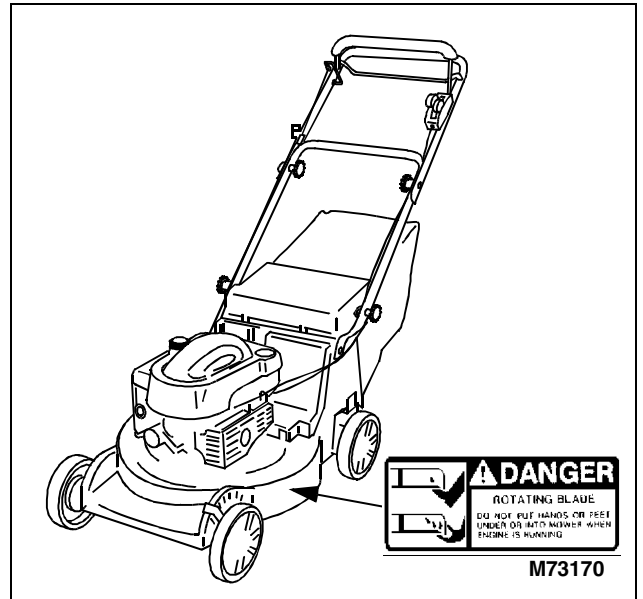

Do not put hands or feet under or into mower when engine is running

DANGER: KEEP HANDS AND FEET AWAY



Cutting blades

WARNING

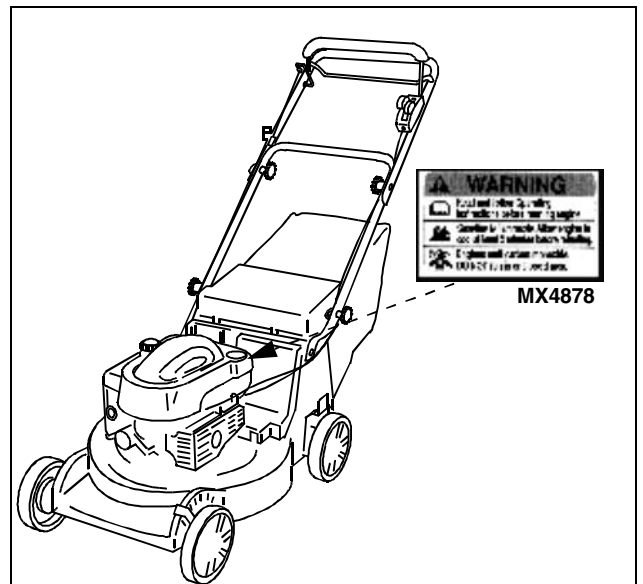

- Read and follow Operating Instructions before running engine.
- Gasoline is flammable. Allow engine to cool at least 2 minutes before refueling.
- Engines emit carbon monoxide, Do not run in enclosed area.

SAFETY

DANGER

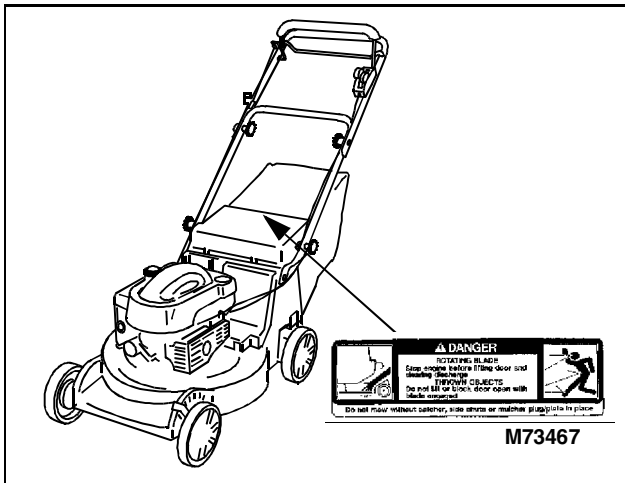

ROTATING BLADE

- Stop engine before lifting door and clearing discharge.

THROWN OBJECTS

- Do not lift or block door open with blade engaged

Do not mow without catcher, side chute or mulcher plug/plate in place.

WARNING: AVOID SERIOUS INJURY OR DEATH

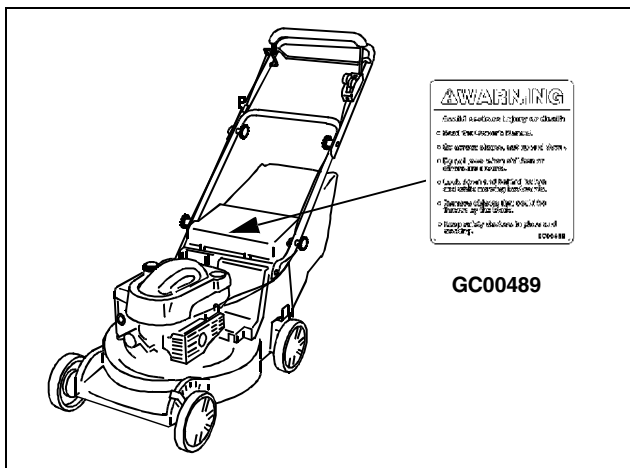

- Read the Owner's Manual.
- Go across slopes, not up and down.
- Do not mow when children or others are around.
- Look down and behind before and while mowing backwards.
- Remove objects that could be thrown by the blade.

- Keep safety devices in place and working.

CAUTION



- Bag is subject to wear and deterioration.
- Check bag frequently. Replace when necessary.
- Use John Deere bag or equivalent to comply with safety specifications.

Certification Label

This OPEI label on your mower indicates that this model has been certified by an independent laboratory for compliance with American National Standard B-71.1, "Safety Specifications" for Power Lawn Mowers, Lawn and Garden Tractors, and Lawn Tractors.

Emission Control System Certification Label

NOTE: Tampering with emission controls and components by unauthorized personnel may result in severe fines or penalties. Emission controls and components can only be adjusted by EPA and/or CARB authorized service centers. Contact your John Deere Commercial and Consumer Equipment Retailer concerning emission controls and component questions.

The presence of an emissions label signifies that the engine has been certified with the United States Environmental Protection Agency (EPA) and/or California

SAFETY

Air Resources Board (CARB).

The emissions warranty applies only to those engines marketed by John Deere that have been certified by the EPA and/or CARB; and used in the United States and Canada in off-road mobile equipment.

Emission Compliance Period

If your engine has the emission compliance category listed on the emission control system certification or air index label, this indicates the number of operating hours for which the engine has been certified to meet EPA and/or CARB emission requirements. The following table provides the engine compliance period in hours associated with the category found on the certification label.

Agency	Category	Hours
EPA	C	250
EPA	B	500
EPA	A	1000
CARB	Moderate	125
CARB	Intermediate	250
CARB	Extended	500

Operate Safely

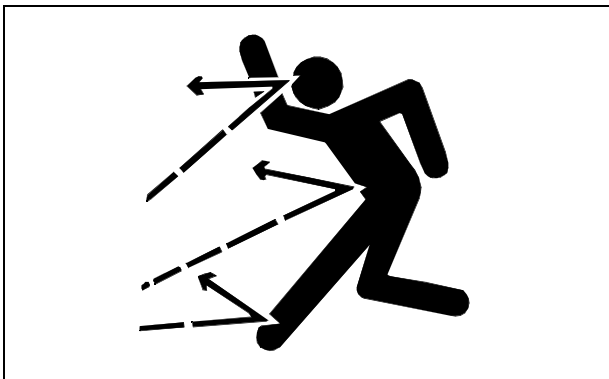

- Inspect machine before you operate. Be sure hardware is tight. Repair or replace damaged, badly worn, or missing parts. Be sure proper guards, plates, grass catcher, or other safety protective devices are in good condition and fastened in place. Make any necessary adjustments before you operate.
- Clear work area of objects that might be thrown. Keep people and pets out of the work area. Stop machine if anyone enters the area.

- If you hit an object, stop the machine and inspect it. Make repairs before you operate. Keep machine properly maintained and in good working order.
- Do not leave machine unattended when it is running.
- Only operate during daylight or with good artificial light.
- Be sure of footing. Be especially careful when you pull machine backwards with the engine running.
- Mow across a hill - not up and down. Be careful when you change direction on a slope. Do not mow excessively steep slopes.
- Do not mow wet grass. Reduced traction could cause you to slip.
- Keep a firm hold on the machine handle.
- Do not wear radio or music headphones while operating the machine. Safe operation requires your full attention.
- Do not operate mower if you are under the influence of drugs or alcohol.

Rotating Blades are Dangerous - Protect Children and Prevent Accidents

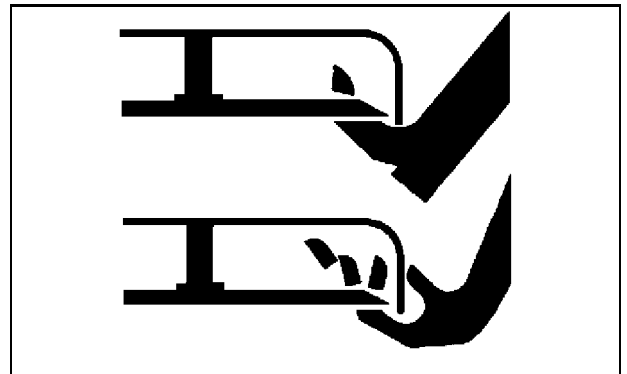
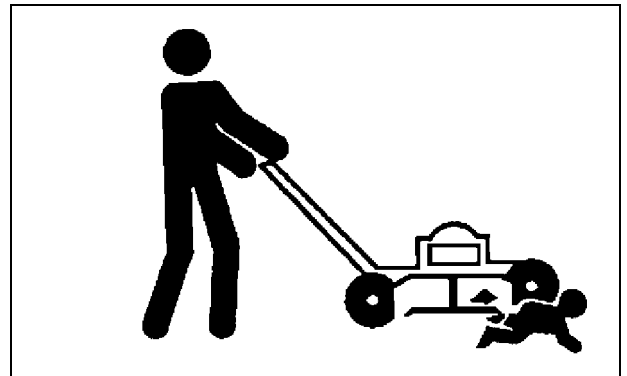

PROTECT CHILDREN:

- Never assume that children will remain where you last saw them. Children are attracted to mowing activity, stay alert to the presence of children.

SAFETY

- Keep children in the house when you are operating the machine.
- Turn machine off if a child enters the area.
- Use extra care when you come to blind corners, shrubs, trees, or other objects that may block your vision.
- Do not let children or an untrained person operate the machine.

HELP PREVENT SERIOUS OR FATAL ACCIDENTS:

- Be alert at all times, people especially children can move quickly into the area before you know it.
- Stop the blade when crossing gravel drives, walks, or roads.
- Shut off blades when you are not mowing.
- Keep hands, feet, and clothing away from rotating blades.

Wear Appropriate Clothing

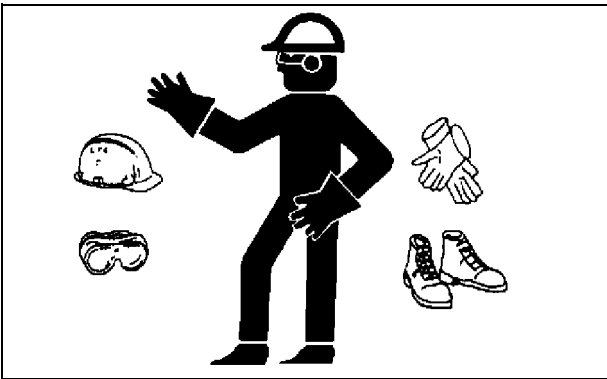

- Wear close fitting clothing and safety equipment appropriate for the job.
- Do not operate the equipment when barefoot or wearing open sandals. Always wear substantial footwear.
- Loud noise can cause impairment or loss of hearing, wear a suitable protective device such as earplugs.

Practice Safe Maintenance



- Understand service procedure before doing work. Keep area clean and dry.
- Never lubricate, service, or adjust machine while it is moving. Keep safety devices in place and in working condition. Keep hardware tight.
- To prevent them from getting caught, keep hands, feet, clothing, jewelry, and long hair away from any moving parts.
- Before servicing machine, disengage all power and stop the engine. Let engine cool.
- Securely support any machine elements that must be raised for service work.
- Keep all parts in good condition and properly installed. Fix damage immediately. Replace worn or broken parts. Remove any buildup of grease, oil, or debris.
- Unauthorized modifications to the machine may impair its function and safety.

Avoid Injury from Contacting Blade

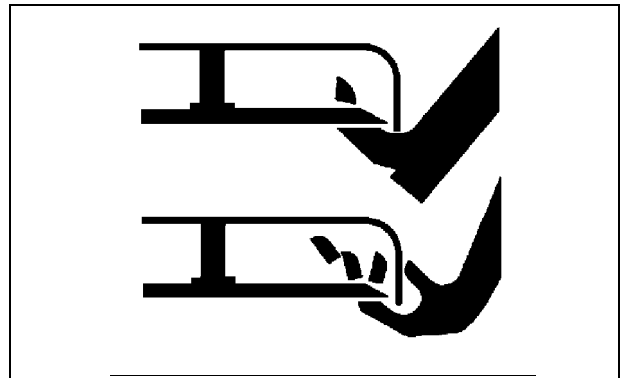

Before you unplug or adjust machine:

- Stop the engine.
- Wait for blade to Stop.
- Keep hands, feet and clothing away from blade when

SAFETY

engine is running.

Handling Waste Products

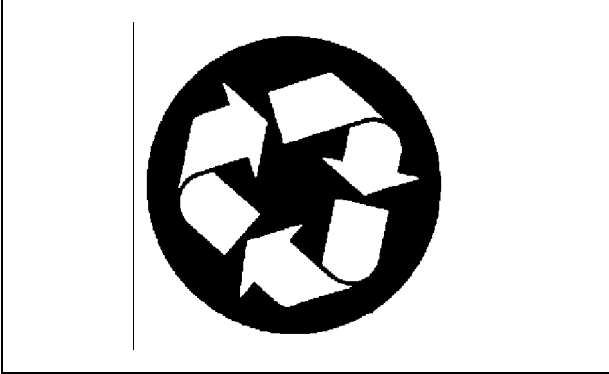

- Waste products, such as, used oil, fuel, and batteries, can harm the environment and people.
- Do not use beverage containers for waste fluids - someone may drink from them.
- See your local Recycling Center or John Deere dealer to learn how to recycle or get rid of waste products.
- A Material Safety Data Sheet (MSDS) provides specific details on chemical products: physical and health hazards, safety procedures, and emergency response techniques. See your John Deere dealer for the MSDS on chemical products used with your machine.

Handling Fuel Safely

Fuel and fuel vapors are highly flammable:

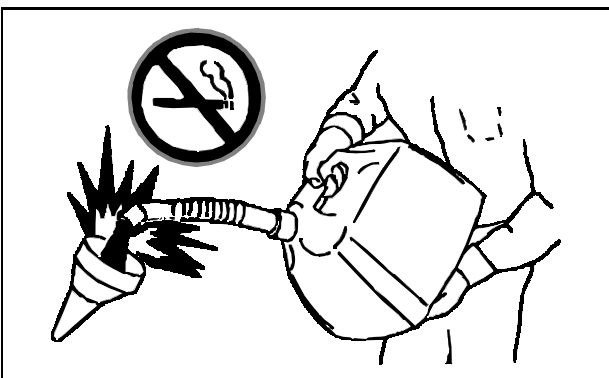

- Do not refuel machine while you smoke, when machine is near an open flame or sparks, or when engine is running. Stop engine.
- Fill fuel tank outdoors.
- Prevent fires: clean oil, grease and dirt from machine. Clean up spilled fuel immediately.

- Do not store machine with fuel in tank in a building where fumes may reach an open flame or spark.
- Prevent fire and explosion caused by static electric discharge. Use only non-metal, portable fuel containers approved by the Underwriter's Laboratory (U.L.) or the American Society for Testing & Materials (ASTM). If using a funnel, make sure it is plastic and has no screen or filter.
- Static electric discharge can ignite gasoline vapors in an ungrounded fuel container. Remove the fuel container from the bed of a vehicle or the trunk of a car and place on the ground away from the vehicle before filling. Keep nozzle in contact with container opening while filling.



- When practical, remove equipment from trailers or truck beds and refuel them on the ground. If this is not possible, use a portable, plastic fuel container to refuel equipment on a truck bed or trailer.
- Do not use methanol gasoline. Methanol is harmful to the environment and to your health.

OPERATING

Daily Operating Checklist

- Test safety systems.
- Check fuel level.
- Check engine oil level.
- Remove grass and debris from machine.
- Check area below machine for leaks.

Avoid Damage to Plastic and Painted Surfaces

- Do not wipe plastic parts unless rinsed first.
- Insect repellent spray may damage plastic and painted surfaces. Do not spray insect repellent near machine.
- Be careful not to spill fuel on machine. Fuel may damage surface. Wipe up spilled fuel immediately.

Avoid Damage to Aluminum Mower Deck

- Clean under mower deck to remove harmful buildup of lawn chemicals.
- Use regular water pressure to clean under deck. Do not use high pressure spray. High pressure spray may damage clutch and transmission parts.

Handle Controls

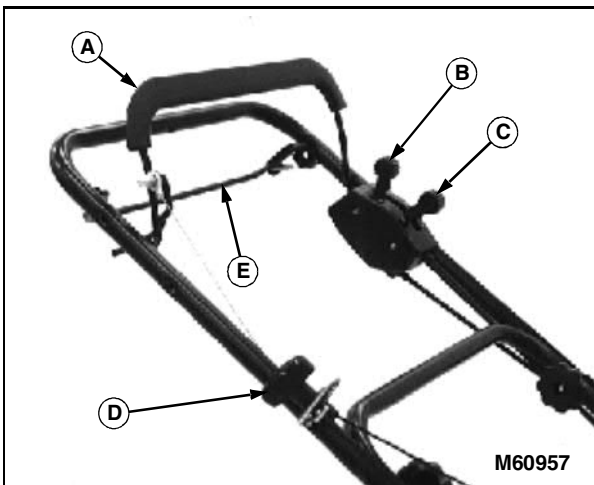

- A - Blade/Engine Control Lever**
- B - Gear Shift Lever (JA62)**
- C - Throttle Lever (JA62)**
- D - Starter Handle**
- E - Traction Clutch Lever (JA62)**



A - Throttle Lever (JA60)

Engine Controls

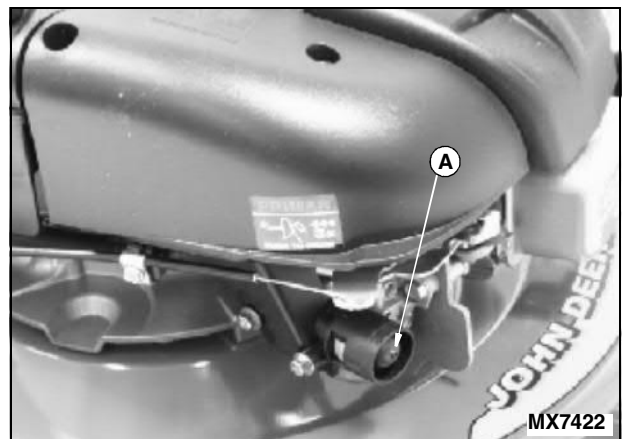

A - Primer Bulb

OPERATING

Cutting Height Controls

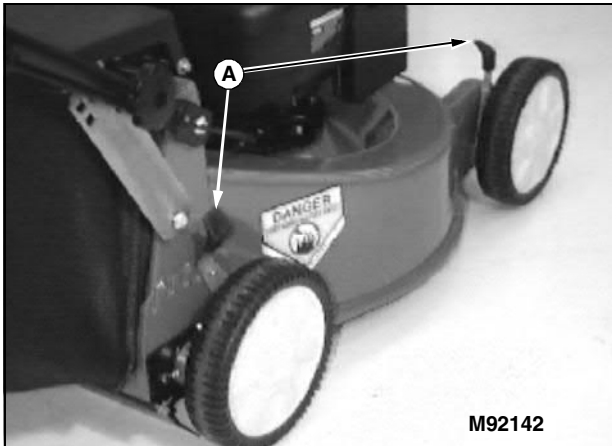

A - Cutting Height Levers

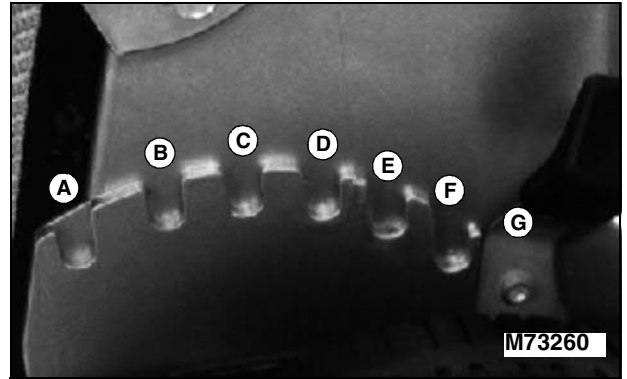

Picture Note: Right rear shown above

Adjusting Cutting Height



CAUTION: Avoid injury! Before you adjust cutting height:

- Stop engine.

NOTE: Adjust both levers to same height except for lowest cutting height. This adjustment improves mulching performance at lowest cutting height:

- Put front wheel levers in the first rear notch: 13 mm (1/2 in.).
- Put rear wheel levers in the second rear notch: 25 mm (1 in.) notch.

Key	Cutting Height Adjustments In mm (Inches)
(A)	13 mm (1/2 in.)
(B)	25 mm (1 in.)
(C)	38 mm (1-1/2 in.)
(D)	50 mm (2 in.)
(E)	64 mm (2-1/2 in.)
(F)	75 mm (3 in.)
(G)	90 mm (3-1/2 in.)

To help move rear wheel levers:

1. Lift lower handlebar slightly with one hand to take some weight off wheel.
2. Move lever to desired position with other hand.

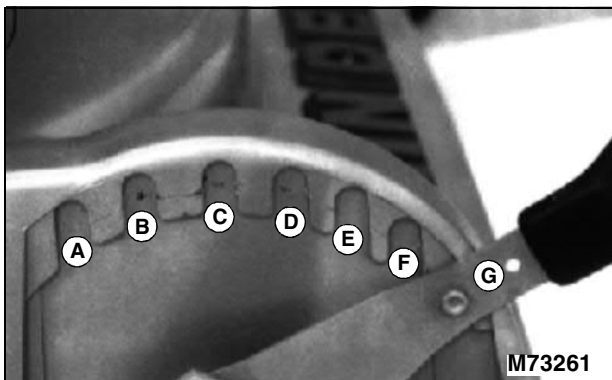

Picture Note: Right front shown above

Adjusting Handle Height

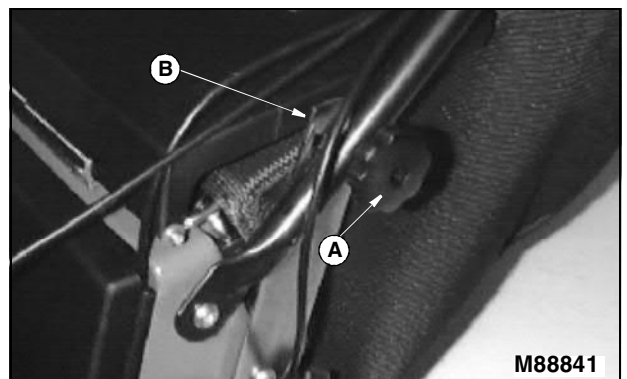

1. Remove knob (A) and bolt from each side.
2. Move handle to desired height.
3. Line up square hole in bracket (B) with hole in handle.

OPERATING

4. Install bolt through holes. Install knob.
5. Repeat Steps 2–4 on other side.

Testing Safety Systems

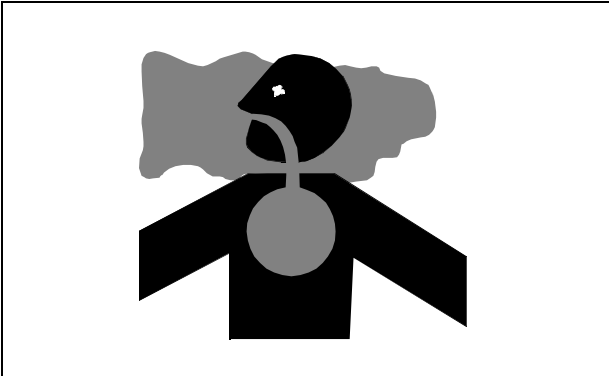

CAUTION: Avoid injury! Engine exhaust fumes contain carbon monoxide and can cause serious illness or death.

Move the vehicle to an outside area before running the engine.

Do not run an engine in an enclosed area without adequate ventilation.

- Connect a pipe extension to the engine exhaust pipe to direct the exhaust fumes out of the area.
- Allow fresh outside air into the work area to clear the exhaust fumes out.

Use the following checkout procedure to check for normal operation of machine.

If there is a malfunction during one of these procedures, do not operate machine. **See your John Deere dealer for service.**

Perform these tests in a clear open area. Keep bystanders away.

Testing Blade/Engine Control Lever

1. Start engine.
2. Release blade/engine control lever.
3. Listen for blade and engine to stop. Do not look under mower to check blade.

Result: Blade and engine should stop within three seconds. If blade and engine continue to run, there is a problem with your safety interlock circuit.

Starting Engine

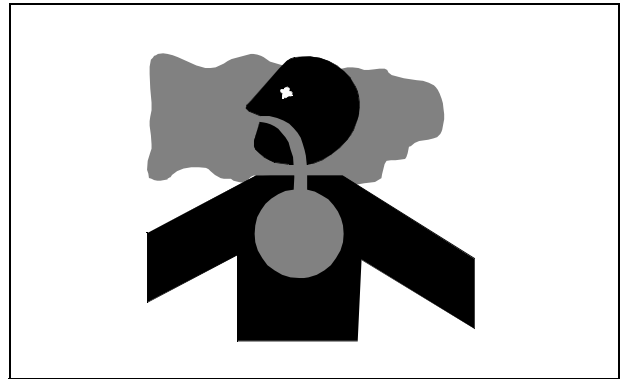

CAUTION: Avoid injury! Engine exhaust fumes can cause sickness or death. Run engine only in a ventilated area.

If you run engine in an enclosed area, remove exhaust with exhaust pipe extension, or open doors to bring in outside air.

IMPORTANT: Avoid damage! To help prevent damage to starter and band brake, do not start the engine:

- When blade is under load, such as, in heavy grass or
- When blade control lever is released.

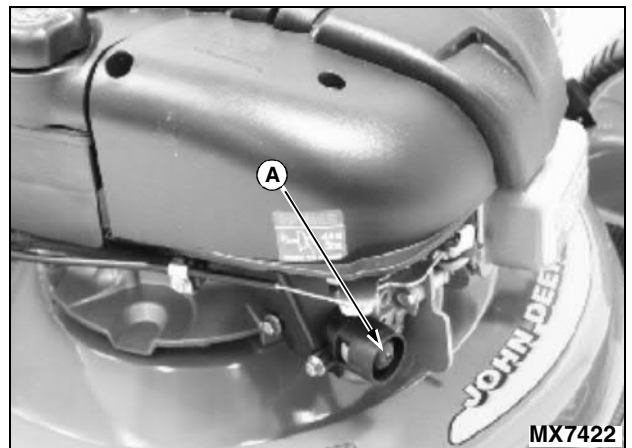

1. Prime engine by pressing primer bulb (A) three times.

OPERATING

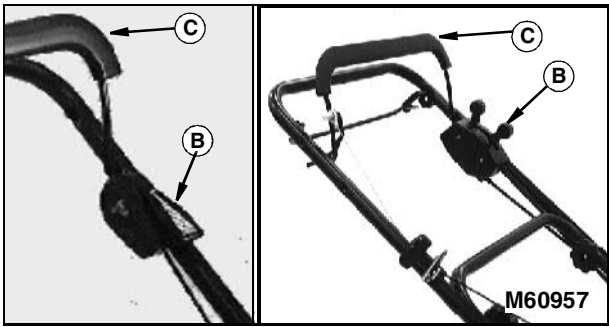

Picture Note: Model JA60 shown on left; Model JA62 shown on right

2. Move throttle lever (B) to the fast  position.
3. Hold blade/engine control lever (C) against handle.



Picture Note: JA62 shown

4. Pull starter handle (D) until you feel resistance. Then pull fast and steady.



CAUTION: Avoid injury! When engine is running, blade is turning.
Keep hands, feet and clothing away from blade.

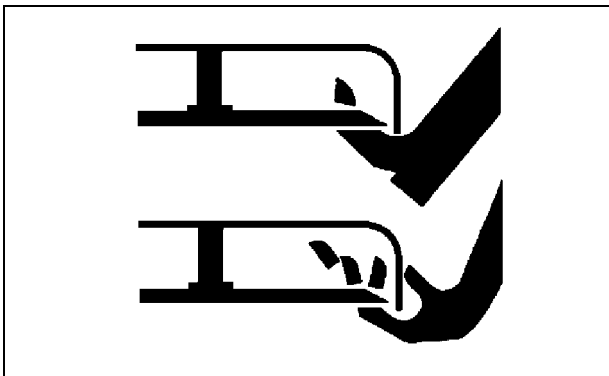

5. When engine starts, return rope slowly until handle is in

bracket.

Forward Travel (JA62)

To Travel Forward:

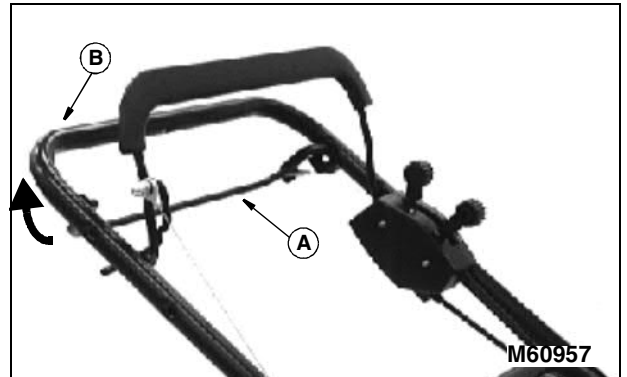

Pull and hold traction clutch lever (A) against handle (B).

To Stop Forward Travel:

Release lever (A). Release lever before you turn.

NOTE: Rear wheels will make a clicking noise when you push mower forward. This means drivetrain is operating correctly.

Travel Speeds (JA62)

- 1st Gear: 3.2 kph (2 mph)
- 2nd Gear: 5 kph (3 mph)

To change travel speeds:

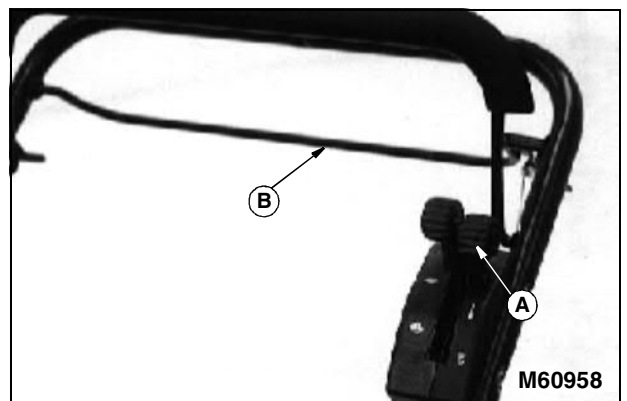

1. Stop. Move gear lever (A) to desired position:
 - 1st Gear: Move lever to rear notch as shown.
 - 2nd Gear: Move lever to forward notch.
2. Engage traction clutch lever (B).



Suggest:

If the above button click is invalid.

Please download this document

first, and then click the above link

to download the complete manual.

Thank you so much for reading

OPERATING

Stopping Engine

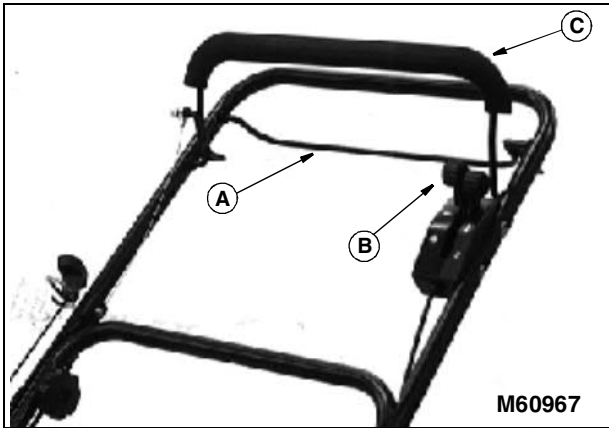

1. Release traction clutch lever (A). (JA62 models only)
2. Pull throttle lever (B) to the slow  position.
3. Release blade/engine control lever (C).



CAUTION: Avoid injury! Engine and blade must stop within 3 seconds. If not, see your John Deere dealer.

Emergency Stopping

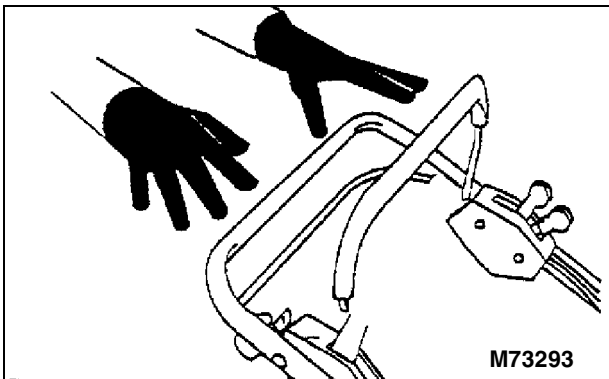

Release handle and levers:

- Mower travel will stop.
- Blade will stop.
- Engine will stop.

Using Discharge Chute (Optional)



CAUTION: Avoid injury! Do not operate mower unless grass bag, chute, or mulch plug is held in place by door. Before you empty bag, stop mower, blade and engine.

1. Stop engine. Lift and hold door.
2. Remove grass bag.

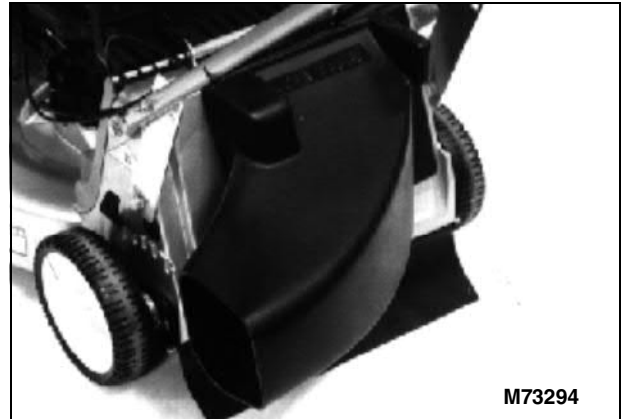

3. Install chute. Lower door to hold chute in place.

Using Grass Bag

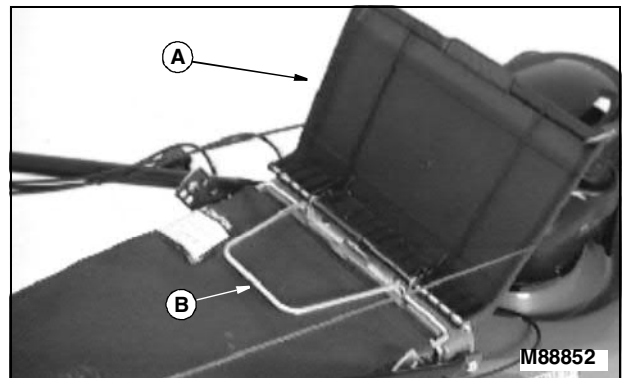

1. Lift and hold door (A).
2. Grasp handle (B). Lift bag off mower.
3. Gently lower door.

NOTE: Bag may wear and deteriorate. Check condition of bag often. Use a John Deere bag or equivalent to comply with safety specifications.

Using Mulch Plug (Optional)

See your John Deere dealer for Mulch Plug.

<https://www.ebooklibonline.com>

Hello dear friend!

Thank you very much for reading.

Enter the link into your browser.

The full manual is available for immediate download.

<https://www.ebooklibonline.com>