

JOHN DEERE
WORLDWIDE COMMERCIAL & CONSUMER
EQUIPMENT DIVISION

Riding Mowers
GX85 and SX85

OPERATOR'S MANUAL



 **WARNING:** The Engine Exhaust from this product contains chemicals known to the State of California to cause cancer, birth defects or other reproductive harm.

California Proposition 65 Warning

OMM143122 E0

North American Version
Litho in U.S.A.

INTRODUCTION

Thank You for Purchasing a John Deere Product

We appreciate having you as a customer and wish you many years of safe and satisfied use of your machine.

Using Your Operator's Manual

This manual is an important part of your machine and should remain with the machine when you sell it.

Reading your operator's manual will help you and others avoid personal injury or damage to the machine. Information given in this manual will provide the operator with the safest and most effective use of the machine. Knowing how to operate this machine safely and correctly will allow you to train others who may operate this machine.

This manual and safety signs on your machine may also be available in other languages (see your John Deere dealer to order).

Sections in your operator's manual are placed in a specific order to help you understand all the safety messages and learn the controls so you can operate this machine safely. You can also use this manual to answer any specific operating or servicing questions. A convenient index located at the end of this book will help you to find needed information quickly.

The machine shown in this manual may differ slightly from your machine, but will be similar enough to help you understand our instructions.

RIGHT-HAND and LEFT-HAND sides are determined by facing in the direction the machine will travel when going forward. When you see a broken line arrow (----->), the item referred to is hidden from view.

Before delivering this machine, your dealer performed a predelivery inspection to ensure best performance.

Special Messages

Your manual contains special messages to bring attention to potential safety concerns, machine damage as well as helpful operating and servicing information. Please read all the information carefully to avoid injury and machine damage.



CAUTION: Avoid injury! This symbol and text highlight potential hazards or death to the operator or bystanders that may occur if the hazards or procedures are ignored.

IMPORTANT: Avoid damage! This text is used to tell the operator of actions or conditions that might result in damage to the machine.

NOTE: General information is given throughout the manual that may help the operator in the operation or service of the machine.

PRODUCT IDENTIFICATION

Record Identification Numbers

Riding Mowers

GX85 and SX85

PIN (105001-)

If you need to contact an Authorized Service Center for information on servicing, always provide the product model and identification numbers.

You will need to locate the identification numbers for the product. Record the information in the spaces provided below.

DATE OF PURCHASE:

DEALER NAME:

DEALER PHONE:

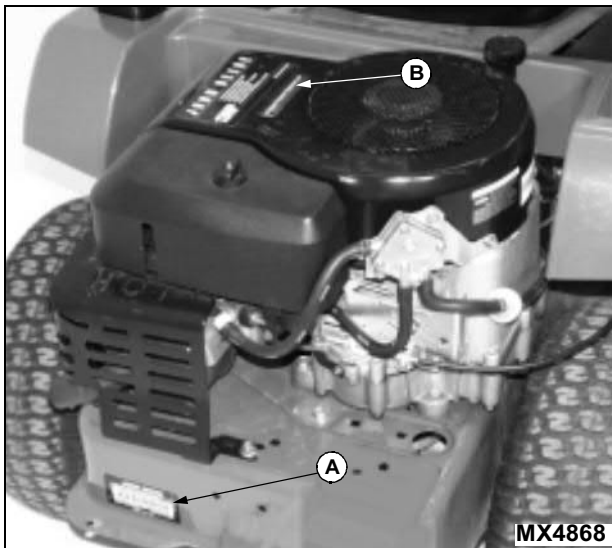

PRODUCT IDENTIFICATION NUMBER (A):

ENGINE SERIAL NUMBER (B):

<https://www.ebooklibonline.com>

Hello dear friend!

Thank you very much for reading.

Enter the link into your browser.

The full manual is available for immediate download.

<https://www.ebooklibonline.com>

TABLE OF CONTENTS

Safety	1
Operating	8
Replacement Parts	21
Service Intervals	22
Service Lubrication	23
Service Engine	24
Service Mower	30
Service Electrical	44
Service Miscellaneous	48
Troubleshooting	50
Storage	53
Assembly	55
Specifications	57
Warranty	59
Index	62

All information, illustrations and specifications in this manual are based on the latest information at the time of publication. The right is reserved to make changes at any time without notice.

COPYRIGHT© 2000
Deere & Co.

John Deere Worldwide Commercial and
Consumer Equipment Division
Horicon, WI

All rights reserved
Previous Editions
COPYRIGHT© 1998, 1997, 1996

OMM143122 E0 - English

SAFETY

Understanding The Machine Safety Labels

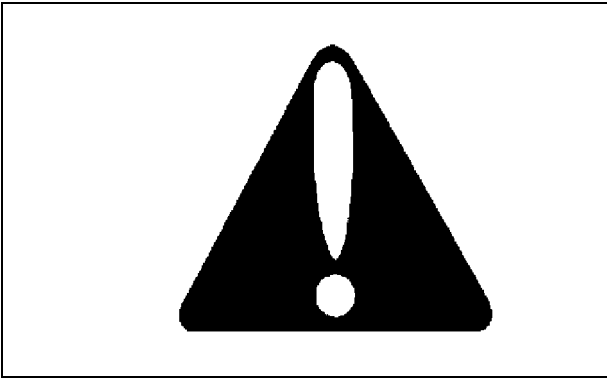

The machine safety labels shown in this section are placed in important areas on your machine to draw attention to potential safety hazards.

On your machine safety labels, the words **DANGER**, **WARNING**, and **CAUTION** are used with this safety-alert symbol, (▲). **DANGER** identifies the most serious hazards.

The operator's manual also explains any potential safety hazards whenever necessary in special safety messages that are identified with the word, **CAUTION**, and the safety-alert symbol, (▲).

WARNING: AVOID SERIOUS INJURY OR DEATH



- Drive up and down slopes, not across.
- Avoid sudden turns.
- If machine stops going uphill, stop blade and back down slowly.
- Keep safety devices (guards, shields, and switches) in place and working.
- Read Operator's Manual.
- When leaving machine: Stop engine, Set park brake,

Remove key.

DANGER: ROTATING BLADES CUT OFF ARMS AND LEGS



- Do not mow when children or others are around.
- Do not mow in reverse.
- Look down and behind before and while backing.
- Never carry children even with the blades off.

DANGER: ROTATING BLADE



- Do not put hands or feet under or into mower when engine is running.

SAFETY

DANGER: ROTATING BLADE-THROWN OBJECTS



Picture Note: Two decals located on mower deck.

- Rotating blades.
- Do not put hands or feet under or into mower when engine is running.
- Thrown objects.
- Before mowing, clear area of objects that may be thrown by blade.
- Do not operate mower without discharge chute or entire grass catcher in place.

DANGER: POISON

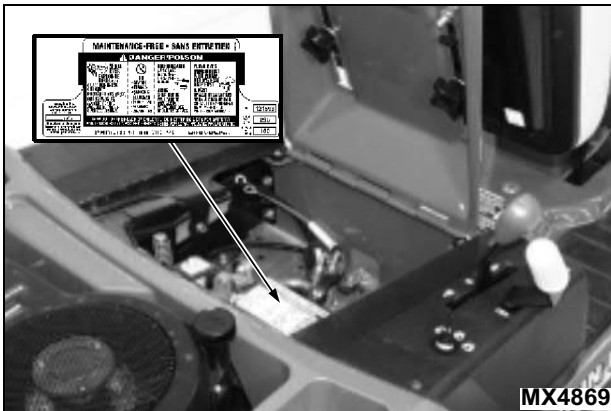

- Shield eyes. Explosive gases can cause blindness or injury.
- No sparks, flames, smoking.
- Sulfuric acid can cause blindness or severe burns.
- Flush eyes immediately with water.
- Get medical help fast.
- Keep out of the reach of children.
- Do not tip.

- Do not open battery!

Emission Control System Certification Label

NOTE: *Tampering with emission controls and components by unauthorized personnel may result in severe fines or penalties. Emission controls and components can only be adjusted by EPA and/or CARB authorized service centers. Contact your John Deere Commercial and Consumer Equipment Retailer concerning emission controls and component questions.*

The presence of an emissions label signifies that the engine has been certified with the United States Environmental Protection Agency (EPA) and/or California Air Resources Board (CARB).

The emissions warranty applies only to those engines marketed by John Deere that have been certified by the EPA and/or CARB; and used in the United States and Canada in off-road mobile equipment.

Emission Compliance Period

If your engine has the emission compliance category listed on the emission control system certification or air index label, this indicates the number of operating hours for which the engine has been certified to meet EPA and/or CARB emission requirements. The following table provides the engine compliance period in hours associated with the category found on the certification label.

Agency	Category	Hours
EPA	C	250
EPA	B	500
EPA	A	1000
CARB	Moderate	125
CARB	Intermediate	250
CARB	Extended	500

Certification

Your mower has been certified by an independent laboratory for compliance with American National Standard B-71.1, "Safety Specifications" for Power Lawn Mowers, Lawn and Garden Tractors, and Lawn Tractors.

SAFETY

Operating Safely

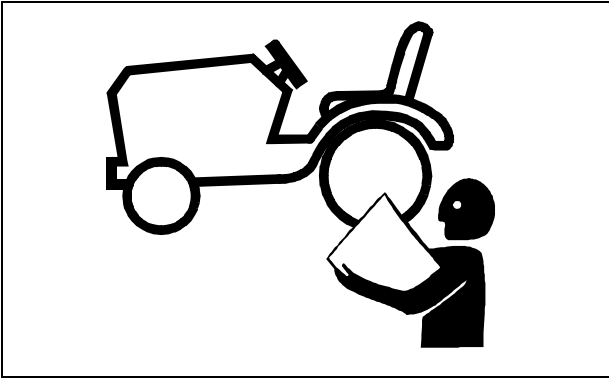

- Read, understand and follow all instructions in the manual and on the machine before starting.
- Only allow responsible adults, who are familiar with the instructions to operate the machine.
- Inspect machine before you operate. Be sure hardware is tight. Repair or replace damaged, badly worn, or missing parts. Be sure guards and shields are in good condition and fastened in place. Make any necessary adjustments before you operate.
- Check brake action before you operate. Adjust or service brakes as necessary.
- Stop machine if anyone enters the area.
- If you hit an object, stop the machine and inspect it. Make repairs before you operate. Keep machine and attachments properly maintained and in good working order.
- Be aware of the mower discharge direction and make sure that no one is in the path of the discharge direction.
- Do not leave machine unattended when it is running.
- Only operate during daylight or with good artificial light.
- Be careful of traffic when operating near or crossing roadways.
- Do not wear radio or music headphones while operating the machine. Safe operation requires your full attention.
- Older adults are involved in a large percentage of riding mower accidents involving injury. These operators should evaluate their ability to operate a mower safely enough to protect the operator and others from serious injury.

Checking Mowing Area

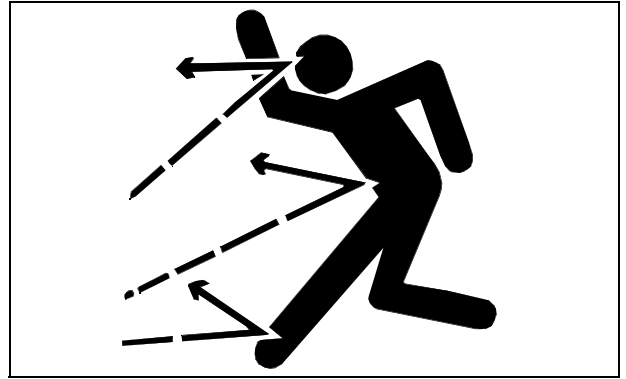

- Clear mowing area of objects that might be thrown. Keep people and pets out of mowing area.
- Study mowing area. Set up a safe mowing pattern. Do not mow where traction or stability is doubtful.
- Test drive area with mower lowered but not running. Slow down when you travel over rough ground.

Parking Safely

1. Stop machine on a level surface, not on a slope.
2. Disengage mower blades.
3. Lower attachments to the ground.
4. Lock the park brake.
5. Stop the engine.
6. Remove the key.
7. Wait for engine and all moving parts to stop before you leave the operator's seat.
8. Close fuel shut-off valve, if your machine is equipped.

SAFETY

Rotating Blades are Dangerous

HELP PREVENT SERIOUS OR FATAL ACCIDENTS:

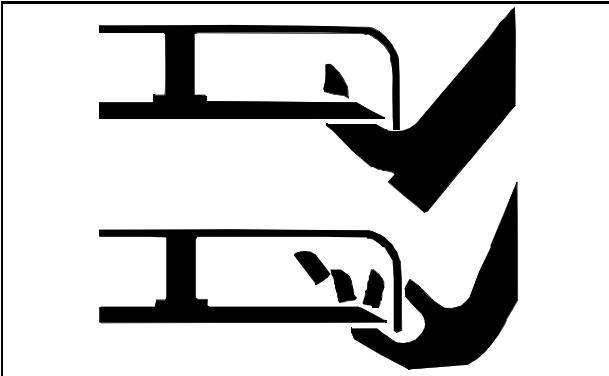

- Rotating blades can cut off arms and legs.
- Keep hands, feet and clothing away from mower deck when engine is running.
- Be alert at all times, drive forward carefully. People, especially children can move quickly into the mowing area before you know it.
- Before backing up, shut off PTO and look down and behind the machine carefully, especially for children.
- Do not mow in reverse.
- Shut off blades when you are not mowing.
- Do not operate machine if you are under the influence of drugs or alcohol.
- Park machine safely before inspecting or unplugging mower or bagger.

PROTECT CHILDREN:

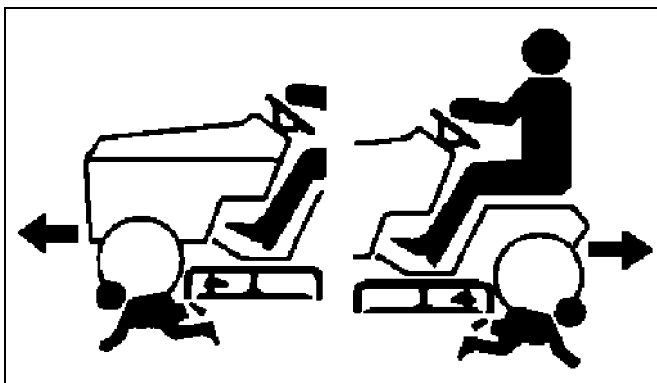

- Never assume that children will remain where you last saw them. Children are attracted to mowing activity, stay alert to the presence of children.
- Keep children indoors when you are mowing. Turn the machine off if a child enters the mowing area.
- Use extra care when you come to blind corners, shrubs,

trees, or other objects that may block your vision.

- Do not let children or an untrained person operate the machine.
- Do not carry or let children ride on any attachment or machine even with the blades off. Do not tow children in a cart or trailer.

Avoid Tipping

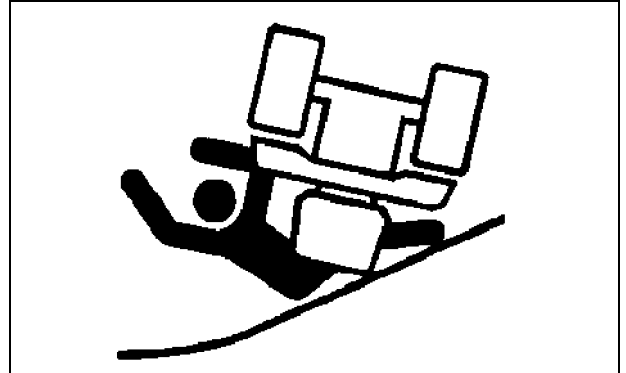

- Slopes are a major factor related to loss-of-control and tip-over accidents, which can result in severe injury or death. If you cannot back up the slope or if you feel uneasy on it, do not mow it.
- Do not drive where machine could slip or tip.
- Stay alert for holes and other hidden hazards in the terrain.
- Keep away from drop-offs, ditches and embankments.
- Slow down before you make a sharp turn or operate on a slope. Choose a low gear so that you will not have to stop or shift while on the slope.
- Limit loads to those you can safely control. Use only approved hitches when pulling loads or using heavy equipment. Use counterweights or wheel weights as required in this manual or your attachment manual.
- Use wheel weights for added stability when operating on slopes or using rear mounted attachments.
- Drive up and down a hill - not across. Turn slowly and turn downhill. Do not shift to neutral and coast downhill.
- Do not stop when going up hill or down hill. If machine stops going up hill, disengage mower blades and back down slowly.
- Mowing when grass is wet can cause reduced traction and sliding.
- Do not try to stabilize the machine by putting your foot on the ground.

SAFETY

Keep Riders Off

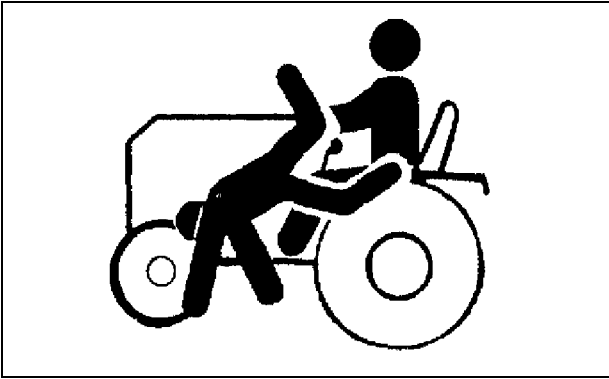

- Only allow the operator on the machine. Keep riders off.
- Riders on the machine or attachment may be struck by foreign objects or thrown off the machine causing serious injury.
- Riders obstruct the operator's view resulting in the machine being operated in an unsafe manner.

Wear Appropriate Clothing

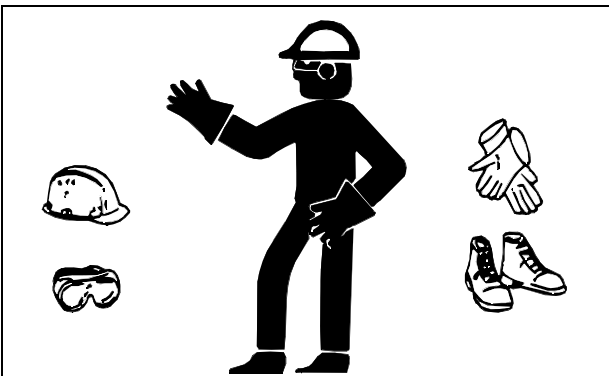

- Wear close fitting clothing and safety equipment appropriate for the job.
- Always wear safety goggles or safety glasses with side shields when operating the mower.
- Wear a suitable protective device such as earplugs. Loud noise can cause impairment or loss of hearing.
- Do not wear radio or music headphones. Safe service and operation requires your full attention.

Driving Safely on Public Roads

Avoid personal injury or death resulting from a collision with another vehicle on public roads:

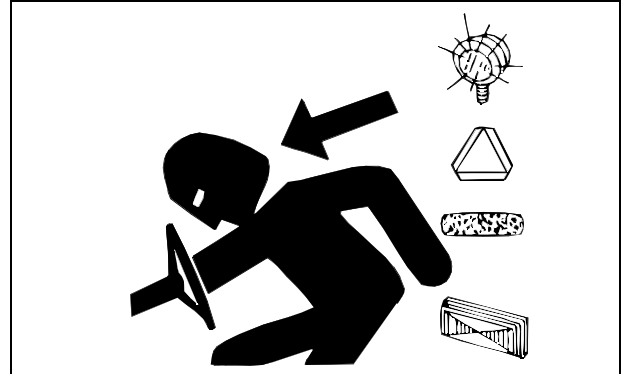

- Use safety lights and devices. Slow moving machines when driven on public roads are hard to see, especially at night.
- Use extra care when loading or unloading the machine into a trailer or truck.
- Whenever driving on public roads, use flashing warning lights and turn signals according to local regulations. Extra flashing warning lights may need to be installed.

Practice Safe Maintenance



- Understand service procedure before doing work. Keep area clean and dry.
- Never lubricate, service, or adjust machine while it is moving. Keep safety devices in place and in working condition. Keep hardware tight.
- Keep hands, feet, clothing, jewelry, and long hair away from any moving parts, to prevent them from getting caught.
- Lower attachments to the ground before servicing machine. Disengage all power and stop the engine. Lock

SAFETY

park brake and remove the key. Let machine cool.

- Disconnect battery or remove spark plug wire before making any repairs.
- Before servicing the machine, carefully release pressure from any components with stored energy, such as hydraulic components.
- Keep all nuts and bolts tightened, especially blade attachment bolts.
- Securely support any machine elements that must be raised for service work.
- Never run engine unless park brake is locked.
- Keep all parts in good condition and properly installed. Fix damage immediately. Replace worn or broken parts. Replace all worn or damaged safety and instruction decals.
- To prevent fires, remove any buildup of grease, oil, or debris from the machine, especially the engine compartment.
- Charge batteries in an open, well-ventilated area, away from sparks. Unplug battery charger before connecting or disconnecting from the battery. Use insulated tools.
- Do not modify machine or safety devices. Unauthorized modifications may impair its function and safety.
- Do not wear radio or music headphones while servicing the machine. Safe service requires your full attention.

Prevent Fires

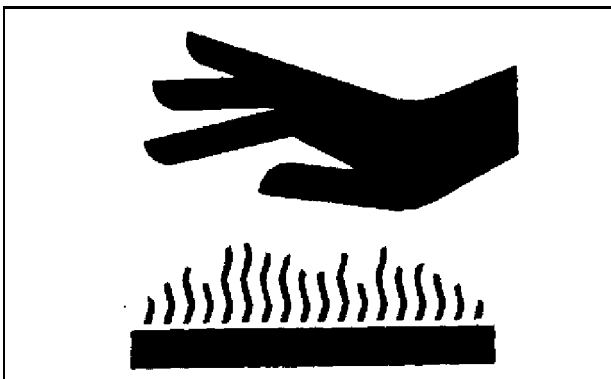

- Never remove fuel cap, or add fuel with engine running or hot. Allow engine to cool for several minutes.
- Never store equipment with fuel in the tank inside a building where fumes may reach an open flame or spark.
- Allow engine to cool before storing in any enclosure.
- To reduce fire hazard, keep engine free of grass, leaves, or excessive grease.

Tire Safety

Explosive separation of a tire and rim parts can cause serious injury or death:

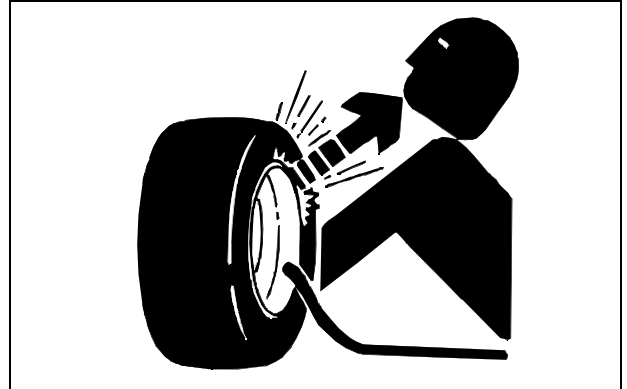

- Do not attempt to mount a tire without the proper equipment and experience to perform the job.
- Always maintain the correct tire pressure. Do not inflate the tires above the recommended pressure. Never weld or heat a wheel and tire assembly. The heat can cause an increase in air pressure resulting in a tire explosion. Welding can structurally weaken or deform the wheel.
- When inflating tires, use a clip-on chuck and extension hose long enough to allow you to stand to one side and NOT in front of or over the tire assembly.
- Check tires for low pressure, cuts, bubbles, damaged rims or missing lug bolts and nuts.

Handling Fuel Safely

Fuel and fuel vapors are highly flammable:

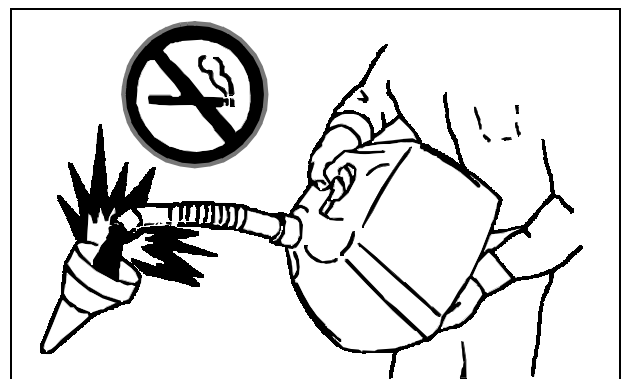

- Do not refuel machine while you smoke, when machine is near an open flame or sparks, or when engine is running. stop engine and allow to cool before filling.
- Never remove the gas cap or add fuel with the engine

SAFETY

running.

- Never fill fuel tank or drain fuel from a machine in an enclosed area. Fill fuel tank outdoors.
- Prevent fires. Clean up spilled fuel immediately.
- Do not store machine with fuel in tank in a building where fumes may reach an open flame or spark.
- Prevent fire and explosion caused by static electric discharge. Use only non-metal, portable fuel containers approved by the Underwriter's Laboratory (U.L.) or the American Society for Testing & Materials (ASTM). If using a funnel, make sure it is plastic and has no screen or filter.
- Static electric discharge can ignite gasoline vapors in an ungrounded fuel container. Remove the fuel container from the bed of a vehicle or the trunk of a car and place on the ground away from the vehicle before filling. Keep nozzle in contact with container opening while filling.



- When practical, remove equipment from trailers or truck beds and refuel them on the ground. If this is not possible, use a portable, plastic fuel container to refuel equipment on a truck bed or trailer.
- Do not use methanol gasoline. Methanol is harmful to the environment and to your health.

Handling Waste Product and Chemicals

Waste products, such as, used oil, fuel, coolant, brake fluid, and batteries, can harm the environment and people:

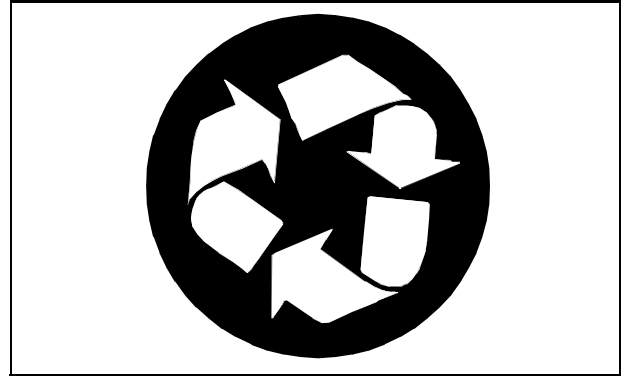

- **DO NOT** use beverage containers for waste fluids - someone may drink from them.
- See your local Recycling Center or John Deere dealer to learn how to recycle or get rid of waste products.
- A Material Safety Data Sheet (MSDS) provides specific details on chemical products: physical and health hazards, safety procedures, and emergency response techniques. The seller of the chemical products used with your machine is responsible for providing the MSDS for that product.

OPERATING

Daily Operating Checklist

- Test safety systems.
- Check tire pressure.
- Check fuel level.
- Check engine oil level.
- Remove grass and debris from machine.
- Clean air intake screen.
- Check area below machine for leaks.

Avoid Damage to Plastic and Painted Surfaces

- Do not wipe plastic parts unless rinsed first.
- Insect repellent spray may damage plastic and painted surfaces. Do not spray insect repellent near machine.
- Be careful not to spill fuel on machine. Fuel may damage surface. Wipe up spilled fuel immediately.

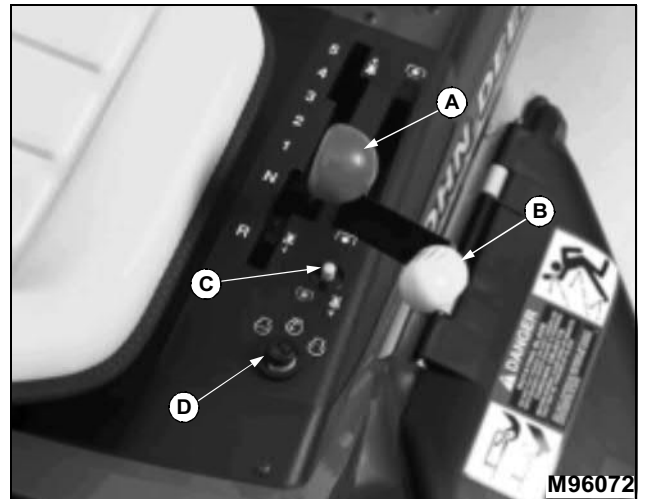

Picture Note: GX85 Shown

- A - Shift Lever
- B - Mower Engagement (PTO) Lever
- C - Reverse Implement Option (RIO) Button
- D - Key

Operator Station Controls

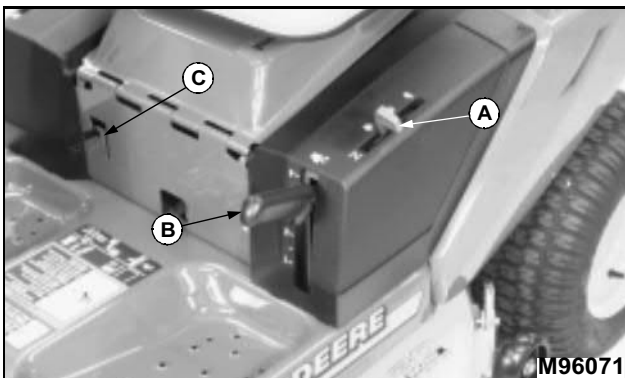

- A - Throttle / Choke Lever
- B - Mower Lift Lever
- C - Park Brake Lever

Foot Controls

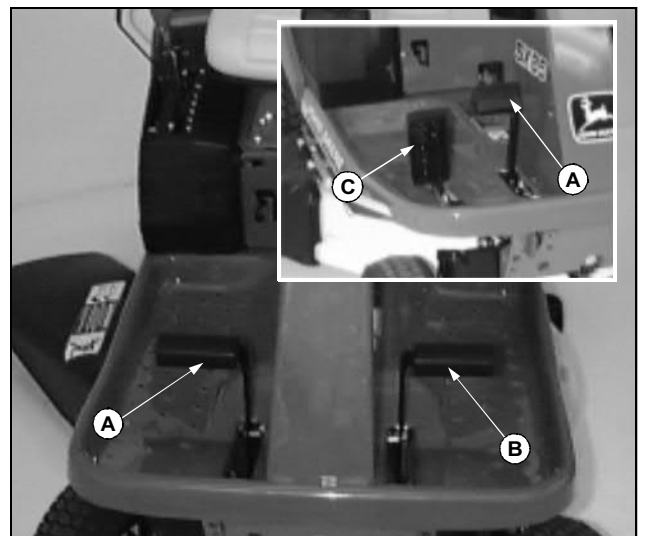

- A - Brake Pedal
- B - Clutch (GX85)
- C - Accelerator (SX85)

OPERATING

Miscellaneous Controls

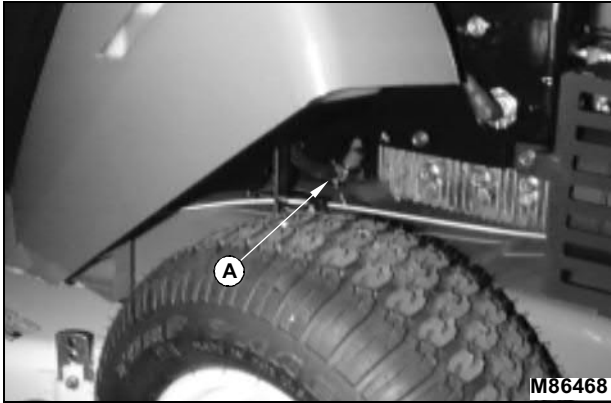

A - Fuel Shut-Off

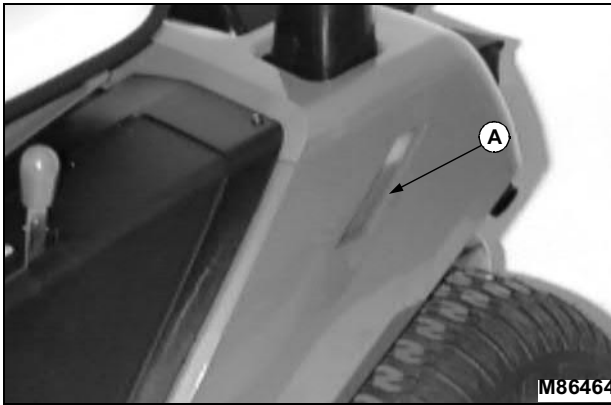

A - Fuel Gauge

Adjusting Seat

1. Lift seat.

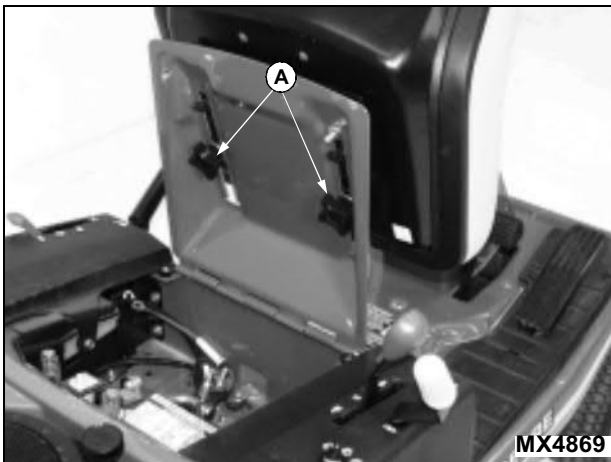

2. Loosen knobs (A).

3. Slide seat forward or rearward to desired position.
4. Tighten knobs.
5. Lower seat.

Adjusting Cutting Height

NOTE: Lift lever should be set at 100 mm (4 in) when transporting machine.

Cutting height can be adjusted from approximately 25–100 mm (1–4 in).

Mower Setting	Approximate Cutting Height
1	25 mm (1 in)
—	38 mm (1-1/2 in)
2	50 mm (2 in)
—	65 mm (2-1/2 in)
3	75 mm (3 in)
—	90 mm (3-1/2 in)
4 (Transport)	100 mm (4 in)



1. Put cutting height lift lever (A) into the slot adjacent to desired cutting height.
2. Adjust mower deck wheels.

OPERATING

Adjusting Mower Deck Wheels



CAUTION: Avoid injury! Rotating blades are dangerous. Before adjusting or servicing mower:

- Disconnect spark plug wire(s) to prevent engine from starting accidentally.
- Always wear gloves when handling mower blades or working near blades.

IMPORTANT: Avoid damage! The mower deck can be damaged if mower wheels are adjusted wrong:

- Wheels must not ride on ground supporting mower weight.
- Check wheel adjustment each time cutting height is changed.

1. Park machine safely. (See Parking Safely in the Safety Section.)
2. Inflate tires to the correct pressure.
3. Raise lift lever to transport position and adjust cutting height.
4. Move mower lift lever to mowing position.

NOTE: Bottom of wheels should be approximately 6-13 mm (1/4-1/2 in.) from the ground.

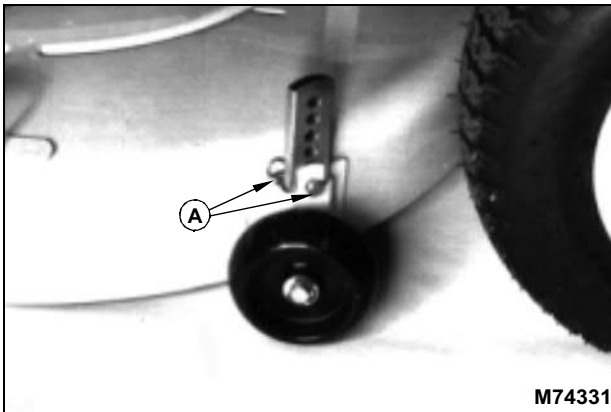

5. Check mower wheel position. Remove spring locking pin and drilled pin (A) and move mower wheels to proper hole.
6. Install spring locking pins and drilled pins to lock wheels in position.

Adjusting Mower Level (Side-to-Side)



CAUTION: Avoid injury! Rotating blades are dangerous. Before adjusting or servicing mower:

- Disconnect spark plug wire(s) to prevent engine from starting accidentally.
- Always wear gloves when handling mower blades or working near blades.

NOTE: Mower wheels should not contact the ground when leveling the deck.

1. Park machine safely. (See Parking Safely in the Safety Section).
2. Inflate tires to the correct pressure.
3. Adjust cutting height to 65 mm (2 1/2 in).
4. Put lift lever in mowing position.

NOTE: The difference between blade measurements must not be more than 3 mm (1/8 in).

5. Turn blade parallel to axle and complete measurement.

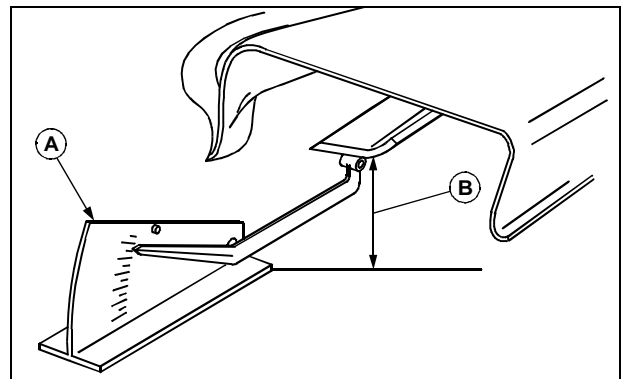

Picture Note: A convenient leveling gauge (A) is available from your John Deere dealer.

6. Measure from each outside blade tip (B) to the level surface.



Suggest:

If the above button click is invalid.

Please download this document

first, and then click the above link

to download the complete manual.

Thank you so much for reading

OPERATING

NOTE: Nut (E) **MUST** remain tight while making adjustment.

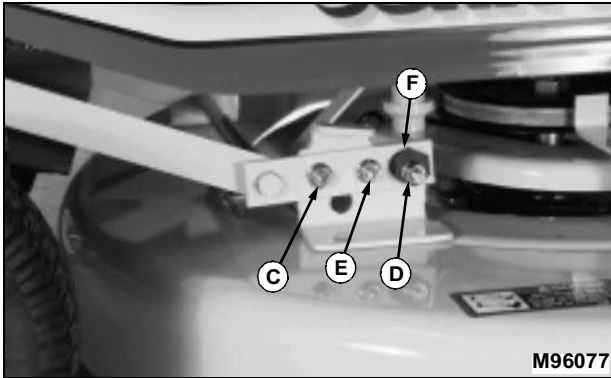

7. Loosen nuts (C) and (D). Do not loosen nut (E).
8. Turn leveling cam (F) to raise or lower left side of mower.
9. Measure blade tips again and adjust if necessary.
10. Tighten nut (C) first and then nut (D).

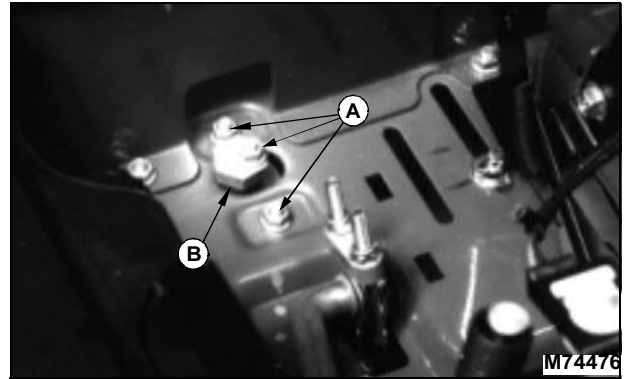

6. Loosen three nuts (A).
7. Turn leveling cam (B) to raise or lower rear of mower as needed.
8. Tighten nuts (A).
9. Measure blade tips again and adjust if necessary.
10. Lower seat.

Adjusting Mower Level (Front-to-Rear)



CAUTION: Avoid injury! Rotating blades are dangerous. Before adjusting or servicing mower:

- Disconnect spark plug wire(s) to prevent engine from starting accidentally.
- Always wear gloves when handling mower blades or working near blades.

NOTE: Mower wheels should not contact the ground during leveling.

1. Park machine safely on a level surface. (See Parking Safety in the Safety Section.)
2. Inflate tires to the correct pressure.
3. Turn blade so blade tip points straight forward.
4. Measure from the front of blade tip to the level surface. The difference between front and rear measurements must not be more than 6 mm (1/4 in).
5. Lift seat.

Testing Safety Systems

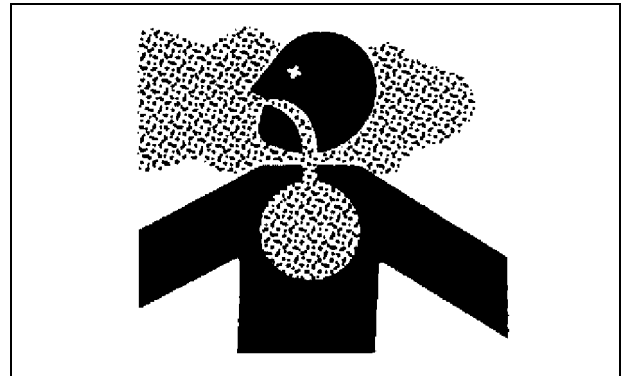

CAUTION: Avoid injury! Engine exhaust fumes contain carbon monoxide and can cause serious illness or death.

Move the vehicle to an outside area before running the engine.

Do not run an engine in an enclosed area without adequate ventilation.

- Connect a pipe extension to the engine exhaust pipe to direct the exhaust fumes out of the area.
- Allow fresh outside air into the work area to clear the exhaust fumes out.

Use the following checkout procedure to check for normal operation of machine.

<https://www.ebooklibonline.com>

Hello dear friend!

Thank you very much for reading.

Enter the link into your browser.

The full manual is available for immediate download.

<https://www.ebooklibonline.com>