

# 8440 & 8640 TRACTORS (REPAIRS)



JOHN DEERE

## TECHNICAL MANUAL 8440 & 8640 TRACTORS (REPAIRS)

TM1199 (01NOV86) English

**John Deere Tractor Works**  
**TM1199 (01NOV86)**

LITHO IN U.S.A.  
ENGLISH



# 8440 AND 8640 TRACTORS TECHNICAL MANUAL TM-1199 (NOV-78)

## CONTENTS—REPAIR SECTIONS

### SECTION 10—GENERAL

- Group 00—Specifications and Special Tools
- Group 05—Predelivery, Delivery, and After-Sale Services
- Group 10—Tune-Up
- Group 15—Lubrication
- Group 20—Separation

### SECTION 20—8440 ENGINE REPAIR

- Group 00—Specifications and Special Tools
- Group 05—Cylinder Head, Valves, and Camshaft
- Group 10—Cylinder Block, Liners, Pistons, and Rods
- Group 15—Crankshaft, Main Bearings, and Flywheel
- Group 20—Lubricating System
- Group 25—Cooling System

### SECTION 25 - 8640 ENGINE REPAIR

- Group 00—Specifications and Special Tools
- Group 05—Cylinder Head, Valves, and Camshaft
- Group 10—Cylinder Block, Liners, Pistons, and Rods
- Group 15—Crankshaft, Main Bearings, and Flywheel
- Group 20—Lubricating System
- Group 25—Cooling System

### SECTION 30—FUEL AND AIR REPAIR

- Group 00—Specifications and Special Tools
- Group 05—Air Intake System
- Group 10—Diesel Fuel System
- Group 15—Control Linkage

### SECTION 40—ELECTRICAL REPAIR

- Group 00—Specifications and Special Tools
- Group 05—Harness Replacement
- Group 10—Charging Circuit
- Group 15—John Deere Starting Circuit
- Group 20—Delco-Remy Starting Circuit
- Group 25—Lighting Circuits
- Group 30—Instrument Circuits
- Group 35—Accessory Circuits

### SECTION 50—POWER TRAIN REPAIR

- Group 00—Specifications and Special Tools
- Group 05—PERMA-CLUTCH™
- Group 10—QUAD-RANGE™ Planetary
- Group 15—Independent PTO
- Group 20—Torque Divider and Drive Shafts
- Group 25—QUAD-RANGE Transmission
- Group 30—Differentials
- Group 35—Final Drives

### SECTION 60—STEERING/BRAKES REPAIR

- Group 00—Specifications and Special Tools
- Group 05—Power Steering
- Group 10—Power Brakes

### SECTION 70—HYDRAULIC REPAIR

- Group 00—Specifications and Special Tools
- Group 05—Miscellaneous Hydraulic Components
- Group 10—Hydraulic Pumps
- Group 15—Rockshaft and Implement Hitches
- Group 20—Selective Control Valve, Breakaway Coupler, and Remote Cylinder

### SECTION 80—MISCELLANEOUS

- Group 00—Specifications and Special Tools
- Group 05—Wheels

### SECTION 90—OPERATOR STATION REPAIR

- Group 00—Specifications and Special Tools
- Group 05—Air Conditioning System
- Group 10—Heating System
- Group 15—Seat
- Group 20—Miscellaneous Components

(Continued on page 2)

*All information, illustrations and specifications contained in this technical manual are based on the latest information available at the time of publication. The right is reserved to make changes at any time without notice.*

**Copyright© 1978  
DEERE & COMPANY  
Moline, Illinois  
All rights reserved**

## CONTENTS—OPERATION AND TESTS SECTIONS

### SECTION 220—8440 ENGINE OPERATION AND TESTS

- Group 00—Specifications and Special Tools
- Group 05—System Operation
- Group 10—System Tests and Diagnosis

### SECTION 225—8640 ENGINE OPERATION AND TESTS

- Group 00—Specifications and Special Tools
- Group 05—System Operation
- Group 10—System Tests and Diagnosis

### SECTION 230—FUEL/AIR OPERATION AND TESTS

- Group 00—Specifications and Special Tools
- Group 05—Air Intake System
- Group 10—Diesel Fuel System
- Group 15—Control Linkage

### SECTION 240—ELECTRICAL OPERATION AND TESTS

- Group 00—Specifications and Special Tools
- Group 05—General Information and Diagrams
- Group 10—Electrical System Diagnosis
- Group 15—Charging Circuit
- Group 20—John Deere Starting Circuits
- Group 25—Delco-Remy Starting Circuits
- Group 30—Lighting Circuits
- Group 35—Instrument Circuits
- Group 40—Accessory Circuits
- Group 45—Electrical Remote Control and Outlet Socket

### SECTION 250—POWER TRAIN OPERATION AND TESTS

- Group 00—Specifications and Special Tools
- Group 05—Quad-Range System Operation
- Group 10—Independent PTO Operation
- Group 15—Torque Divider, Drive Shafts, Differentials and Final Drive Operation
- Group 20—Power Train Tests and Diagnosis

### SECTION 260—STEERING/BRAKES OPERATION AND TESTS

- Group 05—Power Steering
- Group 10—Power Brakes

### SECTION 270—HYDRAULIC OPERATION AND TESTS

- Group 00—Specifications and Special Tools
- Group 05—Hydraulic System Operation
- Group 10—Hydraulic System Tests
- Group 15—Miscellaneous Hydraulic Components
- Group 20—Hydraulic Pumps
- Group 25—Rockshaft and Implement Hitches
- Group 30—Selective Control Valve, Breakaway Coupler, and Remote Cylinder

### SECTION 290—OPERATOR STATION OPERATION AND TESTS

- Group 00—Specifications and Special Tools
- Group 05—Air Conditioning System Operation
- Group 10—Air Conditioning System Tests and Diagnosis
- Group 15—Heating System

**<https://www.ebooklibonline.com>**

Hello dear friend!

Thank you very much for reading.

Enter the link into your browser.

The full manual is available for immediate download.

**<https://www.ebooklibonline.com>**

# Section 10 GENERAL

## CONTENTS OF THIS SECTION

	Page		Page
<b>GROUP 00—SPECIFICATIONS</b>		<b>GROUP 15—LUBRICATION</b>	
General Tractor Specifications .....	00-1	Lubricants .....	15-1
Predelivery .....	00-4	Engine .....	15-2
Tune-Up .....	00-5	Transmission-Hydraulic System .....	15-3
Lubrication .....	00-5	Grease Fittings .....	15-5
Separation .....	00-6		
Special Tools .....	00-7	<b>GROUP 20—SEPARATION</b>	
<b>GROUP 05—PREDELIVERY, DELIVERY,   AND AFTER-SALE SERVICES</b>		Front Drive Removal Without Support .....	20-2
Predelivery Services .....	05-1	Front Drive Removal With Support .....	20-4
Delivery Services .....	05-9	Fuel Tank Removal .....	20-7
After-Sale Services .....	05-10	Front End Removal Without Engine .....	20-8
<b>GROUP 10—TUNE-UP</b>		Front End Removal With Engine .....	20-13
Preliminary Engine Testing .....	10-1	Front End Removal from Clutch Housing ...	20-18
Tune-Up Procedures .....	10-1	Clutch Housing Removal .....	20-22
Operation .....	10-7	Sound-Gard Body Removal .....	20-30
		Hinge Separation .....	20-35
		Front Hinge Removal .....	20-39
		Rear Hinge Removal .....	20-42
		Torque Divider-to-Rear Hinge Separation ...	20-44
		Transmission Separation .....	20-49
		Front Final Drive Removal .....	20-51
		Rear Final Drive Removal .....	20-53

## Group 00 SPECIFICATIONS AND SPECIAL TOOLS GENERAL TRACTOR SPECIFICATIONS

	8440	8640
<b>HORSEPOWER (Factory observed PTO horsepower at 2100 rpm)</b>	175 hp (130 kW)	225 hp (168 kW)
<b>ENGINE:</b>		
Type	6-cylinder, in-line, valve-in-head, diesel, turbocharged, intercooled	6-cylinder, in-line, valve-in-head, diesel, turbocharged, intercooled
Slow idle speed	780 to 820 rpm	780 to 820 rpm
Working speed range	1500 to 2100 rpm	1500 to 2100 rpm
Bore and stroke	4.56 x 4.75 in. (116 x 121 mm)	5.12 x 5.00 in. (130 x 127 mm)
Displacement	466 cu. in. (7640 cm <sup>3</sup> )	619 cu. in. (10 143 cm <sup>3</sup> )
Compression ratio	15.5 to 1	14.7 to 1
Firing order	1-5-3-6-2-4	1-5-3-6-2-4
Valve clearance		
Intake	0.018 in. (0.46 mm)	0.015 in. (0.38 mm)
Exhaust	0.028 in. (0.71 mm)	0.025 in. (0.64 mm)
Injection pump timing	TDC	TDC
Lubrication system	force-feed, pressurized with full-flow filter	force-feed, pressurized with full-flow filter

	8440	8640
<b>FUEL SYSTEM:</b>		
Type	direct injection	direct injection
Injection pump type	in-line	in-line
Air cleaner	dry type with safety element	dry type with safety element
<b>COOLING SYSTEM:</b>		
Type	dual-pressure with centrifugal pump	dual-pressure with centrifugal pump
Temperature control	two heavy duty thermostats	three heavy duty thermostats
<b>CAPACITIES:</b>		
Fuel tank	156 U.S. gallons (590 L)	200 U.S. gallons (757 L)
Cooling system	40 U.S. quarts (42 L)	48 U.S. quarts (51 L)
Crankcase (with filter change)	20 U.S. quarts (19 L)	24 U.S. quarts (23 L)
Transmission-hydraulic system (wet system)	35 U.S. gallons (132 L)	36 U.S. gallons (136 L)
<b>QUAD-RANGE TRANSMISSION:</b>		
Type	2-speed, power-shifted planetary and 8-speed synchronized. 16 forward and 6 reverse	
Gear selections	hydraulically-operated, multiple-disk wet clutch	
Perma-Clutch		
<b>POWER TAKE-OFF:</b>		
Type	fully independent	fully independent
Speed (2100 engine rpm)	1000 rpm	1000 rpm
Size	1-3/4 in. (45 mm)	1-3/4 in. (45 mm)
Clutch	hydraulically-operated, multiple-disk wet clutch	hydraulically-operated, multiple-disk wet clutch
<b>HYDRAULIC SYSTEM:</b>		
Type	closed-center, constant-pressure	closed-center, constant-pressure
Standby pressure	2250 psi (155 bar) (155 kg/cm <sup>2</sup> )	2250 psi (155 bar) (155 kg/cm <sup>2</sup> )
<b>BRAKES:</b>		
Type	hydraulically-operated wet disk	hydraulically-operated wet disk
<b>ELECTRICAL SYSTEM:</b>		
Type	12-volt, negative ground	12-volt, negative ground
Batteries	two, 6-volt, 5D group, 800 amps cold cranking, 376 minutes reserve capacity	two, 6-volt, 4 group, 975 amps cold cranking, 420 minutes reserve capacity
Alternator	90-amp	90-amp
<b>TIRES AND TREADS:</b>		
	see page 05-3 in this section	see page 05-3 in this section

8440

8640

DIMENSIONS:

Wheel base.....	125 in. (3175 mm).....	125 in. (3175 mm)
Over-all length.....	224.2 in. (5696 mm).....	224.2 in. (5696 mm)
Over-all height to top of muffler.....	134.5 in. (3416 mm).....	134.5 in. (3416 mm)
Over-all width-reg. axle.....	95.8 in. (2434 mm).....	96.0 in. (2440 mm)
-long axle.....	118.4 in. (3008 mm).....	118.7 in. (3014 mm)
Turning radius (80-in. [2.03 m] tread).....	223 in. (567 mm).....	223 in. (567 mm)
SHIPPING WEIGHT**.....	21225 lbs (9628 kg).....	22838 lbs (10359 kg)

\*\*Equipped for average field service, without fuel and ballast.

QUAD-RANGE TRANSMISSION GROUND SPEEDS

Approximate ground speeds are given in the following charts. Speeds are shown in miles per hour, with kilometers per hour in parentheses.

Speeds are for a Tractor with 18.4-38 tires.

8440 TRACTOR				8640 TRACTOR			
Range	Speed	2100 Engine RPM	1500 Engine RPM	Range	Speed	2100 Engine RPM	1500 Engine RPM
A	1	2.20 (3.54)	1.6 (2.5)	A	1	2.10 (3.38)	1.5 (2.4)
	2	2.74 (4.41)	2.0 (3.1)		2	2.62 (4.21)	1.9 (3.0)
	3	3.97 (6.39)	2.8 (4.6)		3	3.79 (6.09)	2.7 (4.3)
	4	4.96 (7.98)	3.5 (5.7)		4	4.73 (7.60)	3.4 (5.4)
	1R	4.30 (6.92)	3.1 (4.9)		1R	4.10 (6.59)	2.9 (4.7)
	2R	5.36 (8.63)	3.8 (6.1)		2R	5.11 (8.21)	3.6 (5.9)
B	1	4.85 (7.80)	3.5 (5.6)	B	1	4.63 (7.44)	3.3 (5.3)
	2	6.06 (9.75)	4.3 (7.0)		2	5.77 (9.28)	4.1 (6.6)
	3	8.77 (14.11)	6.2 (10.1)		3	8.36 (13.44)	6.0 (9.6)
	4	10.94 (17.61)	7.8 (12.6)		4	10.43 (16.77)	7.4 (12.0)
	1R	9.49 (15.27)	6.8 (10.9)		1R	9.05 (14.55)	6.5 (10.4)
	2R	11.84 (19.05)	8.5 (13.6)		2R	11.29 (18.15)	8.1 (13.0)
C	1	5.80 (9.33)	4.1 (6.7)	C	1	5.53 (8.89)	3.9 (6.3)
	2	7.24 (11.65)	5.2 (8.3)		2	6.90 (11.09)	4.9 (7.9)
	3	10.49 (16.88)	7.5 (12.1)		3	10.00 (16.08)	7.1 (11.5)
	4	13.08 (21.05)	9.3 (15.0)		4	12.47 (20.05)	8.9 (14.3)
	1R	11.35 (18.27)	8.1 (13.0)		1R	10.82 (17.40)	7.7 (12.4)
	2R	14.16 (22.79)	10.1 (16.3)		2R	13.50 (21.71)	9.6 (15.5)
D	1	9.40 (15.13)	6.7 (10.8)	D	1	8.96 (14.40)	6.4 (10.3)
	2	11.73 (18.88)	8.4 (13.5)		2	11.19 (17.99)	8.0 (12.8)
	3	17.00 (27.36)	12.1 (19.5)		3	16.20 (26.05)	11.6 (18.6)
	4	21.20 (34.12)	15.1 (24.4)		4	20.22 (32.51)	14.4 (23.2)

(Specifications and design subject to change without notice.)

## PREDELIVERY, DELIVERY, AND AFTER-SALE SERVICES

Item	Specification
Injection pump timing .....	TDC
Engine speeds	
Slow idle .....	780 to 820 rpm
Fast idle .....	2225 to 2325 rpm
Rated speed at full load .....	2100 rpm

Torque	ft-lbs	Nm	kgm
Sound-Gard Body mounting bolts .....	150	200	20
Special bolts on hubs .....	300	410	41
Steel wheel-to-hub bolts .....	240	325	33
Rimclamp-to-wheel bolts .....	170	230	23
Rockshaft lift arm retaining bolts .....	300	410	41
Other nuts and cap screws:			

### TORQUE CHART

Bolt Diameter	Plain Head*			Three Radial Dashes*			Six Radial Dashes*		
	ft-lbs	Nm	kgm	ft-lbs	Nm	kgm	ft-lbs	Nm	kgm
1/4 in.	6	8	0.8	10	14	1.4	14	19	1.9
5/16 in.	13	18	1.8	20	27	2.7	30	41	4.1
3/8 in.	23	31	3.1	35	47	4.7	50	70	7.0
7/16 in.	35	47	4.7	55	75	7.5	80	110	11
1/2 in.	55	75	7.5	85	115	12	120	160	16
9/16 in.	75	100	10	130	175	18	175	240	24
5/8 in.	105	140	14	170	230	23	240	325	33
3/4 in.	185	250	25	300	410	41	425	575	58
7/8 in.	160	220	22**	445	600	60	685	930	93
1 in.	250	340	34**	670	900	90	1030	1400	140

\*The types of bolts and cap screws are identified by head markings as follows:

Plain Head: regular machine bolts and cap screws.

3-Dash Head: tempered steel high-strength bolts and cap screws.

6-Dash Head: tempered steel high-strength bolts and cap screws.

\*\*Machine bolts and cap screws 7/8-inch and larger are sometimes formed hot rather than cold, which accounts for the lower torque.

## TUNE-UP

Item	Specification
PTO horsepower	175 hp (130 kW)
8440 .....	
8460 .....	225 hp (168 kW)
Compression .....	330—370 psi (22.5—25.5 bar)
Vacuum (full speed, full load, clean air filters) .....	10.5—11.5 in. (26—29 mbar)
Air cleaner indicator switch closing vacuum .....	24—26 in. (60—65 mbar)
Manifold pressure (full speed, full load, clean air filter)	
8440 .....	18—23 psi (1.2—1.6 bar)
8640 .....	20—24 psi (1.4—1.7 bar)
Thermostat opening temperature .....	180°F (82°C)
Radiator cap pressure release .....	14—17 psi (0.9—1.2 bar)
Engine speeds	
Slow idle .....	780—820 rpm
Fast idle .....	2225—2325 rpm
Rated speed at full load .....	2100 rpm

## LUBRICATION

Engine Crankcase Oil Capacity	
8440 .....	20 U.S. quarts (19 L)
8640 .....	24 U.S. quarts (23 L)
Transmission-hydraulic system oil capacity (drain and fill)	
8440 .....	35 U.S. gallons (132 L)
8640 .....	36 U.S. gallons (136 L)
Service intervals	
Check engine oil level .....	Every 10 hours
Change engine oil .....	Every 100 hours
Replace engine oil filter .....	Every 200 hours
Replace engine coolant filter .....	Every 200 hours
Check transmission-hydraulic system oil level .....	Every 10 hours
Replace clutch oil filter .....	Under either of the following conditions:
	a. When the instrument Audible Warning System filter restriction on indicator light comes on.
	b. When the transmission oil is changed.
Replace transmission-hydraulic system oil filter .....	Under any of the following conditions:
	a. Every 600 hours
	b. When sluggish hydraulics occur.
	c. When the transmission oil is changed.
Change transmission-hydraulic oil .....	Every 1200 hours
Clean main hydraulic pump screen .....	Every 1200 hours
Lubricate grease fittings	
Hinge pivot pins .....	Every 10 hours
Steering cylinder pivot pins .....	Every 10 hours
Wide-swing drawbar .....	Every 10 hours
Universal joints and slip joints .....	Every 10 hours
3-point hitch .....	Every 200 hours
Front and rear axle bearings .....	Every 600 hours
Front differential oscillating pivot pins .....	Every 600 hours or Annual

## SEPARATION

Item	Specification
Fan belt tension	New Belt
Single belt .....	130-140 lbs. (578-622 N)
Dual belt .....	95-104 lbs. (423-467 N)
All Belts .....	After Run In 85-94 lbs. (378-423 N)
Final Drives	
Front axle housing-to-differential case .....	240 ft-lbs (325 Nm) (33 kgm)
Rear axle housing-to-transmission case .....	170 ft-lbs (230 Nm) (23 kgm)
Front	
Side frame-to-differential support .....	300 ft-lbs (407 Nm) (41 kgm)
Differential support-to-engine mount (front) .....	300 ft-lbs (407 Nm) (41 kgm)
Engine mount-to-differential support .....	170 ft-lbs (230 Nm) (23 kgm)
Front differential mount	
8440 .....	450 ft-lbs (610 Nm) (61 kgm)
8640 .....	670 ft-lbs (908 Nm) (91 kgm)
Rear differential mount	
8440 .....	445 ft-lbs (603 Nm) (60 kgm)
8640 .....	300 ft-lbs (407 Nm) (41 kgm)
Engine	
Engine-to-clutch housing .....	300 ft-lbs (407 Nm) (41 kgm)
Oil pan-to-clutch housing	
8440 .....	85 ft-lbs (115 Nm) (12 kgm)
8640 .....	300 ft-lbs (407 Nm) (41 kgm)
Mount-to-cylinder block	
8440 .....	170 ft-lbs (230 Nm) (23 kgm)
8640 .....	300 ft-lbs (407 Nm) (41 kgm)
Hinge Area	
Front hinge-to-clutch housing .....	300 ft-lbs (407 Nm) (41 kgm)
Sound-Gard Body support-to-front hinge .....	300 ft-lbs (407 Nm) (41 kgm)
Sound-Gard Body retaining cap screws .....	150 ft-lbs (203 Nm) (20 kgm)
Retaining cap screw to lock nut .....	170 ft-lbs (230 Nm) (23 kgm)
Rear hinge-to-torque divider .....	350 to 400 ft-lbs (474 to 542 Nm) (47 to 54 kgm)
Torque Divider	
Torque divider-to-transmission .....	300 ft-lbs (407 Nm) (41 kgm)
Tie rods (torque divider-to-rockshaft) .....	100 ft-lbs (136 Nm) (14 kgm)

### SPECIAL TOOLS

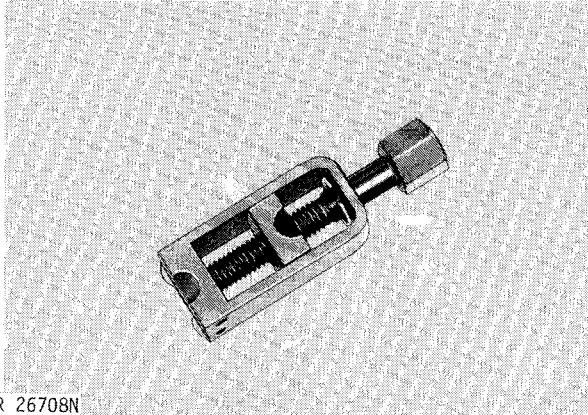
#### Predelivery, Delivery, and After-Sale Services

**TOOL**

**USE**

JDG-18 Snap Ring Tool\*

Remove and install snap rings on ends of rear axles



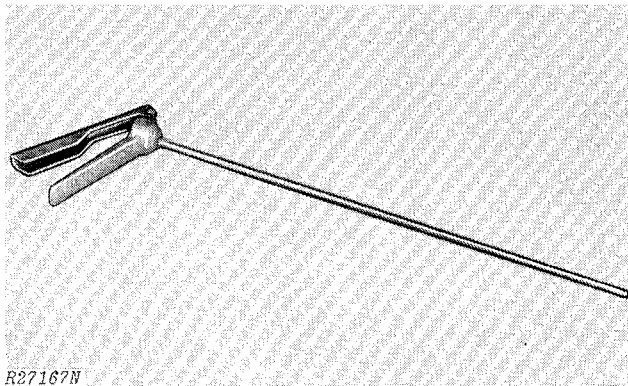
R 26708N

Fig. 1-JDG-18 Snap Ring Tool

#### Tune-Up

AR62377 Dry Element Cleaning Gun

Clean primary element of air cleaner

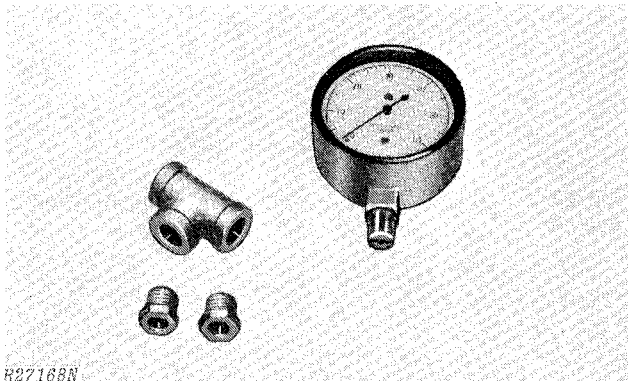


R27167N

Fig. 2-AR62377 Dry Element Cleaning Gun

D-05022ST Water Vacuum Gauge\*

Measure air intake vacuum



R27168N

Fig. 3-D-05022ST Water Vacuum Gauge (Formerly JDST-11)

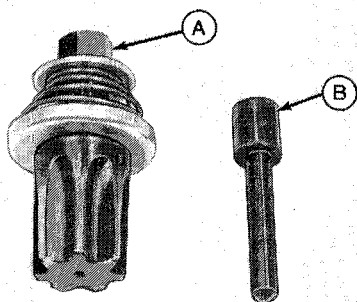
\*Order from Service Tools, Box 314, Owatonna MN 55060

**SPECIAL TOOLS—Continued**

TOOL

NUMBER

USE



A-JDE-81-1 Engine Rotation Tool\*

Turn engine to TDC to check injection pump timing

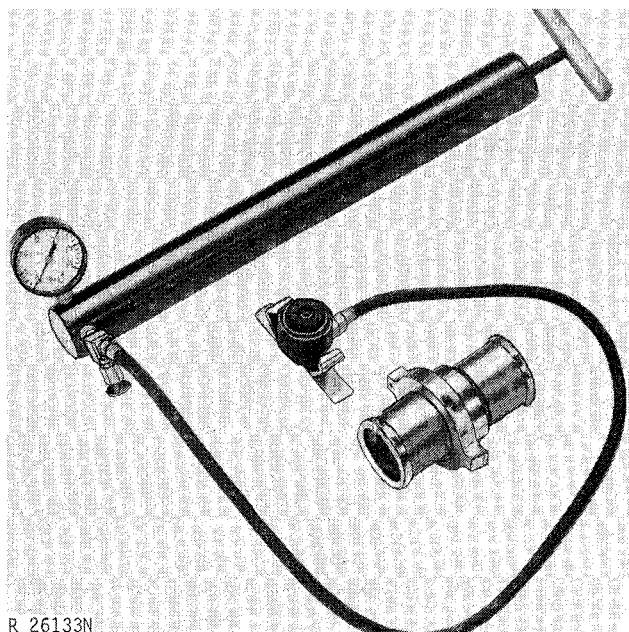
B-JDE-81-4 Timing Pin\*

R 26134N

Fig. 4-Tools Required for Checking Timing

D-05104ST Pressure Pump\*

Pressure test cooling system and radiator caps



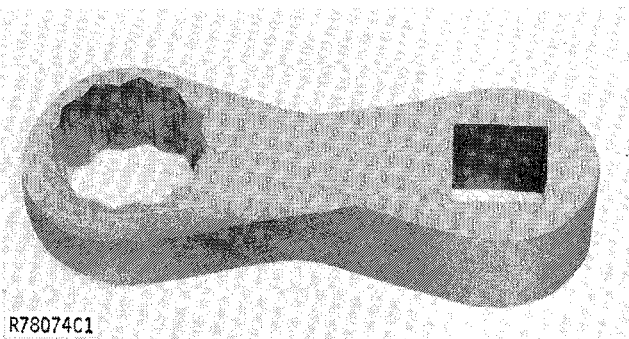
R 26133N

Fig. 5-D-05104ST Pressure Pump

**Separation**

JDT-46 Adapter\*

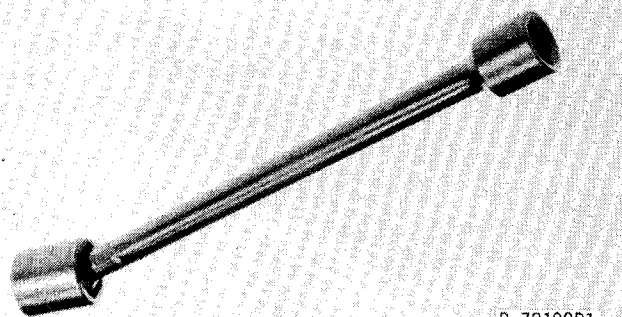
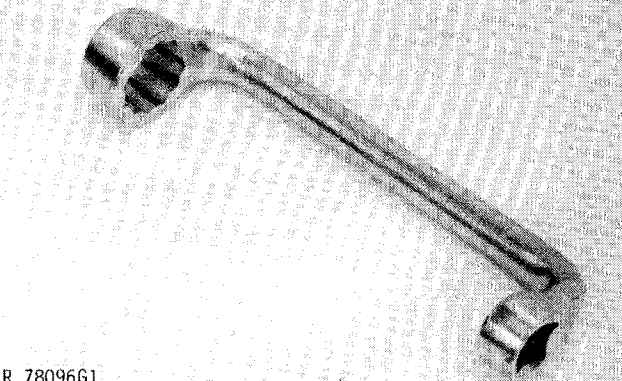
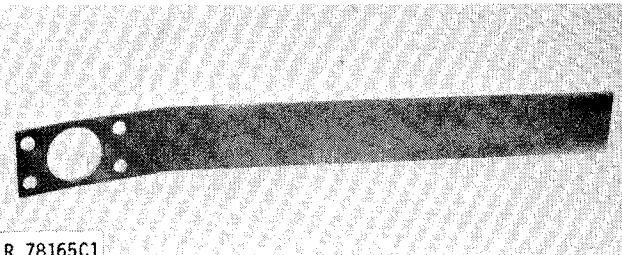
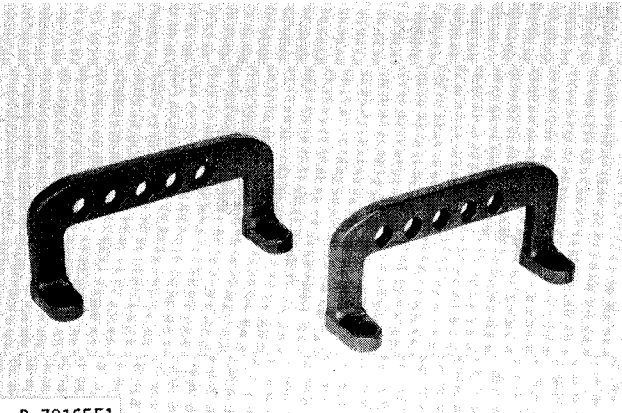
Remove or tighten torque divider cap screws.



R78074C1

Fig. 6-Special Torque Wrench Adapter

\*Order from Service Tools, Box 314, Owatonna MN 55060

TOOL	NUMBER	USE
 <p>R 78109D1</p> <p>Fig. 7-Special Torque Wrench Extension</p>	<p>JDE-16A Extension*</p>	<p>Remove or tighten hard to get at cap screws.</p>
 <p>R 78096G1</p> <p>Fig. 8-Special Wrench</p>	<p>JDE-36 Special Wrench*</p>	<p>Remove engine mount-to-front support cap screws.</p>
 <p>R 78165C1</p> <p>Fig. 9-Yoke Holding Tool</p>	<p>JDE-27 Yoke Holding Tool*</p>	<p>To hold drive shaft yokes while removing retaining nut.</p>
 <p>R 78165F1</p> <p>Fig. 10-Engine Lift Brackets</p>	<p>JDG-1-9 Engine Lift Brackets*</p>	<p>To remove engine from 8640.</p>

\*Order from Service Tools, Box 314, Owatonna MN 55060

**SPECIAL TOOLS—Continued**

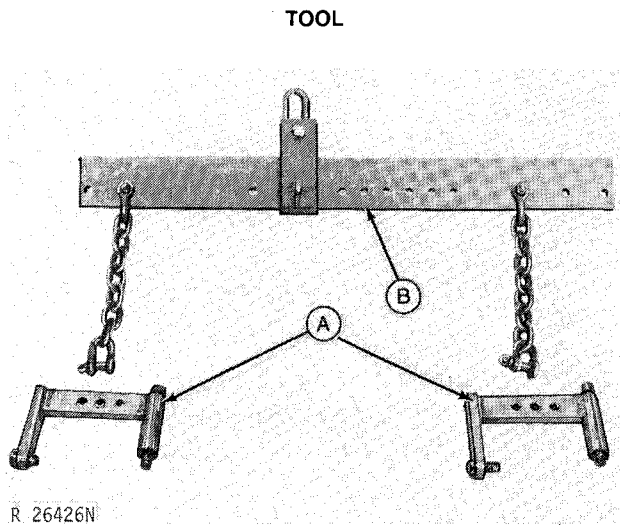


Fig. 11-Engine Removal Tools

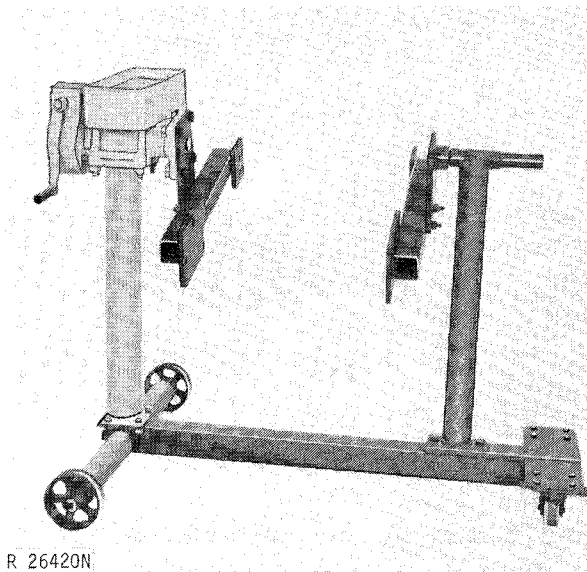


Fig. 12-Engine Repair Stand

D-05001ST  
Repair Stand\*

To support engine after  
removal.

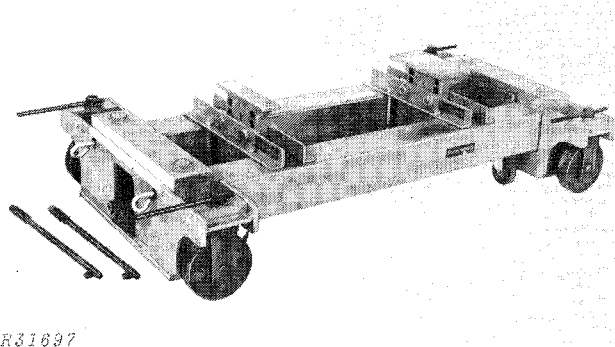


Fig. 13-Rear Splitting Stand

D-05150ST  
Heavy Duty Rear  
Splitting Stand\*

To support tractor.

\*Order from Service Tools, Box 314, Owatonna MN 55060

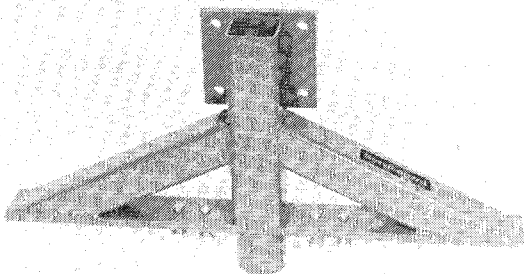
**TOOL**

**NUMBER**

**USE**

D-05153ST  
Lifting Bracket\*

To support front of tractor.

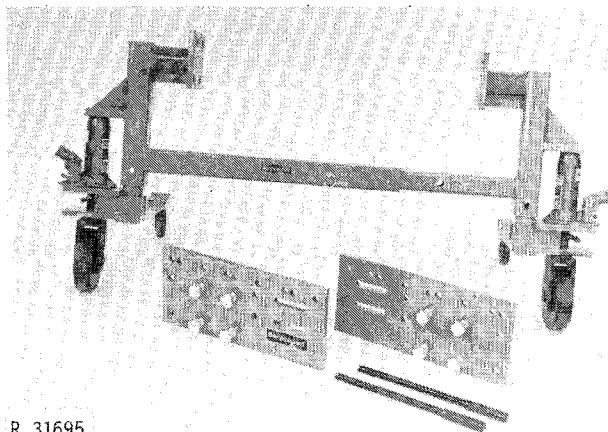


R 31696

Fig. 14-Lifting Bracket

D-05151ST  
Heavy Duty Front  
Splitting Stand\*

To support front of tractor.

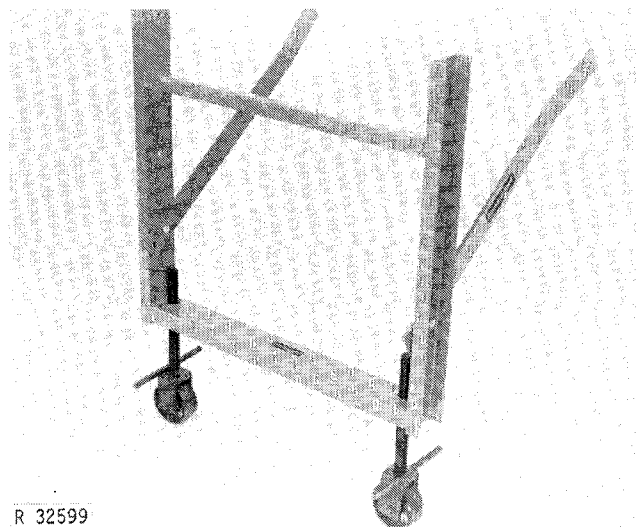


R 31695

Fig. 15-Front Splitting Stand

D-05152ST  
Front Support\*

Supports front of tractor to  
prevent tipping.



R 32599

Fig. 16-Front Support

\*Order from Service Tools, Box 314, Owatonna MN 55060

**SPECIAL TOOLS—Continued**

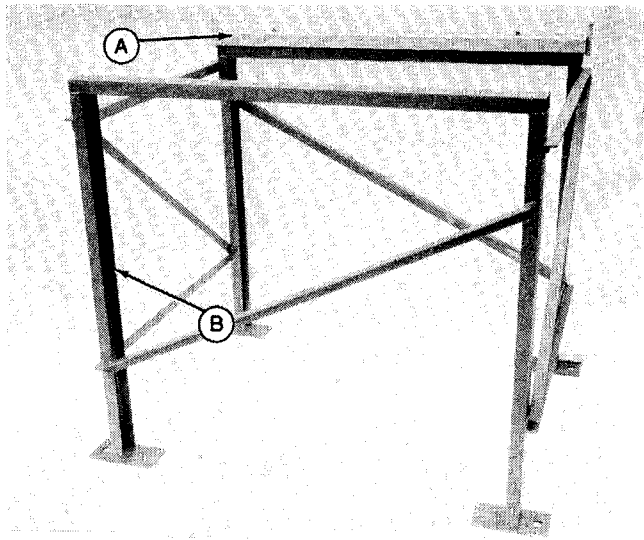
TOOL	NUMBER	USE
 <p>R 7812281</p>	<p>A-JDG-14 Adapter*</p> <p>B-JDG-10-2 Sound-Gard Body Support Stand*</p>	<p>To support Sound-Gard Body after removal.</p>

Fig. 17-Sound-Gard Body Supports

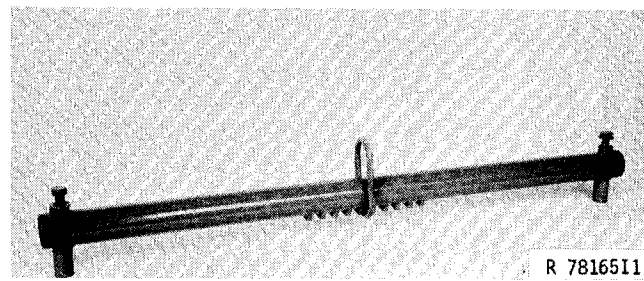


Fig. 18-Lifting Bracket

JDG-15

To lift Sound-Gard Body

\*Order from Service Tools, Box 314, Owatonna MN 55060

## Group 05

# PREDELIVERY, DELIVERY, AND AFTER-SALE SERVICES

### Explanation of Predelivery and Delivery Services

The John Deere Delivery Receipt, when properly filled out and signed by the dealer and customer, verifies that the predelivery and delivery services were satisfactorily performed. When delivering this machine, give the customer his copy of the delivery receipt and the operator's manual. Explain their purpose to him.

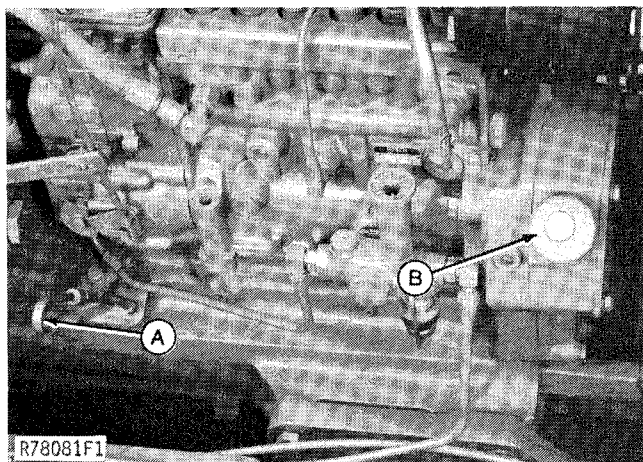
Because of the shipping factors involved, plus extra finishing touches that are necessary to promote customer satisfaction, proper predelivery service is of prime importance to the dealer.

A tag pointing out the factory-recommended procedure for predelivery service is attached to each new tractor before it leaves the factory.

After completing the factory-recommended dealer checks and services listed on the predelivery tag, remove the tag from the tractor and file it with the shop order for the job. The tag will certify that the tractor has received the proper predelivery service when that portion of the customer's John Deere Delivery Receipt is completed.

### PREDELIVERY SERVICE BEFORE STARTING TRACTOR

#### Checking Engine Oil Level



A—Dipstick

B—Filler Cap

Fig. 1-Engine Oil Dipstick and Filler Cap

*NOTE: Tractor should be on a level surface when oil level is checked. If it is not, check only to make sure the crankcase is not dry. Recheck oil level later, when tractor is on level ground.*

1. Remove engine oil dipstick (A, Fig. 1) and check oil level.
2. If necessary, add sufficient oil to bring oil level to full mark on dipstick.
3. When adding oil, use John Deere TORQ-GARD® SUPREME SAE 10W-20 or its equivalent.

#### Checking Coolant Level

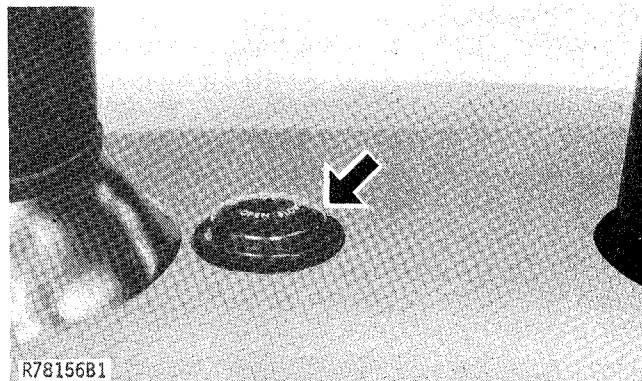
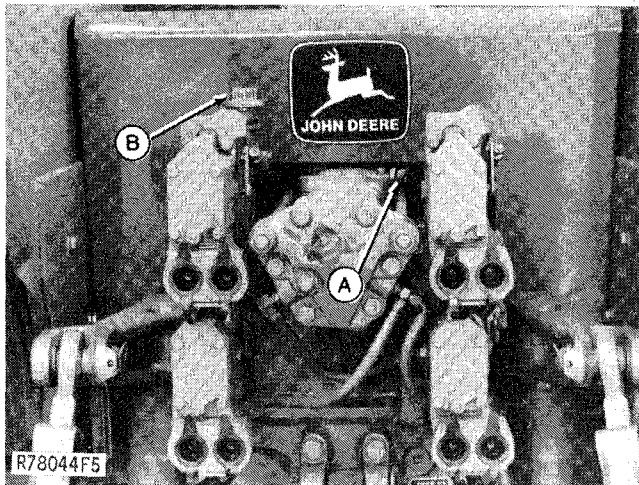


Fig. 2-Radiator Filler Cap

1. Remove radiator filler cap (Fig. 2) and check coolant level. Coolant should be at least 1/2 inch (13 mm) above baffle in radiator top tank on an 8640 Tractor and 1-1/2 inches (38 mm) above baffle in radiator top tank on an 8440 Tractor.
2. If necessary, add coolant to obtain this level. Use permanent type ethylene glycol antifreeze which contains a rust inhibitor but does not contain a stop-leak additive.

## PREDELIVERY SERVICE—Continued

### Checking Transmission-Hydraulic System Oil Level



A—Dipstick

B—Filler Cap

Fig. 3—Transmission-Hydraulic System Dipstick

1. With the tractor on level ground, start engine and idle at approximately 1200 rpm for 10 minutes. Check the transmission-hydraulic system oil level with the dipstick (A, Fig. 3).

2. Make sure oil level is up to full mark on dipstick.

3. If necessary, remove filler cap (B) and add John Deere HY-GARD® Transmission and hydraulic oil or its equivalent.

### Connect Starting Fluid Solenoid Wiring



Fig. 4—Starting Fluid Wiring Connector

Starting fluid solenoid wiring is not connected. If necessary, attach connector to solenoid (Fig. 4).

### Lubrication

**CAUTION:** Be sure that the engine is shut off and the key removed before working in the hinge area.

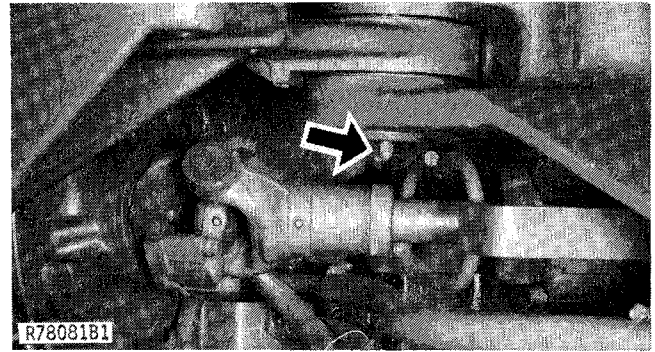


Fig. 5—Upper Hinge Pin Grease Fitting

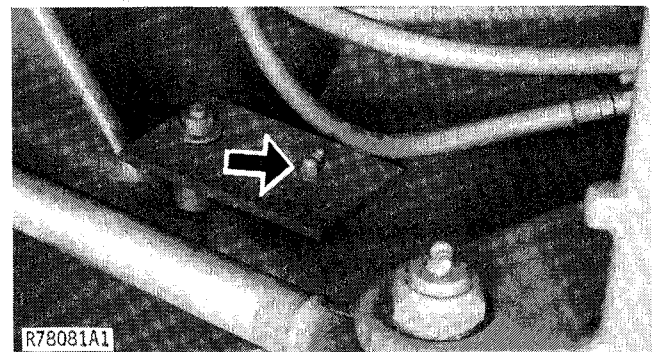


Fig. 6—Lower Hinge Pin Grease Fitting

Apply several shots of John Deere Multi-Purpose Lubricant or its equivalent at the upper and lower hinge pivot pin grease fittings (Figs. 5 and 6).

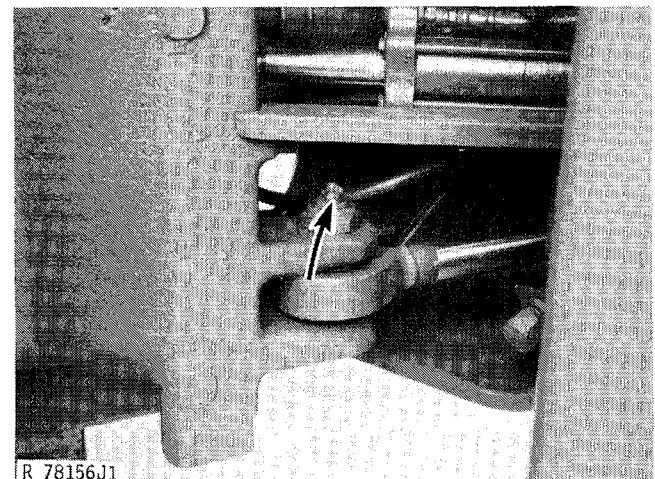


Fig. 7—Steering Cylinder Rear Pivot Pins

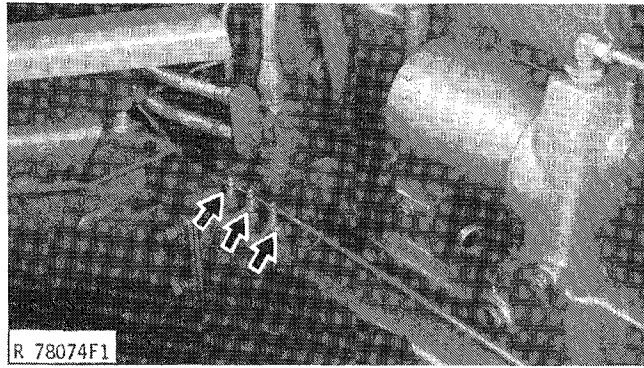


Fig. 8-Remote Grease Fittings for Steering Cylinder Front Pivot Pins

Lubricate the steering cylinder pivot pins at the ends of the three steering cylinders. The rear fittings are accessible at the hinge area (Fig. 7). The front pivot pins are serviced by remote grease fittings on the right hand tractor frame (Fig. 8).

Place the tractor in a full turn. This prevents grease buildup which might damage slip joints.

**CAUTION:** Stop the engine and remove the key before working in the hinge area.

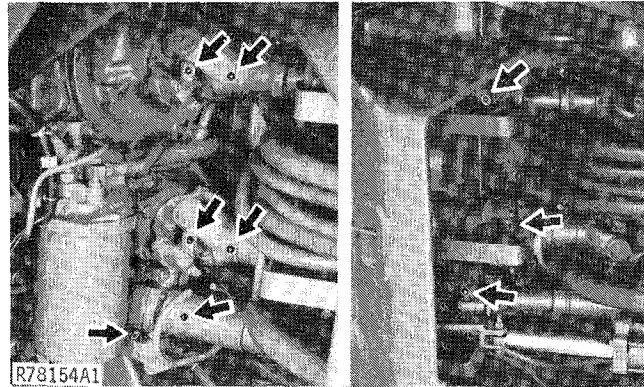


Fig. 9-Hinge Area Grease Fittings (Front and Rear)

Apply 5 shots of grease to the slip joints. Grease the universal joints until grease appears at the seals. Use John Deere Multi-Purpose Lubricant or its equivalent.

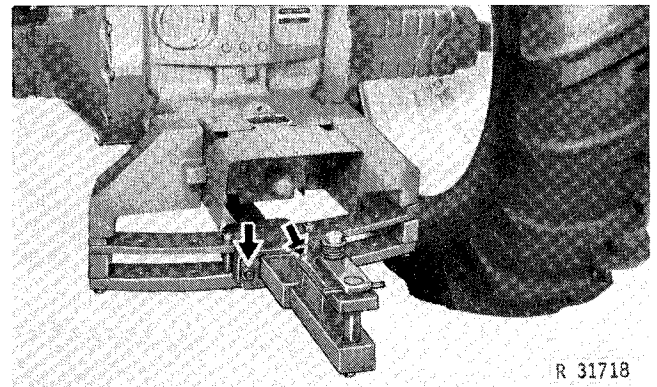


Fig. 10-Wide-Swing Drawbar Grease Fittings

Lubricate the wide-swing drawbar rollers (Fig. 10) with several shots of John Deere Multi-Purpose Lubricant or its equivalent.

## Wheels and Tires

### Adjusting Tire Pressure

Tires are overinflated for shipping. To avoid risk of tire damage, reduce inflation pressure before driving tractor.

#### INFLATION CHART

Tire Size	Ply Rating	*With Little or No Added Ballast	With Maximum Ballast or Heavy Rear-Mounted Implement
18.4-34	6	16 psi (1.1 bar)	16 psi (1.1 bar)
18.4-34	8	16 psi (1.1 bar)	20 psi (1.4 bar)
18.4-38	6	16 psi (1.1 bar)	16 psi (1.1 bar)
18.4-38	8	16 psi (1.1 bar)	20 psi (1.4 bar)
20.8-34	6	14 psi (1.0 bar)	14 psi (1.0 bar)
20.8-34	8	16 psi (1.1 bar)	18 psi (1.2 bar)
20.8-38	8	16 psi (1.1 bar)	18 psi (1.2 bar)
23.1-30	8	16 psi (1.1 bar)	16 psi (1.1 bar)
23.1-34	8	16 psi (1.1 bar)	16 psi (1.1 bar)
24.5-32	10	18 psi (1.2 bar)	20 psi (1.4 bar)
30.5-32	10	16 psi (1.1 bar)	16 psi (1.1 bar)

*\*This indicates the minimum inflation pressure for single tires. Absolute minimum pressure for double tires is 12 psi (0.8 bar).*

### Wheels and Tires—Continued

#### Adjusting Tread Width

The front and rear wheel tread may be adjusted by moving the wheel on the axle with the rack and pinion or by changing the position of the rim on the wheel.

The following chart gives the usable tread width for each tire size available.

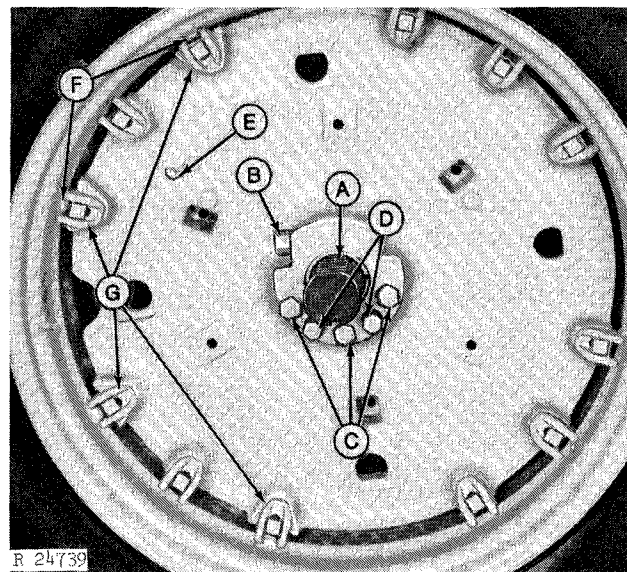
**CAUTION:** Single wheel tread settings of less than 80 inches (2.03 m) are provided ONLY to conform to highway and transport regulations. For single wheel operation, tread settings of 80 inches (2.03 m) or more with 1000 pounds (454 kg) ballast on each wheel must be used.

With single wheels, limit tread to not more than 110 inches (2.79 m) when pulling heavy loads in transmission range "A".

Tire Size	Short Axles		Long Axles	
	Minimum	Maximum	Minimum	Maximum
23.1-30			65	75
(Inside)			(1.65)	(1.91)
23.1-30			120	130
(Outside)			(3.05)	(3.30)
23.1-30			65	81
(Inside)			(1.65)	(2.06)
18.4-34			115	131
(Outside)			(2.92)	(3.33)
18.4-34	63	67	63	83
(Inside)	(1.60)	(1.70)	(1.60)	(2.11)
18.4-34		108	108	124
(Outside)		(2.74)	(2.74)	(3.15)
20.8-34			63	81
(Inside)			(1.60)	(2.06)
20.8-34			114	124
(Outside)			(2.90)	(3.15)
23.1-34			66	70
(Inside)			(1.67)	(1.18)
23.1-34			124	129
(Outside)			(3.15)	(3.28)
18.4-38	63	67	63	83
(Inside)	(1.60)	(1.70)	(1.60)	(2.11)
18.4-38		111	114	134
(Outside)		(2.82)	(2.90)	(3.40)
20.8-38			72	76
(Inside)			(1.83)	(1.93)
20.8-38			120	129
(Outside)			(3.05)	(3.28)
24.5-32			66	Only
(Inside)			(1.67)	
24.5-32			122	Only
(Outside)			(3.10)	

#### SINGLE TIRES

Tire Size	Short Axles		Long Axles	
	Minimum	Maximum	Minimum	Maximum
23.1-30	80	95	80	116
	(2.03)	(2.41)	(2.03)	(2.95)
24.5-32	80	99	Not Recommended	
	(2.03)	(2.51)		
30.5-32	80	105	Not Recommended	
	(2.03)	(2.67)		
20.8-34	80	93	80	124
	(2.03)	(2.36)	(2.03)	(3.15)
23.1-34	80	95	80	116
	(2.03)	(2.41)	(2.03)	(2.95)
20.8-38	80	93	80	124
	(2.03)	(2.36)	(2.03)	(3.15)



**A—Rack**  
**B—Pinion**  
**C—Special Bolts**  
**D—Jack Screws**  
**E—Weight Reference Mark**  
**F—Rim Driving Lugs**  
**G—Wheel Driving Lugs**

Fig. 11-Rack and Pinion Wheel

Adjust tread width to customer's needs as follows:

1. Jack up tractor. Rotate wheel so that rack is on top of axle.
2. If needed, clean axle with a steel brush.
3. Loosen the three special bolts (C, Fig. 11) approximately 3/8 inch (10 mm) each.
4. Tighten the two jack screws (D) evenly until key sleeve loosens.

*NOTE: If sleeve is difficult to break loose, also loosen the three special bolts on inboard side of wheel. If sleeve still will not break loose, strike end of axle several times with a heavy hammer and evenly re-tighten jack screws. It helps to soak sleeves with penetrating oil.*

5. Turn pinion (B) to slide wheel in or out on axle to desired position. For extreme tread positions, it may be necessary to reverse wheel on axle or change rim position on wheel.

**IMPORTANT: Tires or weights must have at least one inch (25 mm) clearance with fenders. To prevent damaging pinion when hub is tightened, do not put wheel in its very innermost position—back it out at least 1/8 inch (3 mm).**

6. Back jack screws all the way out against stop. Do not force.

7. Lubricate threads and tighten special bolts to 300 ft-lbs (410 Nm) (41 kgm). Retighten bolts several times until all three stay tightened to specified torque. Jack screws must be free to turn after hub is tightened. If necessary, loosen jack screws further and retighten special bolts.

**IMPORTANT: After driving tractor approximately 100 yards (100 m), retighten special bolts to proper torque. Instruct customer to retighten them after 3 hours work and again after 10 hours work, and to keep them tight.**

### Installing Hubs

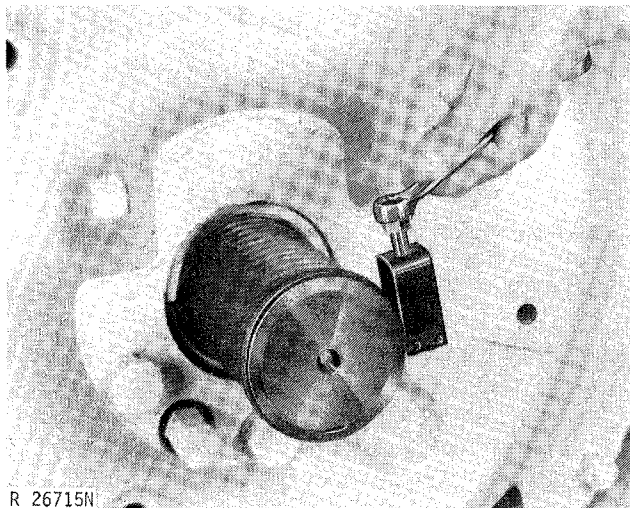


Fig. 12-Using JDG-18 Snap Ring Tool

1. If hubs are not installed, remove snap ring from end of axle. Use JDG-18 Snap Ring Tool as shown in Fig. 12.

2. Install wheel on axle and adjust tread to desired position. See tread adjustment instructions on page 7.

**IMPORTANT: Be sure gap between tires is at least four inches (100 mm).**

3. Install snap ring on end of axle.

### Functional Checks

#### Checking Air Cleaner Elements

1. Remove air cleaner cover.

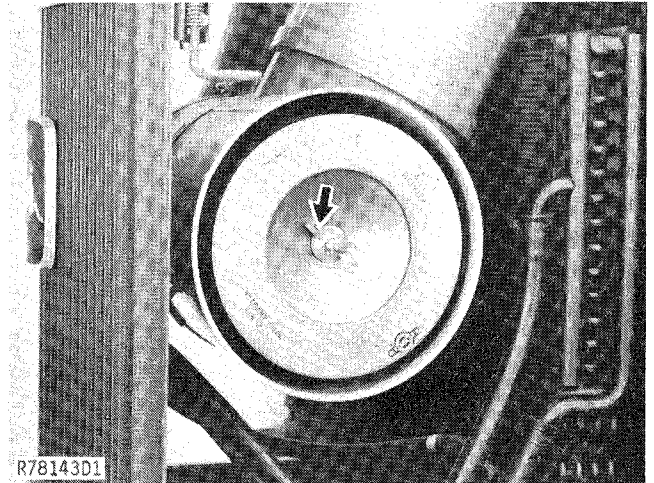


Fig. 13-Air Cleaner

2. Make sure elements are properly positioned in air cleaner housing.

3. When installing elements and cover, make sure wing nuts are securely tightened.

#### Checking Batteries

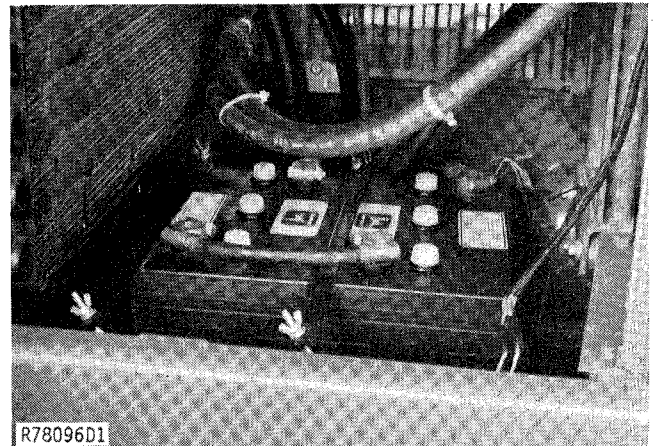


Fig. 14-Batteries

1. Pull down side grill screens.
2. Check level of electrolyte in each cell of each battery. Level should be to bottom of filler neck. If water is needed, use clean, mineral-free water.
3. Make sure all cables are tight.



### Checking Lamps

1. Check light operation at W, H (high beam), H (low beam), F (low beam), and F (high beam) positions as indicated below:

"W": Warning lamps

"H" and high beam: High beam indicator, instrument, console, warning, tail, head and front flood lamps.

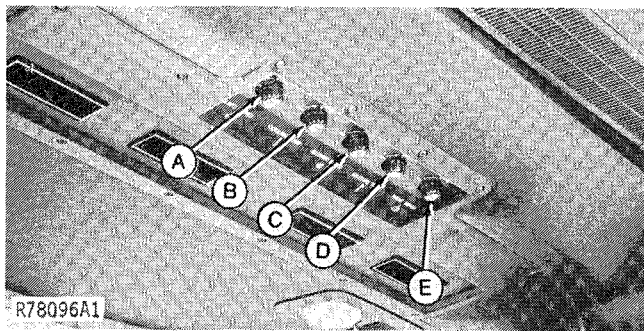
"H" and low beam: Instrument, console, warning, tail and head lamps.

"F" and low beam: Instrument, console, front flood, head, and lower rear flood lamps.

"F" and high beam: Instrument, console, high beam indicator, front flood, head, and all four rear flood lamps.

2. Adjust flood lamps outward.

### Checking Blowers and Wipers



A—Left-Hand Wiper Switch  
 B—Air Conditioning Temperature Switch  
 C—Blower Switch  
 D—Heater Temperature Control  
 E—Right-Hand Wiper Switch

Fig. 18—Sound-Gard Body Controls

1. With the key switch "on" check blower motor operation; slow, medium, and fast.

2. Wet windshield and check operation of windshield wipers.

3. Check tilt-telescope steering wheel operation.

4. Check window and door locks and latches.

### Driving Checks

1. Add enough fuel for driving checks and delivery to customer.

2. Make sure tractor can only be started in either "Neutral" or "Park" positions. If tractor can start in any other position, neutral start switch is defective. See Group 15 of Section 240.

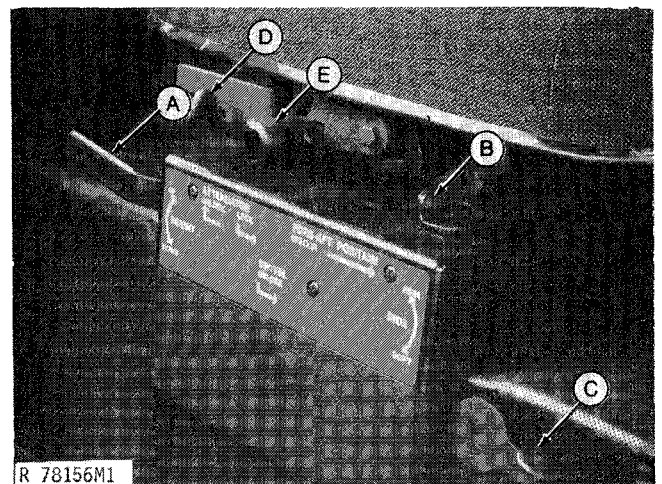
3. Check operation of differential lock, if equipped. While driving tractor, depress differential lock pedal. Pedal should release when foot is removed.

If differential lock does not function properly, refer to Group 25 of Section 250.

4. Make sure brake pedal has a solid feel for at least five applications after engine has been stopped for at least 15 minutes. If any problem is found (excessive pedal travel, no solid feel), refer to Group 10 of Section 260.

With engine on, make sure pedal travel does not exceed 3 in. (80 mm).

5. Check steering by first driving tractor in a straight line. Make sure tractor does not wander to left or right. Check steering; full turn left and full turn right.



A—Height Adjustment Lever      D—Attenuator Lock  
 B—Fore-Aft Adjustment Lever    E—Swivel Lock  
 C—Ride Adjustment Lever

Fig. 19—HYDRACUSHIONED™ Seat Controls

6. Check all seat controls (Fig. 19) to make sure they function properly. If and problem is found, refer to Group 10 of Section 270.

## Driving Checks—Continued

7. Check heater operation, if equipped, by turning temperature control knob (D, Fig. 18) to warmest temperature, and checking air at outlet.

8. With the key switch on, turn the air conditioning thermostatic switch (B, Fig. 18) toward maximum cooling and listen for audible click of compressor clutch engagement.

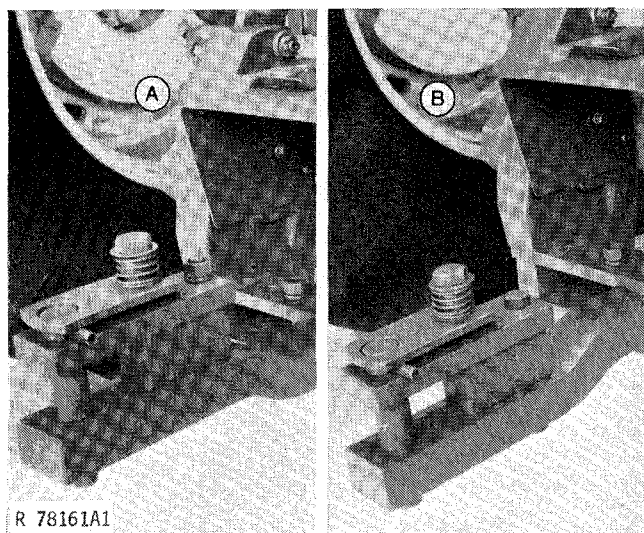
9. With engine running, pull throttle all the way rearward to slow idle. Observe tachometer. Engine speed should be 780 to 820 rpm.

Push throttle all the way forward to fast idle. Engine speed should be 2225 to 2325 rpm.

## HYDRAULIC AND IMPLEMENT HITCH FUNCTIONS

### Preparation

1. Remove retaining wire from lower lift arms.



A—Offset Up

B—Offset Down

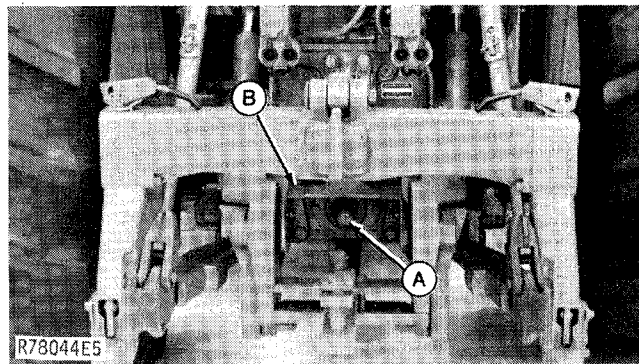
Fig. 20—Drawbar Positions

2. Place drawbar in proper position; (per customers needs) offset up, or offset down. Make sure clevis is on top of drawbar.

3. Check quick-coupler hooks and levers.
4. Remove PTO cover.

### Checking PTO Operation

1. Make sure PTO rotates with lever engaged and stops with lever disengaged.



A—PTO Guard

B—Master Shield

Fig. 21—Safety Shields

2. Make sure all safety shields (Fig. 21) are in place.

### Checking Rockshaft Operation

1. Raise and lower rockshaft several times to make sure it functions smoothly.
2. Make sure rockshaft does not settle from the raised position.

### Checking Selective Control Valves and Remote Cylinder Operation

1. Connect a remote cylinder to a breakaway coupler on a selective control valve.
2. Extend and retract cylinder several times.
3. Extend and retract cylinder slow and fast by adjusting the metering valve arm on selective control valve.
4. Make sure selective control valve lever returns to neutral when cylinder reaches end of its stroke.
5. Repeat steps 1 through 4 for each breakaway coupler.

### General

1. Remove SMV emblem plastic cover.
2. Clean tractor and touch-up paint.
3. Make overall appearance inspection.
4. Make deficiency report.
5. Familiarize customer with tractor and Operator's Manual.

## DELIVERY SERVICE

A thorough discussion of the operation and service of a new tractor at the time of delivery helps to assure complete customer satisfaction. Proper delivery should be an important phase of a dealer's program. A portion of the John Deere Delivery Receipt emphasizes the importance of proper delivery service.

Many complaints have arisen simply because the owner was not shown how to operate and service his new tractor properly. Enough time should be devoted, at the customer's convenience, to introducing the owner to his new tractor and explaining to him how to operate and service it.

**IMPORTANT: Install plug in muffler outlet if transporting tractor to customer. This will prevent damage to the turbocharger caused by air passing through the turbocharger and rotating it without lubrication when the engine is stopped.**

The following procedure is recommended before the serviceman and owner complete the delivery acknowledgments portion of the delivery receipt.

Using the tractor operator's manual as a guide, be sure the owner understands these points thoroughly:

1. Controls and instruments.
2. How to start and stop the engine.
3. The importance of the break-in period.
4. How to use liquid or cast-iron ballast.
5. All functions of the hydraulic system.
6. Using the power takeoff.
7. The importance of safety.
8. The importance of lubrication and periodic services.

Give particular emphasis to sway blocks, rockshaft speed-of-drop, rockshaft selector lever (load and depth control), transmission oil indicator light (whether temperature or pressure and what to do if it comes on), voltmeter (how to see whether alternator is charging), instrument audible warning system, and SOUND-GARD Body air filters. These areas are very often misunderstood.

After explaining and demonstrating the above features, have the owner sign the delivery receipt and give him the operator's manual.



**Suggest:**

**If the above button click is invalid.**

**Please download this document first, and then click the above link to download the complete manual.**

**Thank you so much for reading**

### AFTER-SALE INSPECTION

The purchaser of a new John Deere tractor is entitled to a free inspection within the warranty period after the equipment has been "run in". The terms of this after-sale inspection are outlined on the back of the John Deere Delivery Receipt.

The purpose of this inspection is to make sure that the customer is receiving satisfactory performance from his tractor. At the same time, the inspection should reveal whether the tractor is being operated, lubricated, and serviced properly.

If the recommended after-sale service inspection is followed, the dealer can eliminate a needless volume of service work by preventing minor irregularities from developing into serious problems later on. This will promote strong dealer-customer relations and present the dealer an opportunity to answer questions that may have arisen during the first few days of operation.

The following inspection program is recommended within the first 100 hours of tractor operation.

#### Cooling System

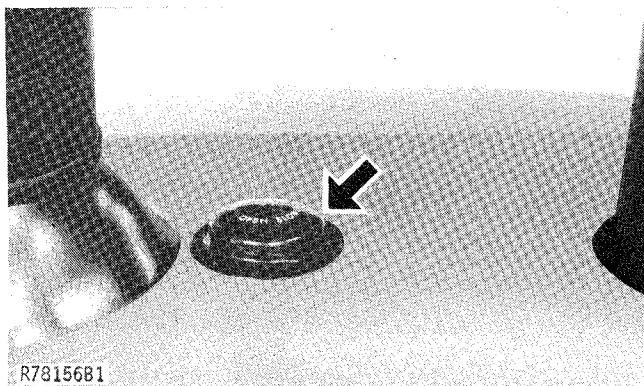
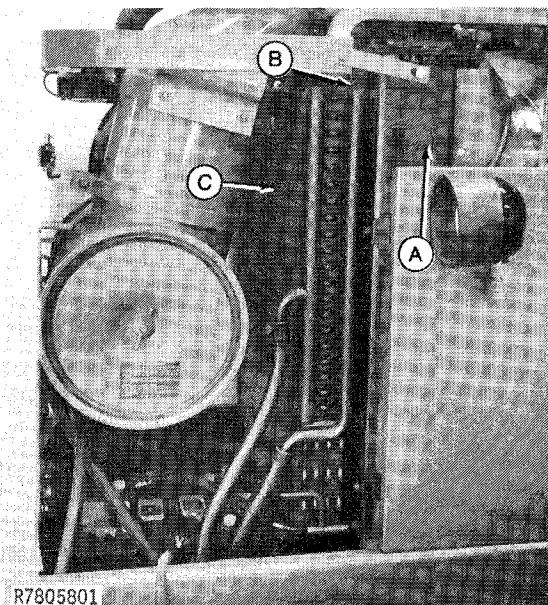


Fig. 22-Radiator Cap

1. Remove radiator cap and check coolant level. Level should be at least 1-1/2-inches (38 mm) above baffle in radiator top tank on an 8440 Tractor and 1/2 inch (13 mm) above baffle in radiator top tank on an 8640 Tractor. If coolant is low, fill to proper level and try to determine why coolant was lost.



A—Radiator  
B—Cap Screw  
C—Oil Cooler-Condenser

Fig. 23-Radiator and Oil Cooler-Condenser

2. Remove side grille screens. Remove any trash which has accumulated on radiator and oil cooler-condenser.

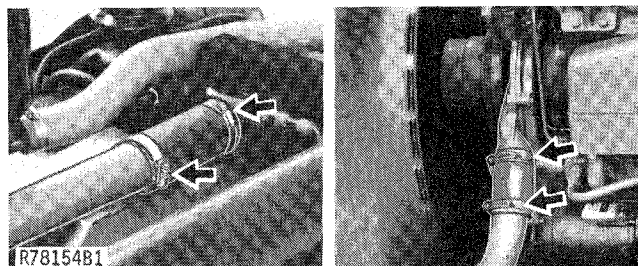


Fig. 24-Hose Clamps

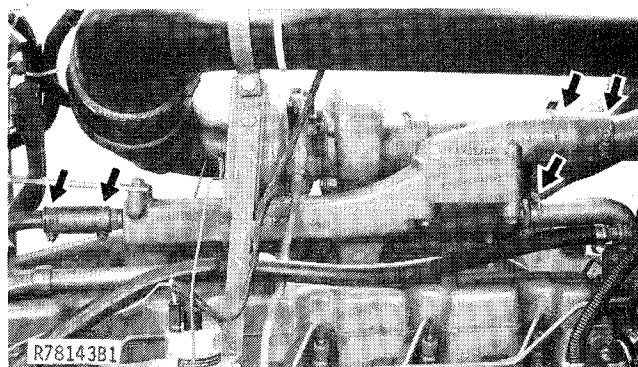


Fig. 25-Hose Clamps

3. Check all hoses and connections for leaks. Correct as necessary.

**<https://www.ebooklibonline.com>**

Hello dear friend!

Thank you very much for reading.

Enter the link into your browser.

The full manual is available for immediate download.

**<https://www.ebooklibonline.com>**