

7000 Folding Max-Emerge Planter



JOHN DEERE

TECHNICAL MANUAL 7000 Folding Max-Emerge Planter

TM1211 (01FEB85) English

John Deere Plow Planter Works
TM1211 (01FEB85)

LITHO IN U.S.A.
ENGLISH



7000 FOLDING MAX-EMERGE® PLANTER

TECHNICAL MANUAL

TM-1211 (FEB-85)

CONTENTS—REPAIR SECTIONS

SECTION 10 - GENERAL

- Group 05 - Specifications
- Group 10 - Predelivery, Delivery Service, and After-Sale Inspection
- Group 15 - Lubrication

SECTION 40 - ELECTRICAL REPAIR

- Group 05 - Specifications
- Group 10 - Console
- Group 15 - Master Cylinder Switches
- Group 20 - Junction Boxes

SECTION 70 - HYDRAULIC REPAIR

- Group 05 - Specifications and Tools
- Group 10 - Cylinders
- Group 15 - Flow Dividers
- Group 20 - Solenoid Valves

SECTION 100 - DRIVES REPAIR

- Group 05 - Specifications
- Group 10 - Drive Wheels
- Group 15 - Countershaft Drive System
- Group 20 - Seed Drive Transmission
- Group 25 - Seed Drive Shaft
- Group 30 - Fertilizer Drive

SECTION 110 - PLANTING UNIT REPAIR

- Group 05 - Seed Metering Mechanisms
- Group 10 - Seed Openers
- Group 15 - Closing Wheels

CONTENTS—OPERATION AND TEST SECTIONS

SECTION 240 - ELECTRICAL/HYDRAULIC OPERATION AND TEST

- Group 05 - Specifications
- Group 10 - Operation of 8-Row Wide and 12-Row Narrow
- Group 15 - Diagnosing and Testing 8-Row Wide and 12-Row Narrow
- Group 20 - Operation of 12-Row Wide, 16- and 18-Row Narrow
- Group 25 - Diagnosing and Testing 12-Row Wide, 16- and 18-Row Narrow
- Group 30 - Operation of 24-Row Narrow
- Group 35 - Diagnosing and Testing of 24-Row Narrow

SECTION 310 - PLANTING UNIT OPERATION AND TEST

- Group 05 - Seed Metering Mechanisms
- Group 10 - Seed Openers
- Group 15 - Closing Wheels
- Group 20 - Checking Row Unit Meters with Run-In Unit
- Group 25 - Checking Population

All information, illustrations and specifications contained in this manual are based on the latest information available at the time of publication. The right is reserved to make changes at any time without notice.

Because John Deere sells its products world-wide, U.S. units of measure are shown with their respective Metric equivalents throughout this technical manual. These equivalents are the SI (International System) Units of Measure.

NOTE: Monitor Sections 130 and 330 have been removed from this manual. Refer to TM-1270 for ALL planter monitoring system information.

Copyright© 1985 Deere & Company
Moline, Illinois All rights reserved
Previous Editions
Copyright© 1982 Deere & Company
Copyright© 1980 Deere & Company
Copyright© 1979 Deere & Company

INTRODUCTION

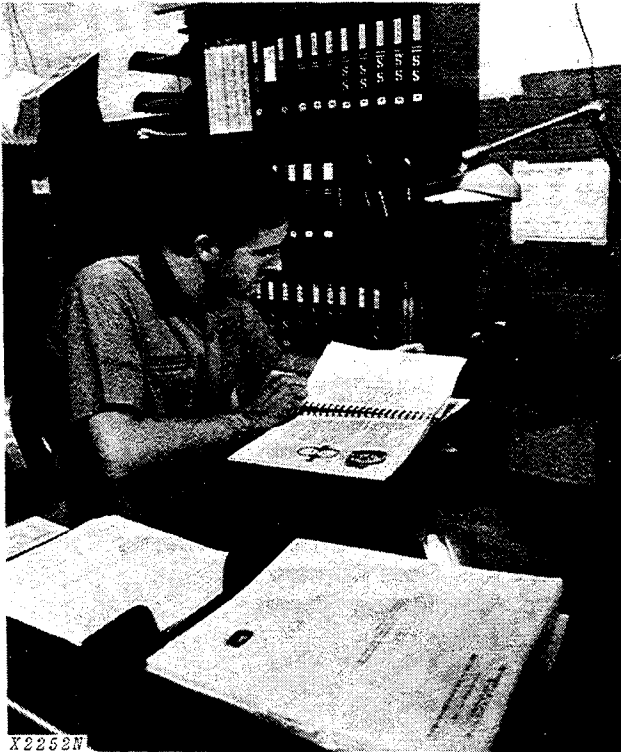

Use FOS Manuals for Reference

X2253N

This technical manual is part of a twin concept of service:

- **FOS Manuals—for reference**
- **Technical Manuals—for actual service**

The two kinds of manuals work as a team to give you both the general background and technical details of shop service.

Fundamentals of Service (FOS) Manuals cover basic theory of operation, *fundamentals* of trouble shooting, *general* maintenance, and *basic* types of failures and their causes. FOS Manuals are for training new people and for reference by experienced technicians.

Technical Manuals are concise service guides for a specific machine. Technical manuals are on-the-job guides containing only the vital information needed by an experienced technician.

NOTE: Whenever the service technician may need to refer to a FOS Manual for additional information, a specific manual, chapter and/or page number is given.



Use Technical Manuals for Actual Service

X2253N

Some features of this technical manual:

- *Table of contents at front of manual*
- *Exploded views showing parts relationship*
- *Photos showing service techniques*
- *Specifications grouped for easy reference*

This technical manual was planned and written for you—an experienced technician. Keep it in a permanent binder in the shop where it is handy. Refer to it whenever in doubt about correct service procedures or specifications.

Using the technical manual as a guide will reduce error and costly delay. It will also assure you the best in finished service work.



This safety alert symbol identifies important safety messages in this manual. When you see this symbol, be alert to the possibility of personal injury and carefully read the message that follows.

<https://www.ebooklibonline.com>

Hello dear friend!

Thank you very much for reading.

Enter the link into your browser.

The full manual is available for immediate download.

<https://www.ebooklibonline.com>

SAFETY AND YOU



T27999N

INTRODUCTION

 This safety alert symbol identifies important safety messages in this manual and on the planter. When you see this symbol, be alert to the possibility of personal injury and carefully read the message that follows.

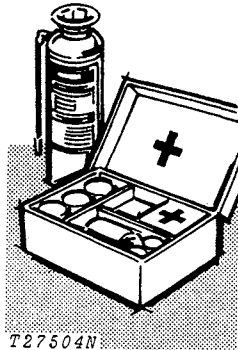

T27504N

Be prepared if an accident or fire should occur. Know where the first aid kit and the fire extinguishers are located—know how to use them.

SERVICE AREA

Keep the service area clean and dry. Wet or oily floors are slippery. Wet spots can be dangerous when working with electrical equipment.

Make sure the service area is adequately vented.

Be sure all electrical outlets and tools are properly grounded.

Use adequate light for the job at hand.

Protect Against Noise

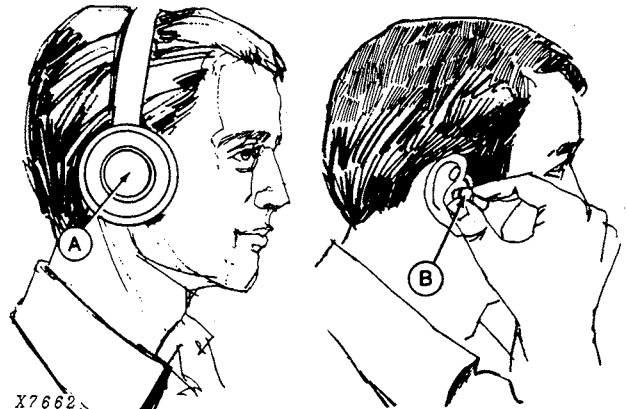

X7662

A—Earmuffs

X7062

B—Earplugs

Prolonged exposure to loud noise can cause impairment or loss of hearing.

Wear a suitable hearing protective device such as earmuffs (A) or earplugs (B) to protect against objectionable or uncomfortable loud noises.

SERVICE

Always lower the planter to the ground when not in use. Whenever possible, perform service work and adjustments with the planter on the ground.

Never clean, lubricate, or adjust a machine that is in motion.

TRANSPORTING

When transporting the planter on a smooth surface road, do not exceed maximum tractor transport speed. Reduce speed considerably when traveling over rough ground.

When transporting the planter on a road or highway at night or during the day, use accessory lights and devices for adequate warning to operators of other vehicles. In this regard, check local governmental regulations. Various safety lights and devices are available from your John Deere dealer.

AVOID HIGH-PRESSURE HYDRAULIC FLUIDS

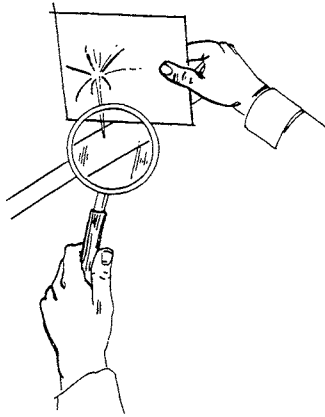

H05336

Escaping fluid under pressure can have sufficient force to penetrate the skin, causing serious personal injury. Before disconnecting lines, be sure to relieve all pressure. Before applying pressure to the system, be sure all connections are tight and that lines, pipes and hoses are not damaged. Hydraulic oil escaping from a very small hole can be almost invisible. Use a piece of cardboard or wood, rather than hands, to search for suspected leaks.

If injured by escaping fluid, see a doctor at once. Serious infection or reaction can develop if proper medical treatment is not administered immediately.

Always relieve pressure in the hydraulic system before working with hydraulic system components.

PERSONAL SAFETY

RIGHT



H23440N

H23440N

Always avoid loose clothing or any accessory—flopping cuffs, dangling neckties and scarves—that can catch in moving parts and put you out of work. Always wear your safety glasses while on the job.

MOUNTING TIRES

Failure to follow proper procedures when mounting a tire on a wheel or rim can produce an explosion which may result in serious injury or death. Do not attempt to mount a tire unless you have the proper equipment and experience to perform the job. Have it done by your John Deere dealer or a qualified tire repair service.

When sealing tire beads on rims, never exceed 35 psi or maximum inflation pressures specified by tire manufacturers for mounting tires. Inflation beyond this maximum pressure may break the bead, or even the rim, with dangerous explosive force. If both beads are not seated when the maximum recommended pressure is reached, deflate, reposition tire, relubricate bead, and reinflate.

Detailed agricultural tire mounting instructions, including necessary safety precautions, are contained in John Deere Fundamentals of Service (FOS) Manual 55, Tires and Tracks, available through your John Deere dealer. Such information is also available from the Rubber Manufacturers Association and from tire manufacturers.

Section 10 GENERAL

CONTENTS

	Page		Page
Group 05 - SPECIFICATIONS		Group 15 - LUBRICATION	
General	05-1	Lubrication	15-1
Serial Number	05-1		
Group 10 - PREDELIVERY, DELIVERY, AND AFTER-SALES SERVICE			
Torque Chart	10-1		
Predelivery Service	10-1		
Delivery Service	10-2		
After-Sales Inspection	10-2		
Planter Run-In	10-3		

Group 05 SPECIFICATIONS

GENERAL

- PLANTING UNIT TYPES Plate or Plateless.
- SEED OPENERS Tru-Vee double-disk openers.
- ROW SPACING 8-Row Wide - 36- and 38-in. (91 cm and 97 cm) row widths.
12-Row Narrow - 30-in. (76 cm) row widths.
12-Row Wide - 36- and 38-in. (91 cm and 97 cm) row widths.
16-, 18- and 24-Row Narrow - 30-in. (76 cm) row widths.
- TYPE OF LIFT Wheel hydraulic cylinders.
- TYPE OF DRIVE Sprocket and chain from drive wheels.
- TIRES 8-Row Wide 7.60-15 6PR rib implement type.
12-Row Narrow 7.60-15 8PR rib implement type.
12-Row Wide, 16- and 18-Row Narrow 7.50-20 6PR rib implement type.
24-Row Narrow 7.50-20 6PR and 9-16 10PR rib implement type.
- SEED HOPPERS 1.6 bu. (58 L) or 3.0 bu. (106 L) capacity.
- MARKERS Automatic alternating or manual controlled.
- MONITORS 8-Row Wide and 12-Row Narrow - COMPUTER TRAK™ 100
12-Row Wide and 16-Row Narrow - COMPUTER TRAK 200
18- and 24-Row Narrow - COMPUTER TRAK 300

SERIAL NUMBERS

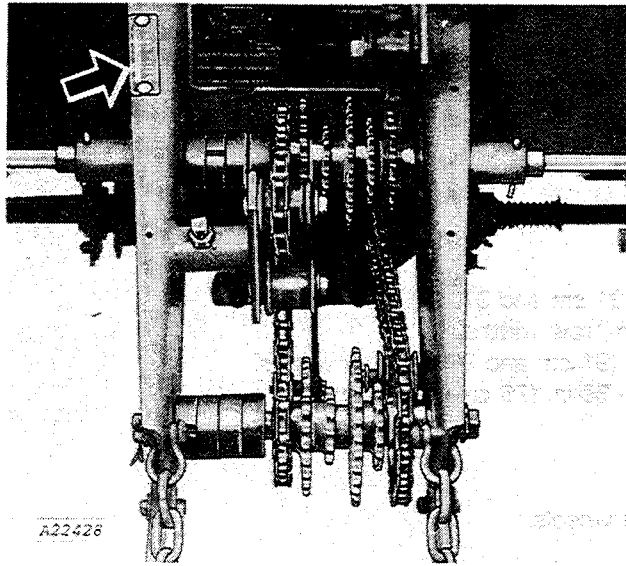

Fig. 1-8-Row Wide and 12-Row Narrow

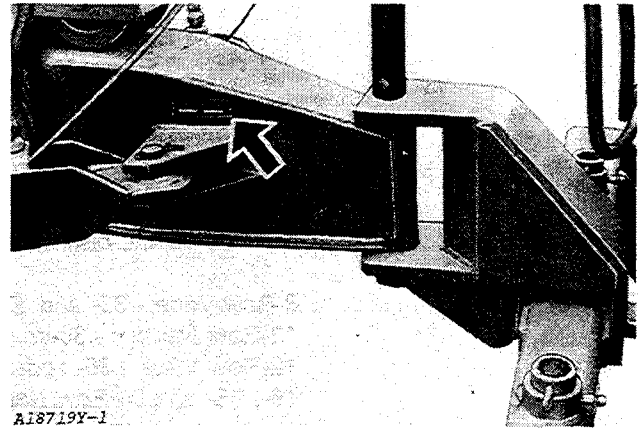

Fig. 2-12-Row Wide, 16-, 18- and 24-Row Narrow

Group 10 PREDELIVERY, DELIVERY, AND AFTER-SALE SERVICES

PREDELIVERY SERVICE

Planter Main Frame

Check drive wheels to be certain they are assembled properly and that they turn without binding.

Be certain chain guards and shields are properly installed.

Be certain that chain idlers pivot freely.

Check all chains for proper tension.

Check all grease fittings to be certain none have been broken in shipment.

Lubricate the planter as outlined in Section 10, Group 15.

Be certain planter tires are properly inflated.

Check all hardware to be certain it is tight. See torque chart at left.

Paint any parts which may have become scratched or faded during storage or shipment. Replace any damaged decals.

Raise and lower the planter to be certain planter lift system is working properly, and to be sure there are no interferences.

The John Deere Delivery Receipt, when properly filled out and signed by the dealer and customer, verifies that the predelivery and delivery services were satisfactorily performed. When delivering this machine, give the customer a copy of the delivery receipt and the operator's manual. Explain their purpose.

Because of the shipping factors involved, plus extra finishing touches that are necessary to promote customer satisfaction, proper predelivery service is of prime importance to the dealer.

After completing the factory-recommended dealer checks and services listed on the predelivery insert page, remove the page from the operator's manual and file it with the shop order for the job. The page will certify that the planter has received the proper predelivery service when that portion of the customer's John Deere Delivery Receipt is completed.

TORQUE CHART



Bolt Diameter "A"	Bolt Torque in Ft-Lbs (N·m)		
	SAE 2	SAE 5	SAE 8
3/8"	23 (31)	35 (47)	50 (68)
7/16"	35 (47)	55 (75)	80 (108)
1/2"	55 (75)	85 (115)	120 (163)
9/16"	75 (102)	130 (176)	175 (237)
5/8"	105 (142)	170 (231)	240 (325)
3/4"	185 (251)	300 (407)	425 (576)
7/8"	180 (217)	445 (603)	685 (929)
1"	250 (339)	670 (910)	1030 (1396)
1-1/4"	330 (450)	910 (1235)	1460 (1979)

NOTE: Bolts having lock nuts with plated finish should be tightened to approximately 50% of amounts shown in above chart.

Machine bolts and cap screws 7/8-in. and larger are sometimes formed hot rather than cold, which accounts for the lower torque.

DELIVERY SERVICE

A thorough discussion of the operation and service of a new planter at the time of delivery helps to assure complete customer satisfaction. Proper delivery should be an important phase of a dealer's program.

Many complaints arise simply because the owner is not shown how to operate, adjust and service the new planter properly. Enough time should be devoted, at the customer's convenience, to introducing the new planter and explaining how to operate, adjust, and service it.

Use the operator's manual as a guide to be sure the owner understands these points thoroughly.

1. The importance of safety.
2. The importance of lubrication and periodic service.
3. All planter functions and adjustments.
4. Transporting the planter.

AFTER-SALE INSPECTION

The purchaser of a new John Deere Planter is entitled to an inspection by the dealer at some mutually agreeable time within the warranty period.

The purpose of this inspection is to make certain that the customer is receiving satisfactory performance from the planter. The inspection should reveal whether or not the planter is being operated, lubricated, and serviced properly.

With this recommended after-sale service inspection, you may eliminate needless service work by preventing minor irregularities from developing into serious problems later. This will promote strong dealer-customer relations and present you with an opportunity to answer questions that may have arisen.

Use this inspection period to acquaint the customer with any special attachments which will help him to do a better job with his machine.

PLANTER RUN-IN

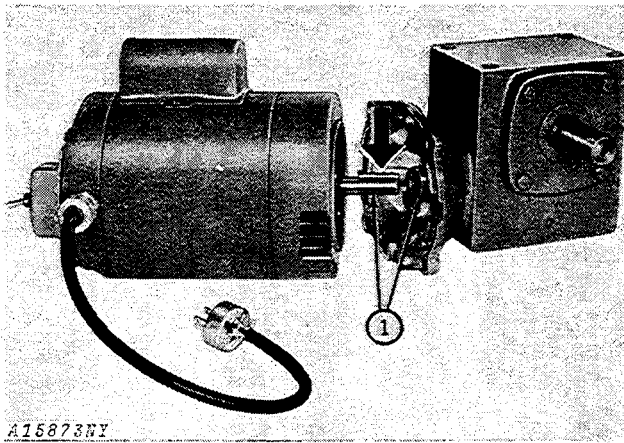

Fig. 1-Motor and Reducer

1. Align key on motor shaft with keyway in gear reducer and install run-in motor shaft in gear reducer.

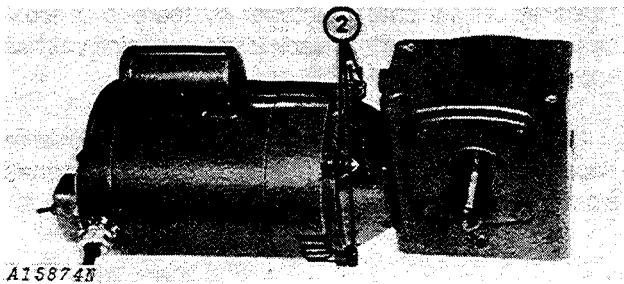

Fig. 2-Motor-Reducer Assembly

2. Bolt run-in unit motor to gear reducer as shown.

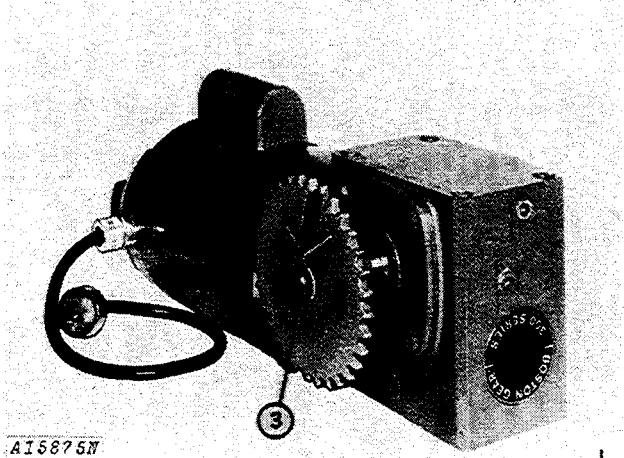
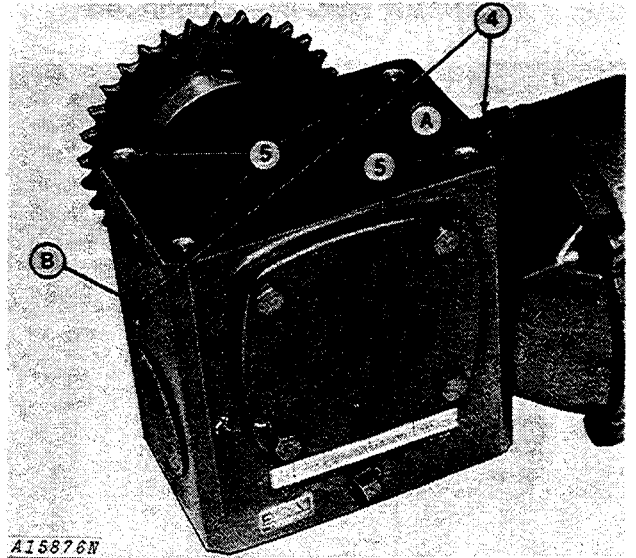

Fig. 3-32-Tooth Drive Sprocket

3. Install 32-tooth sprocket and key on gear reducer shaft.



A—Oil Filler Vent Plug

B—Oil Level Plug

Fig. 4-Oil Plugs

4. Remove oil filler vent plug (A, Fig. 4) and oil level plug (B) from gear reducer.

NOTE: Gear reducer is shipped without oil.

Fill gear reducer with SAE 90 oil at "A" until oil runs out oil level hole at "B".

5. Remove plugs from gear reducer.

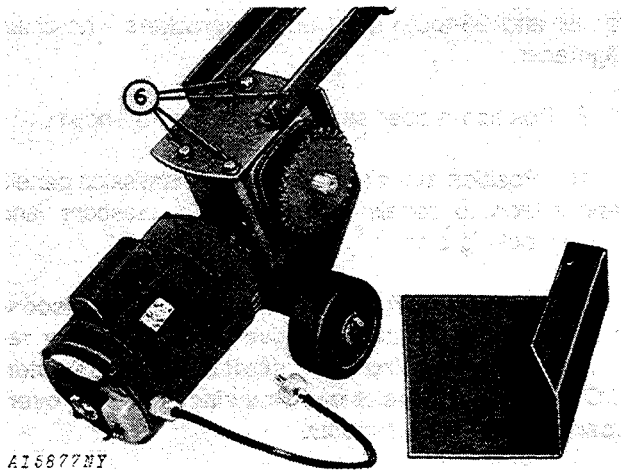

Fig. 5-Attaching Frame

6. Install run-in unit frame on gear reducer.

PLANTER RUN-IN—Continued

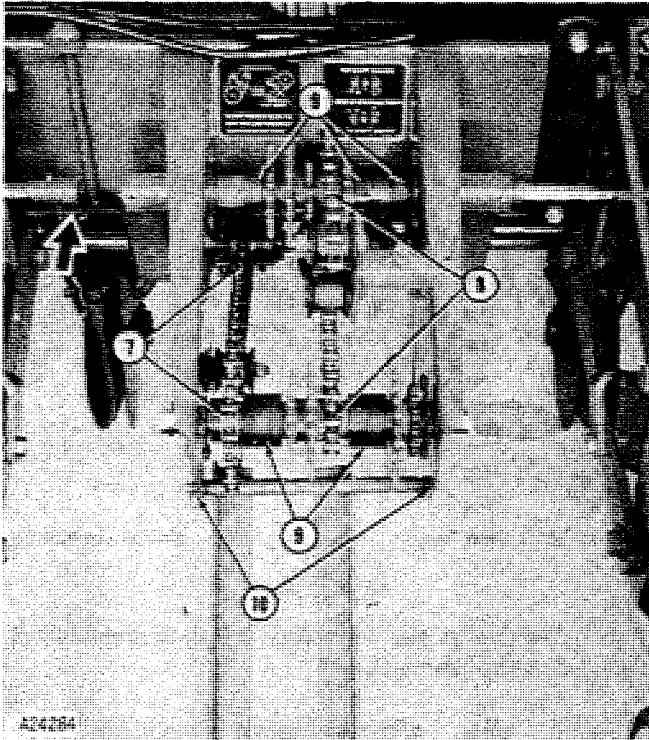

Fig. 6-Sprocket Arrangement

7. Remove the roller chain from the countershaft to lower shaft sprockets.

8. Be sure planter drive chain is on the 14-tooth steel driver and 28-tooth steel driven sprockets with chain tightener.

9. Position rubber sprocket spacers as shown.

10. Position run-in unit between transmission panels and attach to panels with drilled pin, washers, and spring locking pins.

IMPORTANT: When running-in planter, disconnect one-half the planter drive (**bold arrow**) by removing cotter pin from drill shaft and drive coupler. **DO NOT** run all rows at one time since this may overload the run-in unit motor.

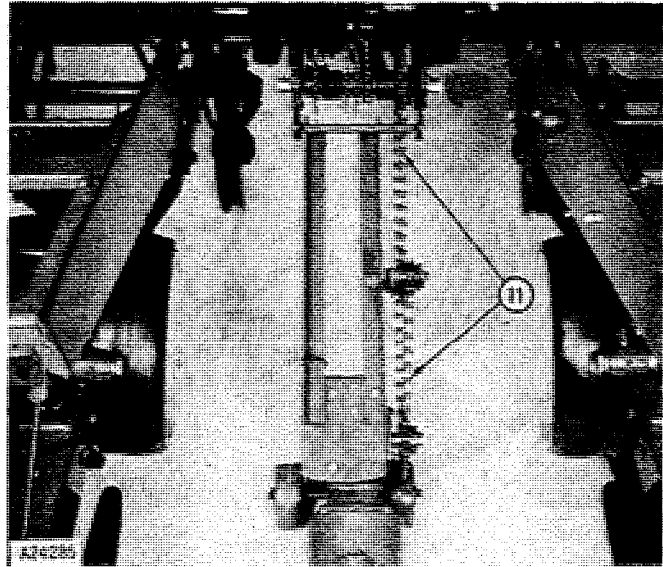

Fig. 7-Installing Chain

11. Install chain on run-in unit and 30-tooth steel sprocket. Adjust chain tightener so there is approximately 3/4-in. (19 mm) of slack in the tight side of chain and secure tightener in this position.

NOTE: Move gear reducer sprocket in or out on reducer shaft so the sprocket lines up with the transmission's lower right sprocket.

Run-In Unit Assembly—Continued

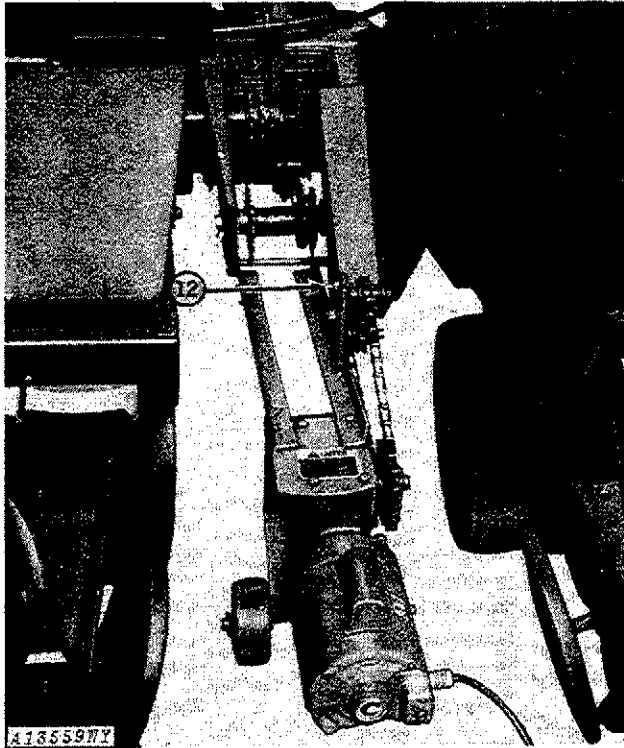

Fig. 8-Chain Shield Pivoted Back for Access to Chain and Idlers

12. Install chain shield with 3/8- x 3/4-in. cap screw and lock nut.

Tighten lock nut enough to hold shield securely in lowered or upright position, and still allow the shield to pivot.

CAUTION: Do not start motor until safety shield is in place. Keep shield in place while operating.

Do not move planter with run-in unit installed.

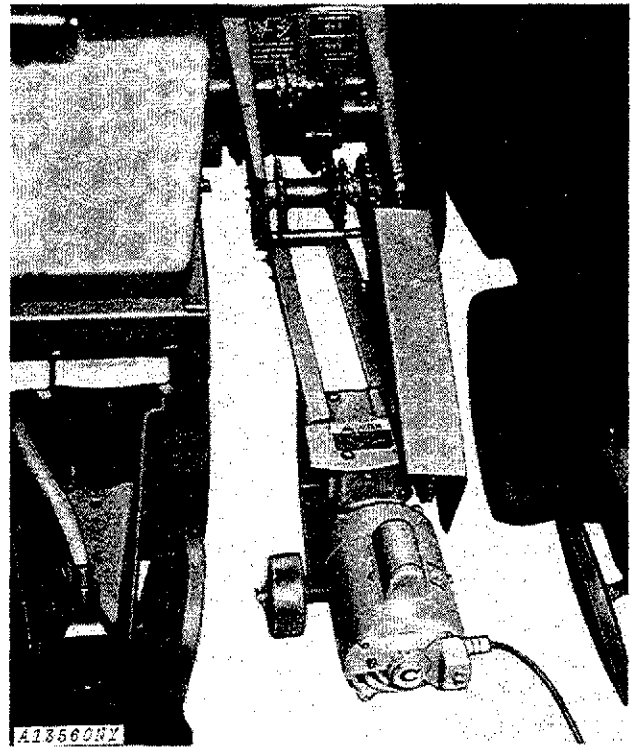

Fig. 9-Chain Shield in Operating Position

Run-In Procedure

Be certain planter is lowered to ground (planting position).

Check sprockets to be certain that they are aligned properly, and that chains are running straight.

Block planter wheels so planter will not move during run-in.

Plug run-in unit into a grounded 120 volt outlet.

Lower chain shield to operating position and turn unit on.

Watch drive chains to be certain they are running smoothly on sprockets. Listen for any unusual noises. Check all drives to be sure they are not binding.

Examine seed meter parts, checking for any excessive wear.

Group 15 LUBRICATION

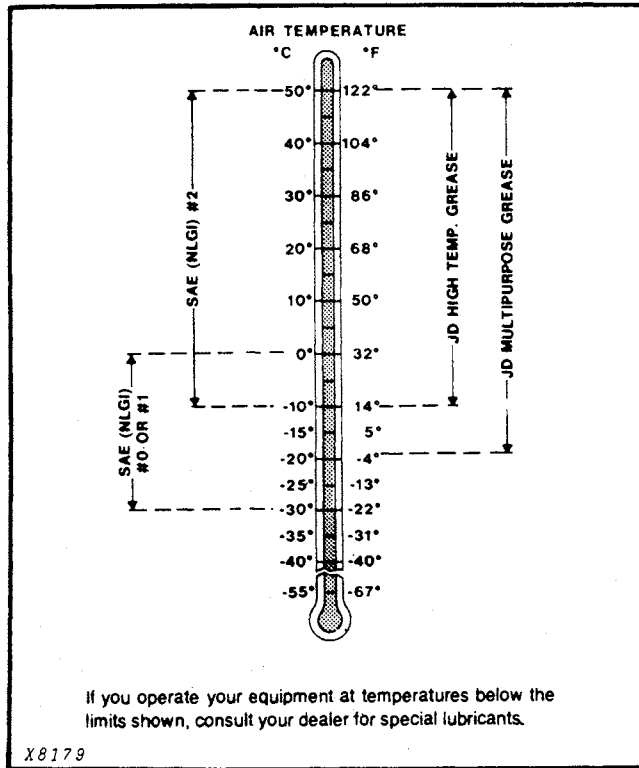

IMPORTANT: With plate-type hoppers, sprinkle a teaspoon of powdered graphite (Part No. B33379) over the top of the seed twice a day. With plateless hoppers use one teaspoon of powdered graphite each day. The graphite will filter down into the finger pickup mechanism or hopper bottom and insure proper lubrication. John Deere Graphite provides a dry lubrication. Some types have an oil base and will form a gummy residue on parts. The graphite does not eliminate the need for proper and regular lubrication indicated in the lubrication charts.

NOTE: Any additives other than John Deere powdered graphite in finger pickup units may leave residue on parts that could affect planting rates.

NOTE: Repack wheel bearings once a year with wheel bearing grease.

NOTE: All 50-hour lubrication symbols in the following illustrations mean the grease fittings should be lubricated approximately once a week.

SYMBOLS



symbols.

Lubricate with John Deere Multi-Purpose Lubricant or an equivalent SAE multi-purpose grease at hourly intervals indicated on the



Lubricate with SAE 10 oil at hourly intervals indicated on the symbols.



Brush periodically with John Deere Multi-Purpose Lubricant or an equivalent SAE multipurpose-type grease.



Lubricate all roller chains periodically with John Deere PT508 chain lube or equivalent.

**8-ROW WIDE AND
12-ROW NARROW ONLY**

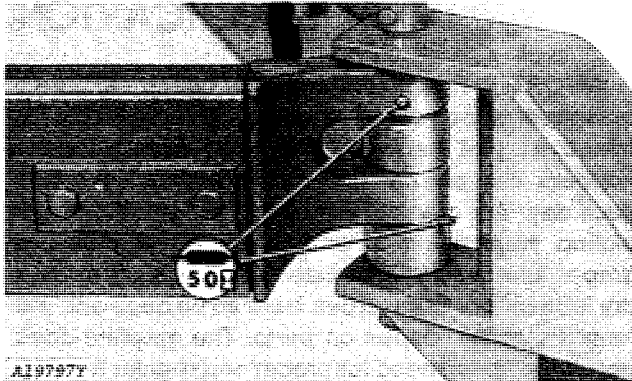

Fig. 1-Hitch

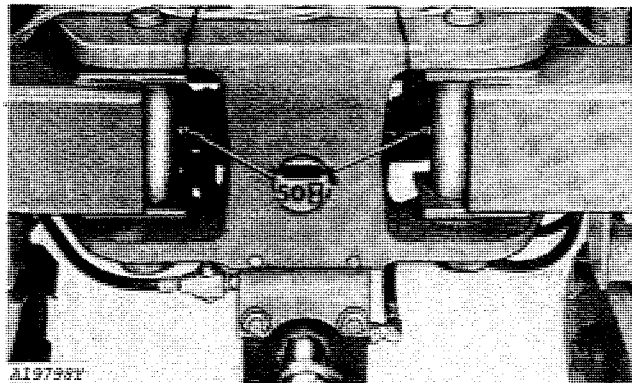

Fig. 2-Drawbar Pin

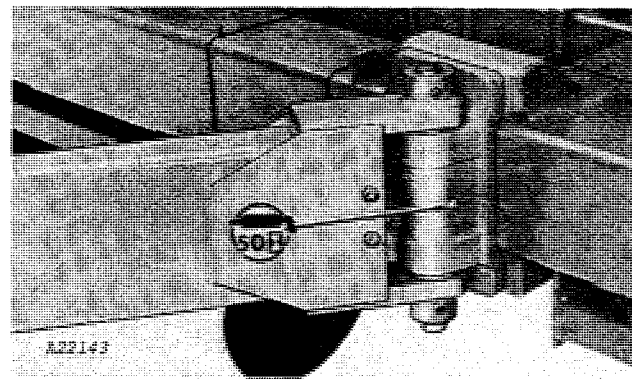

Fig. 3-Folding Drawbar Pin

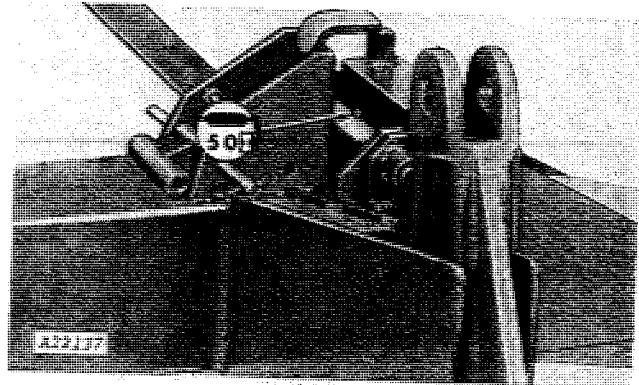

Fig. 4-Marker Hinge

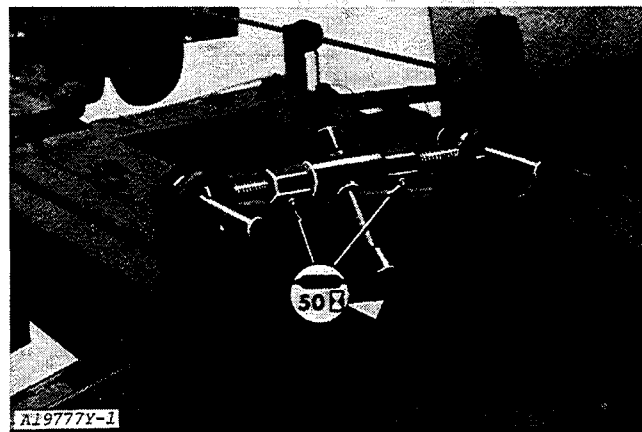

Fig. 5-Latch Turnbuckle

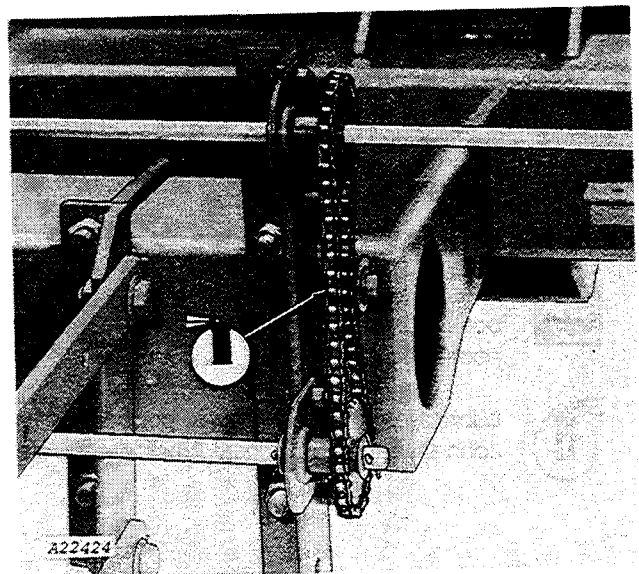

Fig. 6-Wing Planting Unit Drive

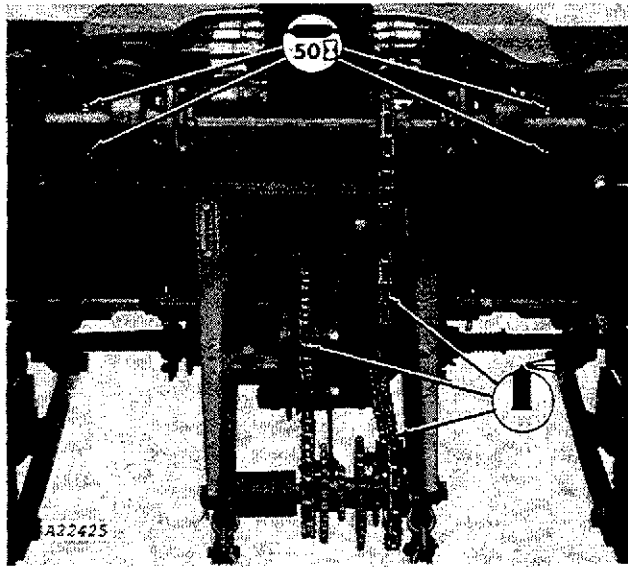

Fig. 7-Center Drive and Seed Drive Transmission

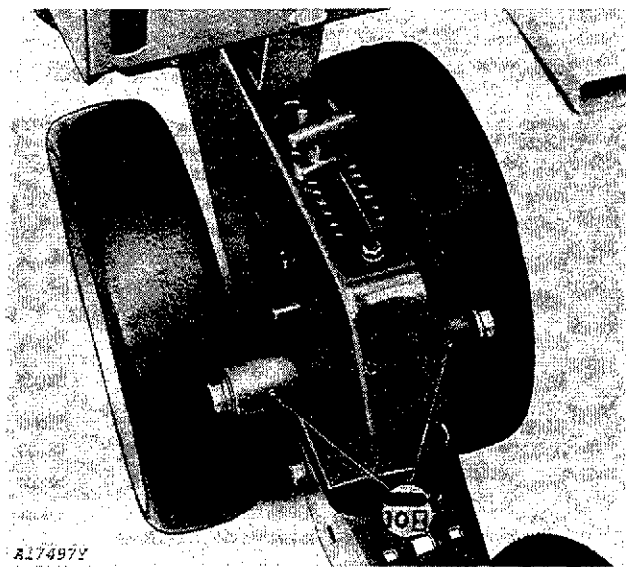

Fig. 10-Gauge Wheels

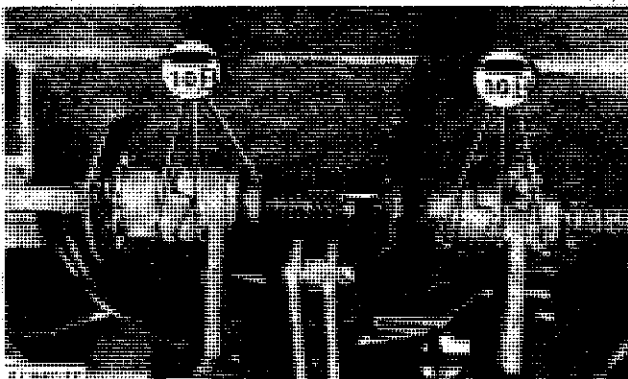
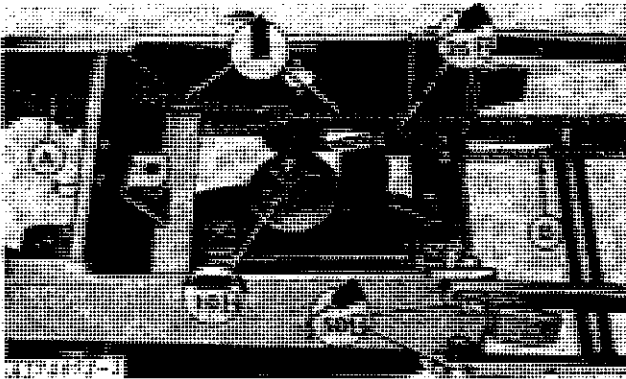

Fig. 8-Clutch Assembly



A—Insecticide and/or Herbicide Drive Chain
B—Planting Unit Drive Chain

Fig. 11-Unit Hopper Gear Drive

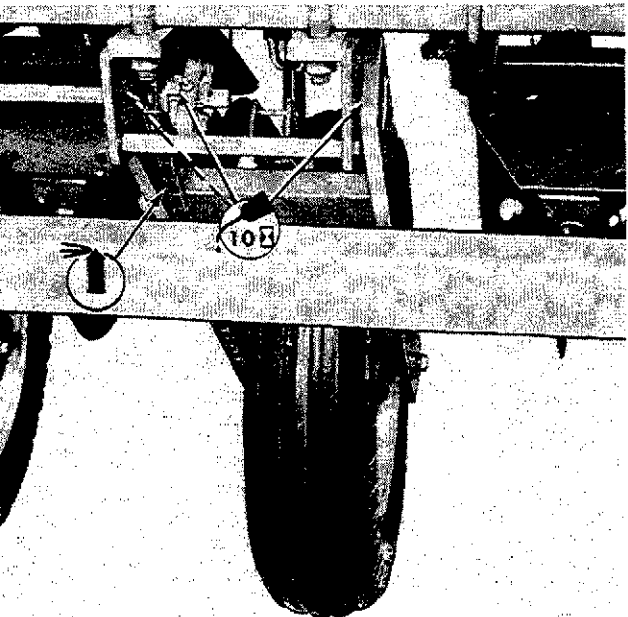

Fig. 9-Drive Wheel

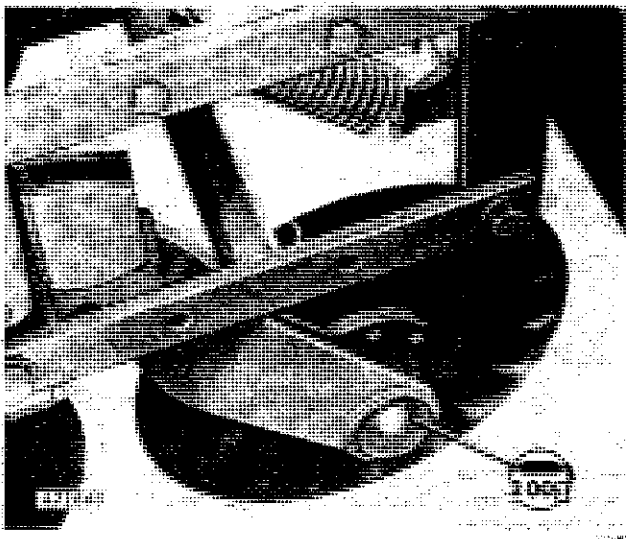

Fig. 12-Heavy-Duty Coulter

8-ROW WIDE AND 12-ROW NARROW ONLY—Continued

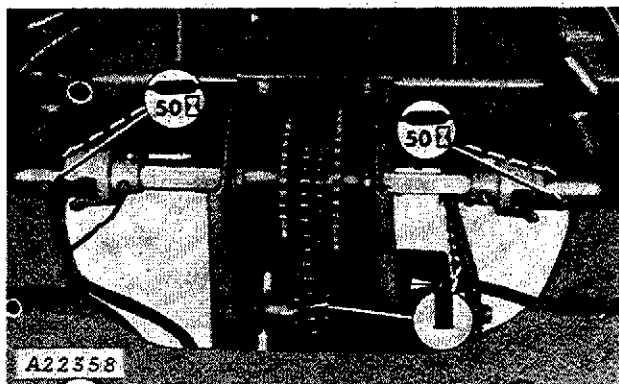

Fig. 13-Dry Fertilizer Transmission and Drive

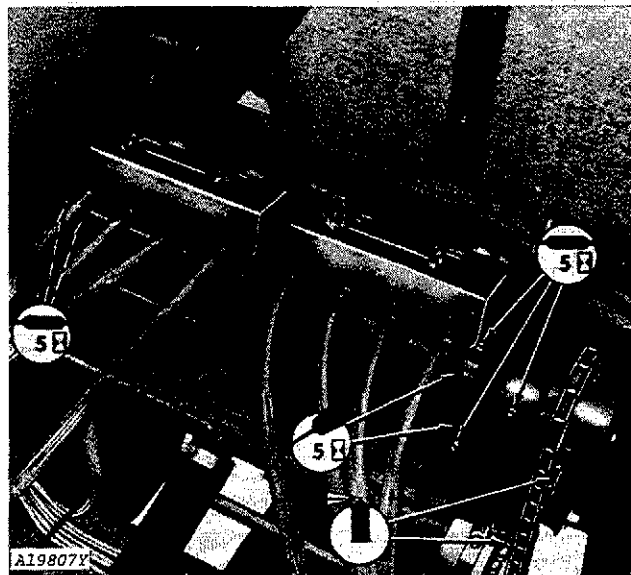

Fig. 16-Liquid Fertilizer Drive Metering Pump

Oil or repack bearing ends of squeeze roller to eliminate any remaining liquid fertilizer which would corrode the pump.

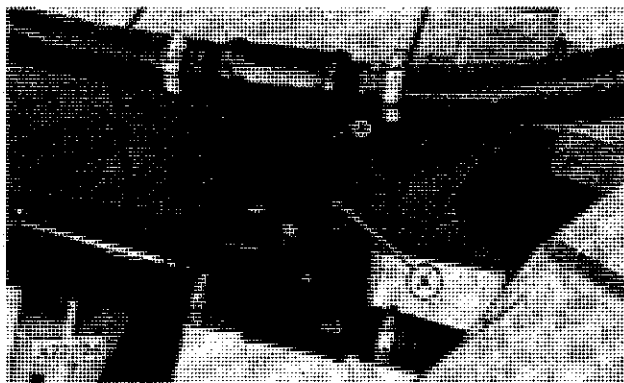

Fig. 14-Shutoff Valve (Liquid Fertilizer Attachment)

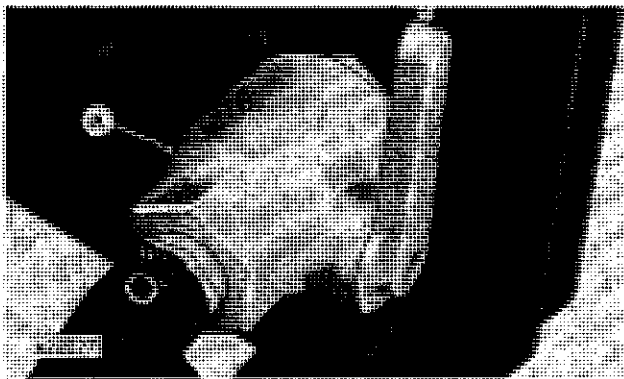

Fig. 15-Shutoff Valve (Liquid Fertilizer Attachment)

A—Lubricate at beginning and end of planting season with John Deere Multi-Purpose Lubricant or an equivalent SAE multi-purpose-type grease.

12-ROW WIDE, 16- AND 18-ROW
NARROW ONLY

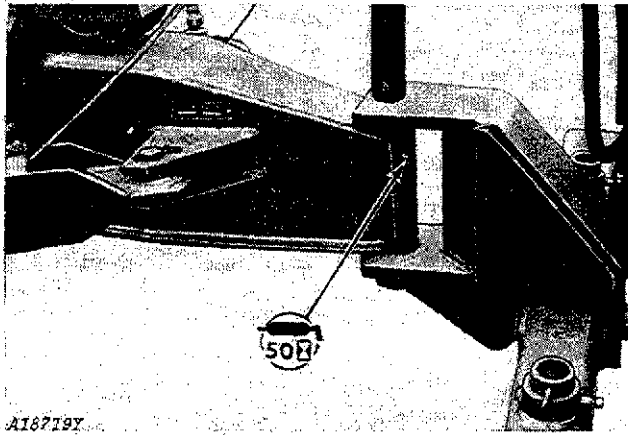

Fig. 17-Hitch

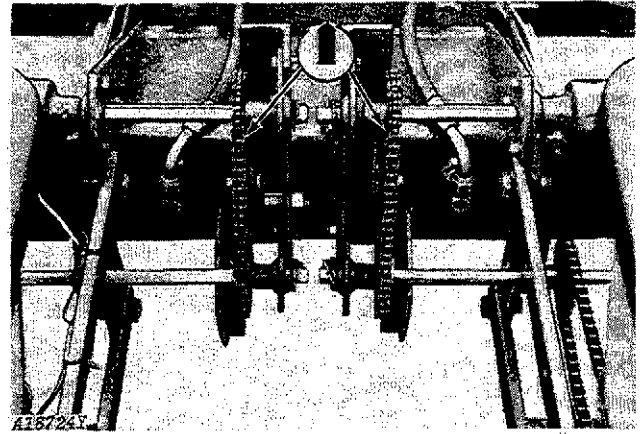

Fig. 20-Center Frame Drive

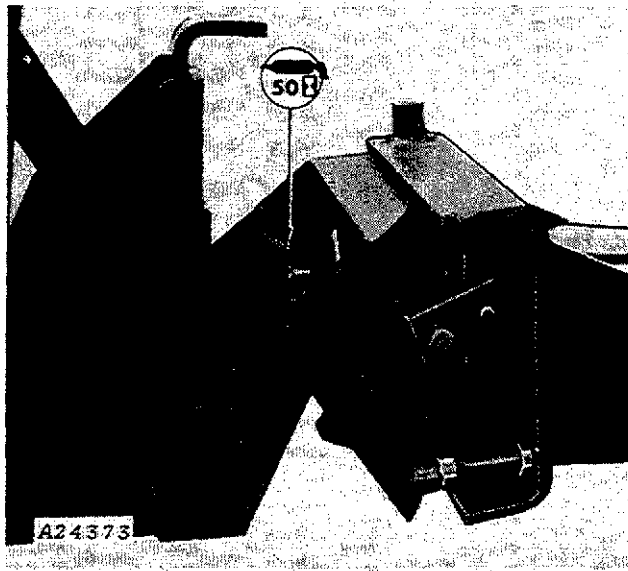

Fig. 18-Wing Marker Hinge

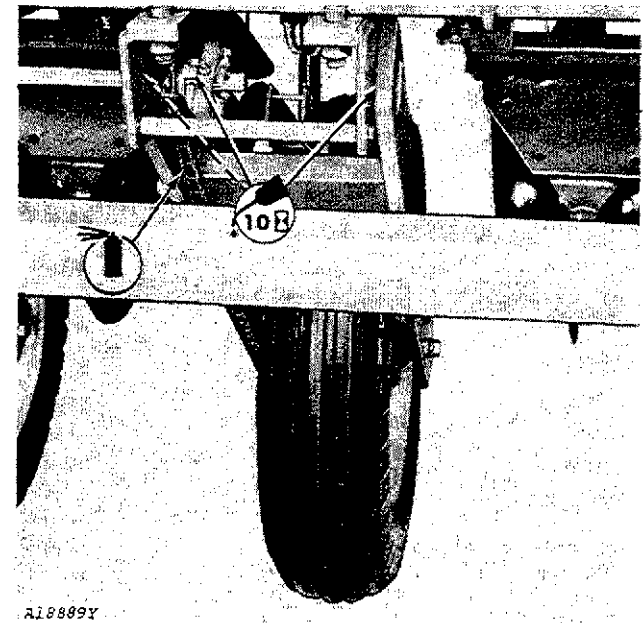

Fig. 21-Drive Wheel

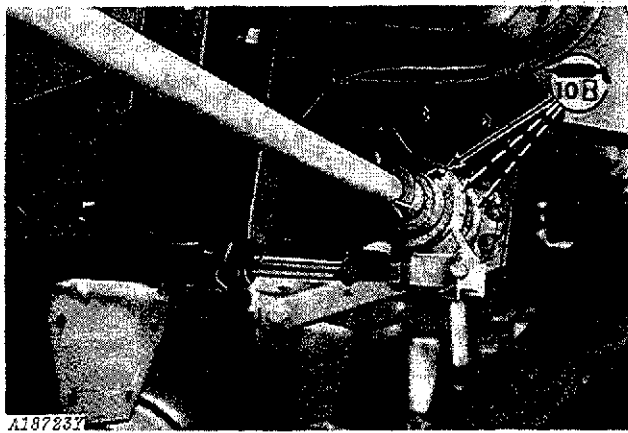

Fig. 19-Clutch Assembly

12-ROW WIDE, 16- AND 18-ROW
NARROW ONLY—Continued

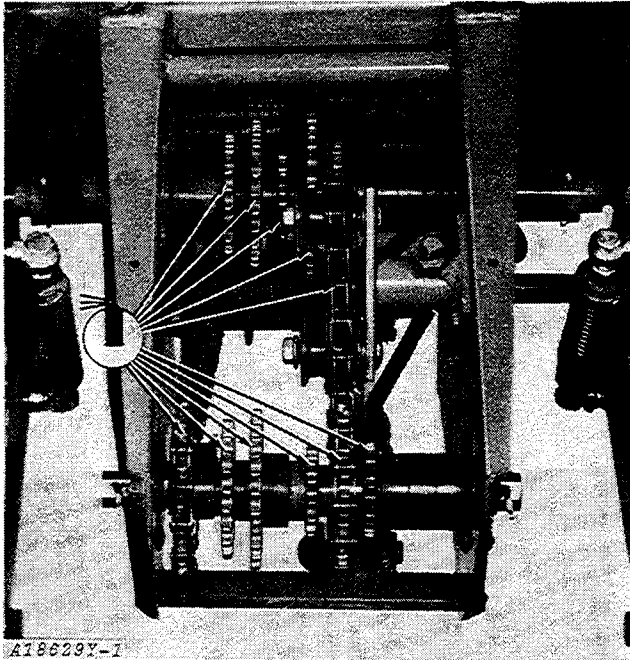

Fig. 22-Seed Drive Transmission

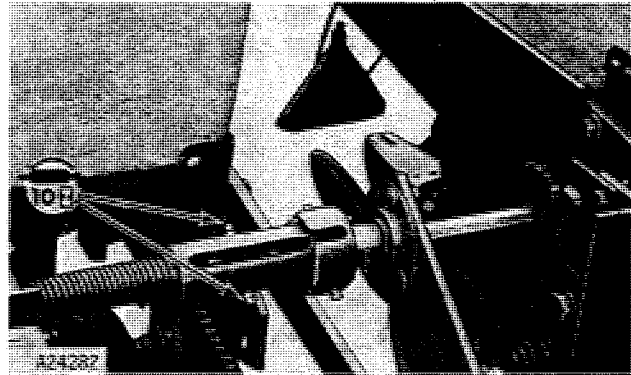

Fig. 24-Jackshaft

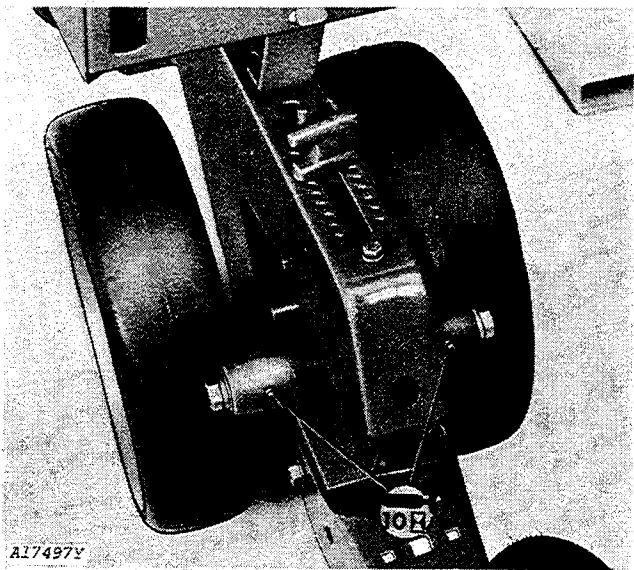

Fig. 25-Gauge Wheels

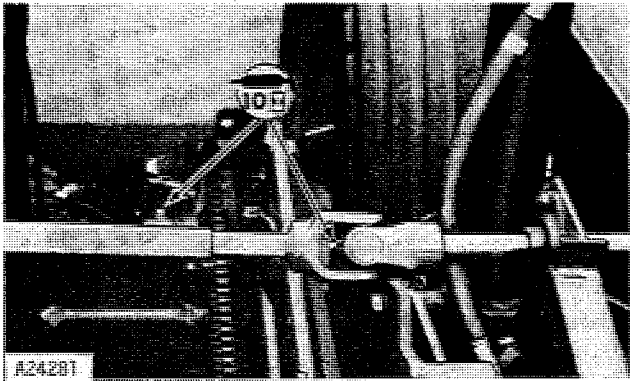
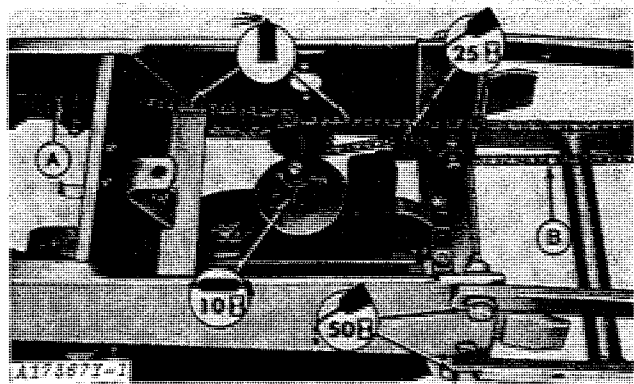

Fig. 23-Yoke and Shaft



A—Insecticide and/or
Herbicide Drive Chain B—Planting Unit Drive
Chain

Fig. 26-Unit Hopper Gear Drive

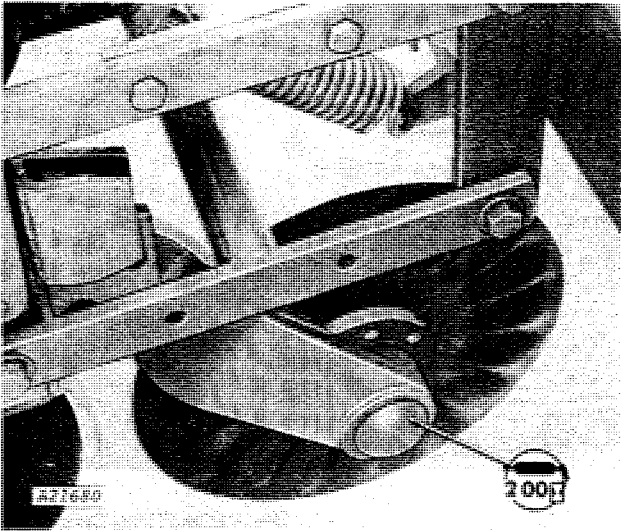

Fig. 27-Heavy Duty Coupler

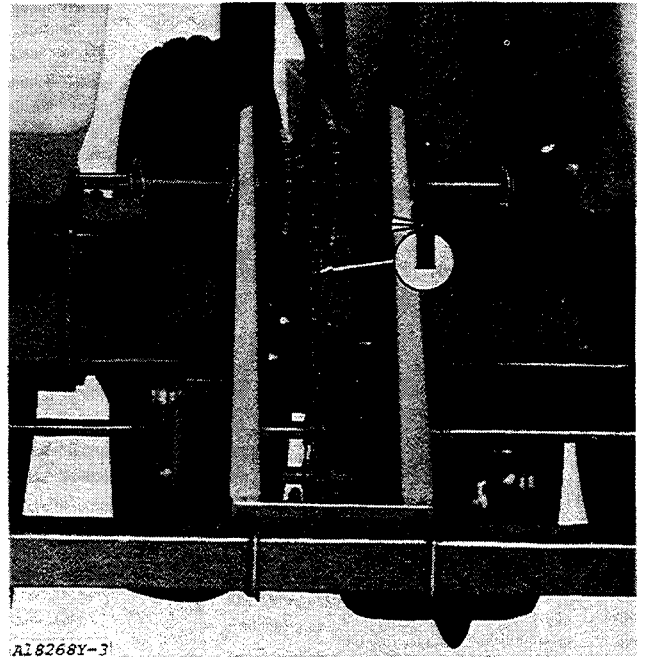

Fig. 29-Dry Fertilizer Transmission

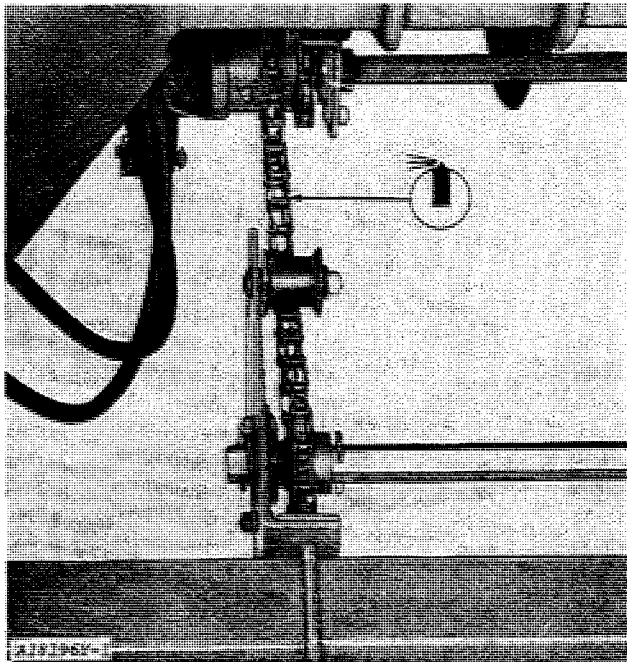
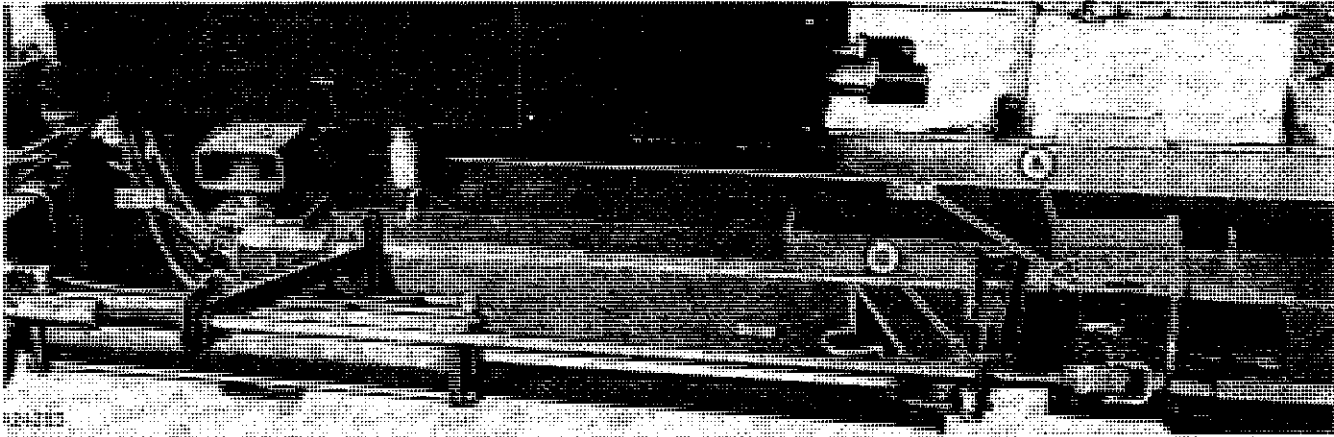

Fig. 28-Fertilizer Drive (Dry Fertilizer Shown)

12-ROW WIDE, 16- AND 18-ROW NARROW ONLY—Continued



A—Grease Fitting

B—Grease Fitting Opening

Fig. 30—Main Frame Wing

Grease fitting (A) is accessible through grease fitting opening (B).

NOTE: Lubricate at beginning and end of planting season with John Deere Multi-Purpose Lubricant or an equivalent SAE multi-purpose-type grease.

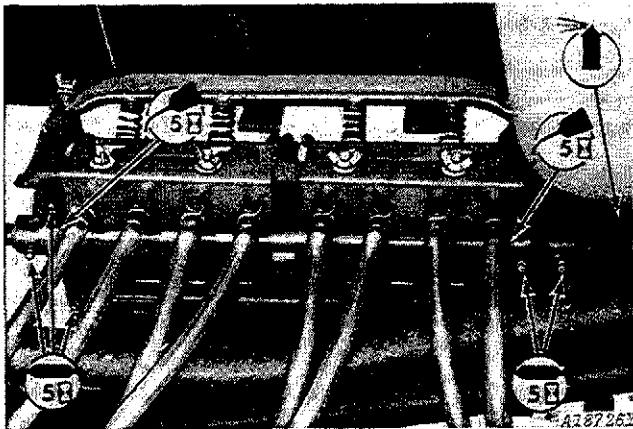

Fig. 31—Liquid Fertilizer Pump

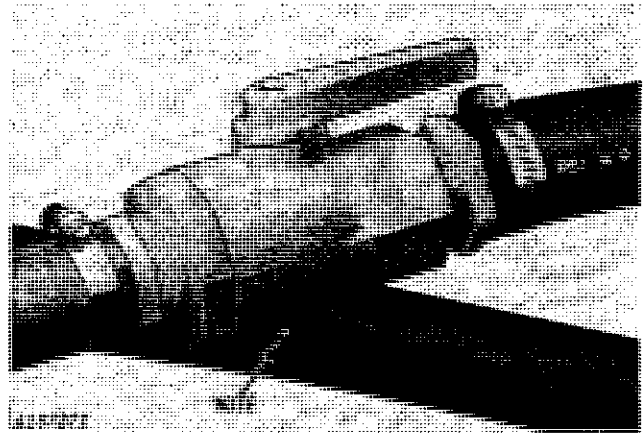

Fig. 32—Valve

24-ROW NARROW ONLY

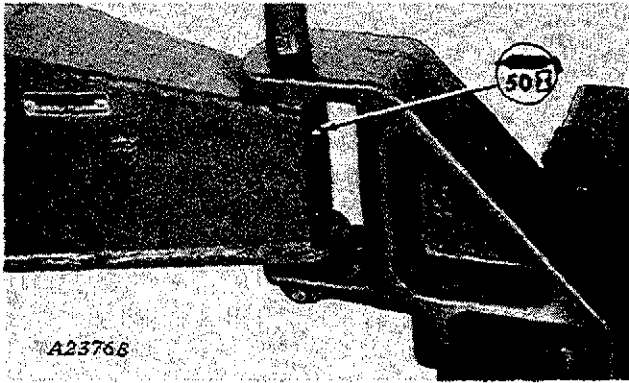

Fig. 33-Hitch

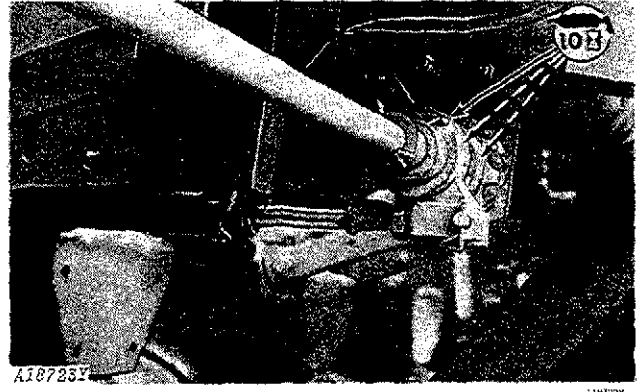

Fig. 36-Clutch

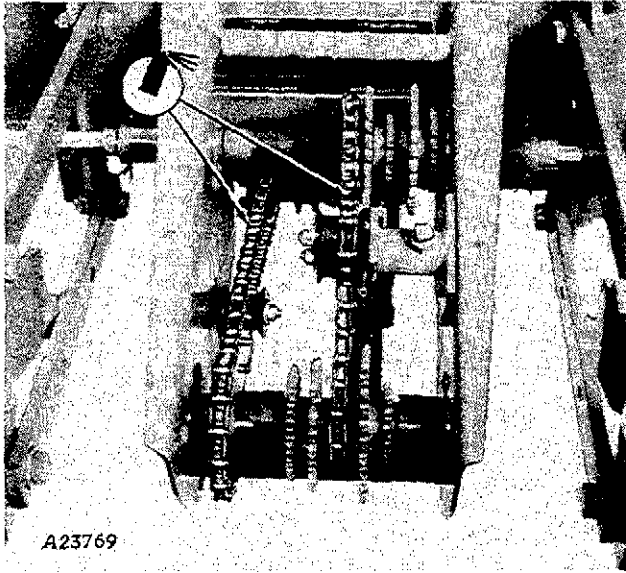

Fig. 34-Transmission

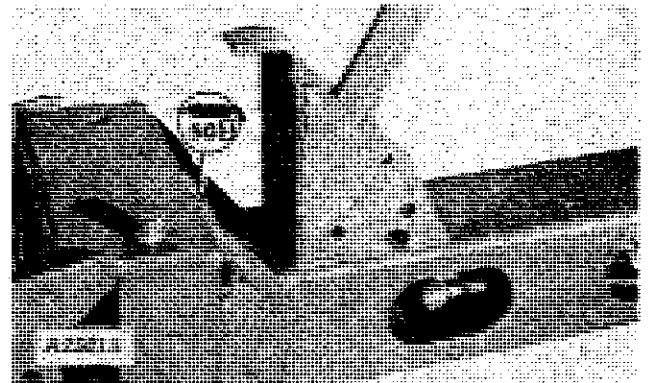

Fig. 37-Marker Wing

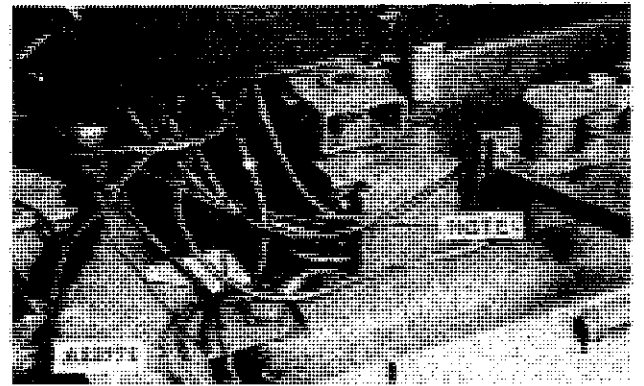

Fig. 38-Main Frame Wing



Fig. 35-Center Drive Wheel

NOTE: Lubricate at beginning and end of planting season with John Deere Multi-Purpose Lubricant or an equivalent SAE multi-purpose-type grease.

24-ROW NARROW ONLY—Continued

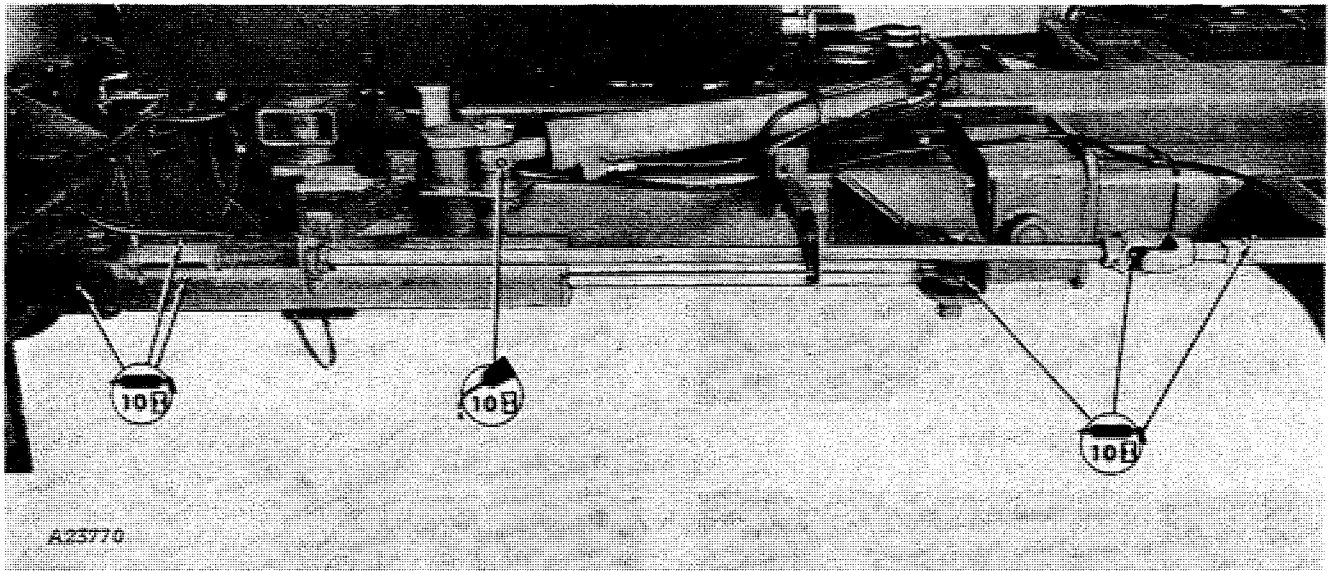

A23770

A23770

Fig. 39-Main Frame Wing

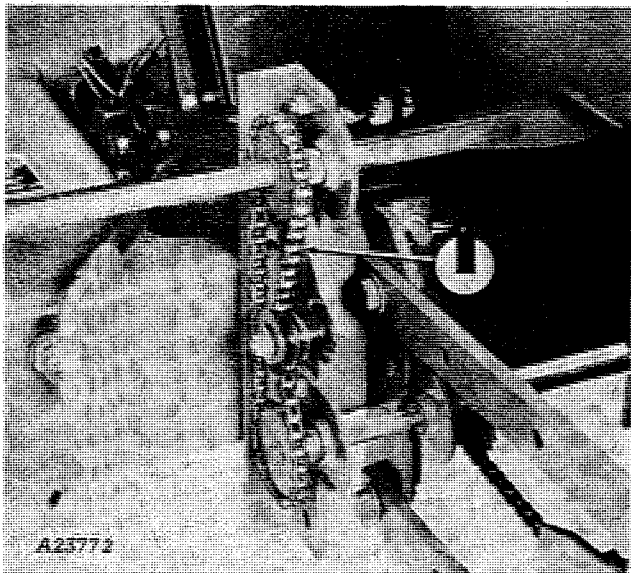

A23772

A23772

Fig. 40-Wing Planting Unit Drive



Suggest:

If the above button click is invalid.

Please download this document

first, and then click the above link

to download the complete manual.

Thank you so much for reading

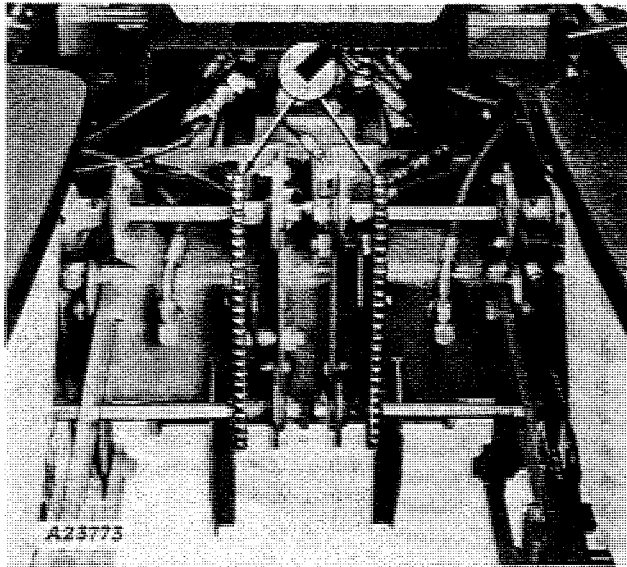

Fig. 41-Center Drive

A23773

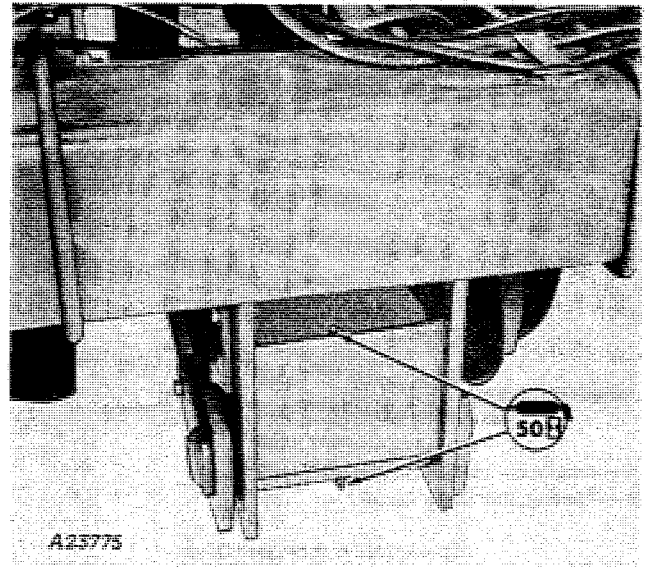

Fig. 43-Center Frame Wheel

A23775

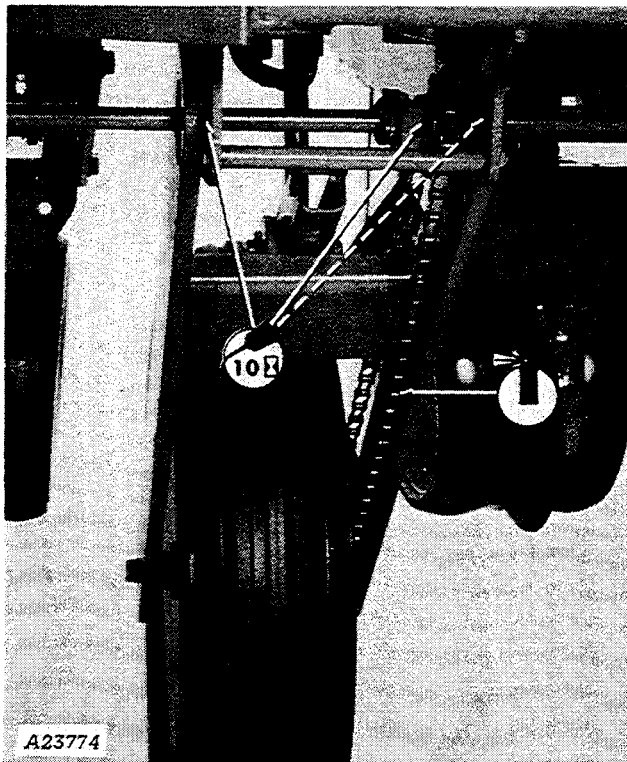

Fig. 42-Drive Wheel

A23774

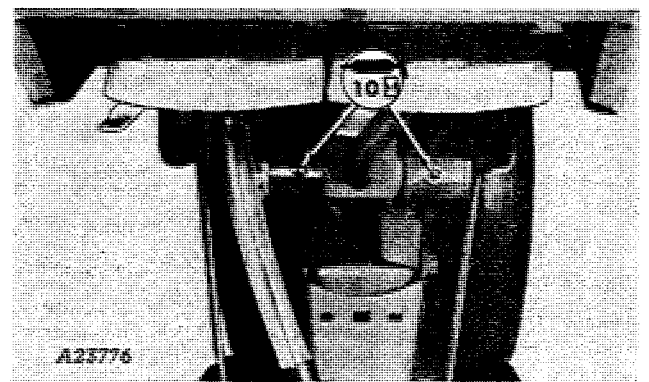

Fig. 44-Gauge Wheels

A23776

<https://www.ebooklibonline.com>

Hello dear friend!

Thank you very much for reading.

Enter the link into your browser.

The full manual is available for immediate download.

<https://www.ebooklibonline.com>