

# 6600 Side Hill 6600 and 7700 Combines



JOHN DEERE

## TECHNICAL MANUAL 6600 Side Hill 6600 and 7700 Combines

TM1021 (01JAN84) English

**John Deere Harvester Works**  
**TM1021 (01JAN84)**

LITHO IN U.S.A.  
ENGLISH



# 6600, SIDEHILL 6600, AND 7700 COMBINES

TECHNICAL MANUAL  
TM-1021 (Jan-84)

## CONTENTS

### SECTION 10 - GENERAL

- Group 5 - General Specifications
- Group 10 - Predelivery, Delivery Service, and After-Sale Inspection
- Group 15 - Lubrication
- Group 20 - Diagnosing and Testing Procedures
- Group 25 - Tune-Up and Adjustment

### SECTION 20 - ENGINES

- Group 5 - General Information, Diagnosis and Removal
- Group 10 - Cylinder Head, Valves and Camshaft
- Group 15 - Cylinder Block, Liners, Pistons and Rods
- Group 20 - Crankshaft, Main Bearings and Flywheel
- Group 25 - Lubrication System
- Group 30 - Cooling System
- Group 35 - Governor and Speed Control Linkage
- Group 40 - Specifications and Special Tools

### SECTION 30 - FUEL SYSTEM

- Group 5 - Air Intake System, Fuel Tank and Electric Fuel Pump
- Group 10 - Diesel Fuel System
- Group 15 - Gasoline Fuel System
- Group 20 - Specifications and Special Tools

### SECTION 40 - ELECTRICAL SYSTEM

- Group 5 - General Information, Wiring Diagrams and Electrical System Diagnosis
- Group 10 - Motorola Charging Circuit
- Group 15 - Delcotron Charging Circuit
- Group 20 - Delco-Remy Starting Circuit
- Group 25 - John Deere Starting Circuit
- Group 30 - Ignition Circuit
- Group 35 - Lights, Instruments and Accessory Circuits
- Group 40 - Low Shaft Speed Monitor System
- Group 45 - Harness Replacement
- Group 50 - Specifications and Special Tools

### SECTION 50 - POWER TRAIN

- Group 5 - Clutch
- Group 10 - Transmission
- Group 15 - Differential
- Group 20 - Final Drive
- Group 25 - Hydrostatic Drive
- Group 30 - Power Rear Wheel Drive
- Group 35 - Posi-Torq Ground Drive
- Group 40 - Tires and Wheels
- Group 45 - Crawler Tracks
- Group 50 - Specifications and Special Tools

### SECTION 60 - POWER STEERING AND BRAKES

- Group 5 - Power Steering
- Group 10 - Brakes
- Group 15 - Specifications

### SECTION 70 - HYDRAULIC SYSTEM

- Group 5 - Hydraulic System Operation
- Group 10 - Hydraulic System Tests
- Group 15 - Reservoir
- Group 20 - Hydraulic Pumps
- Group 25 - Hydraulic Valves
- Group 30 - Hydraulic Cylinders
- Group 35 - Hydraulic Motors
- Group 40 - Hydraulic Oil Lines and Hoses
- Group 45 - Specifications and Special Tools

### SECTION 80 - OPERATOR'S CAB

- Group 5 - Pressurizer System
- Group 10 - Air Conditioning System
- Group 15 - Heating System
- Group 20 - Personal Posture Seat
- Group 25 - Miscellaneous Components
- Group 30 - Specifications and Special Tools

## CONTENTS—Continued

### SECTION 90 - HEADERS

- Group 5 - 200 Series Cutting Platforms
- Group 10 - Quik-Tatch Cutting Platforms
- Group 15 - 40 Series Corn Heads
- Group 20 - Row-Crop Heads
- Group 25 - Specifications and Special Tools

### SECTION 100 - FEEDER HOUSE

- Group 5 - Feeder Conveyor Chain
- Group 10 - Feeder Conveyor Drum
- Group 15 - Feeder House Paddles and Stripper - SideHill 6600
- Group 20 - Variable Speed Feeder House Drives
- Group 25 - Feeder House Lower Shaft
- Group 30 - Feeder House Upper Shaft
- Group 35 - Specifications

### SECTION 110 - SEPARATOR

- Group 5 - Cylinder, Cylinder Cover, Concave and Beater
- Group 10 - Cylinder Drives
- Group 15 - Straw Walkers and Crankshafts
- Group 20 - Straw Chopper, Straw Spreader and Rear Hood
- Group 25 - Shoe Supply Augers, Cleaning Fan and Sieve Frame
- Group 30 - Tailings Elevator and Augers
- Group 35 - Clean Grain Elevator, Lower Auger and Grain Tank Loading Auger
- Group 40 - Separator Uprights
- Group 45 - Specifications and Special Tools

### SECTION 120 - GRAIN TANK AND UNLOADING AUGERS

- Group 5 - Grain Tank Auxiliary Unloading Augers and Drive
- Group 10 - Grain Tank Inner and Outer Unloading Augers
- Group 15 - Grain Tank
- Group 20 - Specifications

### SECTION 130 - MAJOR DRIVES

- Group 5 - Engine Powershaft
- Group 10 - Primary Countershaft
- Group 15 - Secondary Countershaft
- Group 20 - Separator Control Lever
- Group 25 - Specifications

### SECTION 140 - ELECTRO-HYDRAULIC SYSTEMS

- Group 5 - General Information, Diagnosis and Tests - SideHill 6600 Leveling System
- Group 10 - Electrical Components - SideHill 6600 Leveling System
- Group 15 - Hydraulic Components - SideHill 6600 Leveling System
- Group 20 - General Information, Diagnosis and Tests - Automatic Header Height Control
- Group 25 - Mechanical System - Automatic Header Height Control
- Group 30 - Electrical System - Automatic Header Height Control
- Group 35 - Hydraulic System - Automatic Header Height Control
- Group 40 - Unloading Auger Hydraulic Swing and Automatic Latching System
- Group 45 - Specifications and Special Tools

### SECTION 150 - MACHINE RECONDITIONING

- Group 5 - Cleaning and Painting
- Group 10 - Decal Installation
- Group 15 - Shielding
- Group 20 - Specifications

*All information, illustrations and specifications contained in this technical manual are based on the latest information available at the time of publication. The right is reserved to make changes at any time without notice.*

*The specifications given in this technical manual are intended for service only. They do not include normal factory manufacturing tolerances.*

Copyright© 1984 Deere & Company  
Moline, Illinois All rights reserved.  
Previous Editions

Copyright© 1981 Deere & Company  
Copyright© 1979 Deere & Company  
Copyright© 1978 Deere & Company  
Copyright© 1977 Deere & Company  
Copyright© 1976 Deere & Company  
Copyright© 1975 Deere & Company  
Copyright© 1974 Deere & Company  
Copyright© 1973 Deere & Company

**<https://www.ebooklibonline.com>**

Hello dear friend!

Thank you very much for reading.

Enter the link into your browser.

The full manual is available for immediate download.

**<https://www.ebooklibonline.com>**

## SAFETY AND YOU

### AVOID FIRE HAZARDS



T27999N

### INTRODUCTION

 This safety alert symbol identifies important safety messages in this manual and on the combine. When you see this symbol, be alert to the possibility of personal injury and carefully read the message that follows.

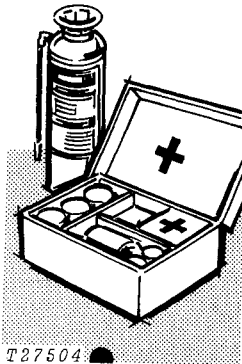

T27504

Be prepared if an accident or fire should occur. Know where the first aid kit and the fire extinguishers are located—know how to use them.

### SERVICE AREA

Keep the service area clean and dry. Wet or oily floors are slippery. Wet spots can be dangerous when working with electrical equipment.

Make sure the service area is adequately vented.

Periodically check the shop exhaust system for leakage. Engine exhaust gas is dangerous.

Be sure all electrical outlets and tools are properly grounded.

Use adequate light for the job at hand.



H24228N

WRONG

Don't smoke while refueling or handling highly flammable material.

Engine should be shut off when refueling.

Use care in refueling if the engine is hot.

Don't use open pans of gasoline or diesel fuel for cleaning parts. Good commercial, nonflammable solvents are preferred.

Provide adequate ventilation when charging batteries.

Don't check battery charge by placing metal objects across the posts.

Don't allow sparks or open flame near batteries.

Don't smoke near battery.

Never check fuel, battery electrolyte or coolant levels with an open flame.

Never use an open flame to look for leaks anywhere on the equipment.

Never use a open flame as a light anywhere on or around the equipment.

When preparing engine for storage, remember that inhibitor is volatile and therefore dangerous. Seal and tape openings after adding the inhibitor. Keep container tightly closed when not in use.

## CLEANING THE COMBINE

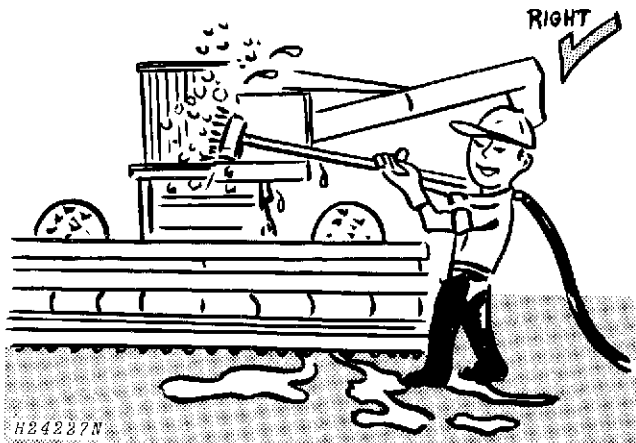

Always stop the engine before cleaning the combine.

Keep the operator's platform clean. Do not use it as a storage area.

Keep the radiator and engine closure screens free of foreign matter. Avoid a possible fire hazard.

Keep all equipment free of dirt and oil. In freezing weather, beware of snow and ice on ladder steps and operator's platform.

## FLUIDS UNDER PRESSURE

Escaping fluid under pressure can have sufficient force to penetrate the skin, causing serious personal injury. Before disconnecting lines, be sure to relieve all pressure. Before applying pressure to the system, be sure all connections are tight and that lines, pipes and hoses are not damaged. Fluid escaping from a very small hole can be almost invisible. Use a piece of cardboard or wood, rather than hands, to search for suspected leaks.

If injured by escaping fluid, see a doctor at once. Serious infection or reaction can develop if proper medical treatment is not administered immediately.

Don't forget the hydraulic system or diesel fuel injection system may be pressurized! To relieve pressure, follow the technical manual.

When checking hydraulic pressure, be sure to use the correct test gauge for the pressure in the particular system.

## PERSONAL SAFETY

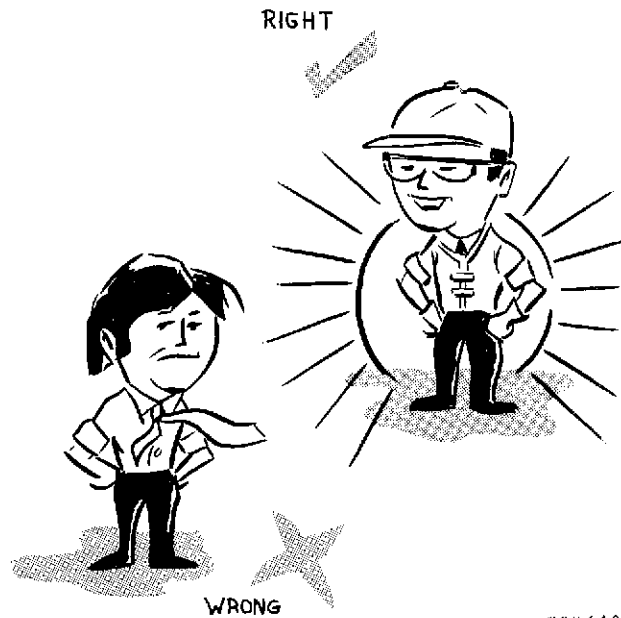

Always avoid loose clothing or any accessory—flopping cuffs, dangling neckties and scarves—that can catch in moving parts and put you out of work. Always wear your safety glasses while on the job.

Keep transmission and brake control units properly adjusted at all times. Before making adjustments, stop engine.

Before removing any housing covers, stop engine. Take all objects from your pockets which could fall into the opened housings. Don't let adjusting wrenches fall into opened housings.

Don't attempt to check belt tension while the engine is running.

Don't adjust the fuel system while the machine is in motion.

Before repairing the electrical system, or performing a major overhaul, make sure the batteries are disconnected.

Avoid working on equipment with the engine running. If it is necessary to make checks with the engine running, ALWAYS USE TWO TECHNICIANS—one, the operator, at the controls, the other checking where the operator can see him. Also, put the transmission in neutral, set the brake, and apply any safety locks provided. KEEP HANDS AWAY FROM MOVING PARTS.

Use extreme caution in removing radiator caps, drain plugs, grease fittings, or hydraulic pressure caps.

# Section 10 GENERAL

## CONTENTS OF THIS SECTION

GROUP 5 - GENERAL SPECIFICATIONS	Page	Page	
Description .....	5-1	Engine Operating Procedure .....	10-16
Serial Numbers .....	5-1	Combine Run-In .....	10-17
Engines .....	5-2	Temporary Storage .....	10-17
Electrical System .....	5-2	200 Series Cutting Platforms Predelivery ..	10-20
Clutch .....	5-2	40 Series Corn Heads Predelivery .....	10-32
Transmission .....	5-2	50 Series Row-Crop Heads Predelivery ...	10-38
Final Drive .....	5-2	Installation of Automatic Header Height	
Steering .....	5-2	Control on 200 Series Platforms .....	10-41
Brakes .....	5-2	Installation of Automatic Header Height	
Hydraulic System .....	5-3	Control on Row-Crop Heads .....	10-42
Capacities .....	5-3	Delivery Service .....	10-51
Dimensions .....	5-3	After-Sale Inspection .....	10-51
Ground Speeds .....	5-4	GROUP 15 - LUBRICATION	
GROUP 10 - PREDELIVERY, DELIVERY		GROUP 20 - DIAGNOSING AND TESTING	
SERVICE, AND AFTER-SALE		PROCEDURES	
INSPECTION		GROUP 25 - TUNE-UP AND ADJUSTMENT	
Combine Predelivery		General Information .....	25-1
Controls and Instruments .....	10-1	Preliminary Engine Testing .....	25-1
Prestarting Checks (Before Unloading		Engine Tune-Up .....	25-2
Combine) .....	10-3	Final Engine Testing .....	25-4
Unloading Combine from		Miscellaneous Adjustments .....	25-4
Freight Car or Truck .....	10-5	Standard Torque Chart .....	25-5
Assembly .....	10-6	Care and Maintenance of	
Checks and Adjustments .....	10-12	Belts and Chains .....	25-6

## Group 5 GENERAL SPECIFICATIONS

### DESCRIPTION

The 6600 Self-Propelled Combine has a 44-inch (1118 mm) wide separator. It is powered by either a 303 or 329 gasoline engine or a 329 or 404 diesel engine. It is equipped with hydraulic shoe-type brakes and a 4-speed, collar shaft, constant-mesh transmission.

The SideHill 6600 Self-Propelled Combine has a 44-inch (1118 mm) wide separator. It is powered by a 404 diesel or turbocharged diesel engine. It is equipped with hydraulic shoe-type brakes and a 4-speed, collar-shaft, constant-mesh transmission.

The 7700 Self-Propelled Combine has a 55-inch (1397 mm) wide separator. It is powered by either a 362 gasoline engine or a 404 diesel or turbocharged diesel engine. It is equipped with hydraulic shoe-type brakes and a 4-speed, collar-shaft, constant-mesh transmission.

"Right-hand" and "left-hand" sides are determined by facing in the direction the combine will travel when in use.

### SERIAL NUMBERS

Serial Number Unit	Location
Combine .....	Rear left-hand upright
Engine .....	Right-hand side of cylinder block
Hydrostatic Unit .....	Under pump section
Feeder House	
(early combines) .....	Right-hand side sheet
Cutting Platform and	
Pickup Platform .....	Left-hand side of main frame
Corn Head .....	Lower right-hand side on bulk-head frame
Row-Crop Head .....	Left-hand side end sheet of main frame

## SPECIFICATIONS

ENGINES:	Gasoline	Diesel
6600	(HD-303-G) ( -3727)	(HC-329-D) ( -3700)
	(HF-329-G) (3728-7500)	(329DH-01) ( 3701-254050)
	(329GH-01) (3728-7500)	(404DH-05) (254051- )
	(329GH-02) (7501-156500)	
SideHill 6600		(404DH-05) ( -254050)
		(404DH-06) (254051-304000)
		(404TH-02) (304001- )
7700	(362GHA) ( -2800)	(404DHA) ( -2800)
	(362GH-01) (2801-111900)	(404DH-01) ( 2801-8000)
		(404DH-04) ( 8001- )
		(404TH-01) ( 8001- )
Type	4-stroke cycle, 6-cylinder-in-line, valve-in-head	

Cubic inch displacement and brake horsepower		
Gasoline	303 (4965 cm <sup>3</sup> )	104 (78 kW)
	329 (5391 cm <sup>3</sup> )	110 (82 kW)
	362 (5932 cm <sup>3</sup> )	128 (95 kW)
Diesel	329 (5391 cm <sup>3</sup> )	104 (78 kW)
	6600 and SideHill 6600	120 (90 kW)
	7700	128 (95 kW)
	404 (Turbo) (6620 cm <sup>3</sup> )	
	SideHill 6600	
	(304001- )	135 (101 kW)
	404 (Turbo) (6620 cm <sup>3</sup> )	145 (108 kW)

Bore and stroke, inches (mm)		
	Bore	Stroke
303	3.86 ( 98.04 mm)	4.33 (109.98 mm)
329	4.02 (102.11 mm)	4.33 (109.98 mm)
362	4.25 (107.95 mm)	4.25 (107.95 mm)
404	4.25 (107.95 mm)	4.75 (120.65 mm)

Compression ratio	
Gasoline	7.5 to 1
Diesel (Clean Engine)	16.7 to 1
	14.7 to 1 (Turbo)

Valve Clearance			
Gasoline (hot or cold) intake		Exhaust	
303	0.014 in. (0.356 mm)	0.022 in. (0.559 mm)	
329	0.014 in. (0.356 mm)	0.022 in. (0.559 mm)	
362	0.015 in. (0.381 mm)	0.028 in. (0.711 mm)	
Diesel (hot or cold)			
329	0.014 in. (0.356 mm)	0.018 in. (0.457 mm)	
404	0.018 in. (0.457 mm)	0.028 in. (0.711 mm)	
(Turbocharged)			
404	0.018 in. (0.457 mm)	0.028 in. (0.711 mm)	
Engine speeds: (Normal slow idle)			
		(Fast idle with separator engaged)	
Gasoline	303	800 rpm	2650 rpm
	329	800 rpm	2650 rpm
	362	800 rpm	2650 rpm
Diesel	329	1200 rpm	2650 rpm
	404	1200 rpm	2650 rpm
(Turbocharged)	404	1200 rpm	2350 rpm

Injection pump timing	TDC
Distributor timing:	
303	2650 rpm 24° Mark
329	2650 rpm 24° Mark
362	2000 rpm 20° Mark

Distributor point gap	
303	0.020 in. (0.508 mm)
329	0.020 in. (0.508 mm)
362	0.016 in. (0.406 mm)

Distributor cam dwell:	
303	66° to 72°
329	36° to 42°
362	31° to 34°

Spark plug gap	0.025 in. (0.635 mm)
----------------	----------------------

**ELECTRICAL SYSTEM:**

Battery voltage	12 volts
Battery specific gravity at full charge (corrected to 80°F [27°C])	1.260 (±0.010)
Battery terminal grounded	negative
Alternator regulation	Voltage regulator

**CLUTCH:**

Type: 12-inch (305 mm) dry disk-type clutch hydraulically actuated by foot pedal.

**TRANSMISSION:**

Type: Automotive spur gear with four forward speeds and one reverse speed. Transmission is equipped with safety start switch. Available as Belt Drive, Posi-Torq or Hydrostatic Drive.

**FINAL DRIVE:**

Type: Pinion and ring gear

Ratios:	
6600	Regular 13 to 89
	Heavy-Duty 11 to 90
	Extra Heavy-Duty 11 to 104
SideHill 6600	11 to 90
7700	Heavy-Duty 11 to 90
	Extra Heavy-Duty 11 to 104

Powered rear wheel drive gear train (6600 and 7700 Combines) (double planetary reduction):

25.1 reduction ratio (combines equipped with tires)
40.6 reduction ratio (combines equipped with crawler tracks)

**STEERING:**

Type: Full power hydrostatic steering.

**BRAKES:**

Type: 12-inch (305 mm) hydraulically actuated shoe-type. Individual brakes controlled by separate pedals.

**HYDRAULIC SYSTEM:**

Type: Open-center, constant-flow system. Includes power steering, header lift, automatic header height control, reel drive, reel lift, selective ground speed, variable speed feeder house, unloading auger swing, and SideHill 6600 leveling system.

Pump ..... Cessna gear-type

Relief Pressures .....(± 100 psi [6.8 bar])	
6600 ( -156500).....	2000 psi (136 bar)
6600 (156501- ).....	2250 psi (153 bar)
SideHill 6600 .....	2250 psi (153 bar)
7700 ( -163900).....	2000 psi (136 bar)
7700 (163901- ).....	2250 psi (153 bar)

**Flow rates (at 2500 to 2625 rpm):**

**Main System**

6600 ( -156500).....	7.15 gpm (45 m <sup>3</sup> s)
6600 (156501-206200).....	6.95 gpm (44 m <sup>3</sup> s)
6600 (206201- ).....	7.15 gpm (45 m <sup>3</sup> s)
SideHill 6600 (156501-208362) .....	7.15 gpm (45 m <sup>3</sup> s)
SideHill 6600 (208363- ) .....	10.40 gpm (65 m <sup>3</sup> s)
7700 .....	10.40 gpm (65 m <sup>3</sup> s)
7700 (Turbocharged) .....	9.20 gpm (58 m <sup>3</sup> s)

**Steering System**

6600 ( -156500).....	3.00 gpm (19 m <sup>3</sup> s)
6600 (156501-206200).....	3.20 gpm (21 m <sup>3</sup> s)
6600 (206201- ).....	3.15 gpm (20 m <sup>3</sup> s)
SideHill 6600 (156501-208362) .....	3.15 gpm (20 m <sup>3</sup> s)
SideHill 6600 (208363- ) .....	5.00 gpm (32 m <sup>3</sup> s)
7700 ( -8000 ).....	3.15 gpm (20 m <sup>3</sup> s)
7700 (With Power Rear Wheel Drive)	
( -8000 ) .....	5.00 gpm (32 m <sup>3</sup> s)
7700 ( 8001- ).....	5.00 gpm (32 m <sup>3</sup> s)
7700 Turbocharged .....	4.40 gpm (28 m <sup>3</sup> s)

**CAPACITIES:**

Cooling System: (Add 1-1/2-qts (1.4 l) for heater

Gasoline .. 303 .....	28 U.S. Qts. (27 l)
329 .....	28 U.S. Qts. (27 l)
362 .....	32 U.S. Qts. (30 l)
Diesel..... 329 .....	28 U.S. Qts. (27 l)
404 .....	32 U.S. Qts. (30 l)
404 (Turbocharged) .....	32 U.S. Qts. (30 l)

**Engine Crankcase:**

Gasoline .. 303 .....	10 U.S. Qts. (9.5 l)
329 .....	10 U.S. Qts. (9.5 l)
362 (7700) ( -2800) ..	12 U.S. Qts. (11 l)
362 (7700) (2801-111900) ..	15 U.S. Qts. (14 l)
Diesel..... 329 .....	10 U.S. Qts. (9.5 l)
404 (6600 and SideHill ..	17 U.S. Qts. (16 l)
6600)	
404 (7700) ( -2800) ..	12 U.S. Qts. (11 l)
404 (7700) (2801-8000) ..	15 U.S. Qts. (14 l)
404 (7700) (8001- ) ..	17 U.S. Qts. (16 l)
404 (Turbocharged) .....	17 U.S. Qts. (16 l)

**Fuel Tank:**

6600 .....	57 U.S. Gals. (216 l)
SideHill 6600 ( -211800) .....	57 U.S. Gals. (216 l)
SideHill 6600 (254051- ) .....	72 U.S. Gals. (273 l)
7700 .....	72 U.S. Gals. (273 l)
Transmission .....	11 U.S. Qts. (10.5 l)

**Final Drives:**

6600 .....	Regular-duty .....	10 U.S. Pts. each (4.7 l)
	Heavy-duty .....	10 U.S. Pts. each (4.7 l)
	Extra-heavy-duty .....	11 U.S. Pts. each (5.2 l)
SideHill 6600 .....		12 U.S. Pts. each (5.6 l)
7700 .....	Heavy-duty .....	10 U.S. Pts. each (4.7 l)
	Extra-heavy-duty .....	11 U.S. Pts. each (5.2 l)

**Hydraulic System (including lines and components):**

6600 and 7700 .....	17-1/2 U.S. Qts. (16.5 l)
SideHill 6600 .....	24-1/2 U.S. Qts. (23 l)

Hydraulic Brake Master Cylinder..... 1 U.S. Pt. (0.47 l)

Hydraulic Clutch Master Cylinder .....

1/2 U.S. Pt. (0.24 l)

**Hydrostatic Drive System**

(including lines and components)..... 30 U.S. Qts. (28 l)

**DIMENSIONS:**

6600 (with 18.4-26 front tires and 7.50-16 rear tires

Length (including cutting platform) .....	27 ft. 5 in. (8.36 m)
Height (over grain tank) .....	9 ft. 6 in. (2.90 m)
Width (right-hand tire to outside edge of platform ladder) .....	12 ft. 2 in. (3.71 m)
Wheel base .....	11 ft. 7 in. (3.53 m)
Ground clearance (under separator) .....	17 in. (432 mm)

SideHill 6600 (23.1-26 front tires and 7.50-16 rear tires)

Length (including cutting platform) .....	27 ft. 9 in. (8.46 m)
Height (over grain tank) .....	10 ft. 2 in. (3.10 m)
Width (right-hand tire to outside edge of platform ladder) .....	13 ft. (3.96 m)
Wheel base .....	12 ft. 5 in. (3.78 m)
Ground clearance (under separator) .....	22 in. (559 mm)

7700 (with 23.1-26 front tires and 11L-16 rear tires)

Length (including cutting platform) .....	27 ft. 5 in. (8.36 m)
Height (over grain tank) .....	9 ft. 6 in. (2.90 m)
Width (right-hand tire to outside edge of platform ladder) .....	13 ft. 3 in. (4.05 m)
Wheel base .....	12 ft. (3.60 m)
Ground clearance (under separator) .....	17 in. (432 mm)

The specifications and design information contained in this manual were correct at the time this machine was manufactured. It is John Deere's policy to continually improve and update our machines. Therefore, the specifications and design information are subject to change without notice. Wherever applicable, specifications and design information are in accordance with SAE and IEMC standards.

**GROUND SPEED IN MPH (km/h) 6600 COMBINE (Posi-Torq Drive)**

**Regular-Duty Final Drives (13 to 89 ratio)**

Size	Tire		Ply	1st Gear		2nd Gear		3rd Gear		4th Gear		Reverse Gear	
	Type												
18.4-26	Cleat		10	.8 to 1.9 (1.3 to 3.1)		1.7 to 4.4 (2.7 to 7.1)		3.2 to 8.0 (5.2 to 12.9)		7.3 to 18.3 (11.8 to 29.5)		1.4 to 3.6 (2.3 to 5.8)	

**Heavy-Duty Final Drives (11 to 90 ratio)**

Size	Tire		Ply	1st Gear		2nd Gear		3rd Gear		4th Gear		Reverse Gear	
	Type												
23.1-26	Cleat		8, 10	.7 to 1.7 (1.1 to 2.7)		1.6 to 3.9 (2.6 to 6.3)		2.9 to 7.2 (4.7 to 11.6)		6.6 to 16.5 (10.6 to 26.6)		1.3 to 3.2 (2.1 to 5.2)	
23.1-26	Low Profile		8	.7 to 1.7 (1.1 to 2.7)		1.5 to 3.8 (2.4 to 6.1)		2.8 to 6.9 (4.5 to 11.1)		6.4 to 16.0 (10.3 to 25.7)		1.2 to 3.1 (2.1 to 5.0)	
23.1-26	Cane & Rice		8, 10	.7 to 1.8 (1.1 to 2.9)		1.7 to 4.2 (2.7 to 6.8)		3.0 to 7.6 (4.8 to 12.2)		7.0 to 17.4 (11.3 to 28.0)		1.4 to 3.4 (2.3 to 5.5)	
28.1-26	Cleat		10	.7 to 1.8 (1.1 to 2.9)		1.6 to 4.0 (2.6 to 6.4)		2.9 to 7.3 (4.8 to 11.8)		6.7 to 16.9 (10.8 to 27.2)		1.3 to 3.3 (2.1 to 5.3)	
28.1-26	Cane & Rice		10	.7 to 1.8 (1.1 to 2.9)		1.7 to 4.2 (2.7 to 6.8)		3.0 to 7.6 (4.8 to 12.2)		7.0 to 17.4 (11.3 to 28.0)		1.4 to 3.4 (2.3 to 5.5)	

**Extra-Heavy Duty Final Drives (11 to 104 ratio)**

Size	Tire or Tracks		Ply	1st Gear		2nd Gear		3rd Gear		4th Gear		Reverse Gear	
	Type												
24.5-32	Cleat		10	.7 to 1.7 (1.1 to 2.7)		1.6 to 3.9 (2.4 to 6.3)		2.8 to 7.1 (4.5 to 11.4)		6.5 to 16.3 (10.5 to 26.2)		1.3 to 3.2 (2.1 to 5.2)	
24.5-32	Cane & Rice		10	.7 to 1.7 (1.1 to 2.7)		1.6 to 4.0 (2.6 to 6.4)		2.9 to 7.3 (4.7 to 11.8)		6.7 to 16.8 (10.8 to 26.2)		1.3 to 3.3 (2.1 to 5.3)	
Tracks				.3 to .8 (.5 to 1.3)		.7 to 1.8 (1.1 to 2.9)		1.3 to 3.3 (2.1 to 5.3)		3.0 to 7.6 (4.8 to 12.2)		.6 to 1.5 (1.0 to 2.4)	

**GROUND SPEED IN MPH (km/h) 6600 COMBINE (Hydrostatic Drive)**

**Regular-Duty Final Drives (13 to 89 ratio)**

Size	Tire		Ply	1st Gear		2nd Gear		3rd Gear		4th Gear	
	Type			Forward	Reverse	Forward	Reverse	Forward	Reverse	Forward	Reverse
18.4-26	Cleat		10	0 to 1.8 (0 to 3.2)	0 to 1.1 (0 to 1.8)	0 to 4.2 (0 to 6.9)	0 to 2.5 (0 to 4.1)	0 to 7.7 (0 to 12.6)	0 to 4.6 (0 to 7.6)	0 to 17.6 (0 to 28.8)	0 to 10.5 (0 to 17.3)

**Heavy-Duty Final Drives (11 to 90 ratio)**

Size	Tire		Ply	1st Gear		2nd Gear		3rd Gear		4th Gear	
	Type			Forward	Reverse	Forward	Reverse	Forward	Reverse	Forward	Reverse
23.1-26	Cleat		8, 10	0 to 1.7 (0 to 2.7)	0 to 1.0 (0 to 1.7)	0 to 3.8 (0 to 6.2)	0 to 2.3 (0 to 3.6)	0 to 6.9 (0 to 11.3)	0 to 4.2 (0 to 6.9)	0 to 16.0 (0 to 26.2)	0 to 9.5 (0 to 15.8)
23.1-26	Low Profile		8	0 to 1.6 (0 to 2.6)	0 to .9 (0 to 1.6)	0 to 3.7 (0 to 6.0)	0 to 2.2 (0 to 3.5)	0 to 6.7 (0 to 10.9)	0 to 4.0 (0 to 6.6)	0 to 15.4 (0 to 25.1)	0 to 9.2 (0 to 15.2)
23.1-26	Cane & Rice		8, 10	0 to 1.7 (0 to 2.8)	0 to 1.0 (0 to 1.7)	0 to 4.0 (0 to 6.6)	0 to 2.4 (0 to 4.0)	0 to 7.3 (0 to 11.9)	0 to 4.4 (0 to 7.3)	0 to 16.8 (0 to 28.0)	0 to 10.0 (0 to 16.6)
28.1-26	Cleat		10	0 to 1.7 (0 to 2.8)	0 to 1.0 (0 to 1.7)	0 to 3.9 (0 to 6.3)	0 to 2.3 (0 to 3.8)	0 to 7.1 (0 to 11.6)	0 to 4.2 (0 to 6.9)	0 to 16.3 (0 to 26.7)	0 to 9.7 (0 to 16.0)
28.1-26	Cane & Rice		10	0 to 1.7 (0 to 2.8)	0 to 1.0 (0 to 1.7)	0 to 4.0 (0 to 6.6)	0 to 2.4 (0 to 4.0)	0 to 7.3 (0 to 11.9)	0 to 4.4 (0 to 7.3)	0 to 16.8 (0 to 27.4)	0 to 10.1 (0 to 16.7)

**Extra-Heavy-Duty Final Drives (11 to 104)**

Size	Tire or Tracks		Ply	1st Gear		2nd Gear		3rd Gear		4th Gear	
	Type			Forward	Reverse	Forward	Reverse	Forward	Reverse	Forward	Reverse
24.5-32	Cleat		10	0 to 1.7 (0 to 2.7)	0 to 1.0 (0 to 1.6)	0 to 3.9 (0 to 6.3)	0 to 2.4 (0 to 3.7)	0 to 7.1 (0 to 11.4)	0 to 4.4 (0 to 7.1)	0 to 16.3 (0 to 26.2)	0 to 10.1 (0 to 16.1)
24.5-32	Cane & Rice		10	0 to 1.7 (0 to 2.7)	0 to 1.1 (0 to 1.8)	0 to 4.0 (0 to 6.4)	0 to 2.5 (0 to 4.0)	0 to 7.3 (0 to 11.8)	0 to 4.5 (0 to 7.2)	0 to 16.8 (0 to 27.0)	0 to 10.4 (0 to 16.7)
Tracks				0 to .8 (0 to 1.3)	0 to .5 (0 to .8)	0 to 1.8 (0 to 2.9)	0 to 1.1 (0 to 1.8)	0 to 3.3 (0 to 5.3)	0 to 2.0 (0 to 3.2)	0 to 7.6 (0 to 12.2)	0 to 4.7 (0 to 7.6)

**GROUND SPEED IN MPH (km/h) 7700 COMBINE (Posi-Torq Drive)**  
**Heavy-Duty Final Drives (11 to 90 ratio)**

Size	Tire		Ply	Gear				Reverse Gear
	Type			1st Gear	2nd Gear	3rd Gear	4th Gear	
23.1-26	Cleat		10	.7 to 1.7 (1.1 to 2.7)	1.6 to 3.9 (2.6 to 6.2)	2.9 to 7.2 (4.7 to 11.7)	6.6 to 16.5 (10.7 to 26.7)	1.3 to 3.2 (2.1 to 5.2)
23.1-26	Low Profile		8	.7 to 1.7 (1.1 to 2.7)	1.5 to 3.8 (2.4 to 6.1)	2.8 to 6.9 (4.5 to 11.1)	6.4 to 16.0 (10.3 to 25.7)	1.2 to 3.1 (2.0 to 5.0)
23.1-26	Cane & Rice		10	.7 to 1.8 (1.1 to 2.9)	1.7 to 4.2 (2.7 to 6.8)	3.0 to 7.6 (4.9 to 12.2)	7.0 to 17.4 (11.3 to 28.1)	1.4 to 3.4 (2.3 to 5.5)
28.1-26	Cleat		12	.7 to 1.8 (1.1 to 2.9)	1.6 to 4.0 (2.6 to 6.4)	2.9 to 7.3 (4.7 to 11.8)	6.7 to 16.9 (10.8 to 27.2)	1.3 to 3.3 (2.1 to 5.3)
28.1-26	Cane & Rice		12	.7 to 1.8 (1.1 to 2.9)	1.7 to 4.2 (2.7 to 6.8)	3.0 to 7.6 (4.8 to 12.2)	7.0 to 17.4 (11.3 to 28.0)	1.4 to 3.4 (2.3 to 5.5)

**Extra-Heavy-Duty Final Drives (11 to 104)**

Size	Tire or Tracks		Ply	Gear				Reverse Gear
	Type			1st Gear	2nd Gear	3rd Gear	4th Gear	
24.5-32	Cleat		10	.7 to 1.7 (1.1 to 2.7)	1.6 to 3.9 (2.6 to 6.3)	2.8 to 7.1 (4.5 to 11.4)	6.5 to 16.3 (10.5 to 26.2)	1.3 to 3.2 (2.1 to 5.2)
24.5-32	Cane & Rice		10	.7 to 1.7 (1.1 to 2.7)	1.6 to 4.0 (2.6 to 6.4)	2.9 to 7.3 (4.7 to 11.8)	6.4 to 16.8 (10.8 to 27.0)	1.3 to 3.3 (2.1 to 5.3)
30.5-32	Cleat		10	.7 to 1.7 (1.1 to 2.7)	1.6 to 3.9 (2.6 to 6.3)	2.9 to 7.2 (4.7 to 11.6)	6.6 to 16.4 (10.6 to 26.4)	1.3 to 3.2 (2.1 to 5.2)
30.5-32	Cane & Rice		10	.7 to 1.8 (1.1 to 2.9)	1.6 to 4.1 (2.6 to 6.7)	3.0 to 7.4 (4.9 to 11.9)	6.8 to 17.1 (11.0 to 27.8)	1.3 to 3.3 (1.8 to 5.3)
Tracks				.3 to .8 (.5 to 1.3)	.7 to 1.8 (1.1 to 2.9)	1.3 to 3.3 (2.1 to 5.3)	3.0 to 7.6 (4.8 to 12.2)	.6 to 1.5 (1.0 to 2.4)

**GROUND SPEED IN MPH (km/h) 7700 COMBINE (Hydrostatic Drive)**  
**Heavy-Duty Final Drives (11 to 90 ratio)**

Size	Tire Type	Ply	1st Gear		2nd Gear		3rd Gear		4th Gear	
			Forward	Reverse	Forward	Reverse	Forward	Reverse	Forward	Reverse
23.1-26	Cleat	10	0 to 1.7 (0 to 2.7)	0 to 1.0 (0 to 1.7)	0 to 3.8 (0 to 6.2)	0 to 2.3 (0 to 3.8)	0 to 6.9 (0 to 11.4)	0 to 4.2 (0 to 6.9)	0 to 16.0 (0 to 26.2)	0 to 9.5 (0 to 15.8)
23.1-26	Low Profile	8	0 to 1.6 (0 to 2.6)	0 to 9.9 (0 to 1.6)	0 to 3.7 (0 to 6.0)	0 to 2.2 (0 to 3.5)	0 to 6.7 (0 to 10.9)	0 to 4.0 (0 to 6.6)	0 to 15.4 (0 to 25.1)	0 to 9.2 (0 to 15.2)
23.1-26	Cane & Rice	10	0 to 1.7 (0 to 2.8)	0 to 1.0 (0 to 1.7)	0 to 4.0 (0 to 6.6)	0 to 2.4 (0 to 4.0)	0 to 7.3 (0 to 11.9)	0 to 4.4 (0 to 7.3)	0 to 16.8 (0 to 28.0)	0 to 10.0 (0 to 16.6)
28.1-26	Cleat	12	0 to 1.7 (0 to 2.8)	0 to 1.0 (0 to 1.7)	0 to 3.9 (0 to 6.3)	0 to 2.3 (0 to 3.8)	0 to 7.1 (0 to 11.6)	0 to 4.2 (0 to 6.9)	0 to 16.3 (0 to 26.7)	0 to 9.7 (0 to 16.0)
28.1-26	Cane & Rice	12	0 to 1.7 (0 to 2.8)	0 to 1.0 (0 to 1.7)	0 to 4.0 (0 to 6.6)	0 to 2.4 (0 to 4.0)	0 to 7.3 (0 to 11.9)	0 to 4.4 (0 to 7.3)	0 to 16.8 (0 to 27.4)	0 to 10.1 (0 to 16.7)

**Extra-Heavy-Duty Final Drives (11 to 104 ratio)**

Size	Tire or Tracks	Ply	1st Gear		2nd Gear		3rd Gear		4th Gear	
			Forward	Reverse	Forward	Reverse	Forward	Reverse	Forward	Reverse
24.5-32	Cleat	10	0 to 1.6 (0 to 2.6)	0 to 1.0 (0 to 1.7)	0 to 3.8 (0 to 6.2)	0 to 2.2 (0 to 3.5)	0 to 6.8 (0 to 11.1)	0 to 4.1 (0 to 6.8)	0 to 15.7 (0 to 25.6)	0 to 9.4 (0 to 15.3)
24.5-32	Cane & Rice	10	0 to 1.7 (0 to 2.7)	0 to 1.0 (0 to 1.7)	0 to 3.9 (0 to 6.3)	0 to 2.3 (0 to 4.0)	0 to 7.1 (0 to 11.8)	0 to 4.2 (0 to 7.2)	0 to 16.2 (0 to 27.0)	0 to 9.7 (0 to 16.7)
30.5-32	Cleat	10	0 to 1.7 (0 to 2.7)	0 to 1.0 (0 to 1.6)	0 to 3.8 (0 to 6.3)	0 to 2.3 (0 to 3.7)	0 to 6.9 (0 to 11.6)	0 to 4.1 (0 to 7.1)	0 to 15.9 (0 to 26.4)	0 to 9.5 (0 to 16.4)
30.5-32	Cane & Rice	10	0 to 1.7 (0 to 2.7)	0 to 1.0 (0 to 1.6)	0 to 3.9 (0 to 6.3)	0 to 2.3 (0 to 3.6)	0 to 7.2 (0 to 11.6)	0 to 4.3 (0 to 7.0)	0 to 16.5 (0 to 26.5)	0 to 9.9 (0 to 15.9)
Tracks			0 to .8 (0 to 1.3)	0 to .4 (0 to .7)	0 to 1.7 (0 to 2.8)	0 to 1.0 (0 to 1.7)	0 to 3.2 (0 to 5.2)	0 to 1.9 (0 to 3.0)	0 to 7.3 (0 to 11.8)	0 to 4.7 (0 to 7.6)

**GROUND SPEED CONTROL RANGE IN MPH (km/h)  
WITH POWER REAR WHEEL DRIVE ENGAGED**

**6600 AND 7700 COMBINES  
(Hydrostatic Drive)**

Tire or Tracks			1st Gear		2nd Gear		3rd Gear		4th Gear	
Size	Type	Ply	Forward	Reverse	Forward	Reverse	Forward	Reverse	Forward	Reverse
23.1-26	Cleat	8	0 to 1.5 (0 to 2.4)	0 to .9 (0 to 1.4)	0 to 3.1 (0 to 5.0)	0 to 1.9 (0 to 3.1)	0 to 4.8 (0 to 7.7)	0 to 2.9 (0 to 4.7)	0 to 7.9 (0 to 12.7)	0 to 4.9 (0 to 7.9)
23.1-26	Cane & Rice	10	0 to 1.6 (0 to 2.6)	0 to 1.0 (0 to 1.6)	0 to 3.2 (0 to 5.1)	0 to 2.0 (0 to 3.2)	0 to 5.1 (0 to 8.2)	0 to 3.2 (0 to 5.1)	0 to 8.3 (0 to 13.4)	0 to 5.1 (0 to 8.2)
24.5-32	Cleat	10	0 to 1.5 (0 to 2.4)	0 to .9 (0 to 1.4)	0 to 3.1 (0 to 5.0)	0 to 1.9 (0 to 3.1)	0 to 4.9 (0 to 7.9)	0 to 3.0 (0 to 4.8)	0 to 8.1 (0 to 13.0)	0 to 5.0 (0 to 8.0)
24.5-32	Cane & Rice	10	0 to 1.5 (0 to 2.4)	0 to .9 (0 to 1.4)	0 to 3.2 (0 to 5.1)	0 to 2.0 (0 to 3.2)	0 to 5.0 (0 to 8.0)	0 to 3.1 (0 to 5.0)	0 to 8.4 (0 to 13.5)	0 to 5.2 (0 to 8.4)
28.1-26	Cleat	10,12	0 to 1.5 (0 to 2.4)	0 to .9 (0 to 1.4)	0 to 3.2 (0 to 5.1)	0 to 1.9 (0 to 3.1)	0 to 5.0 (0 to 8.0)	0 to 3.0 (0 to 4.8)	0 to 8.3 (0 to 13.4)	0 to 5.0 (0 to 8.0)
28.1-26	Cane & Rice	10,12	0 to 1.6 (0 to 2.6)	0 to .9 (0 to 1.4)	0 to 3.2 (0 to 5.1)	0 to 1.9 (0 to 3.1)	0 to 5.1 (0 to 8.2)	0 to 3.1 (0 to 5.0)	0 to 8.5 (0 to 13.6)	0 to 5.1 (0 to 8.2)
30.5-32	Cleat	10	0 to 1.5 (0 to 2.4)	0 to .9 (0 to 1.4)	0 to 3.1 (0 to 5.0)	0 to 1.9 (0 to 3.1)	0 to 5.0 (0 to 8.0)	0 to 3.0 (0 to 4.8)	0 to 8.4 (0 to 13.5)	0 to 5.0 (0 to 8.0)
Tracks			0 to .7 (0 to 1.1)	0 to .4 (0 to .6)	0 to 1.5 (0 to 2.4)	0 to .9 (0 to 1.4)	0 to 2.5 (0 to 4.0)	0 to 1.5 (0 to 2.4)	0 to 4.4 (0 to 7.1)	0 to 2.7 (0 to 4.3)

**GROUND SPEED CONTROL RANGE IN MPH (km/h)  
SIDEHILL 6600 COMBINE**

**(Posi-Torq Drive)**

Size	Type	Tire Ply Rating	1st Gear	2nd Gear	3rd Gear	4th Gear	Reverse Gear
23.1-26	Cleat	10	.7 to 1.7 (1.1 to 2.7)	1.6 to 4.0 (2.6 to 6.4)	2.9 to 7.3 (4.7 to 11.8)	6.7 to 16.7 (10.8 to 26.9)	1.3 to 3.3 (2.1 to 5.3)
23.1-26	Cane & Rice	10	.7 to 1.8 (1.1 to 2.9)	1.7 to 4.2 (1.1 to 6.8)	3.1 to 7.6 (5.0 to 12.2)	7.0 to 17.6 (11.3 to 28.3)	1.4 to 3.4 (2.3 to 5.5)

**(Hydrostatic Drive)**

Tire Ply		1st Gear		2nd Gear		3rd Gear		4th Gear		
Size	Type	Rating	Forward	Reverse	Forward	Reverse	Forward	Reverse	Forward	Reverse
23.1-26	Cleat	10	0 to 1.7 (0 to 2.7)	0 to 1.1 (0 to 1.7)	0 to 4.0 (0 to 6.4)	0 to 2.5 (0 to 4.0)	0 to 7.3 (0 to 11.8)	0 to 4.5 (0 to 7.2)	0 to 16.7 (0 to 26.9)	0 to 10.3 (0 to 16.6)
23.1-26	Cane & Rice	10	0 to 1.8 (0 to 2.9)	0 to 1.1 (0 to 1.7)	0 to 4.2 (0 to 6.8)	0 to 2.6 (0 to 4.2)	0 to 7.6 (0 to 12.2)	0 to 4.7 (0 to 7.6)	0 to 17.6 (0 to 28.3)	0 to 10.9 (0 to 17.5)

# Group 10

## PREDELIVERY, DELIVERY SERVICE, AND AFTER-SALE INSPECTION

### COMBINE PREDELIVERY CONTROLS AND INSTRUMENTS

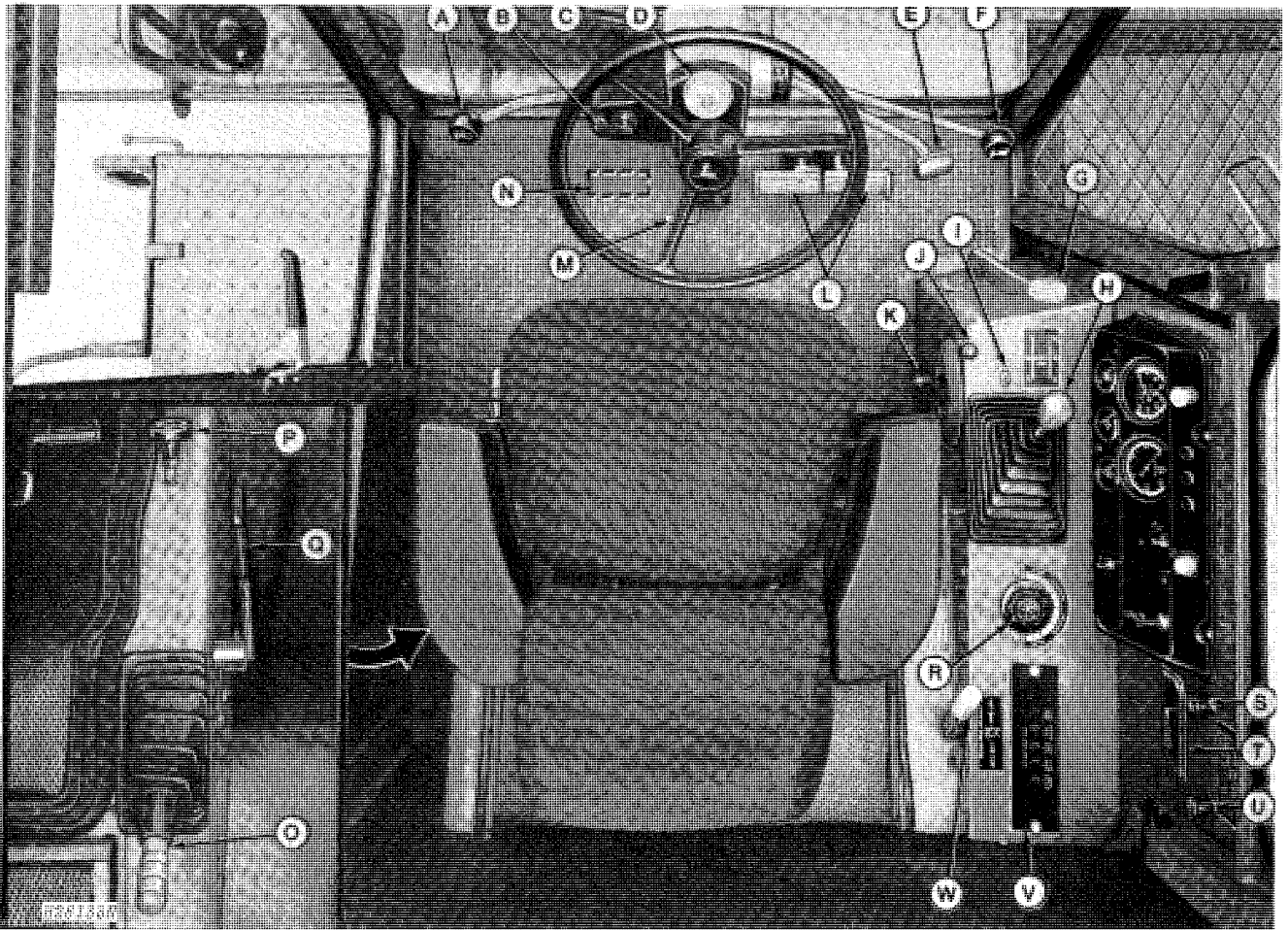

- A—Hydraulic Lift Reel or Variable Speed Feeder House Control
- B—Directional Turn Signals
- C—Steering Wheel
- D—Low Shaft Speed Monitor (Optional)
- E—Hydrostatic Drive Speed Range Control (Optional) or Selective Ground Speed Control
- F—Header Lift Control
- G—Separator Control
- H—Gearshift
- I—Power Rear Wheel Drive (Optional)
- J—Throttle
- K—Concave Opening Control

- L—Brake Pedals
- M—Steering Column Pedal
- N—Clutch Pedal (Posi-Torq)
- O—Parking Brake
- P—Unloading Auger Hydraulic Swing Control
- Q—Grain Tank Unloading Auger Lever
- R—Hydrostatic Drive Reel or Hydrostatic Drive Belt Pickup Control
- S—Cigarette Lighter
- T—Ash Tray
- U—Fuel Shut-Off
- V—Low Shaft Speed Monitor (Optional)
- W—Cylinder Speed Control

Fig. 1-Combine Controls

## CONTROLS AND INSTRUMENTS—Continued

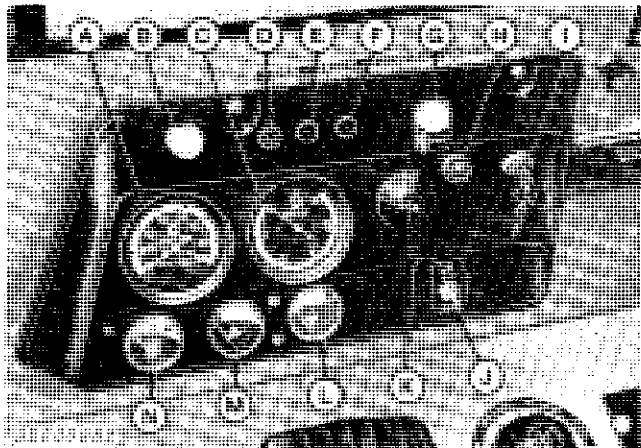

- A—Engine Tach-Hour Meter
- B—Header Electromagnetic Clutch Switch (Optional)
- C—Cylinder Speed Tachometer
- D—Parking Brake Indicator Light
- E—Alternator Indicator Light
- F—Transmission Oil Pressure Indicator Light
- G—Cold Weather Starting Aid Button
- H—Horn Button
- I—Ignition Switch
- J—Automatic Header Height Control Switch (Optional)
- K—Light Switch
- L—Coolant Temperature Gauge
- M—Engine Oil Pressure Gauge
- N—Fuel Gauge

Fig. 2—Console Controls and Instruments

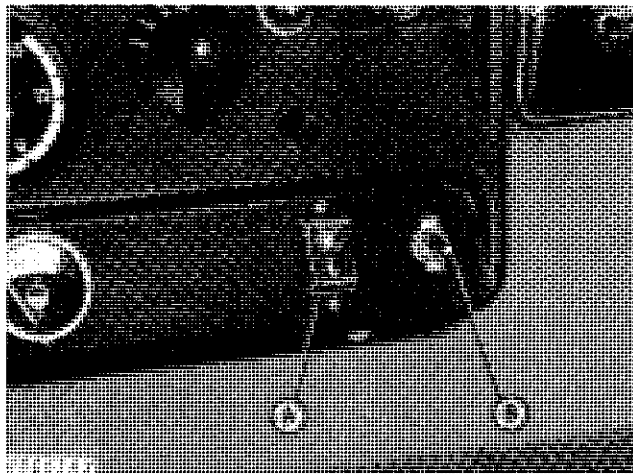

- A—Manual Leveling Control Switch
- B—Leveling Control Cut-Out Switch

Fig. 3—SideHill 6600 Leveling Control and Cut-Out Switches

### Manual Leveling Control Switch

If the leveling system should fail to function or if the operator desires to tilt the separator while on level ground, the leveling system can be controlled by a manual leveling control switch "A," (Fig. 3) located on the instrument panel. This switch will return to neutral position when released.

**IMPORTANT:** Be certain the transmission is in neutral and the parking brake lever is released before tilting combine.

### Leveling Control Cut-Out Switch

By operating this switch, the leveling system can be disengaged.

**IMPORTANT:** Be certain to disengage the leveling system when transporting the combine.

## PRESTARTING CHECKS (Before Unloading Combine)

1. Check the shipment for any shortage, loss, or damage. If any is noted, make the proper notations on the freight bill and immediately notify the carrier.

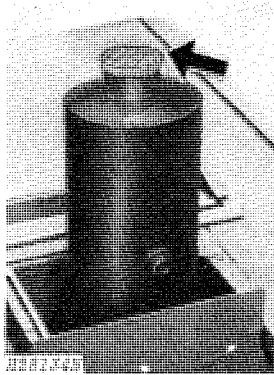

Fig. 4-Exhaust Opening



Fig. 5-Air Intake

2. Remove tape from exhaust opening and from air intake (Figs. 4 and 5). Check to be certain air cleaner filter element is installed and all connections, particularly between the air filter and the engine, are tight.

3. Peel covering from SMV sign on rear hood and remove plastic wrapping from header lift cylinders and from the batteries.

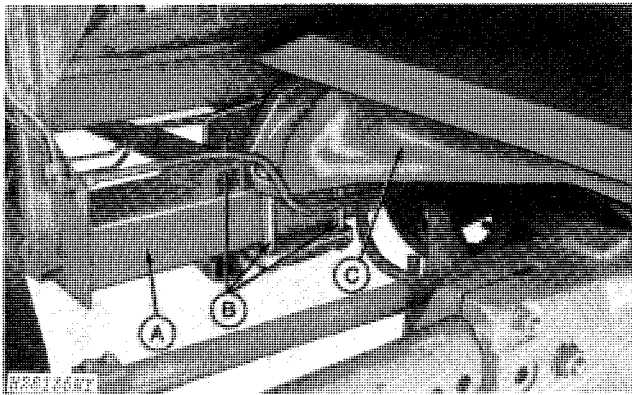

A—Rear Axle Frame  
B—1 x 9-inch Machine Bolts  
C—Rear Axle Support

Fig. 6-Power Rear Wheel Drive Axle Support Bolts

4. (Combines equipped with power rear wheel drive). Tighten the nuts on the six 1 x 9-inch machine bolts "B" (both sides) alternately to 600 ft-lbs (810 Nm) (Fig. 6). After tightening all six nuts, again check nuts to be certain they are tightened to 600 ft-lbs (810 Nm) torque.

5. Before installing the shift cable bracket on 7700 Combines shipped with 30.5-32 drive tires, remove and reverse the right-hand drive wheel. The offset in the wheel should be to the inside. Make certain the clamping ring is placed on the outside of the wheel. Be certain to tighten wheel hub bolts to 300 ft-lbs (400 Nm) torque.

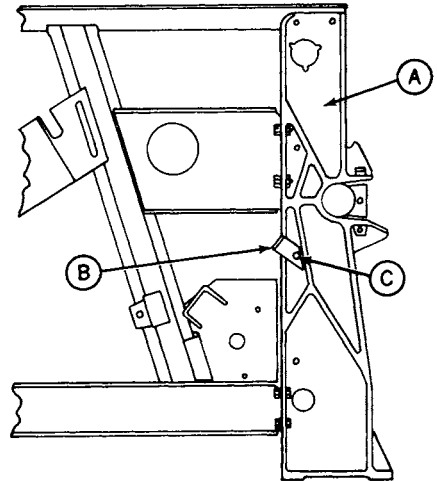

H26093N

A—Right-Hand Separator Upright  
B—Shift Cable Bracket  
C—3/8 x 1-1/2-Inch Round Head Bolt

Fig. 7-Shift Cable Bracket

(Not Illustrated) Remove the two pieces of wire holding the shift cables against the separator before attaching shift cable bracket.

Remove the 3/8 x 1-1/2-inch plow bolt "C", two lock washers, and nut from the right-hand separator upright (Fig. 7). Place one of the lock washers between the separator upright "A" and the bracket "B". Place the other lock washer and nut on the outside of separator upright.

## PRESTARTING CHECKS—Continued

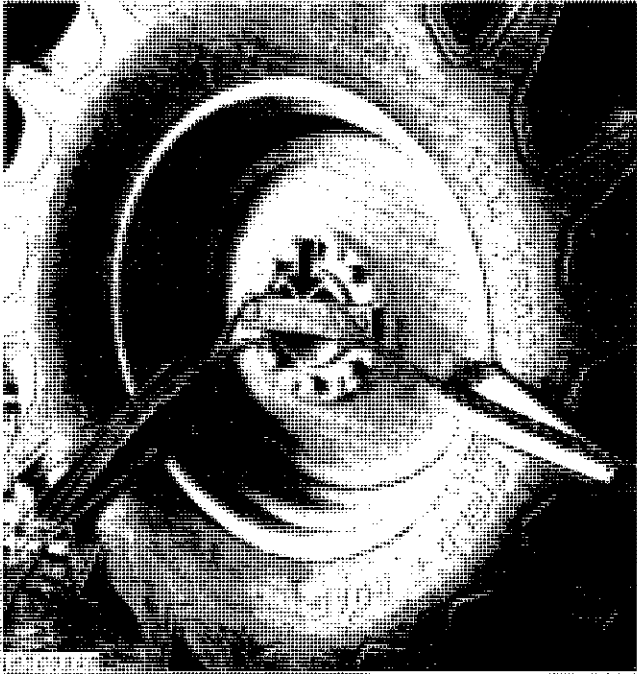

Fig. 8-Removing Shipping Straps

6. Remove shipping strap (both sides) and discard the two cap screws (Fig. 8). Replace the two cap screws with the two flanged bolts shipped in a plastic bag in the tool box. Remove all wood blocking.

*NOTE: The wheel bolt socket is no longer provided with each combine from the factory. It is available as a service part.*

7. Check all drive wheel bolts to be certain they are tight (300 ft-lbs [400 Nm] torque).

Check all steering wheel bolts to be certain they are tight:

80 ft-lbs (110 Nm) torque-6 bolt wheel - 6600, SideHill 6600, 7700

120 ft-lbs (160 Nm) torque-8 bolt wheel - 7700

8. Make certain oil in crankcase, transmission, final drives, hydraulic reservoir, and hydrostatic reservoir is at proper level.

*NOTE: (SideHill 6600 Combine) Approximately 3 U.S. qts. (2.9 l) of hydraulic oil has been removed from the hydraulic system to lower the combine height and to stabilize the leveling system during shipment. Be certain to add approximately 3 U.S. qts. (2.9 l) of hydraulic oil to the reservoir, to bring the oil to the proper level.*

Be certain to add approximately 3 U.S. qts. (2.9 l) of hydraulic oil to the reservoir, to bring the oil to the proper level.

9. Make certain radiator is filled to proper level. If necessary, add coolant slowly until level is 1-inch (25 mm) below filler neck.

10. Make certain that the combine brakes are working and the parking brake lever is released before attempting to move combine.

11. Adjust tire shipping air pressure to proper operating pressure shown below.

Tire Size	Ply Rating	Air Pressure (Psi)
<b>Drive Tires</b>		
18.4-26 (6600)	10	30 (2.35 bar)
23.1-26 (6600)	8	22 (1.50 bar)
23.1-26 (6600)	10	24 (1.65 bar)
23.1-26 (SideHill 6600)	10	26 (1.80 bar)
24.5-32 (6600)	10	22 (1.50 bar)
24.5-32 (7700)	10	24 (1.65 bar)
28.1-26 (SideHill 6600)	10	22 (1.50 bar)
28.1-26 (7700)	12	26 (1.80 bar)
30.5-32 (7700)	10	20 (1.40 bar)
<b>Steering Tires</b>		
9.00-24 (All)	6	26 (1.80 bar)
9.50-24 (All)	6	34 (2.35 bar)
11.00-16 (All)	6	32 (2.20 bar)
11L-16 (6600)	6	28 (1.90 bar)
11.2-24 (All)		30 (2.05 bar)
14.9-24* (6600)	6	20 (1.40 bar)
16.9-26* (7700)	6	18 (1.25 bar)

\*Combines equipped with power rear wheel drive

## UNLOADING COMBINE FROM FREIGHT CAR OR TRUCK

If the combine is to be moved to the set-up area under its own power, the following must be done.

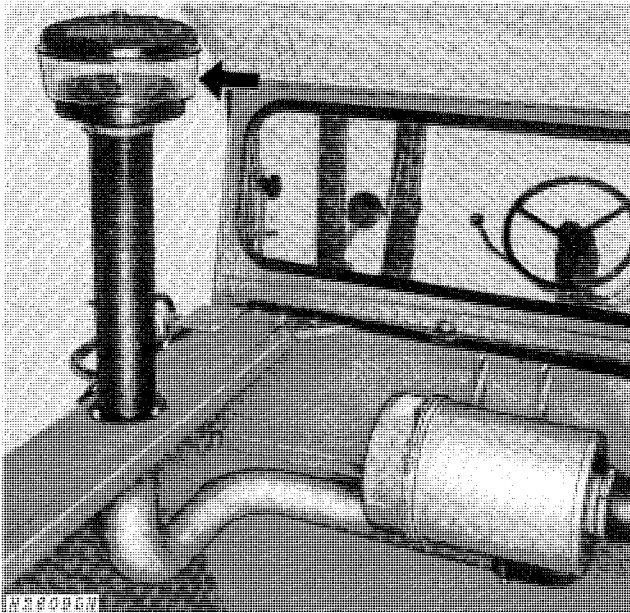

Fig. 9-Attaching Precleaner

1. Attach precleaner to airstack (Fig. 9).

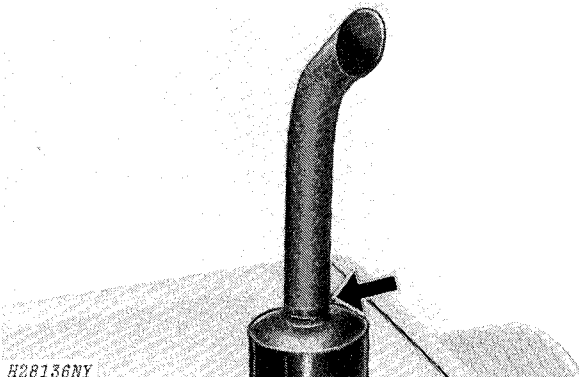

Fig. 10-Attaching Exhaust Extension

2. Attach engine exhaust extension with clamp (Fig. 10). Be certain extension opening is positioned to the rear.

3. The combine is shipped with the batteries "wet" or activated. Therefore, the alternator has been connected at the factory. Connect battery ground straps.

**CAUTION:** Do not engage separator control (10-10-1, Key G).

4. Adjust propelling drive belts to proper tension.
5. Make certain that the combine brakes are working and the parking brake lever is disengaged before attempting to move combine.
6. (SideHill 6600 Combine) Rephase leveling cylinders as follows:

- A. Place transmission in neutral and release parking brake.

Refer to page 10-10-17 ENGINE OPERATING PROCEDURE, before attempting to start engine.

- B. Start combine engine and tilt combine to each side. Refer to page 10-10-2. Hold in that position for 15 seconds, then allow combine to return to level position. Repeat this procedure three times to insure complete rephasing of the leveling cylinders.

**IMPORTANT:** Check to be certain both leveling cables return to the grooves in the cable sheaves.

- C. Check all hydraulic connections to be certain they are tight.

**CAUTION:** When unloading the combine and shipping bundles from the freight car or truck, use a substantial unloading dock. When using a ramp, set the wheel brakes and block the wheels of the freight car or truck.

7. If combine is to be stored, see page 10-10-19 for temporary storage instructions.

## ASSEMBLY

### Installing Ladder Landing

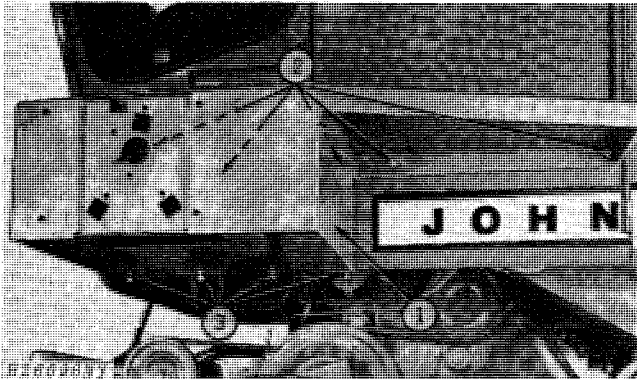

Fig. 11-Installing Ladder Landing

1. Before installing ladder landing, screw two 5/16 x 1/2-inch self-tapping screws into back of landing until screw heads are 1/8-inch (3 mm) from landing (Fig. 11).

Remove the 3/8 x 3/4-inch machine screw in skirt, or it will cause a gap when ladder landing is installed.

**CAUTION:** The approximate weight of the ladder landing is 75 lbs. (34 kg).

2. Lift ladder landing into place and attach with existing hardware. Be certain slots in front and rear skirts slip down on the two screws installed in Step 1 (Fig. 11). Tighten screws.

3. Attach ladder landing with four 3/8 x 7/8-inch cap screws (Fig. 11).

### Installing Pivoting Ladder

Instructions for installing pivoting ladder are included in the pivoting ladder bundle.

### Installing Fixed Ladder (Grain Combines Only)

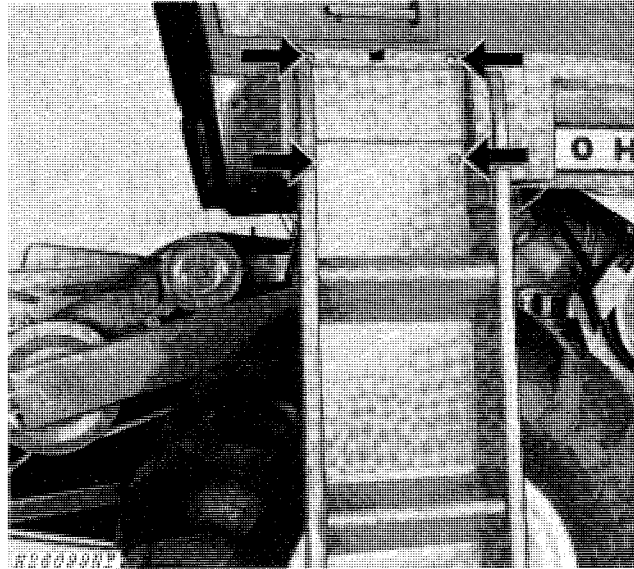

Fig. 12-Installing Fixed Ladder

Attach fixed ladder to ladder landing with four 3/8 x 7/8-inch round head bolts and nuts (Fig. 12).

### Cab Mirror, Lights, and Handrails

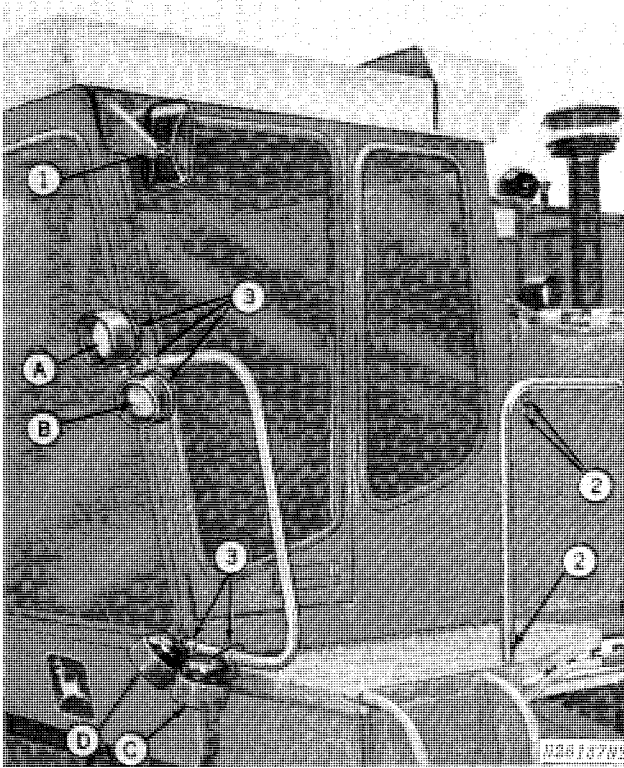

Fig. 13-Installing Cab Mirror, Lights, and Handrails

1. Attach mirror to mounting bracket with a 1/4 x 3/4-inch cap screw (Fig. 13).

2. Attach rear handrail to grain tank with two 3/8 x 1-inch cap screws, lock washer and nuts (Fig. 13).

Attach rear handrail to ladder landing with one 3/8 x 1-inch cap screw, lock washer and nut (Fig. 13).

3. Attach each of the four lights to the front handrail with two clamp halves, one 1/2 x 2-inch cap screw and lock washer (Fig. 13).

Thread wires through handrail. Do not tighten clamps at this time.

**NOTE:** Be certain to place each light in its proper position as follows:

Light	Area Illuminated	Watts	Lens Pattern
A	Field and Road	80 (Dual Beam)	
B	End of Header	60	
C	Stubble	18	
D	Header Auger	18	

4. Attach front handrail with lights to cab with three 3/8 x 3/4-inch cap screws and lock washers (Fig. 13).

Position lights as illustrated and tighten clamps.

5. Insert rubber grommet in panel and thread wires through grommet (Fig. 13).

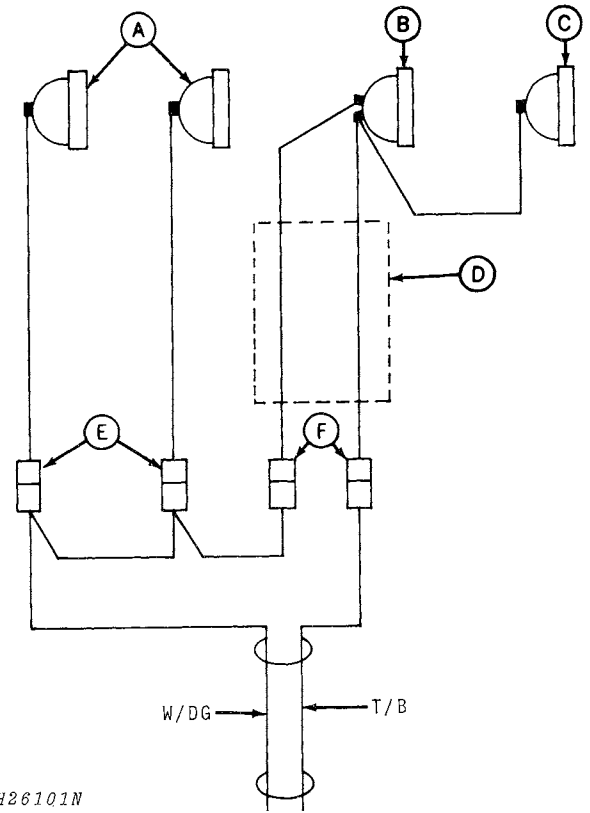

- A—18 Watt Lights
- B—80 Watt (Dual Beam) Light
- C—60 Watt Light
- D—Front Handrail
- E—Spade-Type Connectors
- F—Bullet-Type Connectors

Fig. 14-Wiring Schematic for Connecting Lights

6. Refer to Fig. 14 and connect lights.

## Unloading Auger

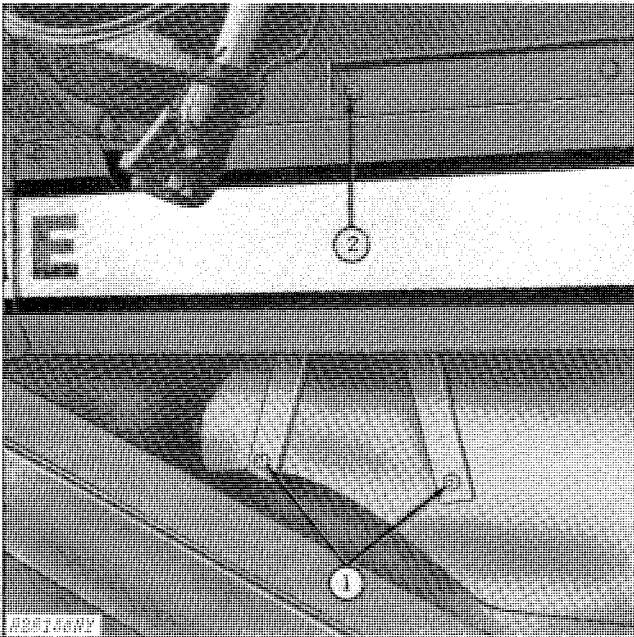

Fig. 15-Removing Shipping Braces

1. Remove and discard the two 5/16 x 3/4-inch cap screws, lock washers, and nuts attaching the two shipping braces to the unloading auger (Fig. 15).

2. Remove and discard the 5/16 x 1/2-inch cap screw, lock washer, and nut in the combine style line (Fig. 15). Discard the two shipping braces and insert a 5/16 x 1/2-inch self-tapping screw in the style line.

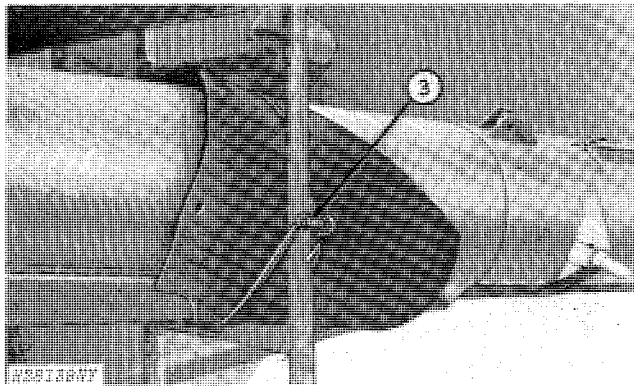

Fig. 16-Removing Unloading Auger from Under Combine

3. Cut shipping wire securing unloading auger to the separator ladder (Fig. 16). Slide auger and rubber spout out from under combine.

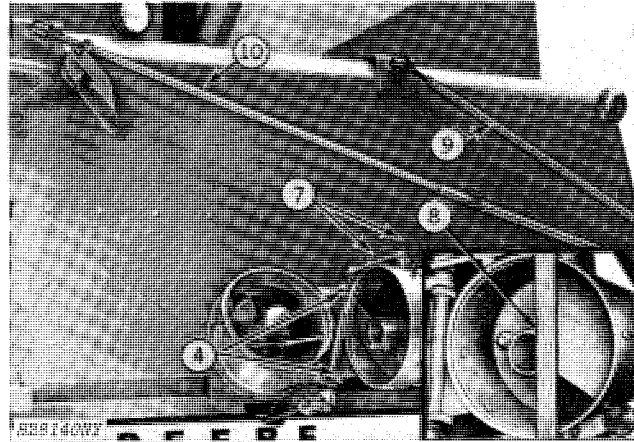

Fig. 17-Installing Unloading Auger

4. Position outer hinge inside inner hinge (Fig. 17).

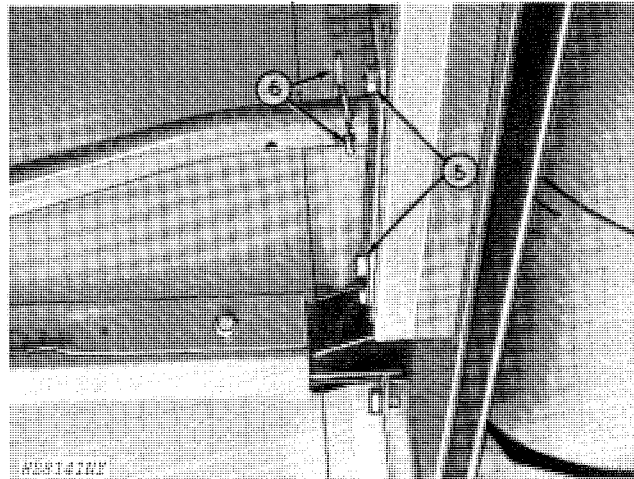

Fig. 18-Adjusting Transport Tube Support

5. Loosen the two nuts on support (Fig. 18).

6. Position auger back against grain tank and insert spring pin through locking stud (Fig. 18). Tighten the two nuts on the support.

7. Loosen two cap screws and insert hinge pin through hinges (Fig. 17). With pin holes aligned, slide hinge pin into swing arm and install a 3/16 x 1-3/4-inch spring pin. Tighten cap screws.

8. Place a straight edge ruler across open end of housing (Fig. 17). Auger tube must be flush with housing. Add or remove 49/64 x 1-1/2 x .134-inch flat washers between bearing and end of auger for correct adjustment.

9. Attach auger support rod (Fig. 17). Adjust rod until locking stud fits freely in transport support.

10. Attach upper end of the telescoping auger braces with a drilled pivot pin and a 3/16 x 1-1/2-inch spring pin (Fig. 17). Attach the lower end of the braces with a 1/2 x 2-1/4-inch drilled pin and a 3/16 x 1-inch cotter pin.

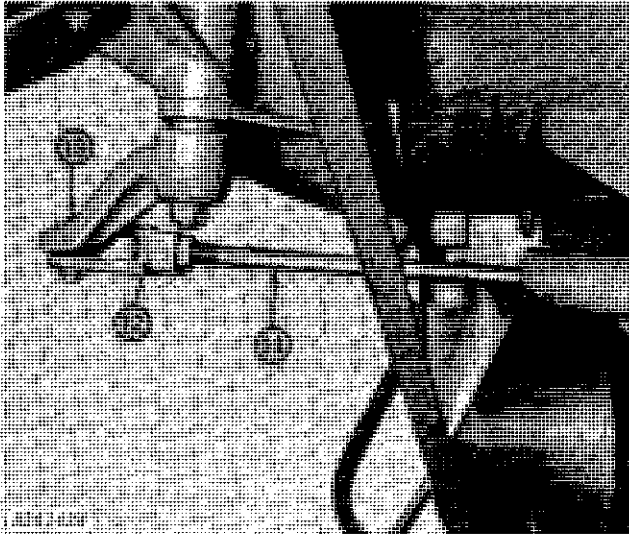

Fig. 19-Connecting Piston Rod Yoke to Hinge Pin Arm

11. Start combine engine and activate hydraulic swing control until piston rod is completely extended. Shut off engine (Fig. 19).

12. With auger locked against separator, thread lock nut on piston rod, then thread yoke on piston rod until holes in yoke and hinge pin arm align (Fig. 19).

13. Insert drilled pin in hinge pin arm. Insert cotter pin and tighten lock nut on piston rod (Fig. 19).

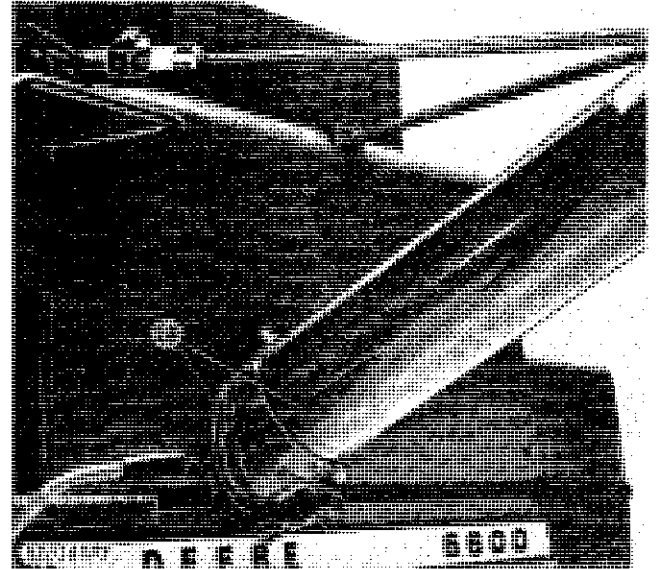

Fig. 20-Adjusting Over-Center Lock

14. Start combine engine and swing auger into unloading position and work over-center lock (Fig. 20).

If lock does not properly seal outer auger to inner auger, then release over-center lock, loosen lock nut, and rotate lock as required.

When seals match properly, tighten lock nut.

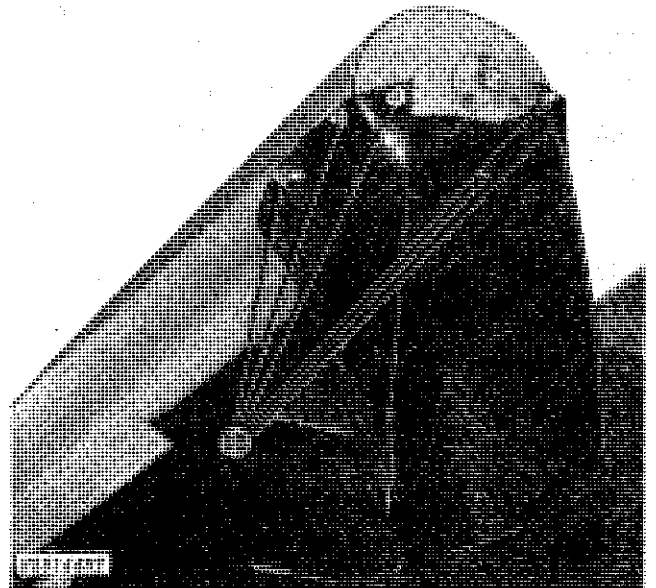

Fig. 21-Installing Auger Spout

15. Attach spout with six 5/16 x 1-inch cap screws, six 11/32 x 1-3/8 x .120-inch washers, and twelve nuts (Fig. 21).

**IMPORTANT:** Be certain to place nuts on the outside of rubber auger spout.

## Drive Wheels

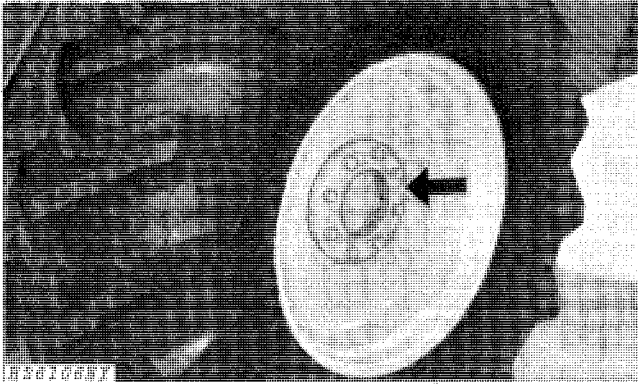

Fig. 22-Clamping Ring

On combines equipped with 24.5-32, 28.1-26, or 30.5-32 tires, be certain clamping ring is installed (Fig. 22).

If combine is to be used to harvest row crops, refer to combine operator's manual for wheel spacing information.

**IMPORTANT: When changing or replacing wheels, always, tighten wheel bolts to 300 ft-lbs (400 Nm) torque. Retighten bolts once after 1 hour of operation and every 10 hours of operation until bolts remain tight.**

## Grain Tank Drain Hole Cover

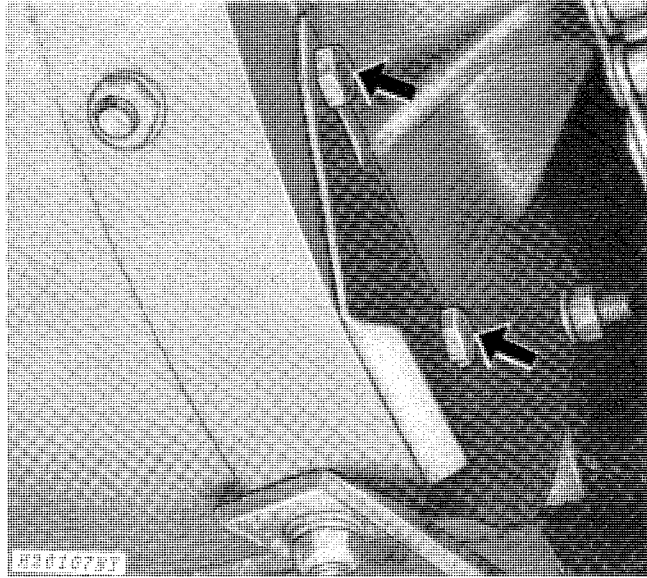

Fig. 23-Installing Grain Tank Drain Hole Cover

The grain tank drain hole cover is shipped in the bag of parts. Install the cover with two 5/16 x 1/2-inch cap screws, two 11/32 x 11/16 x .060-inch flat washers, and two lock washers (Fig. 23).

## Cigarette Lighter

The cigarette lighter is shipped in the bag of parts. Install the lighter in the firewall.

## Installing Rotary Cooling Screen

1. Remove mud fender from top of chaffer. Remove rotary screen from inside rear hood, by removing a 3/8 x 1-3/4-inch cap screw and lock washer. Save hardware. Remove vacuum duct from inside cab.

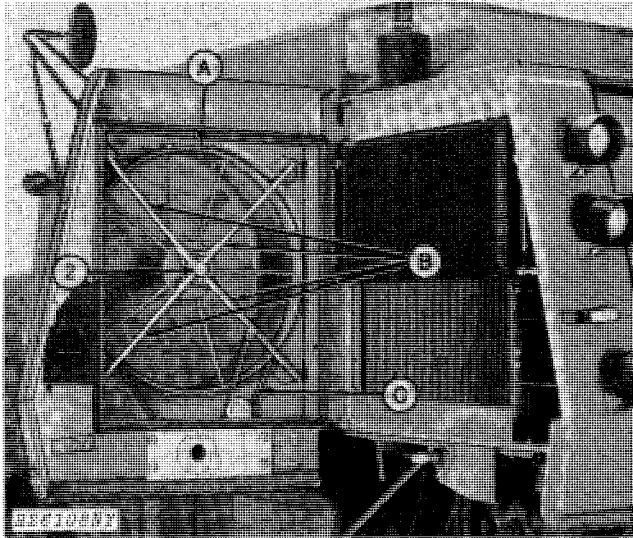

A—Screen Drive Ring      C—Drive Belt  
 B—Spider Arms

Fig. 24-Attaching Rotary Screen

2. Place drive belt "C" on screen drive ring "A" (Fig. 24). Lift screen into place and secure to spider arms "B" with 3/8 x 1-3/4-inch cap screw and lock washer removed in Step 1.

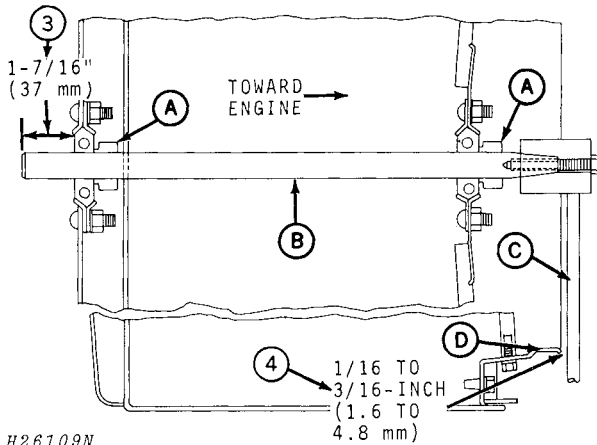

H26109N

A—Locking Collar      C—Spider Arm  
 B—Drive Shaft      D—Screen Drive Ring

Fig. 25-Adjusting Drive Shaft

3. Check to be certain distance between end of rotary screen drive shaft "B" and the bearing is 1-7/16-inch (37 mm) (Fig. 25). If this distance is not correct, loosen set screw in locking collar "A" and slide collar in or out as necessary. Tighten set screw.

4. Check to be certain the minimum distance between the closest spider arm "C" and screen drive "D" is 1/16 (1.6 mm) to 3/16-inch (4.8 mm) while rotating screen (Fig. 25). If this distance is not correct, loosen set screw in locking collar "A" and slide collar in or out as necessary. Tighten set screw.

**IMPORTANT:** Brush seal must contact and ride on the outside of door sheet angle. The distances in Steps 4 and 5 must be correct before performing the following steps.

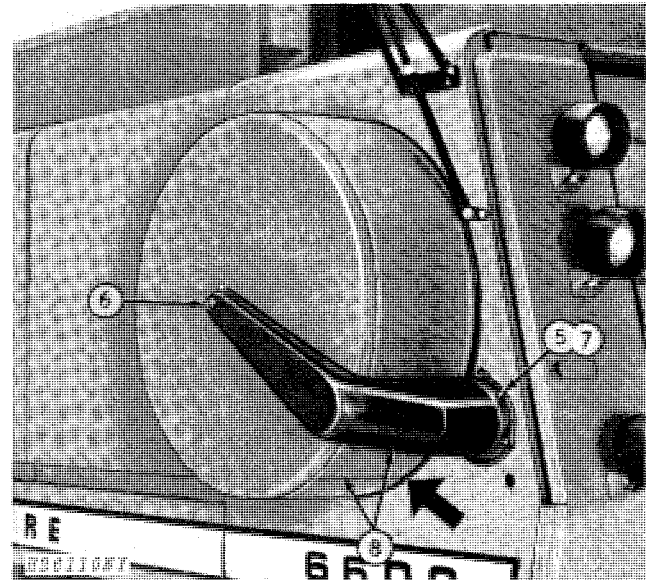

Fig. 26-Installing Vacuum Duct

5. Remove the five 1/4 x 1-inch self-tapping screws attaching duct mounting to screen door (Fig. 26). Save hardware.

6. Attach vacuum duct to drive shaft with the 3/8 x 1-1/4-inch black cap screw, flat washer, and lock washer provided (Fig. 26). Just start cap screw into shaft a few threads at this time.

7. Position vacuum duct over duct mounting and attach to screen door with the five 1/4 x 1-inch self-tapping screws removed in Step 5 (Fig. 26). Do not tighten screws at this time.

8. The bottom edge of vacuum duct must just clear the screen weld seam as the screen rotates (Fig. 26). Slide duct in or out to obtain this clearance. Tighten all hardware.

## Installing Rotary Cooling Screen —Continued

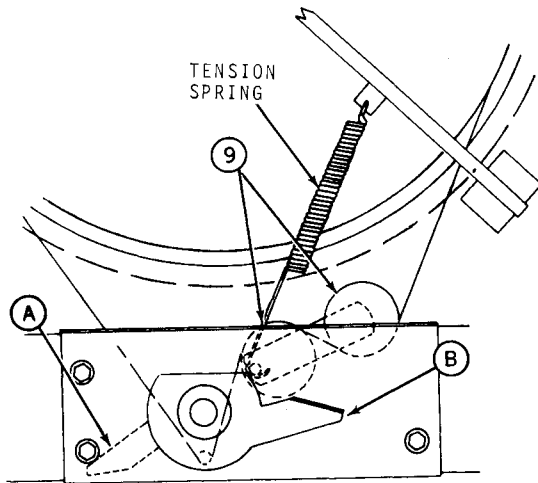

H26111N

A—Drive Engaged

B—Drive Disengaged

Fig. 27-Engaging and Disengaging Screen Drive

9. Position drive belt over tighteners, engage drive, and install tension spring (Fig. 27). To engage drive, move lever down and forward "A." To disengage drive, move lever down and rearward "B."

**IMPORTANT: Screen door must be closed and locked to engage or disengage drive.**

After installation of rotary screen, run engine at idle speed and check to be certain screen does not rub vacuum duct. Adjust duct if necessary.

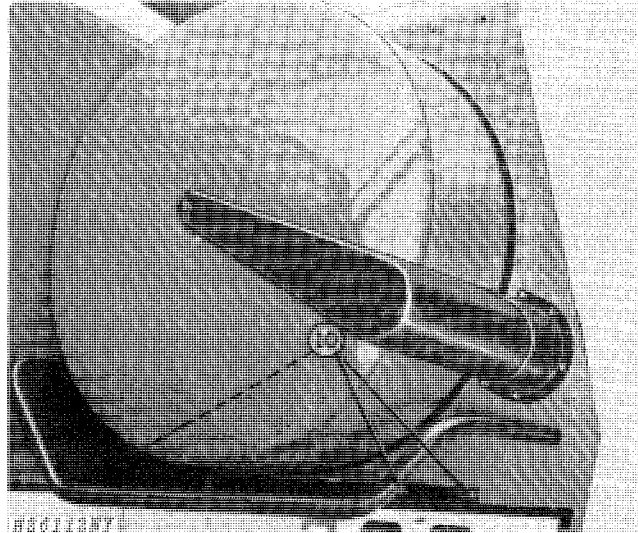

Fig. 28-Attaching Mud Fender (Outside)

10. Attach mud fender to screen door with three 1/4 x 5/8-inch self-tapping screws and three 9/32 x 5/8 x .060-inch washers (Fig. 28).

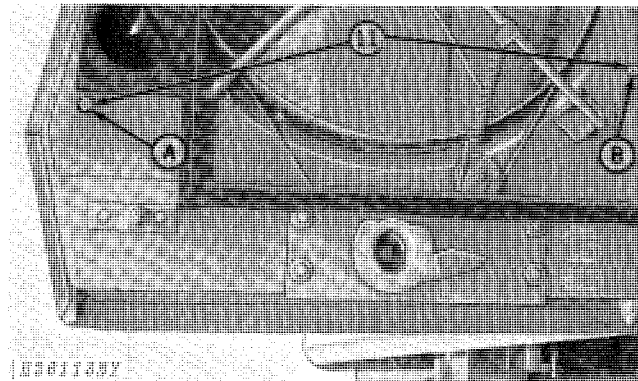

Fig. 29-Attaching Mud Fender (Inside)

11. Attach front fender brace to door at "A" with one 1/2 x 1-1/4-inch cap screw, one 33/64 x 7/8 x .048-inch washer, lock washer, and nut (Fig. 29). Attach rear fender brace to door at "B" with one 1/2 x 3-inch cap screw, one 33/64 x 7/8 x .048-inch washer, lock washer, and nut.

**IMPORTANT: When operating the combine in below freezing temperatures, be certain the rotary screen is free to turn before starting the engine. An accumulation of snow or frozen moisture could prevent the rotary screen from turning, resulting in belt failure.**

## CHECKS AND ADJUSTMENTS

Refer to Group 20 of this section and completely lubricate the combine.

Make certain oil in crankcase, transmission, final drives, hydraulic reservoir, and hydrostatic reservoir is at proper level.

Make certain radiator is filled to proper level.

Turn on ignition switch and pressurizer fan switch. Be certain fan operates at all three speeds.

Turn on air conditioner switch and make certain air conditioning system functions properly. The engine must be running for this step.

Turn off air conditioner switch and turn on heater switch to be certain heater functions.

Check to be certain heater hose cools down when heater is turned off. If hose remains hot, refer to Section 80.

Check fluid levels and make certain combine brakes are working. If they do not operate properly, refer to Section 60.

Check tow-in of steering wheels. See operator's manual.

Check for proper alignment of all sheaves.

Check for proper tension of all drive chains. Chains should be just tight enough to run without climbing or jumping sprockets.

Check for proper tension of all drive belts. Belts will stretch more in the first 50 hours of operation than in their entire service life.

The adjustable chaffer and adjustable sieve are shipped from the factory in the closed position. Adjust, as necessary, for the crop to be harvested. (See combine operator's manual for recommended setting for various crops.)

Check to be certain stone trap door is closed.

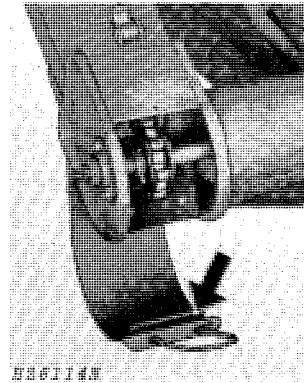

Fig. 30-Tailings Elevator

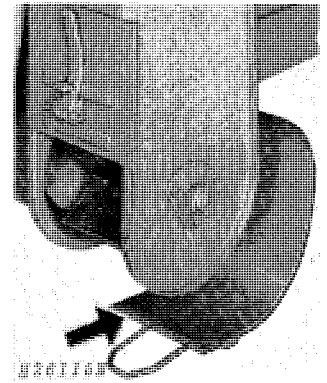

Fig. 31-Clean Grain Elevator

Be certain lip on tailings elevator (Fig. 30) and clean grain elevator (Fig. 31) doors are positioned inside the elevators.

### Primary Countershaft

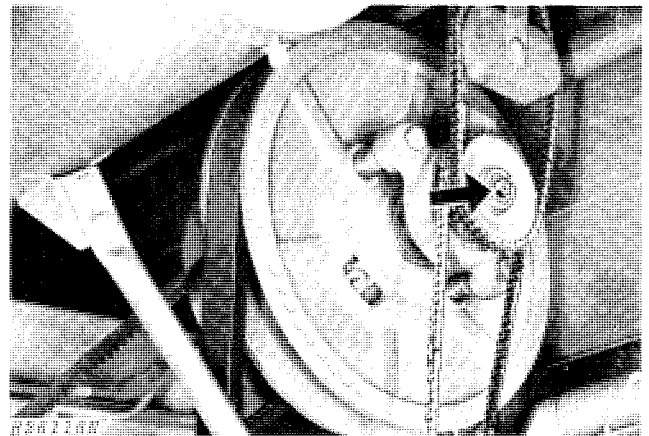

Fig. 32-Primary Countershaft

The primary countershaft operates at 1500-1510 rpm when the combine engine is operating at full throttle—no load (Fig. 32).

The primary countershaft speed determines the basic separator speed. All drives, except ground travel speed, depend upon proper primary countershaft speed; therefore, it is vital that the primary countershaft operate at correct speed.

Check the countershaft speed at the right-hand end. Use a mechanical revolution counter—never guess.

If the speed is not correct, check drive belts and adjust tension if necessary. See operator's manual.

If the speed is still not correct, refer to operator's manual to correct engine speed.

## Leveling Rasp-Bar and Spike-Tooth Concaves

1. (Not Illustrated) Turn concave control wheel until front of concave is completely closed.

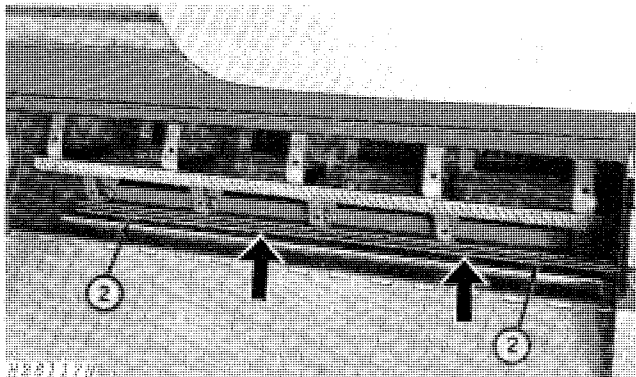

Fig. 33-Space Between A Rasp-Bar and Second Concave Grate Bar

2. At each end of the cylinder, measure the space between a rasp-bar and the second concave grate bar from the front (Fig. 33).

At each end of the spike-tooth cylinder, measure the space between the cylinder and concave teeth support.

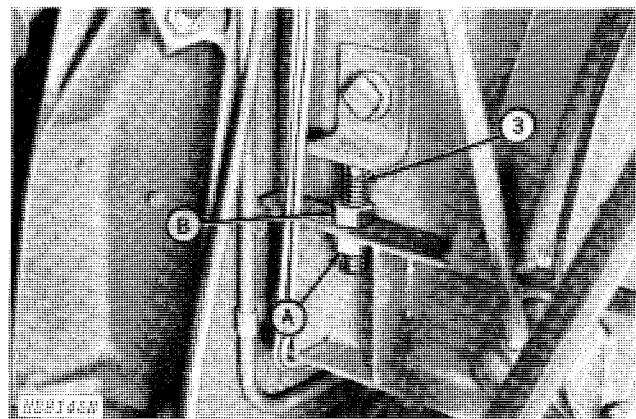

Fig. 34-Concave Leveling Bolt

3. If the two measurements are not equal, level the concave with the adjusting bolt on the left-hand side (Fig. 34).

To raise concave, loosen nut "A" and tighten nut "B" (Fig. 34). To lower concave, loosen nut "B" and tighten nut "A."

Turn control wheel to desired setting.

## Proportioning Rasp-Bar Concave To Cylinder

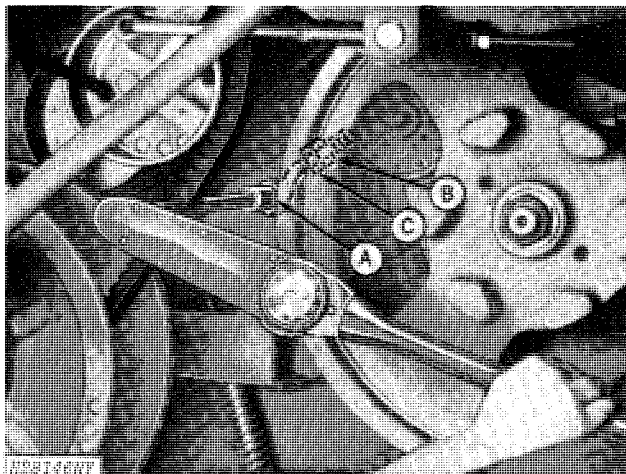

Fig. 35-Concave Proportioning Adjusting Bolt

After concave is level, set concave so there is a 3/16-inch (5 mm) space between a rasp-bar and the second concave grate bar. Then, on both sides, loosen nuts "A" and "B" and tighten nut "C" (Fig. 35) until rear of concave just touches cylinder. Tighten nut "B." Tighten nut "A" to 150 ft-lbs (203 Nm) torque.

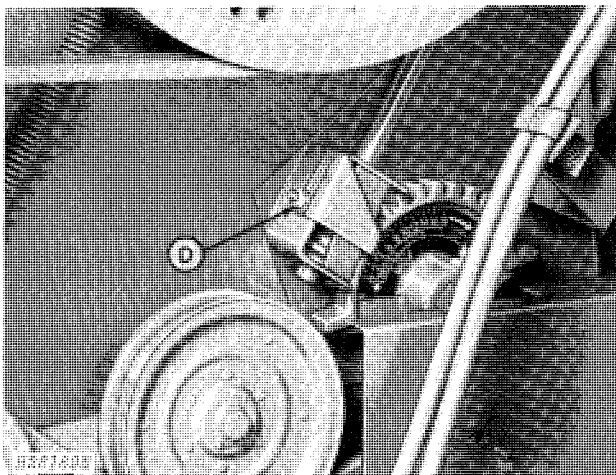

Fig. 36-Concave Pointer

Loosen bolt "D" and adjust pointer until it is on "0" (Zero) (Fig. 36). Tighten bolt "D."

## Positioning Rear of Spike-Tooth Concave to Cylinder

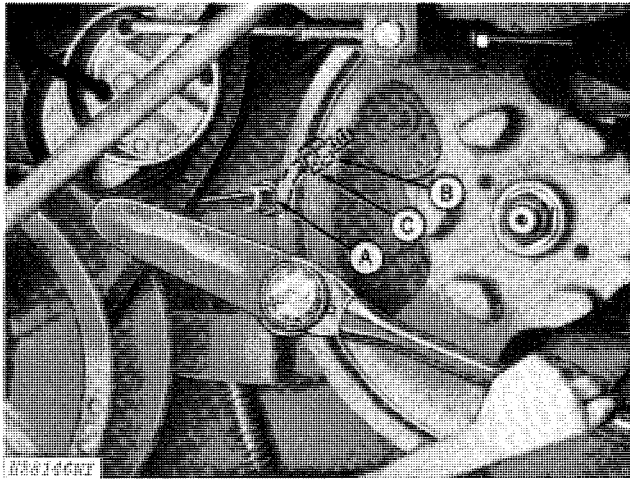
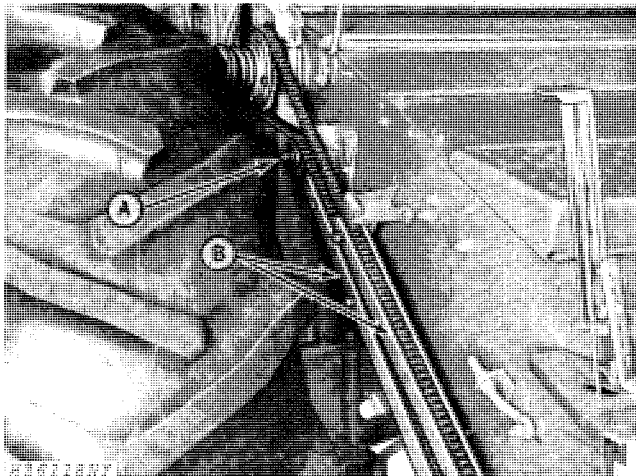

Fig. 37-Concave Positioning Adjusting Bolt

After concave is level, be certain rear adjusting bolt (both sides) are at bottom of slots. Loosen nuts "A" and "B" and adjust nut "C" until adjusting bolt is at bottom of slot (Fig. 37). Tighten nut "B." Tighten nut "A" to 150 ft-lbs (203 Nm) torque.

## Adjusting Feeder Conveyor Drive Chain



A—Chain Tightener Sprocket B—Wood Chain Guides

Fig. 38-Adjusting Chain

Loosen nut "A" and push sprocket upward until the chain will operate without climbing or jumping sprockets (Fig. 38).

After adjusting chain, adjust the wooden guides so they are directly under the chain with a slight clearance between the chain and ends of guides.

Do not use the guides as tighteners.

## Adjusting Feeder Conveyor Chain

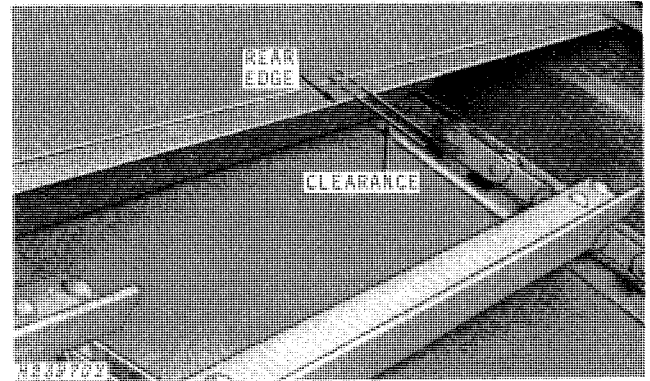

Fig. 39-Adjusting Conveyor Chain

On left-hand side of feeder house, look down along rear edge of door opening and check clearance between bottom of conveyor chain and wear strip on feeder house torque frame. Clearance should be 1/16 to 1/8-inch (1.5 to 3 mm) on regular length feeder houses and 0 to 1/16-inch (0 to 1.5 mm) on long feeder houses (Fig. 39).

Equalize chain tension on right-hand side. Do not use above dimensions when adjusting right-hand side of conveyor.

## Adjusting Feeder Conveyor "Float"

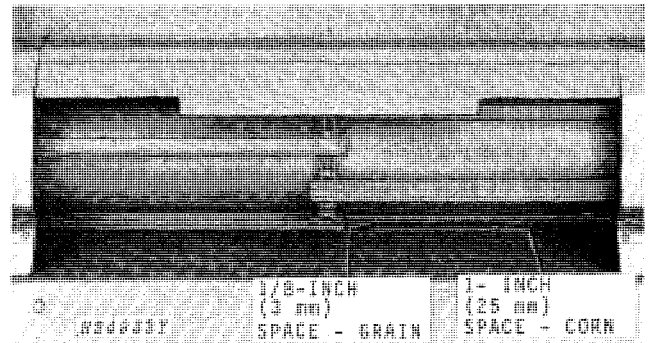

Fig. 40-Conveyor Chain Space

Adjust feeder conveyor chain so a 1/8 or 1-inch (3 to 25 mm) space exists between the feeder conveyor slats and the feeder house bottom directly under the feeder drum (Fig. 40).

### Adjusting Feeder House Drive Chains (SideHill 6600)

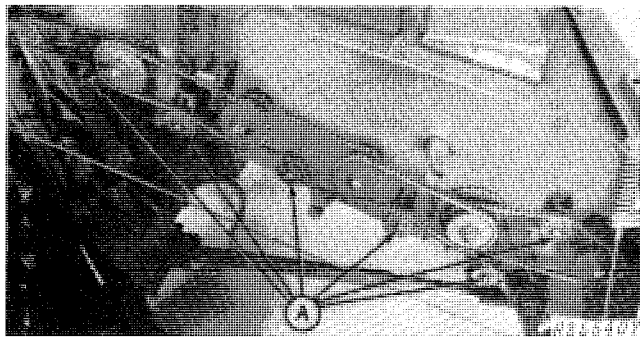

Fig. 41-Feeder House Drive Chains

Loosen nuts "A" and push sprockets upward until the chains will operate without climbing or jumping sprockets (Fig. 41).

### Adjusting Front Feeder House Paddle Height (SideHill 6600)

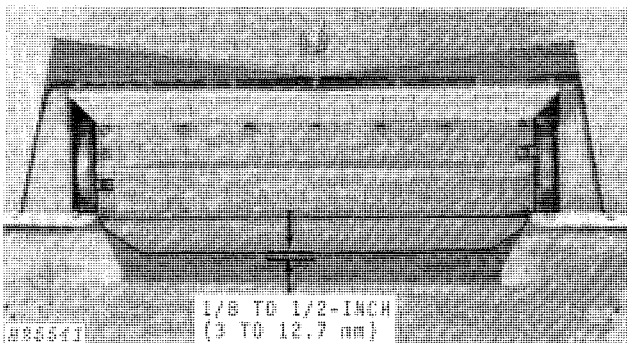

Fig. 42-Paddle Height

Adjust front feeder house paddle so a 1/8 to 1/2-inch (3 to 12.7 mm) space exists between the paddle edge and the feeder house bottom (Fig. 42). See operator's manual.

### Adjusting Front Feeder House Paddle Stripper (SideHill 6600)

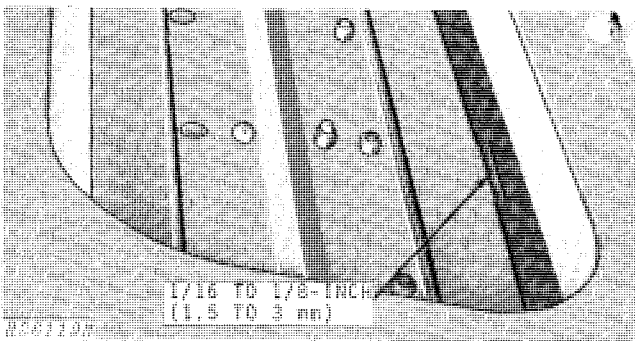
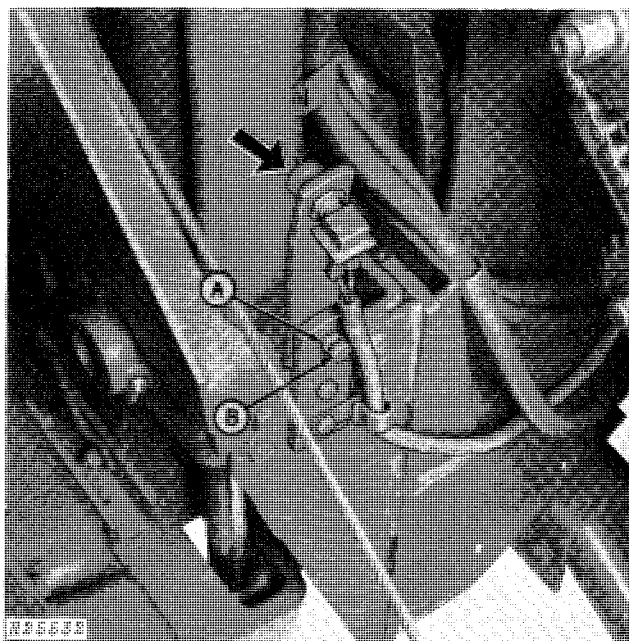

Fig. 43-Paddle Stripper

Adjust the front feeder house paddle stripper so a 1/16 to 1/8-inch (1.5 to 3 mm) clearance exists between the stripper and the edge of the paddle (Fig. 43).

Litho in U.S.A.

### Adjusting Tilt Limit Switches (SideHill 6600)



A—Lock Nut

B—Adjusting Bolt

Fig. 44-Left Tilt Limit Switch

The right and left tilt limit switches are located in front of the leveling cylinders. See operator's manual.

### Adjusting Leveling Sensing Control Box (SideHill 6600)

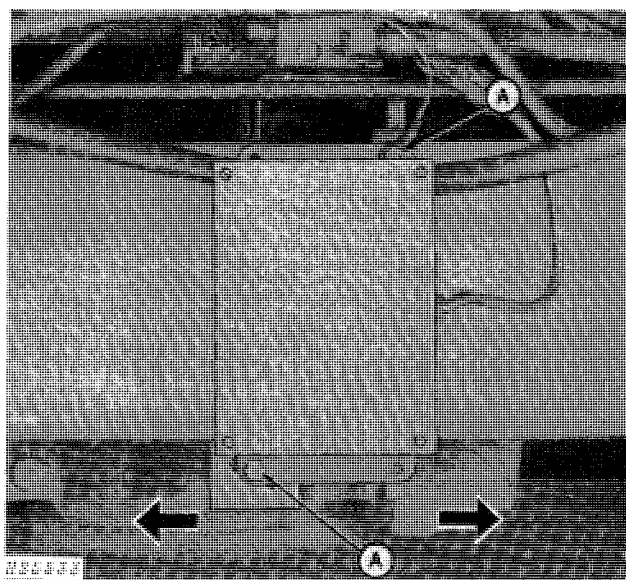



Fig. 45-Leveling Sensing Control Box

The control box keeps the separator level within one degree during field operation. If the separator consistently leans to one side, the control box is incorrectly positioned. See operator's manual.

## ENGINE OPERATING PROCEDURE

### Starting Engines

 **CAUTION:** Before starting the combine engine, be sure there is plenty of ventilation. Never operate the combine in a closed building.

1. Disengage header electromagnetic clutch switch, separator control lever, and grain tank unloading auger lever.
2. Place gearshift lever in neutral and set parking brake.
3. Depress clutch pedal fully or place the hydrostatic speed range lever in neutral.
4. Move throttle lever to slow idle position.
5. Be certain fuel shut-off knob is pushed all the way in.
6. Turn key clockwise to the first stop. Check that alternator indicator light glows red.
7. Turn key further clockwise and hold until engine starts. Release key immediately when engine starts.

**IMPORTANT:** When starting engine, never hold key in start position for more than 30 seconds. If engine does not start within 30 seconds, allow at least 2 minutes for proper cooling of starter. Be certain to pause a few seconds after a false start to be certain starter has stopped completely.

*NOTE:* If the prevailing temperature is 40°F (4°C) or lower, it may be necessary to use cold weather starting aid to start the engine.

To inject starting fluid, press starting aid button located on instrument panel (button marked with decal).

Stop injecting fluid after the engine starts. If the engine begins to die during the first few minutes of operation, inject another "shot" of fluid.

**IMPORTANT:** Fluid can must be left in tray, even if empty, to prevent dirt from being drawn into the engine. To avoid damage, turn engine with starter one or two revolutions before injecting starting fluid. Inject starting fluid only while the engine is turning.

**IMPORTANT:** Do NOT tow hydrostatic drive combines to start engine.

8. Make certain the oil pressure gauge registers pressure and the alternator indicator light goes off. If not, stop engine and determine the cause.

9. Idle the engine for several minutes to warm up engine and to insure turbocharger lubrication before accelerating, applying a load, or transporting.

10. Engage the separator and operate at 1500-1800 engine rpm for 5 to 10 minutes. Monitor oil pressure and water temperature and check for oil leaks.

11. If engine has not been operated for a long period of time, bleed entire fuel system to remove air bubbles.

### Stopping Engines

1. Place the hydrostatic speed range lever in neutral.
2. Place the gearshift lever in neutral.
3. Move the throttle lever to the rear. Allow the engine to idle a few minutes to cool the engine and turbocharger. (Lubrication and cooling of the turbocharger and some engine parts is provided by the engine lubricating oil. Therefore, sudden stopping of a hot engine may allow some parts to overheat and cause possible damage.) Allow the temperature gauge needle to drop well into the white range on the dial.
4. Pull out the fuel shut-off, and then turn the key off.

**IMPORTANT:** On combines with turbocharged 404 Engine, push fuel shut-off back in immediately after the engine has completely stopped, to prevent difficult restarting, in cold weather.

**IMPORTANT:** Do not attempt to stop engine by turning off fuel supply at tank.

## COMBINE RUN-IN

Place breaker bar in lugs of sheave on right-hand end of cylinder shaft and turn cylinder by hand to see that all shafts turn freely.

Be certain separator throw-out and grain tank unloading levers are disengaged, clutch is depressed, and transmission is in neutral position before starting engine. On hydrostatic drive combines, make certain that transmission and speed range levers are in neutral. As a safety measure, engage the parking brake lever.

Start engine and check engine oil pressure. It should read NORMAL (indicated by white zone on dial) at full governed speed.

Run separator with engine throttled down for a short period. Stop separator and engine and make a careful check for loose bolts, heating bearings, binding parts, and loose belts.

Start engine, engage separator and check combine basic speed at the primary countershaft. It should operate at 1500-1510 rpm (full throttle—no load). If not operating at proper speed, see engine service in operator's manual.

Check operation of the variable speed cylinder.

Check operation of the variable speed fan.

Check operation of the low shaft speed monitor system.

Walk around the combine and observe the operation of the moving parts. Watch for any signs of faulty operation and listen for slipping clutches or any other unusual sounds.

Check coolant temperature gauge to be sure it is operating properly. The white zone on the dial indicates normal operating temperature; the red-orange zone indicates above normal operating temperature. If the needle on the gauge goes into the red-orange zone, stop the engine and determine the cause.

During run-in, check the operation of all attachments and optional equipment that has been installed.

Check operation of all drive functions.

After combine has run 10 minutes at full speed operation, stop combine. **New belts will stretch slightly during run-in. Check and adjust belt tension.**

After run-in, check tension on elevator chains and adjust if necessary; close elevator doors.

Clean the combine and touch up places where the paint is nicked or scratched.

## TEMPORARY STORAGE

### All Combines

If the combine is to be stored outside after the assembly and run-in period, the following must be done to protect the combine and engine:

Condition engine as specified in End of Season Service Section of combine operator's manual. Also refer to storage information decal found in engine compartment.

A red tag is attached to the steering wheel stating that if the combine is to be placed in storage, specific battery gravity above 1.225 must be maintained.

Seal all engine and hydraulic system openings with sealing tape.

Release tension from V-belts, chains, and slip clutches.

Open the cleanout doors for the clean grain and tailings elevators, front door on the shoe grain supply augers housing, and the drain hole cover for the grain tank.

If combine is to remain idle for 60 days or more, jack up the combine to take the load off the tires.

### SideHill 6600 Combine

1. Lower header to ground, place transmission in neutral and release parking brake.

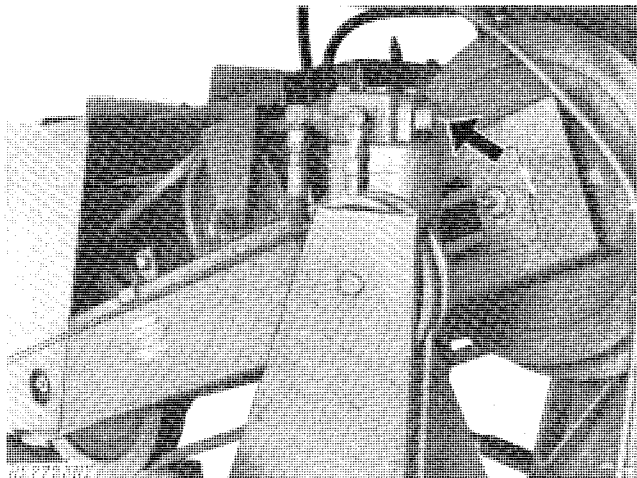

FIG. 46-Bleed Screw

**IMPORTANT:** To prevent possible damage to the wall of a building, open bleed screw on the cylinder farthest away from the wall. A 6-inch (152 mm) clearance between the end of the header and other objects must be maintained as the header will move when the cylinders are retracted.

2. Open bleed screw (Fig. 46) approximately 1/2 turn with a 3/8-inch open end wrench. Use a suitable container to catch oil flowing out of bleed screw. Approximately one quart of hydraulic oil will bleed out of each cylinder. It will take approximately two minutes for each leveling cylinder to retract. Oil will stop flowing automatically from the bleed screw, when the cylinder is fully retracted. To eliminate possible contamination of the hydraulic system, discard oil bled from cylinders and do not attempt to reuse.

**CAUTION:** Wear suitable eye protection, preferably goggles, when opening bleed screw.

3. Repeat Step 2 for the other leveling cylinder. Tighten bleed screw in each cylinder after bleeding.

4. Replace the same amount of oil bled from the cylinders by adding new oil of the proper viscosity to the hydraulic reservoir. This added oil will replace the oil bled from the cylinders during rephasing.

5. Wire the slack leveling cables away from cable sheaves to prevent damage.

**NOTE:** The SideHill 6600 combine may be moved a short distance if necessary, without rephasing the leveling cylinders.

## 200 SERIES CUTTING PLATFORMS PREDELIVERY

### UNLOADING PLATFORM, INSTALLING SKID PLATES, ROLLING PLATFORM OVER TO OPERATING POSITION, AND REMOVING SHIPPING SKID

1. (Not Illustrated) Use a fork truck or tractor with adequate lift and load capacity and with forks at least 5 ft. (1.5 m) long to unload platform from truck or rail car. Place forks under shipping skid when unloading the platform. Do not use chains attached to the shipping plates.

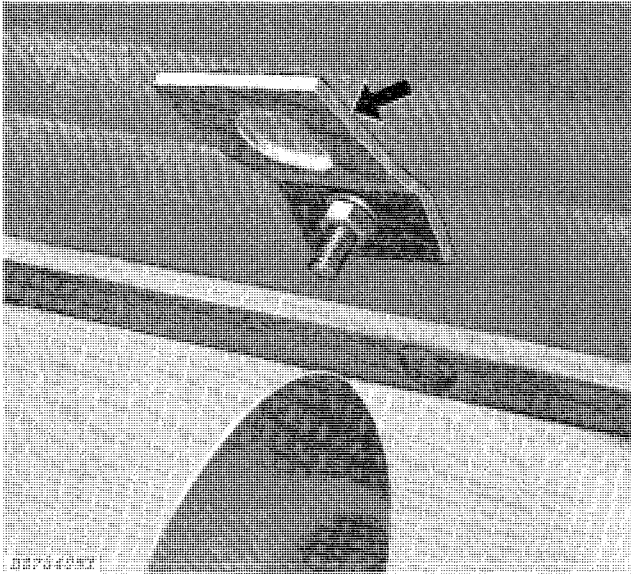

Fig. 47-Flex Platform Shipping Plate

Shipping plates are attached to the flex platform floor in front of the auger (Fig. 47).

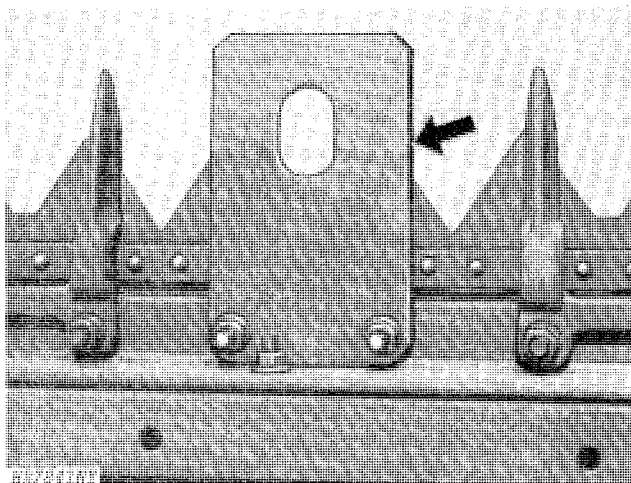

Fig. 48-Rigid Platform Shipping Plate

Shipping plates are attached to the rigid cutterbar in place of two knife guards (Fig. 48).

**IMPORTANT:** The shipping plates are intended only for use in rolling over the platform to the operating position. The cutterbar will be bent if the shipping plates are improperly used to move and/or unload the platform.

**CAUTION:** The weight of the platform rests on the three shipping skid uprights. Do not remove these uprights or their attaching bolts until the platform has been rolled over to the operating position.

2. (Rigid Platforms Only) While the rigid platform is still attached to the shipping skid in the upright position, install optional skid plates as follows:

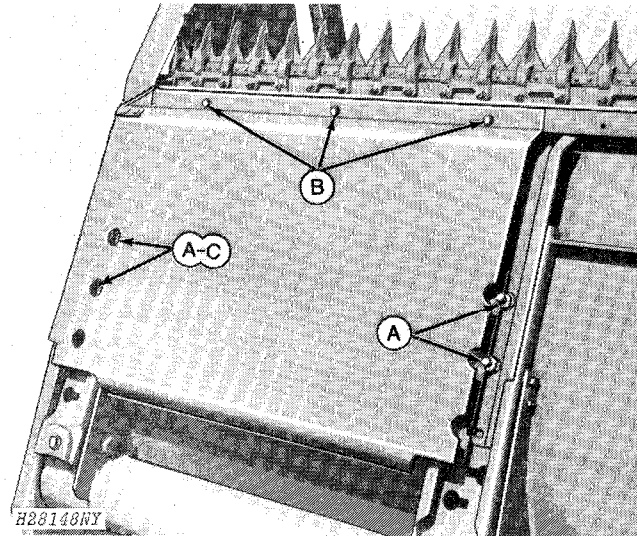

Fig. 49-Installing Skid Plates

A. Starting on the right-hand end of the platform, remove the two self-locking nuts on the round head bolts in each support arm (Fig. 49).

B. Position skid plate over the round head bolts in the sill (Fig. 49). Attach skid plate to sill with three 3/8 x 1-inch self-tapping screws. Insert a drift in the center hole to hold skid plate in position while starting two of the self-tapping screws.

C. Replace only those two self-locking nuts, removed in Step A, on the two round head bolts in the outer support arm (Fig. 49). The other two self-locking nuts will be replaced when the next skid plate is installed. These two self-locking nuts will then overlap both skid plates, holding them in place.

D. (Not Illustrated) Repeat Steps A, B, and C to install the other skid plates.

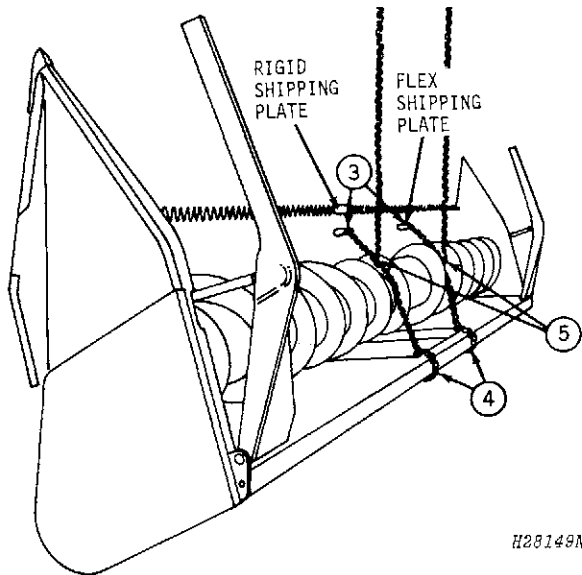

Fig. 50-Rolling Over Platform to Operating Position

3. Hook a suitable chain to each shipping plate (Fig. 50). Refer to Figs. 47 and 48 for location of the shipping plates.

4. Route chains over auger and secure each chain to platform top beam (Fig. 50).

5. Lay two 2 x 4's on the ground in front of the platform. Attach lift hooks to the chains, attached in Steps 3 and 4 (Fig. 50), and lower platform down on the 2 x 4's into the operating position.

**CAUTION:** Operate the controls of the hoist or lifting device slowly and with care.

Lower platform slowly down on the 2 x 4's, making certain chains stay clear of auger flighting and cutter-bar to eliminate possible damage.

6. (Not Illustrated) Remove chains and shipping plates from platform. Discard shipping plates. On flex platforms, replace shipping plate bolts in platform floor. On rigid platforms, install knife guards.

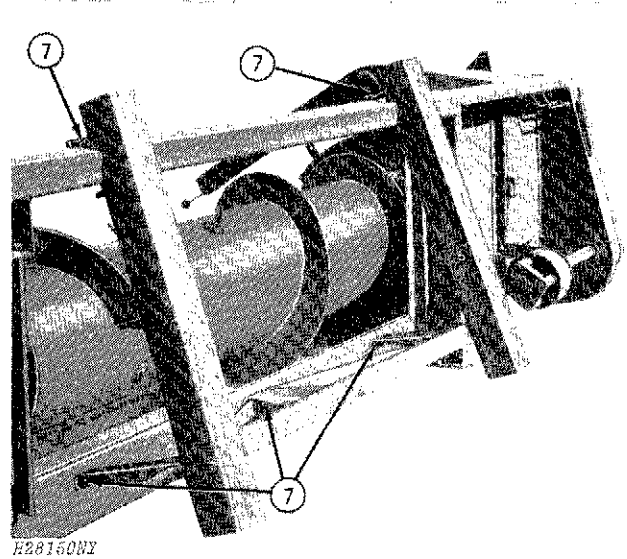

Fig. 51-Removing Shipping Skid

7. Remove the two clamps and the three uprights from the platform, and remove skid (Fig. 51). Discard clamps, uprights, and skid.

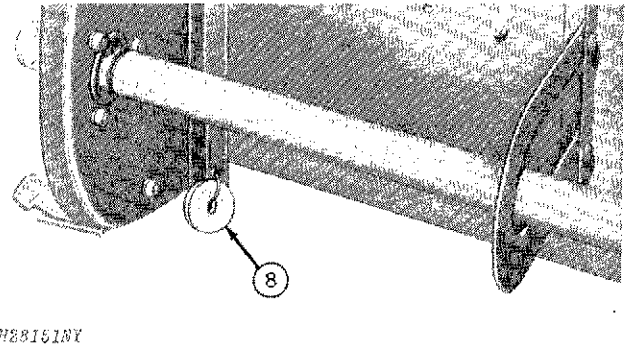

Fig. 52-Platform-to-Feeder House Washers

8. Remove the 21/32 x 2 x .250-inch flat washers wired to the lower rear part of the platform (Fig. 52). These washers are used with the 5/8 x 1-1/2-inch cap screws, required to secure the platform to the feeder house.

9. (Not Illustrated) Cut the bands securing hydraulic hoses and hose clamps to the platform top beam. Lay clamps aside for future installation on left-hand side of feeder house.

## INSTALLING CUTTERBAR DRIVE CASE BREATHER AND CUTTERBAR DRIVE SHEAVE

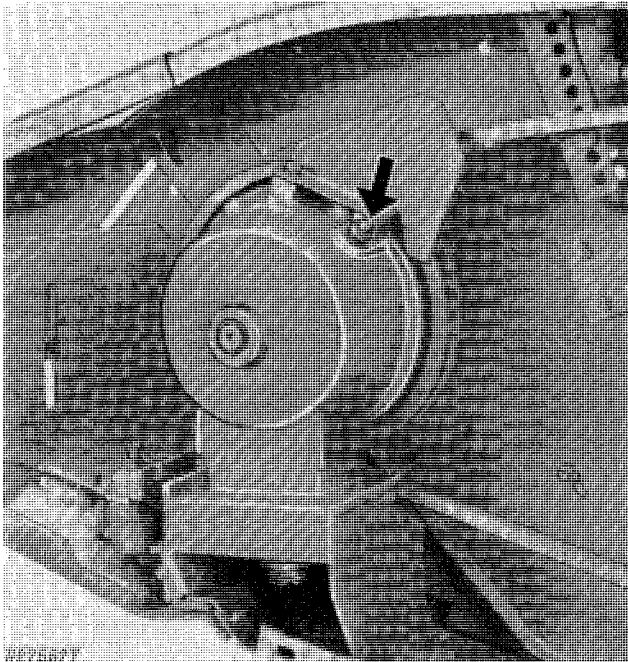
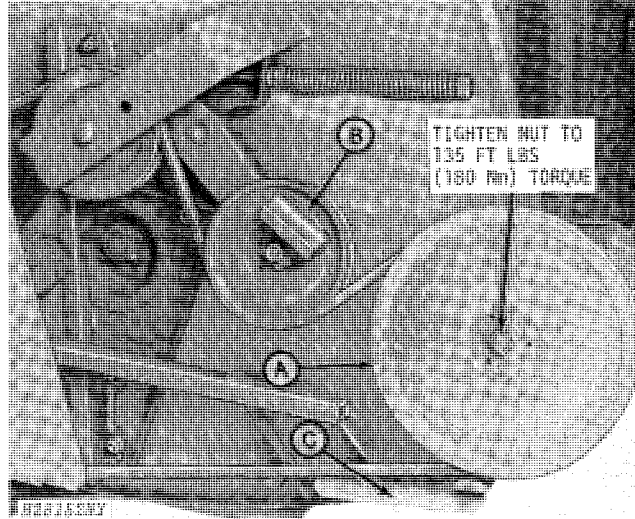

Fig. 53-Installing Breather in  
Cutterbar Drive Case

10. Cut wire attaching breather to cutterbar drive case. Remove and discard pipe plug from top of case and install breather (Fig. 53).



A—Cutterbar Drive Sheave  
B—Belt Tightener  
C—Shield Attaching Bracket

Fig. 54-Installing Cutterbar Drive Sheave

11. Cut wire and remove cutterbar drive sheave from left-hand end of platform. Remove nut, washer, and tape from end of shaft.

Place sheave (A) on shaft and secure with washer and nut (Fig. 54). Tighten nut to 135 ft-lbs (180 Nm) torque.

Pull belt tightener (B) up and place belt on sheaves (Fig. 54).

Check to be certain shield attaching bracket (C) under sheave does not rub on belt or sheave (Fig. 54).

## PICKUP REEL

Instructions for the assembly of the pickup reel are included with it.

## SLAT REEL

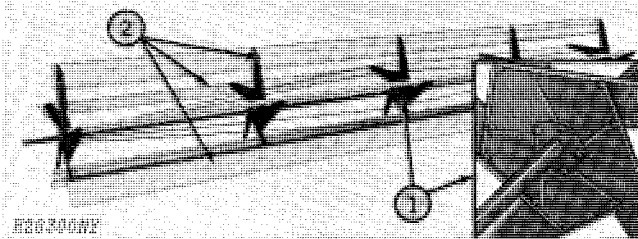

Fig. 56-Assembly of Metal Slat Reel

1. Assemble arms and attach arms to reel shaft with 3/8 x 3/4-inch cap screws (Fig. 56).
2. Attach metal reel slats to arms with 1/4 x 5/8-inch truss head machine screws (Fig. 56).

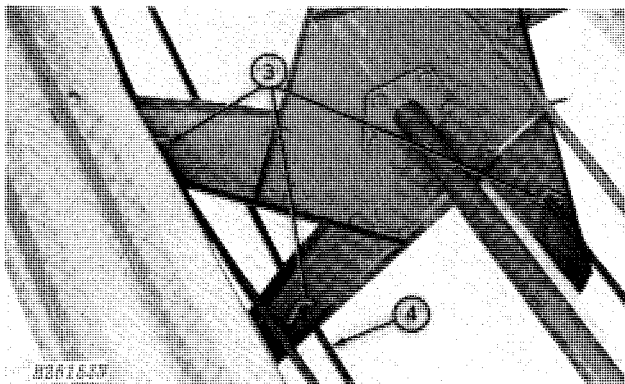

Fig. 57-Attaching Truss Rod Supports

3. (20-, 22-, and 24-ft. Reels). On 20-foot reels, attach five rod supports to the center set of reel arms. On 22- and 24-foot reels, attach ten rod supports to the two center sets of reel arms (Fig. 57). Use 5/16 x 5/8-inch cap screws to attach rod supports.
4. (20-, 22-, and 24-ft. Reels) Install truss rods through reel arms (Fig. 3).

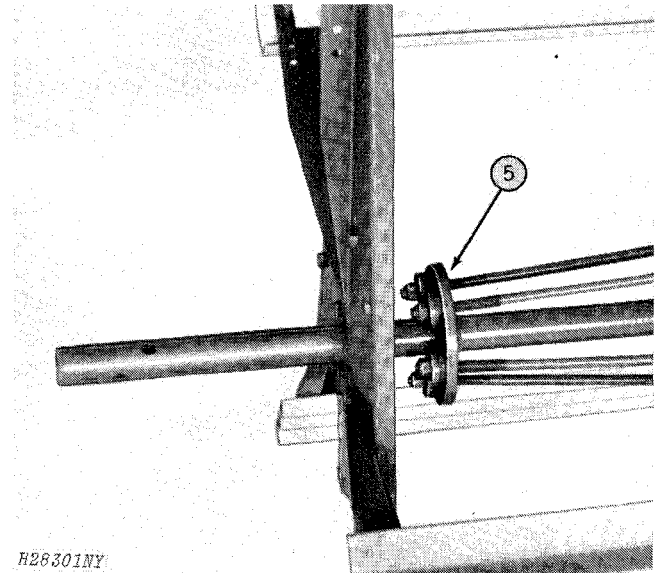

Fig. 58-Attaching Truss Rods

5. (20-, 22-, and 24-ft. Reels) Install a rubber washer, 13/32 x 1-1/4 x .194-inch washer, and 3/8-inch lock nut on both ends of truss rods (Fig. 58).

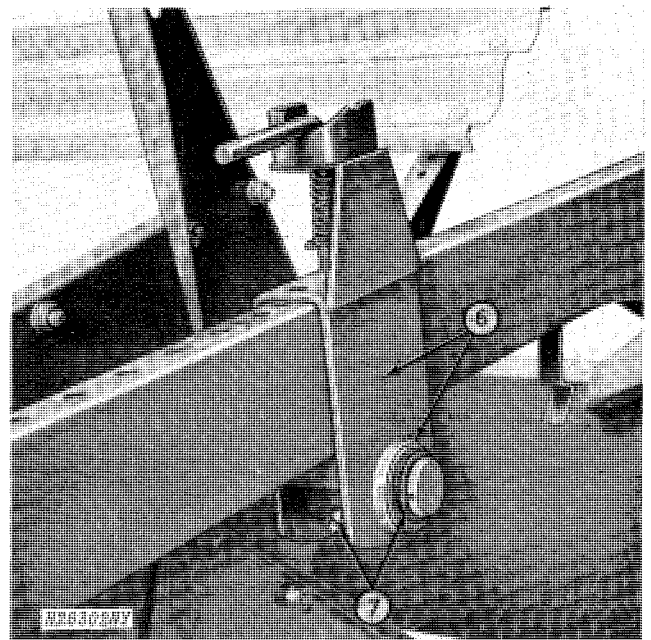

Fig. 59-Left-Hand Support Bracket

6. Slide left-hand reel support bracket on reel shaft (Fig. 59). Place 1-15/32 x 2 x .105-inch flat washer on each side of the support bracket.
7. Secure support bracket to reel shaft with snap ring (Fig. 59) and install grease fitting.

## INSTALLING REEL WITH MOUNTINGS ON SUPPORT ARMS

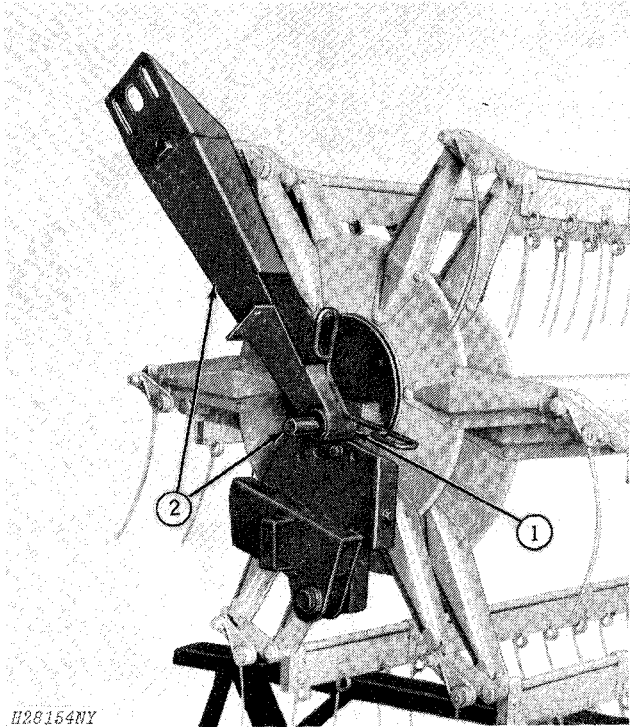

Fig. 60-Installing Right-Hand Reel Mounting  
(Pickup Reel Illustrated)

1. Place two 1-5/8 x 2-1/4 x .120-inch flat washers on reel shaft (Fig. 60).
2. Slide right-hand reel mounting on reel shaft (Fig. 60).

**CAUTION:** An assembled reel and mountings are heavy. Use suitable lifting capabilities when sliding the reel and mountings on the support arms.

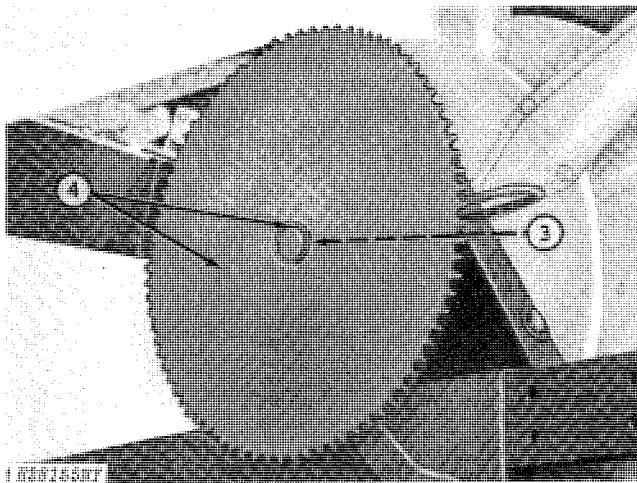
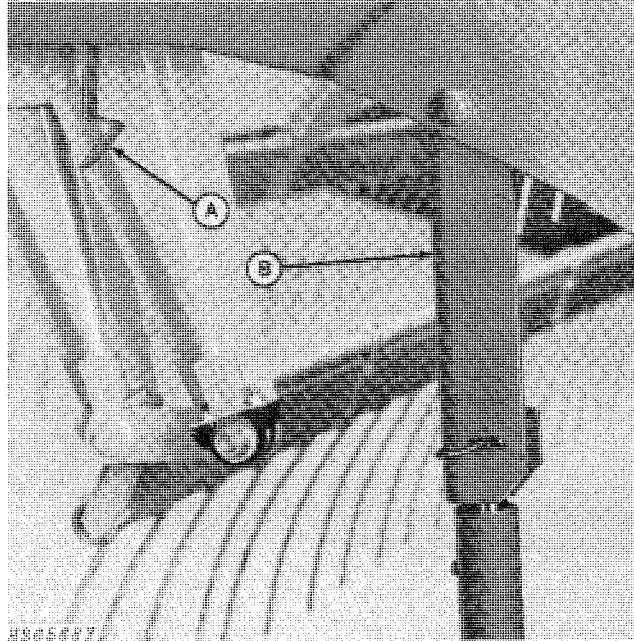

Fig. 61-Installing Reel Drive Sprocket

3. Place a 1-15/32 x 2 x .105-inch flat washer on reel shaft, next to reel mounting (Fig. 61).

4. Slide driven reel sprocket with a 3/8 x 2-1/8-inch Woodruff key on reel shaft (Fig. 60). Align outer surface of sprocket with end of shaft then install and tighten two 3/8 x 7/8-inch square head set screws, with jam nuts, in the sprocket hub.



A—Storage Catch

B—Safety Stop

Safety Position

Fig. 62-Lowering Reel Lift Safety Stops

5. Lift each reel support arm and lower the safety stop (Fig. 62). Push stop firmly against cylinder piston rod to be certain it is correctly positioned.

6. Using a suitable lifting device, slide assembled reel on the reel support arms. Slide reel evenly to the desired position on the arms.

## INSTALLING REEL DRIVE MOTOR, CHAIN DRIVE, SHIELD, CLAMPS, AND HOSES

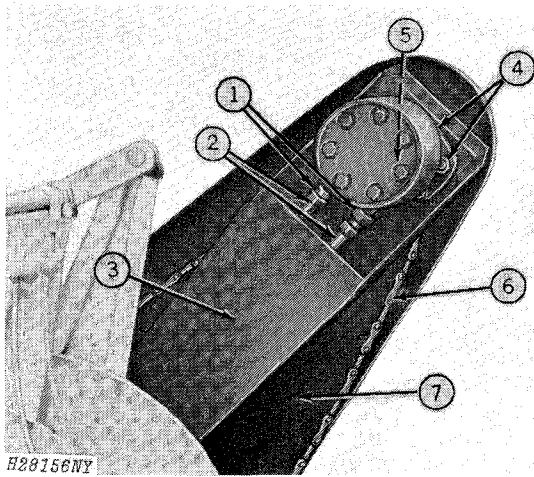

Fig. 63-Attaching Reel Drive Motor

1. Place an O-ring on each of two hose connectors and install connectors in reel motor (Fig. 63).

2. (Pickup Reel) Connect the two 13 ft. (4 m) hoses to the connectors in the reel motor (Fig. 63).

(Bat Reel) Connect the two short hoses to the connectors in the reel motor (Fig. 63).

3. Route reel drive motor hoses through mounting (Fig. 63).

4. Place steel shim between reel drive motor and mounting. Attach motor to mounting with four 1/2 x 1-1/2-inch round head bolts, lock washers, and nuts (Fig. 63). Do not tighten nuts.

5. Slide reel drive sprocket, with a 1/4 x 1-inch Woodruff key, on motor shaft (Fig. 63). Install and tighten two 5/16 x 3/4-inch square head set screws, with jam nuts, in the sprocket hub.

6. Place reel drive chain on sprockets (Fig. 63) and connect chain. Slide the reel drive motor back to tighten chain and then tighten the nuts on the four round head bolts.

7. Slide tab on reel drive shield (Fig. 63) into bracket on mounting. Attach lower end of shield to mounting with two 5/16 x 5/8-inch round head bolts and self-locking nuts.

(Bat Reel) (Not Illustrated) Connect the two long hoses to the two short hoses installed in Step 2.

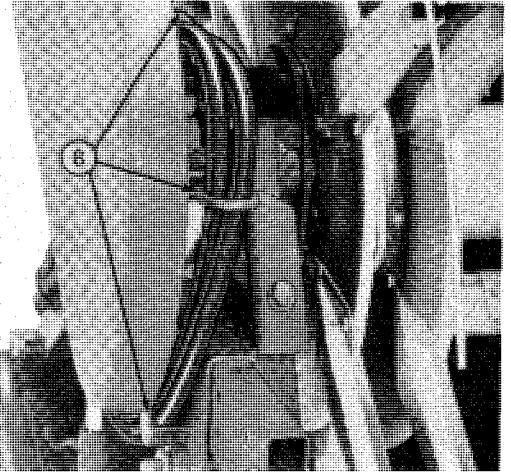

Fig. 64-Routing Reel Drive Hoses

8. Route both reel drive hoses through all three loops on the mounting (Fig. 64). Be certain hoses are straight and are not kinked.

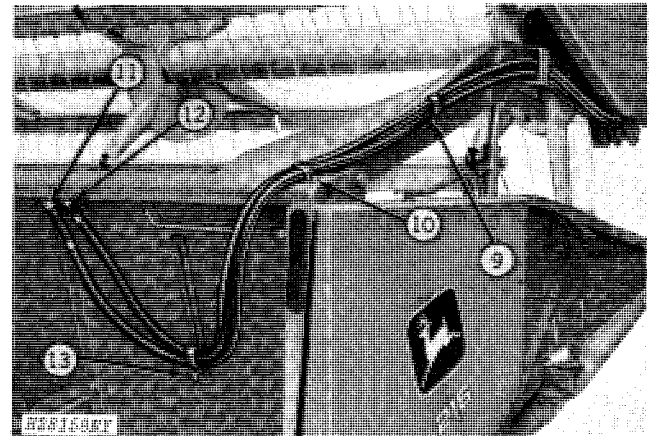

Fig. 65-Attaching Hose Clamps

9. Slip one hose clamp over both hoses and attach clamp to reel support arm with a 5/16 x 1-inch cap screw and lock nut (Fig. 65). Be certain clamp is positioned up as shown.

10. Slip the other hose clamp over both hoses and attach clamp to top of reel arm with a 5/16 x 3/4-inch cap screw and lock nut (Fig. 65). Be certain clamp is positioned as shown.

11. Connect hose from top port in reel drive motor to the shorter (inner) hydraulic line (Fig. 65).

12. Connect hose from bottom port in reel drive motor to the longer (outer) hydraulic line (Fig. 65).

**NOTE:** Reel drive hoses must be connected as described above or the reel will run backwards.

13. Remove wing nut from clamp on platform backsheet (Fig. 65), and slip clamp over both hoses. Replace wing nut on clamp. Slide clamp with hoses down and then tighten wing nut.

## INSTALLING RANGE INDICATOR (Flex Cutterbar Platforms)

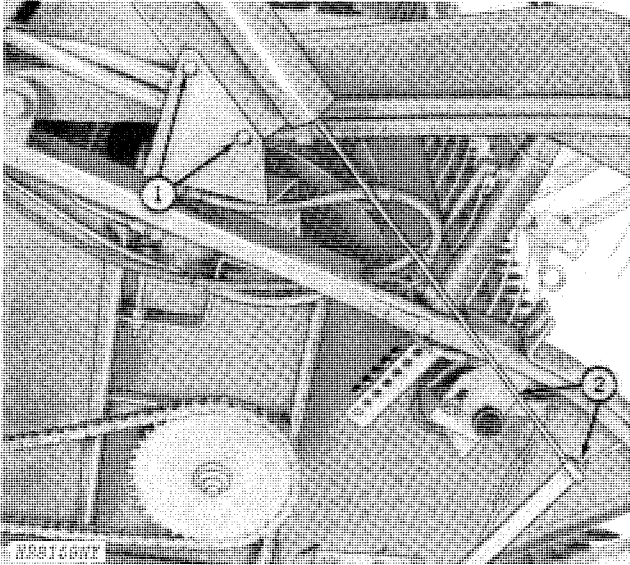

Fig. 66-Installing Range Indicator

1. Attach indicator housing to mounting bracket with two 5/16 x 3/4-inch round head bolts, flat washers, lock washers and nuts (Fig. 66).

2. Slide range indicator rod with ball attached into indicator housing (Fig. 66). Attach indicator rod to indicator arm with a 3/8-inch fine thread nut.

Refer to the operator's manual for 200 Series Cutting Platforms for adjustment of the range indicator.

## ATTACHING DIVIDER POINTS (Flex Cutterbar Platforms)



Fig. 67-Left-Hand Divider Point  
(Flex Cutterbar Platforms)

The following steps apply to both right-hand and left-hand divider points except as noted. Be certain to lower hydraulic cylinder safety stop when working on a raised platform.

**NOTE:** If platform is to be equipped with automatic header height control, install those parts before installing divider points.

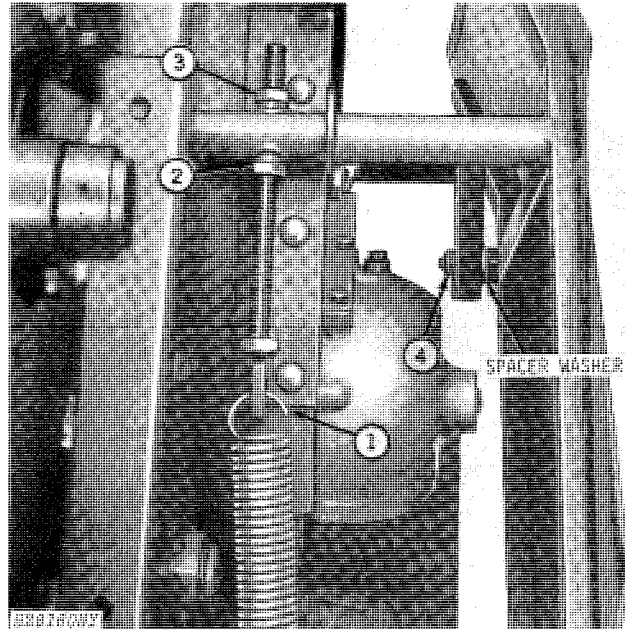

Fig. 68-Attaching Divider Point to Outside Bracket

1. Hook float spring to spring bracket (Fig. 68).

2. Thread 5/8-inch jam nut on approximately two-thirds the length of the 7-1/2-inch long stop bolt (Fig. 68).

3. Insert stop bolt through trunnion in divider point tube and secure with another 5/8-inch jam nut on the stop bolt (Fig. 68).

4. Attach divider point to outside support bracket with a 5/8 x 3-1/2-inch round head bolt, 21/32 x 1-9/16 x .180-inch flat washer, 11/16 x 1-1/2 x .134-inch flat washer, lock washer, and nut (Fig. 68).

**IMPORTANT:** The 21/32 x 1-9/16 x .180-inch flat washer serves as a spacer. Be certain to place it on the round head bolt between the divider point and the outside support bracket.

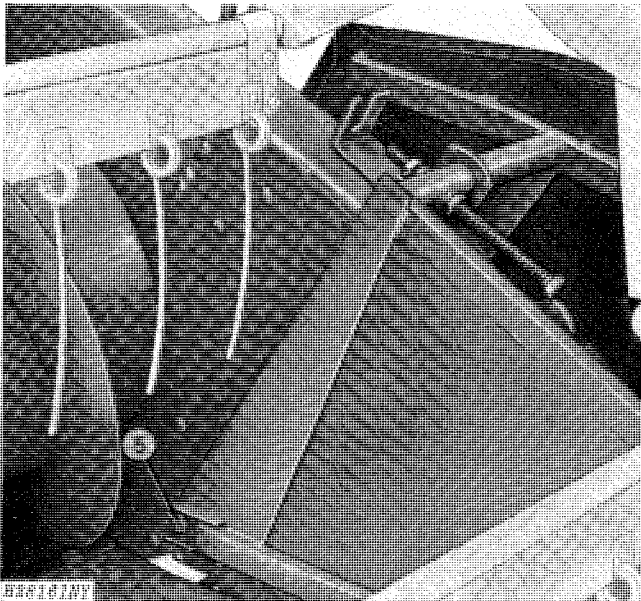

Fig. 69-Attaching Divider Point to Inside Bracket

5. Attach divider point to inside support bracket with a 5/8 x 2-1/2-inch cap screw, 21/32 x 1-1/2 x .120-inch flat washer, lock washer, and nut (Fig. 69).

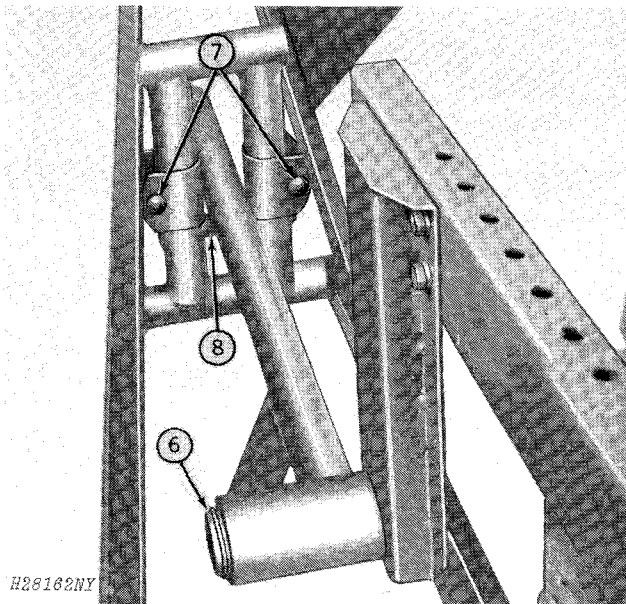

Fig. 70-Attaching Wear Plates

6. Coat shaft on outrigger bracket with multipurpose type grease. Secure outrigger assembly to outrigger bracket with snap ring (Fig. 70).

7. Attach two wear plates to each outrigger assembly with 5/16 x 2-1/2-inch round head bolts and self-locking nuts. Tighten self-locking nuts to 30 ft-lbs (40 Nm) torque (Fig. 70). Do not overtighten.

8. Hood outrigger assembly over tube in divider point (Fig. 70).

*Litho in U.S.A.*

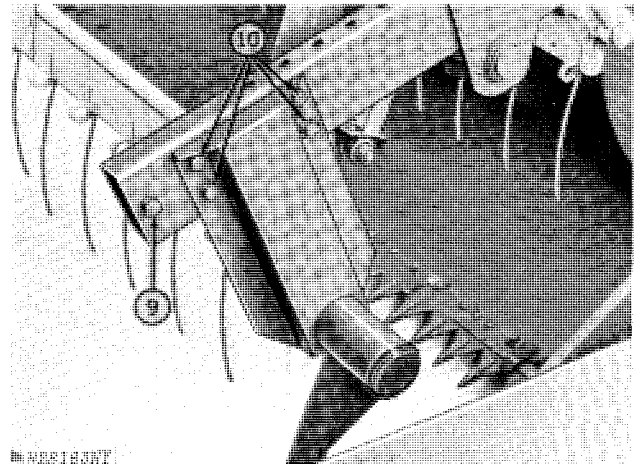

Fig. 71-Attaching Outrigger

9. Insert outrigger mounting plate in reel arm and secure to reel arm with one 3/8 x 1-inch cap screw and lock washer (Fig. 71). Do not tighten cap screw at this time.

10. Attach outrigger assembly to reel arm with four 3/8 x 1-inch cap screws and lock washers (Fig. 71). Tighten these four cap screws to 30 ft-lbs torque. Tighten cap screw installed in Step 9.

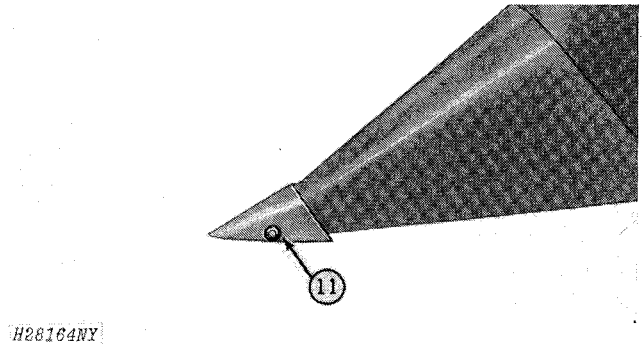

Fig. 72-Attaching Floating Shoes

11. Attach shoe assembly to end of divider point with a 5/8 x 2-5/8-inch cap screw, lock washer, and nut (Fig. 72). Push tip of shoe up and against divider point while tightening hardware.

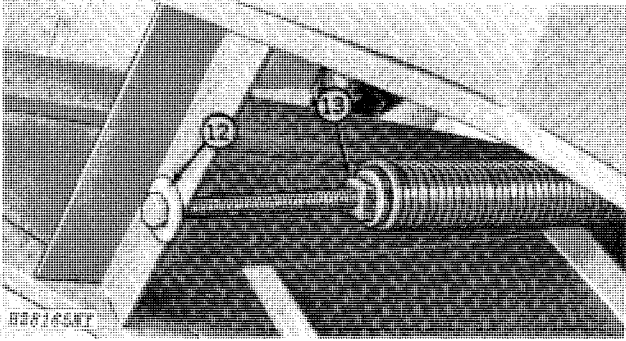
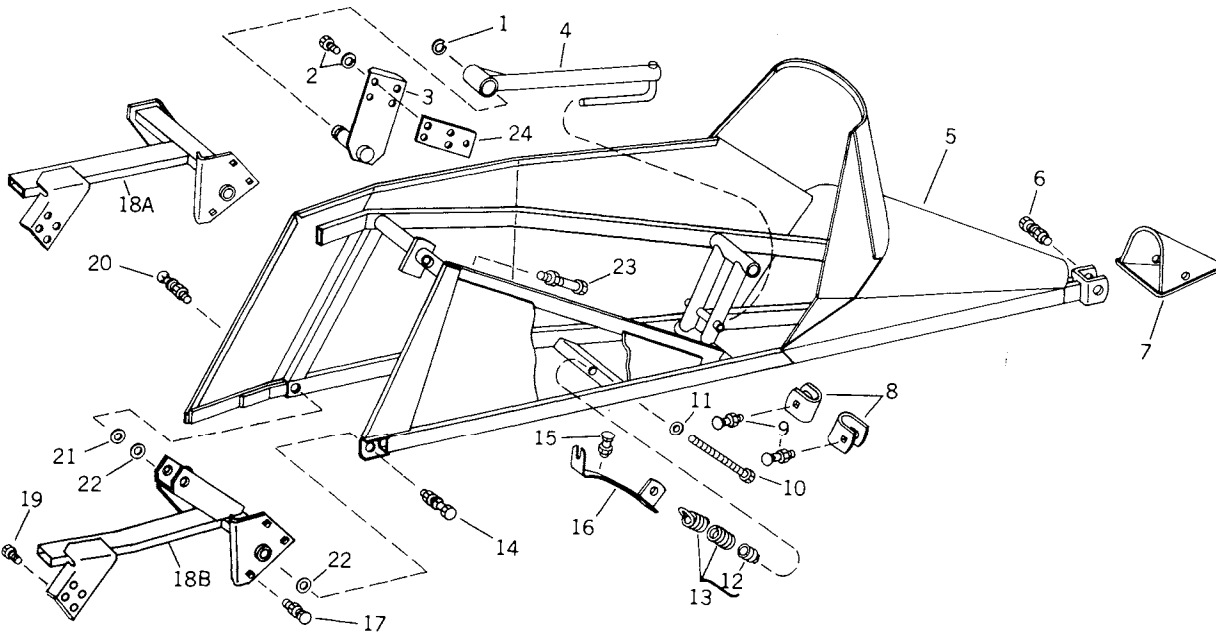

Fig. 73-Inserting Float Spring Bolt

12. Place a 17/32 x 1 x .120-inch flat washer on 8-1/2-inch long float spring bolt and insert bolt through hole in divider point brace (Fig. 73).

13. Turn spring bolt into spring plug (Fig. 73).

14. (Not Illustrated) Refer to 200 Series Cutting Platform Operator's Manual for correct adjustment of divider points.



H27907F

- |   |  |   |
|---|--|---|
| 1—Snap Ring                                   | 11—Washer, 17/32 x 1 x .120-inch   | 18—Mounting Bracket Assembly  |
| 2—Cap Screw, 3/8 x 1-inch (5 used)            | 12—Float Spring Plug   | 19—Self-Tapping Screw, 3/8 x 1-inch (3 used-R.H. Side) (4 used-L.H. Side) |
| 3—Outrigger Bracket                           | 13—Float Spring  | 20—Round Head Bolt, 5/8 x 3-1/2-inch                                      |
| 4—Outrigger Assembly                          | 14—Cap Screw, 5/8 x 2-1/2-inch   | 21—Washer, 21/32 x 1-9/16 x .180-inch                                     |
| 5—Divider Point                               | 15—Round Head Bolt, 3/8 x 1-inch (1 used-R.H. Side) (3 used-L.H. Side)   | 22—Washer, 11/16 x 1-1/2 x .134-inch (2 used)                             |
| 6—Cap Screw, 5/8 x 2-5/8-inch                 | 16—Spring Bracket  | 23—Stop Bolt, 5/8 x 7-1/2-inch  |
| 7—Shoe with Bushing                           | 17—Round Head Bolt, 3/8 x 3/4-inch (4 used-R.H. Side) (3 used-L.H. Side) | 24—Outrigger Mounting Plate   |
| 8—Wear Plate (2 used)                         |  |   |
| 9—Round Head Bolt, 5/16 x 2-1/2-inch (2 used) |  |   |
| 10—Float Spring Bolt 1/2 x 8-1/2-inch         |  |   |

Fig. 74-Exploded View of Left-Hand Floating Divider Point

## ATTACHING LOOP DIVIDERS (Rigid Cutterbar Platforms)

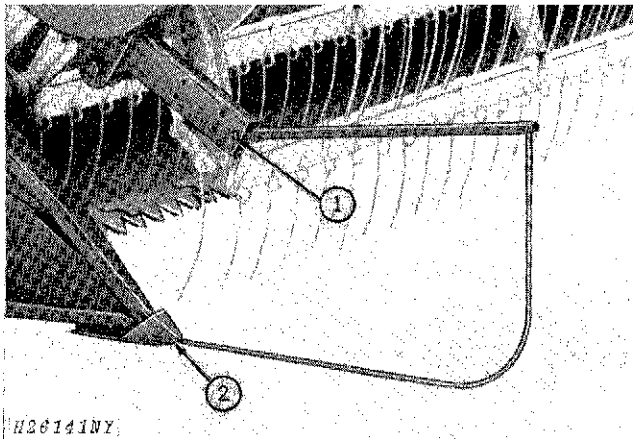
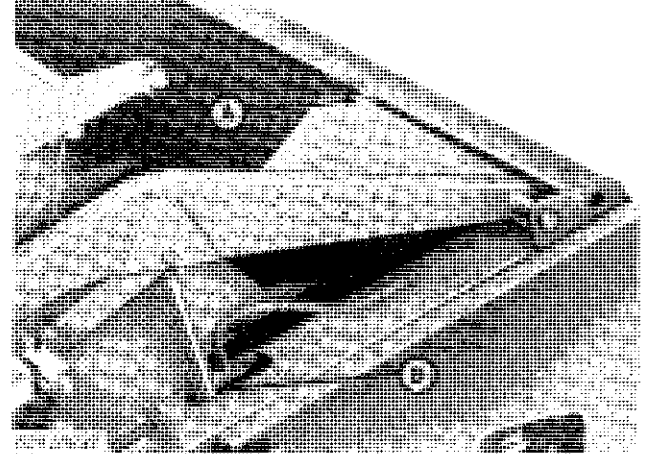

Fig. 75-Attaching Loop Dividers

1. Attach each divider to reel arm with one 3/8 x 2-inch cap screw (Fig. 75).
2. Attach divider to point with two 3/8 x 1-inch cap screws (Fig. 75).

## PREDELIVERY CHECKS

Check to be certain the platform is level and that the reel lift cylinders are adjusted to the correct position. Refer to the operator's manual for 200 Series Cutting Platforms for these procedures.



A—Slot in End Sheet

B—Cap Screw

Fig. 76-Positioning Reel Support Arms

Check position of reel support arms as follows,

1. Lower reel all the way down.
2. Loosen cap screw "A" (Fig. 76) on both ends of the platform and then tighten cap screws alternately to reposition reel support arms.
3. Check to be certain each reel lift cylinder does not bind in the slot in the top of the end sheet "B" (Fig. 76).
4. Raise and lower reel several times, again checking to be certain cylinders do not bind on the sides of the slots.

Check knife register. See 200 Series Cutting Platform operator's manual.

Check tension of auger drive chain. Chain should be just tight enough to run without climbing or jumping sprockets.

Refer to Group 15 of this section and completely lubricate the platform.

Make certain all bolts are tight and cotter pins are spread.

## MOUNTING CUTTING PLATFORM ON 6600 AND 7700 COMBINES

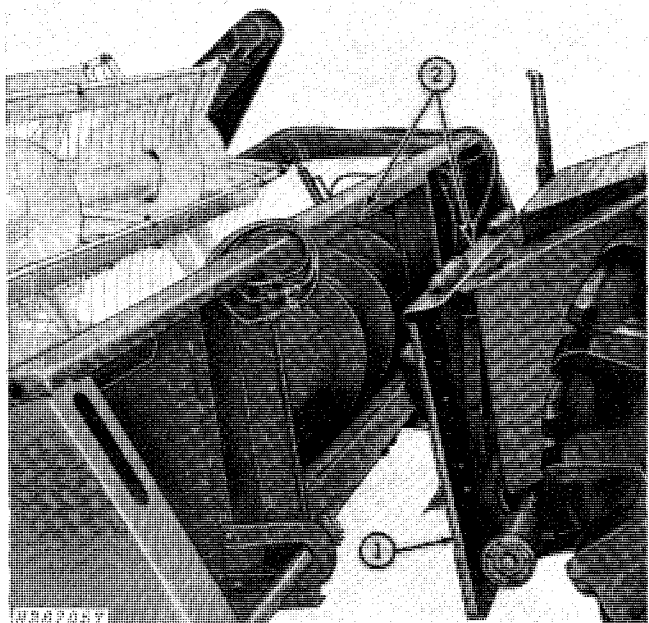

Fig. 77-Mounting Platform

1. Lower feeder house (Fig. 77).

*NOTE: The two bolts in the feeder house frame must be removed before mounting platform, to insure a tight seal.*

2. Drive combine forward until feeder house is in place (Fig. 70). Raise feeder house.

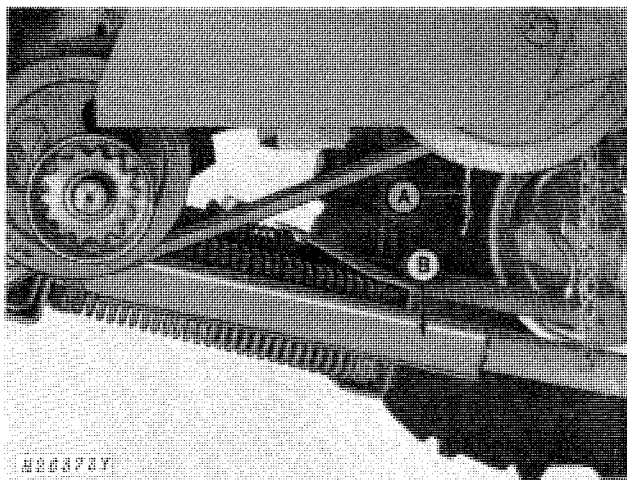

Fig. 78-Lowering Safety Stop

3. Disconnect chain "A" and lower hydraulic cylinder safety stop "B" on piston rod (Fig. 78).

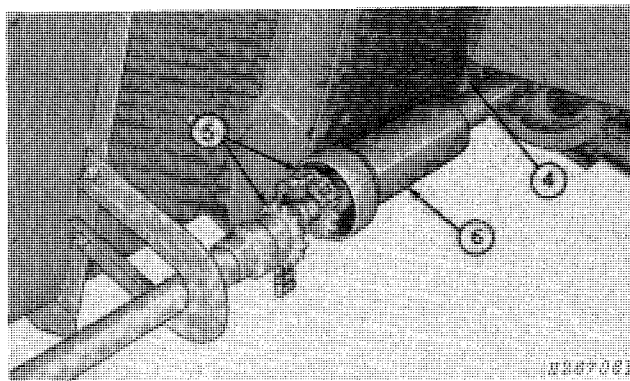

Fig. 79-Securing Platform  
(Left-Hand Drive Shaft Illustrated)

4. Secure platform to feeder house with two 5/8 x 1-1/2-inch cap screws, 21/32 x 2 x .250-inch washers and lock washers (Fig. 79).
5. Place roller chain around sprockets (both sides) (Fig. 79).
6. Slide coupler housing over sprockets and roller chain (both sides) (Fig. 79).
7. Raise hydraulic cylinder safety stop "B" and hook to chain "A." (Fig. 79).

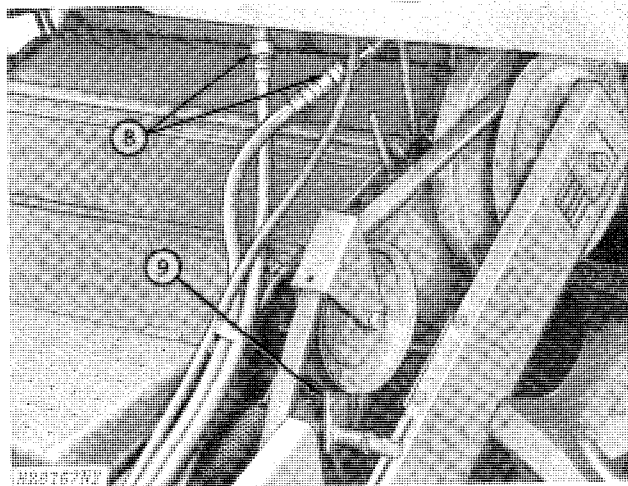

Fig. 80-Connecting and Routing Hoses

8. Connect hoses for hydraulic reel lift and hydrostatic reel drive at couplers under operator's platform (Fig. 80).
9. To prevent damage to variable speed feeder house hoses when they are disconnected, route hoses down between feeder house and variable-belt-drive and secure with clamps (Fig. 80). Do not connect hoses together.

*NOTE: After platform has been attached to the feeder house, check to be certain platform is level as shown in the platform operator's manual.*

## MOUNTING CUTTING PLATFORM ON SIDEHILL 6600 COMBINE

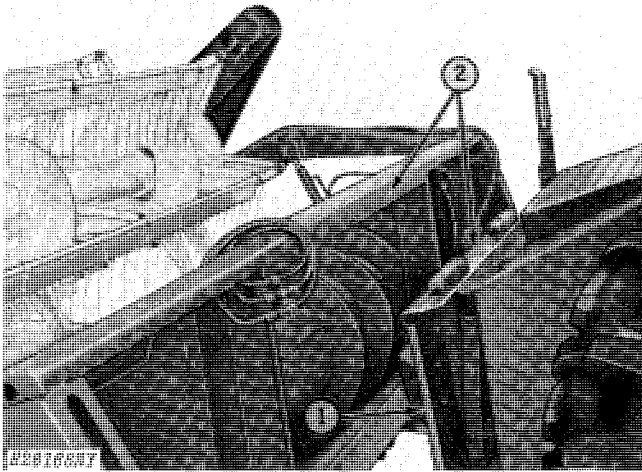

Fig. 81-Mounting Platform

1. Lower feeder house (Fig. 81).

**NOTE:** The two bolts in the feeder house frame must be removed before mounting platform, to insure a tight seal.

2. Drive combine forward until feeder house is in place (Fig. 81). Raise feeder house.

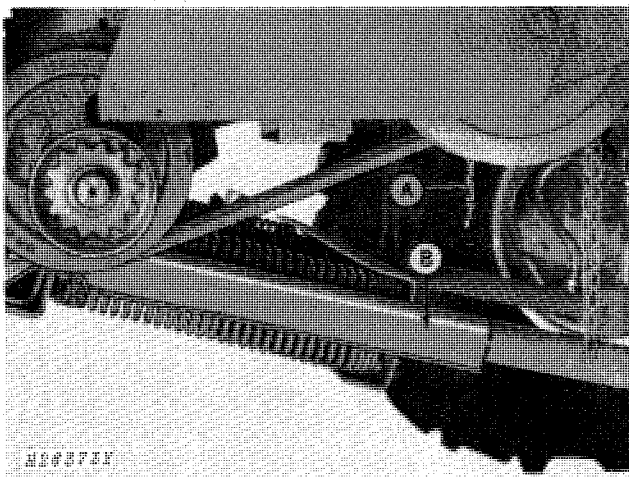

Fig. 82-Lowering Safety Stop

3. Disconnect chain "A" and lower hydraulic cylinder safety stop "B" on piston rod (Fig. 82).

4. Secure platform to feeder house with two 5/8 x 1-1/2-inch cap screws, 21/32 x 2 x .250-inch washers and lock washers.

Litho in U.S.A.

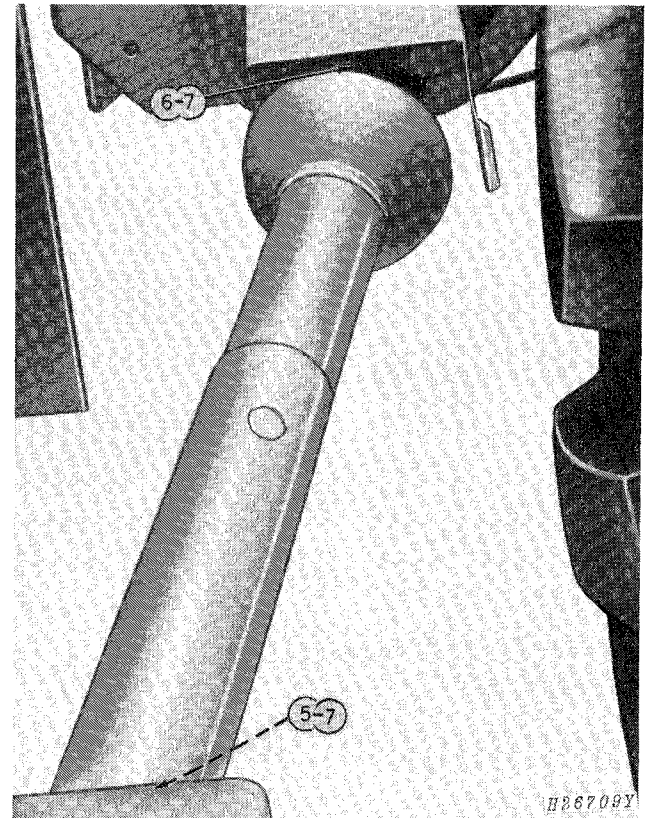

Fig. 83-Connecting Drive Shafts

5. Slide the hex. end of telescoping drive shaft on hex. shaft on the platform (Fig. 83).

6. Slide splined end of drive shaft on the splined feeder house shaft (Fig. 83).

7. Tighten clamp on each end of drive shaft (Fig. 83). Raise hydraulic cylinder safety stop "B" and hook to chain "A." (Fig. 82).

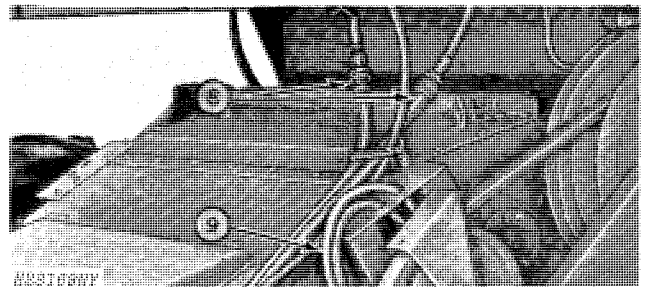

Fig. 84-Connecting and Routing Hoses

8. Connect hoses for reel lift and reel drive at couplers under operator's platform (Fig. 84).

9. To prevent damage to variable speed feeder house hoses when they are disconnected, route hoses down between feeder house and variable-belt-drive and secure with clamps (Fig. 84). Do not connect hoses together.

**NOTE:** After platform has been attached to the feeder house, check to be certain platform is level as shown in the platform operator's manual.

## 40 SERIES CORN HEADS PREDELIVERY

### REMOVING CORN HEAD FROM SHIPPING SKID

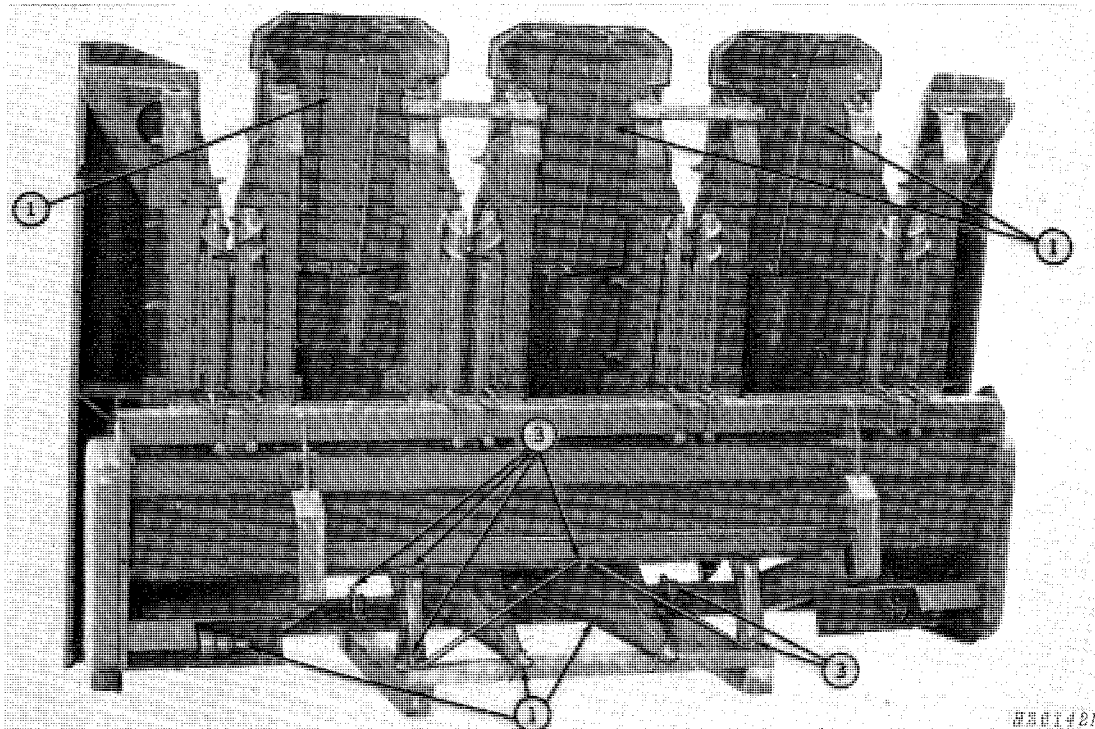

Fig. 85-Removing Gatherer Points and Parts

**CAUTION:** Be careful when unloading the corn head. If unloading with a fork truck, the fork must be at least 5 feet (1.5 m) long.

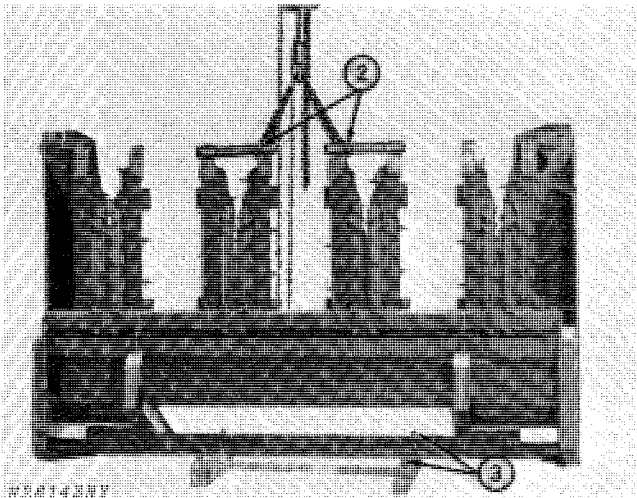

Fig. 86-Attaching Hoist to Corn Head

1. After corn head has been removed to area where it is to be assembled, remove center gatherer points and shields, and outer gatherer points (Fig. 85). Cut all wires and place parts out of way for later assembly.

*NOTE: The corn head is shipped with only one drive coupler. For 443, 444, 543, 546, 642, 643, 644, 645, 842, and 843 Corn Heads which require two drive couplers, use drive coupler shipped with feeder house.*

2. With the aid of an overhead hoist, attach a heavy lifting chain to the shipping channels (Fig. 86). Raise corn head just high enough so skid uprights and clamps can be removed.

**CAUTION:** Make certain that overhead hoist or lifting device used has adequate lift and load capacity before removing corn head from skid. Be certain to use an adequate lifting chain when removing corn head.

3. Remove clamps and uprights that attach corn head to skid (Fig. 85).

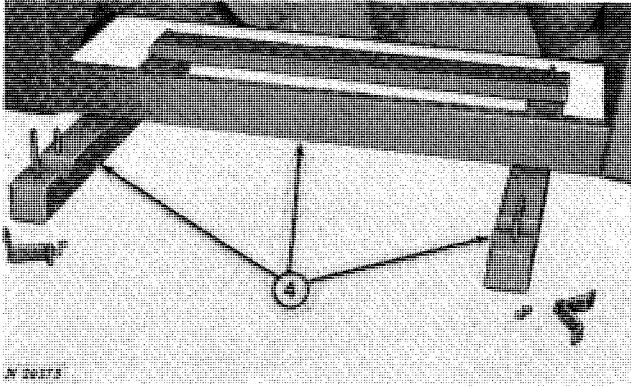

Fig. 87-Removing Shipping Skid

4. Position corn head skid under corn head frame about halfway between 4 x 4's (Fig. 87).

With corn head resting about halfway between 4 x 4's, slowly lower the corn head forward to ground.

Remove shipping channels and lift chains from corn head row units.

### INSTALLING WHEEL SHIELDS

To facilitate installation of wheel shields, first mount corn head on combine. See page 10-10-36.

### 344 Corn Head

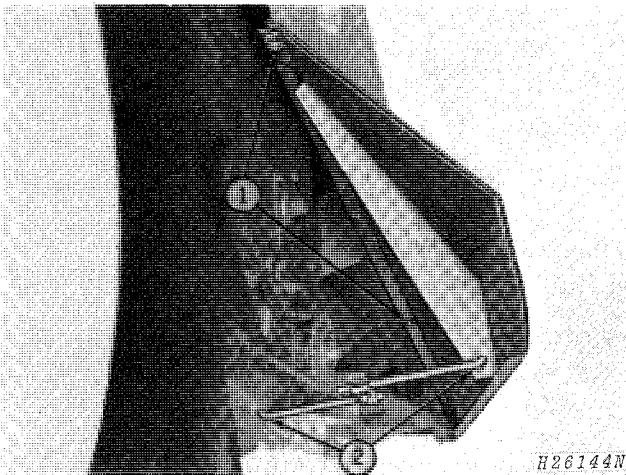

Fig. 88-Installing 344 Corn Head Wheel Shields

1. Bolt wheel shield to outer gatherer sheet with four 1/4 x 3/4-inch self tapping screws, 9/32 x 1 x .060-inch flat washers, and nuts (Fig. 88).

2. Insert offset end of shield support rod in corn head frame and other support rod in wheel shield. Loosen clamp on shield support rods and adjust shield for adequate drive wheel clearance (Fig. 88).

Litho in U.S.A.

### 642 and 842 Corn Heads

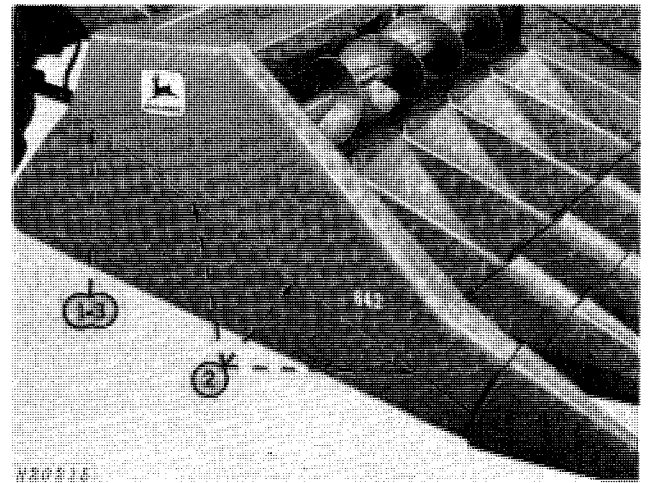
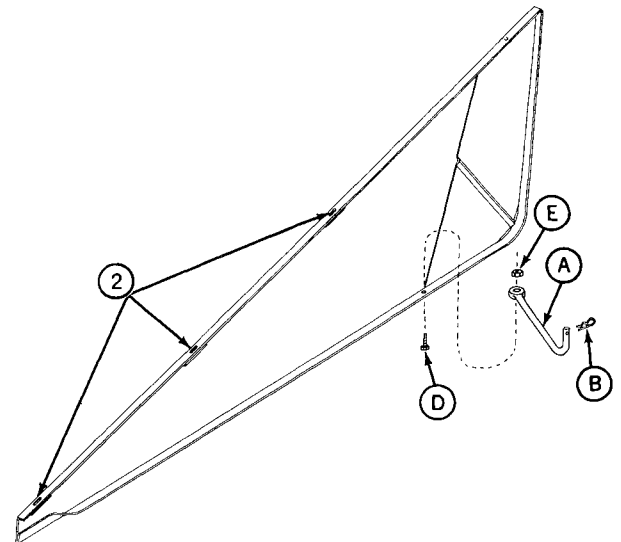

Fig. 89-Installing 642 and 842 Corn Head Wheel Shields

1. Remove the 1/4 x 3/4-inch self tapping screw in the rear of corn head (Fig. 89).

2. Lift shield so the three key-hole-slotted holes are fitted over the 1/8-inch pipe spacer. Slide shield forward until it is locked into place (Fig. 89).

3. Replace the 1/4 x 3/4-inch self tapping screw removed in Step 1 (Fig. 89).



H26145N

Fig. 90-Pinning Adjusting Rod

4. Remove adjusting rod "A," bolted to corn head frame (Fig. 90). Turn adjusting rod end for end and pin rod to frame with spring locking pin "B" in the hole that rod was previously bolted. Place eyebolt end of adjusting rod on top of flange at bottom of wheel shield, align 11/32-inch hole and attach with a 5/16 x 1-inch cap screw "D" and 5/16-inch self-locking nut "E."

## INSTALLING INNER AND OUTER GATHERER POINTS

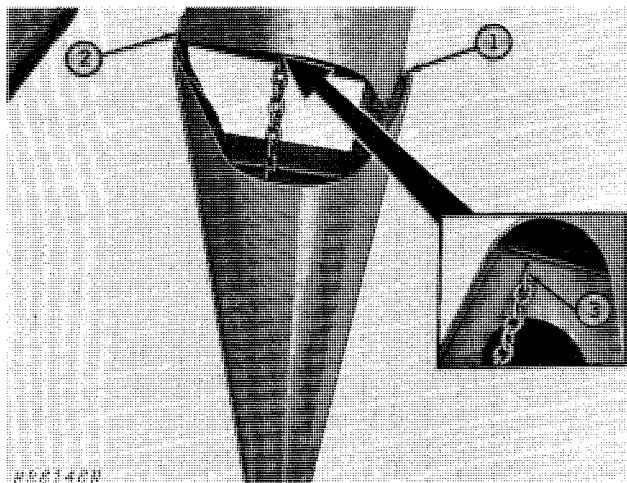

Fig. 91-Installing Outer Gatherer Point

1. Remove pivot assembly and insert bolts in the rear pair of holes on point. Insert pivot assembly in hinge hole on outer gatherer sheet (Fig. 91).

2. Bolt gatherer point to outer gatherer sheet with 716 x 1-1/2-inch round head bolt, spacer, 15/32 x 1-1/8-inch flat washer and nut (Fig. 91).

3. Push pivot pin through support and tighten pivot bolt assembly to point (Fig. 91).

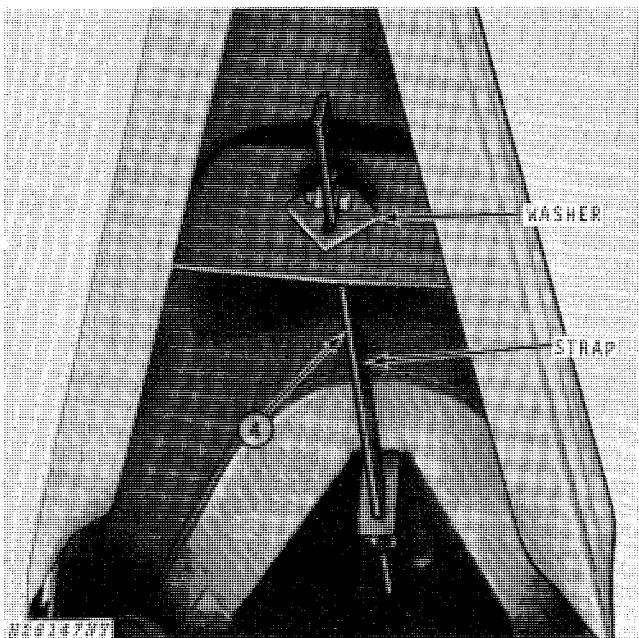

Fig. 92-Positioning Gatherer Point Height Strap

4. (642 and 842 Corn Heads Center Gatherer Only) Remove 3/4-inch cap screw from end of strap with 10 holes. Insert strap through slot in bulkhead (Fig. 92).

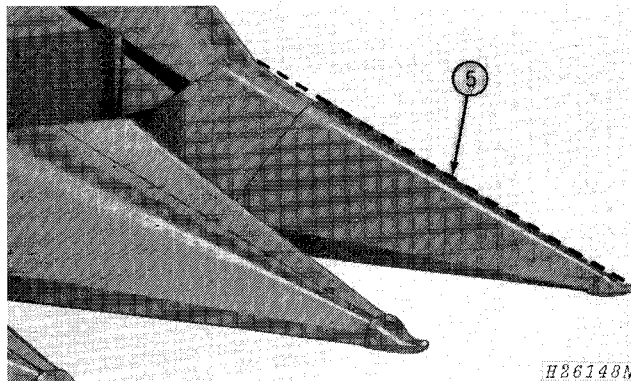
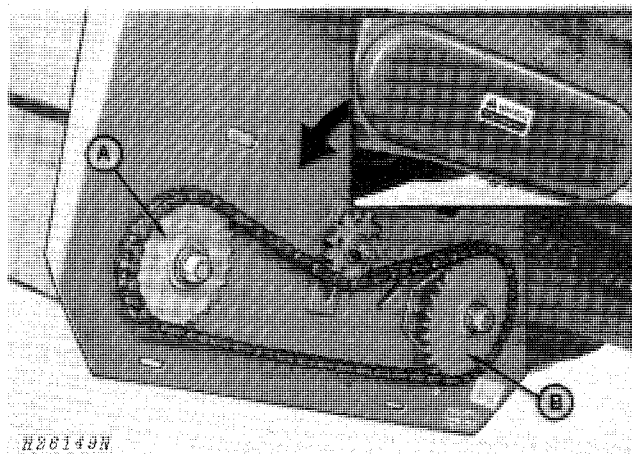

Fig. 93-Positioning Gatherer Point

5. Manually raise gatherer point so there is a straight line across gatherer sheet and gatherer point. Slip square slotted washer over strap and replace 3/4-inch cap screw (Fig. 93).



A—30-Tooth Sprocket

B—24-Tooth Sprocket

Fig. 94-Interchanging Row Unit Drive Shaft Sprockets

6. Loosen tightener sprocket, disconnect drive chain, and interchange the 30-tooth sprocket on row unit drive shaft with the 24-tooth sprocket on the transverse drive shaft—both sides (Fig. 94).

Reinstall drive chain and adjust chain tension with tightener sprocket.

On all corn heads except the 344, it will be necessary to remove the shield. To remove the shield, first remove shipping bolt and clip. Push down on top of shield until the shield springs out of the attaching slots. Reinstall shield after the chain is adjusted.

**NOTE:** The shipping bolt and clip do not have to be reinstalled. The bolt and clip were installed at the factory for shipping purposes only.

On the 344 Corn Head, it will only be necessary to swing wheel shield out of the way.

## INSTALLING CENTER GATHERER POINTS AND CENTER SHIELDS

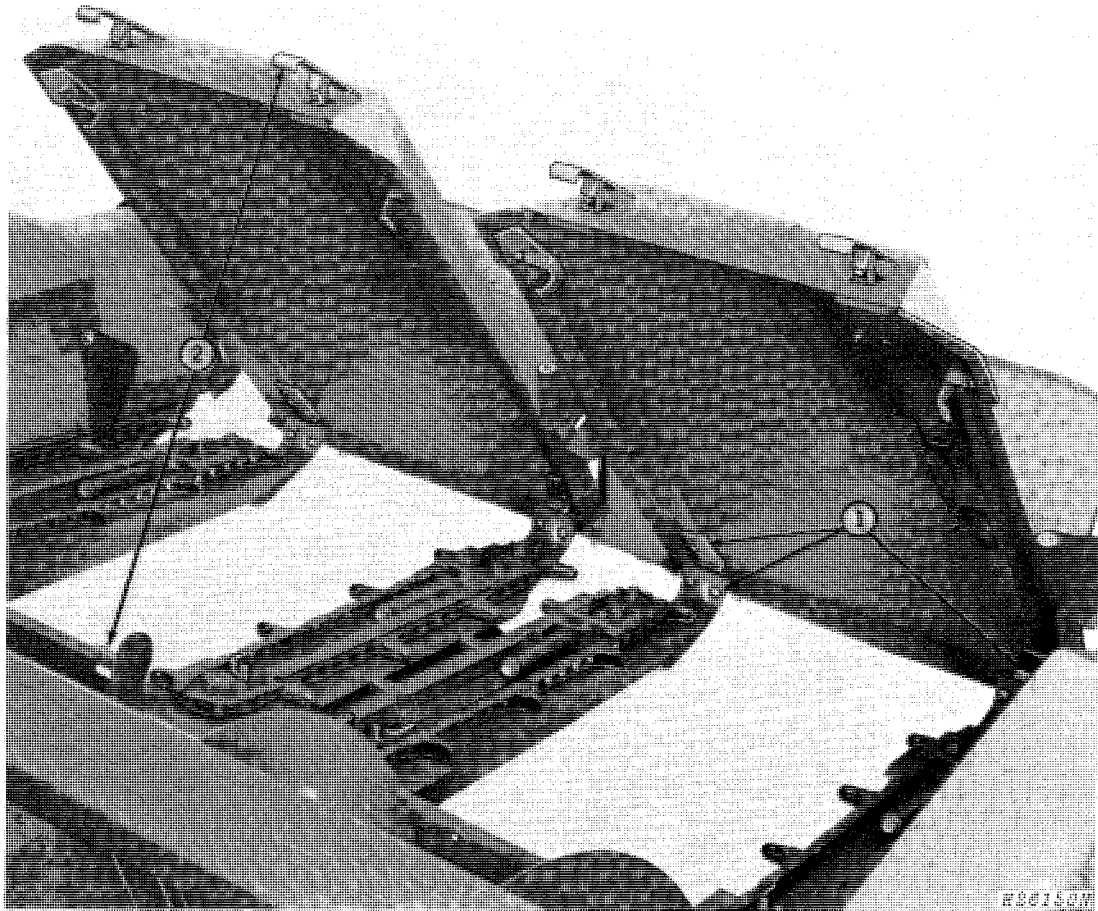

Fig. 95-Installing Center Gatherer Points and Center Shields

To facilitate installation of center gatherer points and center shields, first start combine engine and raise corn head as high as possible.



**CAUTION: Lower cylinder safety stop on combine.**

1. Insert center shield hinges into hinges on row units (Fig. 95).

2. Tip center shields down and attach center shield latches to attaching points (Fig. 95). Adjust latches if required.

## MOUNTING CORN HEAD ON COMBINE

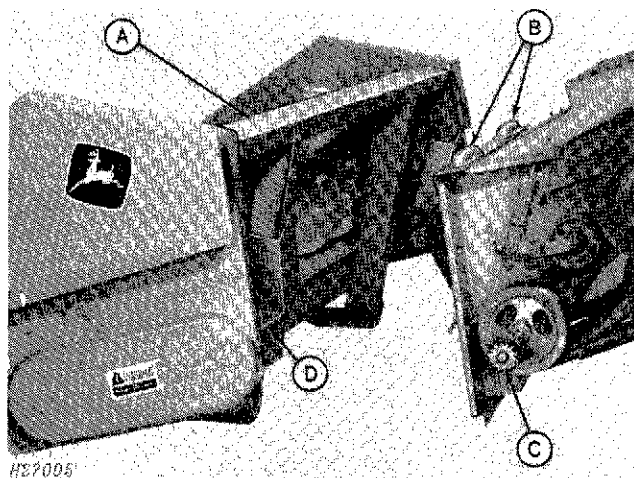

A—Main Frame Tube  
B—Attaching Blocks  
C—Coupler  
D—Coupler and Transverse Drive Shield

Fig. 96-Installing Coupler

1. Before mounting the corn head on the combine, install the coupler "C" (Fig. 96) on feeder house powershaft.

*NOTE: The corn head is shipped with one coupler. For 443, 444, 543, 546, 642, 643, 644, 645, 842, and 843 Corn Heads which require two drive couplers, use coupler shipped with feeder house.*

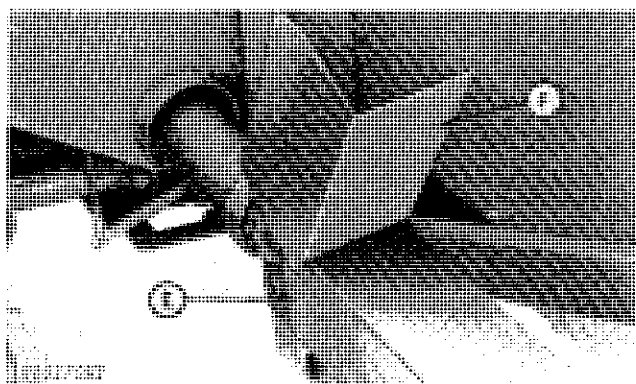

E—Bolt  
F—Shield

Fig. 97-Coupler and Transverse Shield  
(843 Corn Head Drive Illustrated)

2. On 443, 444, 543, 546, 642, 643, 644, 645, 842, and 843 Corn Heads, remove and discard bolt "E" from the coupler and transverse shields on both sides of the corn head and position shields "F" up (Fig. 97). This will prevent damage to the shields when the combine is driven forward.

3. Start the combine engine and lower the feeder house enough so the attaching blocks, "B" (Fig. 97), will pass under the corn head main frame tube "A".

4. Drive the combine forward until the attaching blocks are under the main frame tube and the feeder house is against the corn head frame. Using the height control lever on the combine, raise the feeder house and corn head as high as possible.

5. Shut the combine engine off and dismount combine.

**CAUTION:** Lower cylinder safety stop on combine before attempting to install attaching bolts, drive chain, or hooking up the couplers.

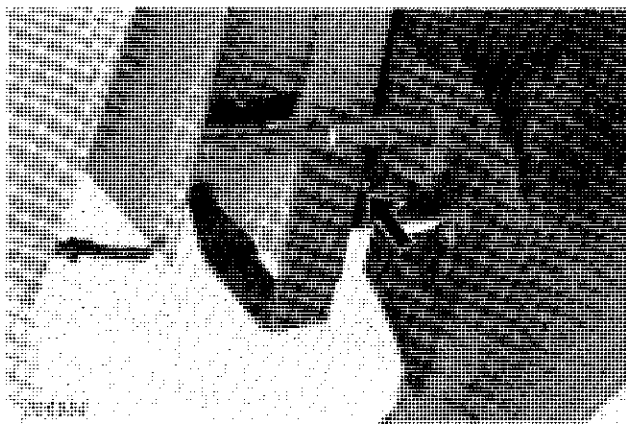
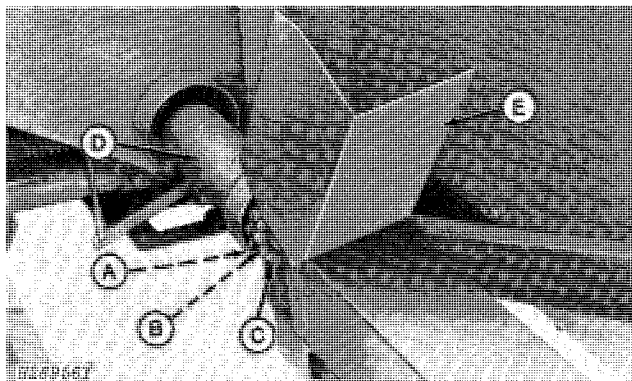

Fig. 98-Securing Corn Head and Feeder House Together

6. Secure the corn head and feeder house together with three 1/2 x 1-1/2-inch round head bolts (Fig. 98).

## ATTACHING CORN HEAD DRIVES FOR 6600 AND 7700 COMBINES



- |                             |                   |
|-----------------------------|-------------------|
| A—Coupler Sprocket          | C—Chain           |
| B—Transverse Drive Sprocket | D—Coupler Housing |
|                             | E—Drive Shield    |

Fig. 99-Attaching Corn Head Drives  
(843 Corn Head Right-Hand Drive Illustrated)

1. Slide the coupler sprocket "A" against the transverse drive sprocket "B" with the teeth on the sprockets positioned directly across from one another (Fig. 99).
2. Install chain "C" around sprockets (Fig. 99).
3. Slide the coupler housing "D" back and let it snap over the sprockets and chain. The coupler housing encloses the sprockets and chain together (Fig. 99).
4. On 443, 444, 543, 546, 642, 643, 644, 645, 842, and 843 Corn Heads, lower the coupler and transverse drive shields "E" on both sides of the corn head.
5. Hook up the cylinder safety stop on combine and lower the corn head to the ground.

**⚠ CAUTION: When machine is operating, make certain no one is standing near enough to combine or corn head to touch any moving parts.**

## ATTACHING CORN HEAD DRIVES FOR SIDEHILL 6600 COMBINE

1. Secure the corn head and feeder house together with three 1/2 x 1-1/2-inch round head bolts. One bolt is in the corn head and two are in the feeder house.

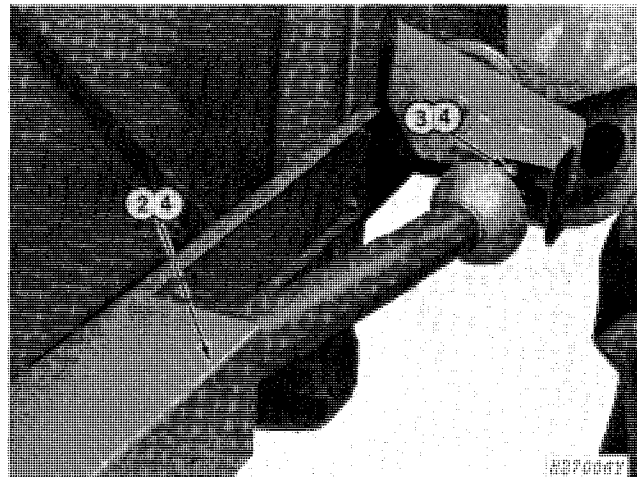

Fig. 100-Connecting Drive Shafts

2. Slide the hex. end of telescoping drive shaft on hex. shaft on the corn head (both sides) (Fig. 100).
3. Slide splined end of drive shaft on the splined feeder house shaft (both sides) (Fig. 100).
4. Tighten clamp bolt on each end of drive shaft (both sides) (Fig. 100).
5. Raise hydraulic cylinder safety stop "B" and hook to chain "A."

**NOTE:** After corn head has been attached to the feeder house, check to be certain the corn head is level.

## PREDELIVERY CHECKS

- Check lubricant in gear cases. See page 10-15-17.
- Check to be certain gatherer chain mechanism is working freely.
- Check gatherer chain guide adjustment. Check all drive chains for proper tension.
- Check timing of stalk rolls, deck plate spacing, and slip clutch settings.
- Be certain row unit drive sprockets are in their correct location.
- Make certain all bolts are tight and cotter pins are spread.
- Run corn head at slow idle for 10 minutes. Listen for slipping clutches. Stop corn head and make a careful check for loose drive chains, heating bearings, and binding parts.
- Run corn head at fast idle for at least 5 minutes. Stop corn head and check gear cases, idlers, and bearings for heating.

## 50 SERIES ROW-CROP HEADS PREDELIVERY

### REMOVING ROW-CROP HEAD FROM SHIPPING SKID

**CAUTION:** Be careful when unloading the row-crop head. If unloading with a fork truck, the forks must be at least 5 feet (1.5 m) long.

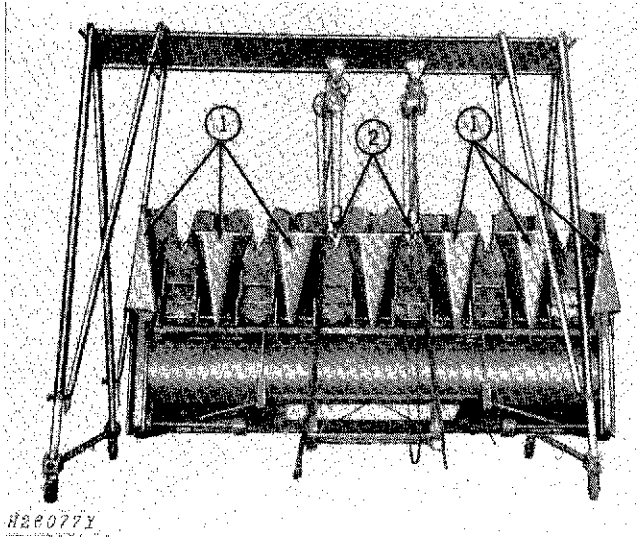

Fig. 101-Attaching Hoist to Row-Crop Head

1. After the row-crop head has been moved to the assembly area, remove gatherer points and drive couplers. Cut all shipping wires and place parts out of the way for later assembly (Fig. 101).

**CAUTION:** Be certain that the overhead hoist or lifting device used has adequate lift and load capacity before removing row-crop head from skid.

2. With the aid of an overhead hoist, attach lift hooks to the shipping channels. Raise row-crop head just high enough so skid uprights and clamps can be removed (Fig. 101).

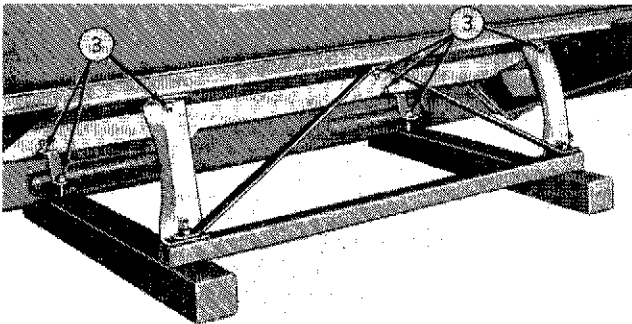

Fig. 102-Removing Shipping Skid

3. Remove clamps and uprights that attach row-crop head to skid (Fig. 102).

Litho in U.S.A.

Position skid under row-crop head frame about halfway between 4 x 4's as illustrated. Slowly lower row-crop head forward to the ground. Remove lift chains and shipping channels from row-crop head.

### INSTALLING OUTER AND INNER GATHERER POINTS

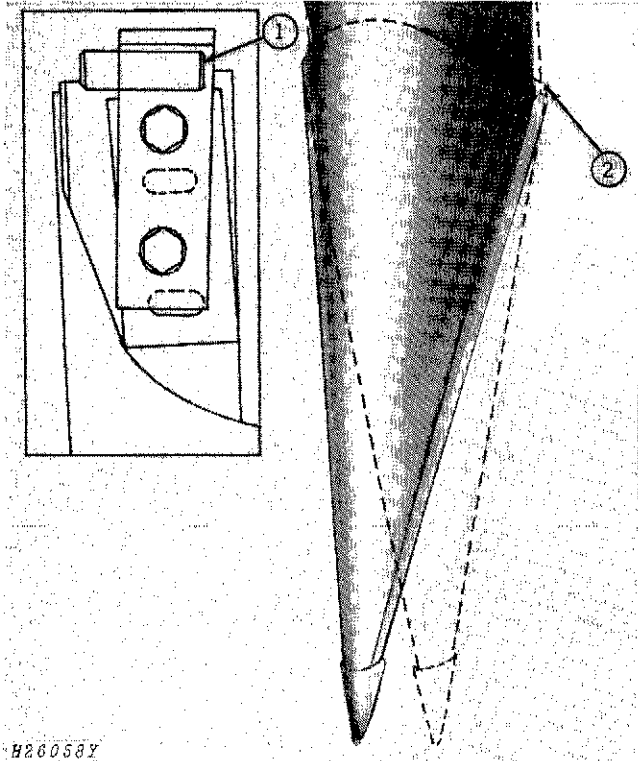

Fig. 103-Installing Outer Gatherer Points

1. Insert hinge pin in hinge hole in outer gatherer sheet (Fig. 103).

2. Attach outer gatherer point to outer gatherer sheet with one 7/16 x 2-inch round head bolt, spacer, 15/32 x 1-1/4 x .105-inch flat washer, lock washer, and nut (Fig. 103).

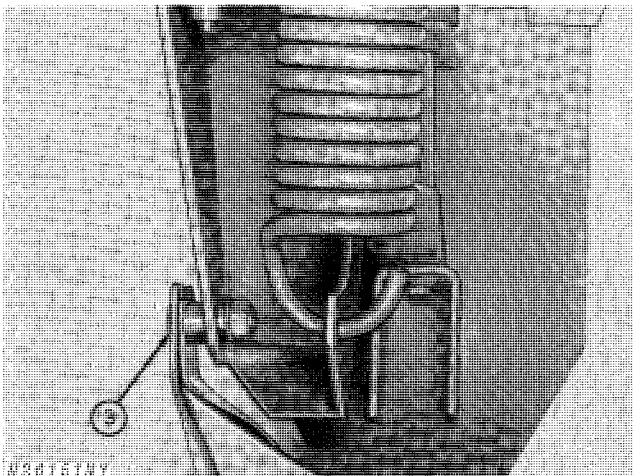

Fig. 104-Installing Inner Gatherer Points

3. Attach inner gatherer point to inner gatherer sheet (both sides) with one 7/16 x 2-inch round head bolt, spacer, 15/32 x 1-1/4 x .105-inch flat washer, lock washer, and nut (Fig. 104).

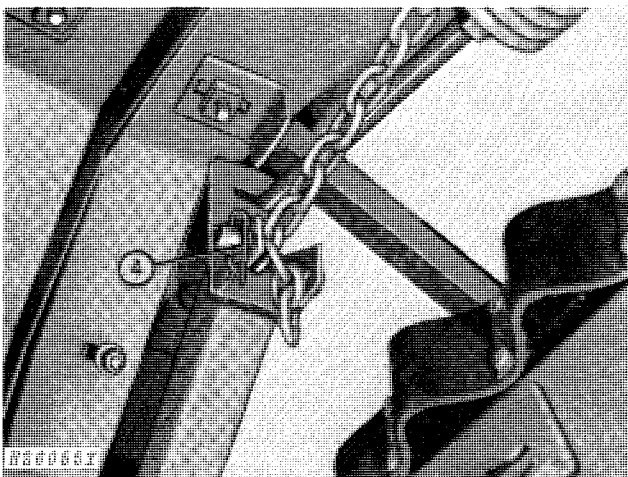

Fig. 105-Adjusting Point Height

4. Attach height adjusting chain to support bracket with drilled pin. Place drilled pin in rear hole and secure with spring locking pin (Fig. 105).

Adjust both outer and all inner gatherer points level with one another.

### ADJUSTING AUTOMATIC HEADER HEIGHT CONTROL LINKAGE

**IMPORTANT:** For the automatic header height control to perform satisfactorily, all row units must be in the floating position and correct row unit float spring tension and gatherer sheet clearance be maintained. Row unit skid shoes must be adjusted for the desired height of cut.

1. Raise row-crop head to maximum height and lower hydraulic cylinder safety stop.

**CAUTION:** Always lower the hydraulic cylinder safety stop when working under the header.

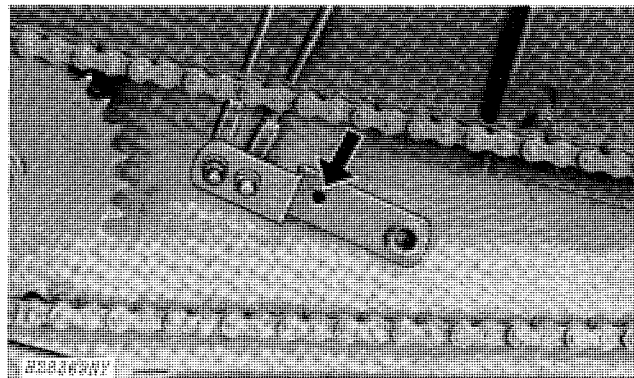

Fig. 106-Lower Actuator Arm

2. Align hole in lower actuator arm with matching hole in bulkhead (Fig. 106). Secure arm in position with pin.

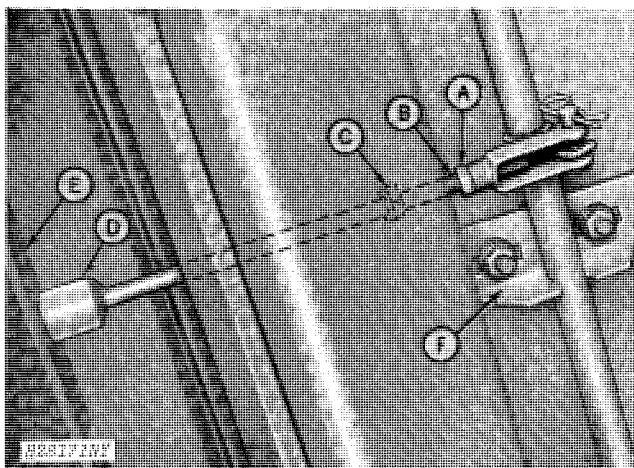

Fig. 107-Automatic Header Height Control Rod

3. Loosen lock nut "A" on actuating rod "B" (Fig. 107).

4. Raise row unit to maximum height and turn adjusting nut "C" on actuating rod until stop "D" lightly rests against row unit bracket "E." (Fig. 107).

5. Tighten lock nut "A" and lower row unit (Fig. 107). Repeat this procedure for each row unit.

6. Adjust stabilizer brackets "F" on control rod to maintain rod in a straight line, the length of the header (Fig. 107).

7. Remove drilled pin and spring locking pin from actuator arm (Fig. 106). Give pins to customer for adjustment of automatic header height control and range indicator.

## MOUNTING ROW-CROP HEAD ON COMBINE

The 453 and 454 row-crop heads are equipped with one quick coupler located on the right-hand side and are driven from the right-hand side of the feeder house.

All other row-crop heads are equipped with two quick couplers, one located on each side of the row-crop head. These row-crop heads are driven from both sides of the feeder house.

Drive the combine forward until the two attaching blocks on top of the feeder house are under the main frame tube and the feeder house is against the row-crop head frame. Raise the feeder house with the row-crop head as high as possible.

Shut off combine engine and lower hydraulic cylinder safety stop

**CAUTION:** Be certain to lower hydraulic cylinder safety stop before installing attaching bolts and connecting couplers.

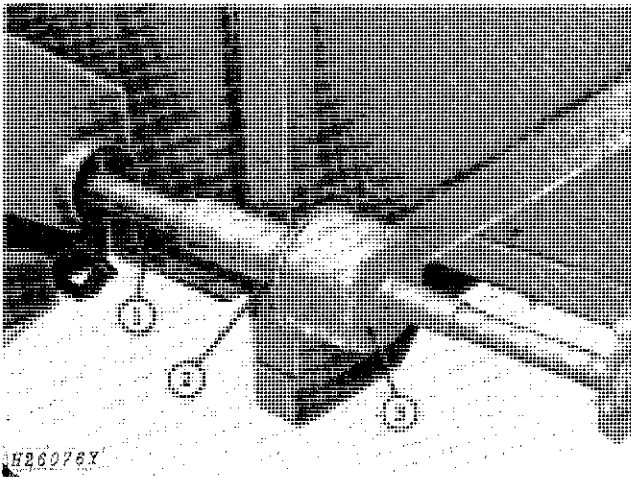

Fig. 108-Securing Row-Crop Head and Feeder House Together

1. Secure the row-crop head and feeder house together with three 1/2 x 1-1/2-inch round head bolts (Fig. 108).

### (6600 and 7700 Combines)

2. Slide the feeder house coupler sprocket against the row-crop head coupler sprocket (Fig. 108). Teeth on the sprockets must be positioned directly across from one another. Install chain around sprockets. Slide the feeder house coupler housing back and let it snap over the sprockets and chain. The coupler housing encloses the sprockets and chain together.

3. Slide the row-crop head slip clutch shield over the slip clutch (Fig. 108).

Litho in U.S.A.

### (SideHill 6600 Combine)

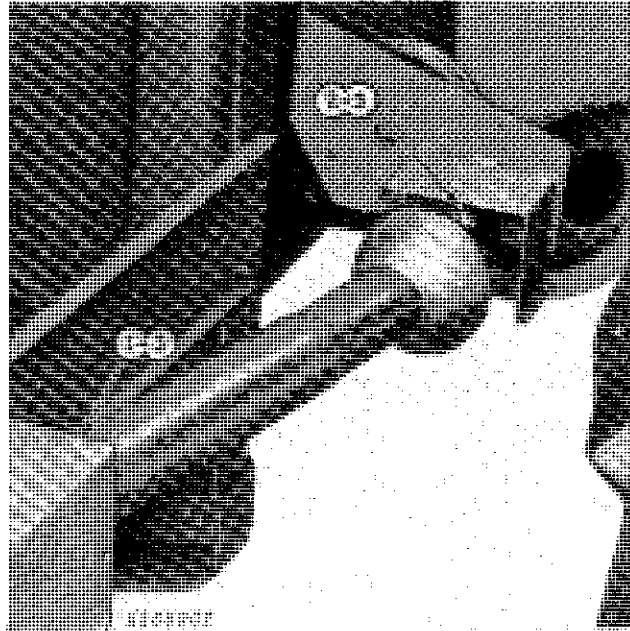

Fig. 109-Connecting Drive Shafts

1. Slide hex end of telescoping shaft on hex shaft of row-crop head (Fig. 109).
2. Slide splined end of drive shaft on the splined feeder house shaft (both sides) (Fig. 109).
3. Tighten clamp bolt on each end of drive shaft (both sides) (Fig. 109).

### (All Combines)

If combine is equipped with automatic header height control, connect height control wiring harness.

Raise hydraulic cylinder safety stop and lower row-crop head to ground.

## PREDELIVERY CHECKS

Adjust inner gatherer sheet clearance for 1/8-inch (3 mm).

Depending on the crop to be first harvested, adjust row units for either floating or rigid operation.

Check all drive chains for proper tension, timing and tension of gathering belts, rotary knives for proper cut, and cross auger clearances.

Make certain all bolts are tight and cotter pins are spread.

Run row-crop head at slow idle for 10 minutes. Stop row-crop head and make a careful check for loose drive chains, heating bearings, and binding parts.

Run row-crop head at fast idle for at least 5 minutes. Stop row-crop head and check for heating bearings.

## INSTALLATION OF AUTOMATIC HEADER HEIGHT CONTROL PARTS ON 200 SERIES FLEX CUTTING PLATFORMS

**NOTE:** The cutterbar must be unlocked or in the flex position before automatic header height control parts can be installed on the platform. See operator's manual for 200 Series Cutting Platforms.

Remove right-hand floating divider point and end shield for easier installation of parts on the platform.

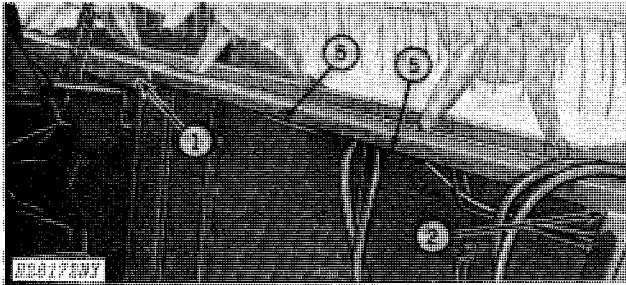

Fig. 110-Routing Conduit  
(220 Flex Platform Illustrated)

1. Attach a piece of stiff wire, approximately 5 ft. (1.5 m) long, to the plug end of the wiring harness. Starting at the right-hand side of the feeder house, route harness through platform top beam (Fig. 110). Connect harness to harness on top of feeder house.

2. Route conduit along under side of top beam and through hole in end sheet (Fig. 110).

**NOTE:** For Steps 3 and 4, see Page 10-10-45 for electrical wiring diagram.

3. Connect yellow wire to center terminal (normal open) and the double light blue wire to end terminal (common) of RAISE switch. Be certain terminal connections are secure.

4. Connect orange wire to center terminal (normal open) and light blue wire to end terminal (common) of LOWER switch. Be certain terminal connections are secure.

5. Secure conduit to hydraulic hoses with self-locking bands as required (Figs. 110 and 111).

**NOTE:** A common conduit is provided for installation on all sizes of 200 Series Platforms. Coil excess conduit (smaller platforms) and secure with self-locking band (Fig. 111). Allow enough conduit for the connection at the feeder house.

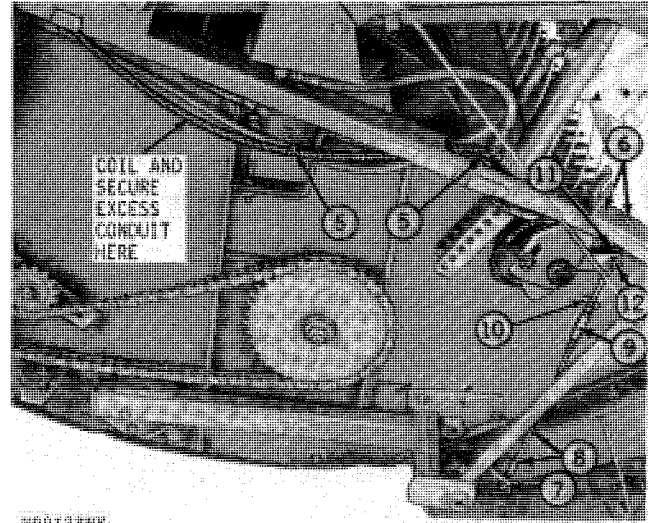

Fig. 111-Installing Header Height Control Parts

6. Attach switch assembly to the under side of end sheet edge with two existing round head bolts and nuts (Fig. 111).

7. Attach a ball joint to the sensing rod bracket with a 3/8-inch fine thread nut (Fig. 111).

8. Thread left-hand (long) push rod link in ball joint and lock with a 5/16-inch fine thread jam nut (Fig. 111).

9. Thread turnbuckle on left-hand push rod link (Fig. 111).

10. Thread 5/16-inch wing nut on right-hand (short) push rod link and then thread link into turnbuckle (Fig. 111).

11. Thread the other ball joint on right-hand (short) push rod link and lock with a 5/16-inch fine thread jam nut (Fig. 111).

12. Attach upper ball joint to cam arm with a 3/8-inch fine thread nut (Fig. 111).

## INSTALLATION OF AUTOMATIC HEADER HEIGHT CONTROL PARTS ON 50 SERIES ROW-CROP HEADS

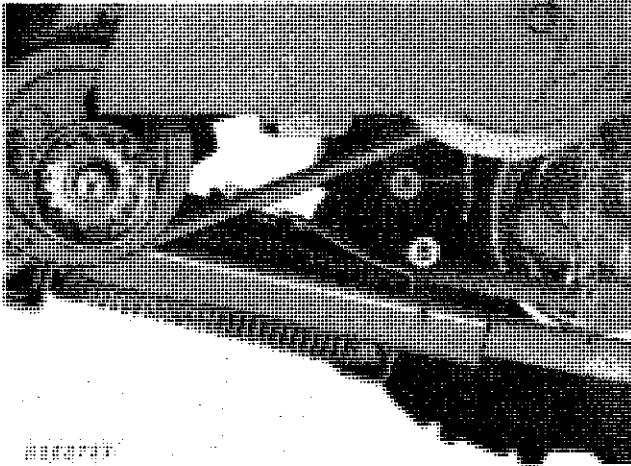

Fig. 112-Safety Stop

A—Support Chain

B—Safety Stop

(Safety Position)

**⚠ CAUTION: Always use the safety stop when working on the header.**

To place the stop in safety position, first extend hydraulic cylinders. Disconnect the support chain "A" from the safety stop "B" and position the safety stop on the piston rod (Fig. 112).

After completing the work, attach safety stop to support chain for storage.

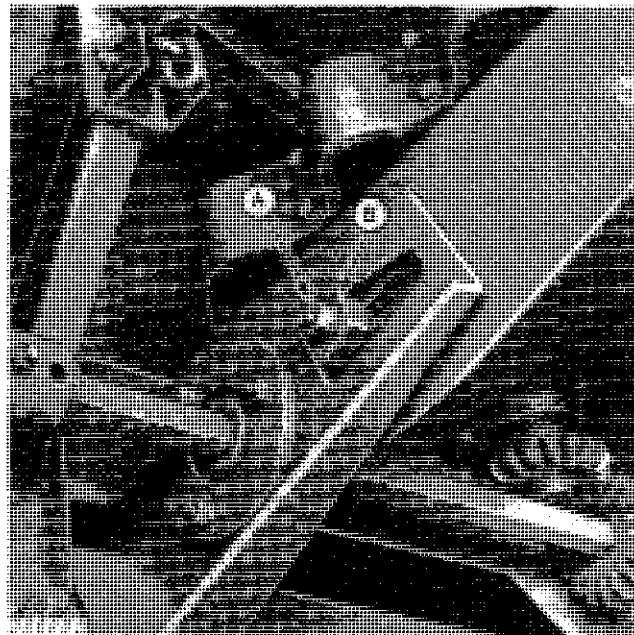

Fig. 113-Floating Position

All row units must be adjusted to the floating position before performing the steps on the following pages.

**⚠ CAUTION: Always lower the hydraulic cylinder safety stop when working under the header.**

To adjust row units to the floating position, raise header to maximum height and lower hydraulic cylinder safety stop (Fig. 112).

On both sides of the row unit frame, loosen nut "A" and drive lock-out wedge "B" rearward (Fig. 113).

Tighten nut "A".

Repeat this procedure for each of the row units.

Raise hydraulic cylinder safety stop and lower header to ground.

## INSTALLATION OF AUTOMATIC HEADER HEIGHT CONTROL PARTS ON 50 SERIES ROW-CROP HEADS—(Continued)

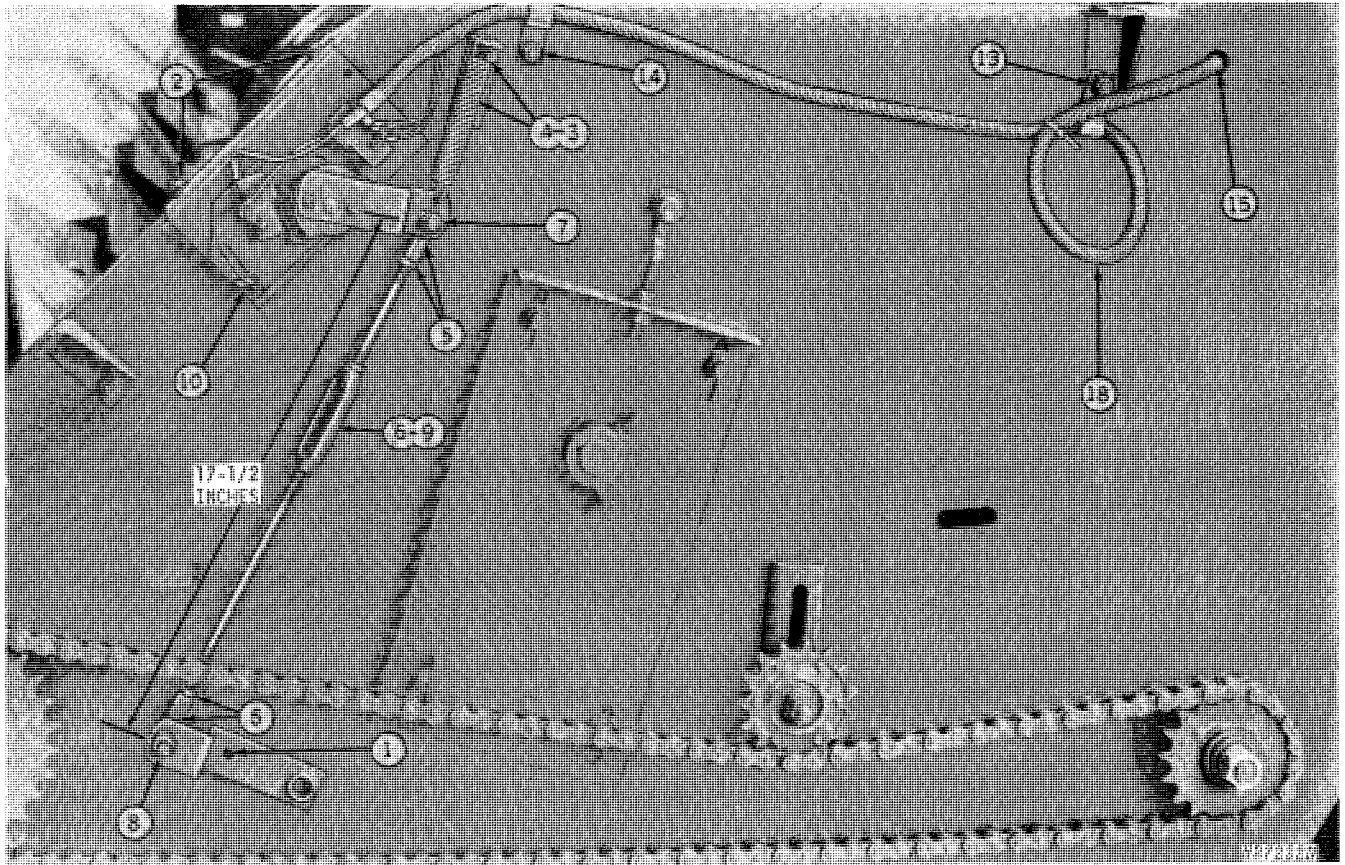

Fig. 114—Installing Header Height Control Parts  
(Outer Sheet Removed for Illustrative Purposes)

1. Remove pin holding arm in fixed position (Fig. 114). Retain pin for future use to check setting of actuating rod.
2. Using existing holes, attach switch mounting plate with two 5/16 x 3/4-inch cap screws, lock washers, and nuts (Fig. 114).
3. Using existing holes, attach spring bracket to end sheet with two 5/16 x 3/4-inch round head bolts, 11/32 x 11/16 x .060-inch flat washers, lock washers, and nuts (Fig. 114). Push spring bracket upward in slots as far as possible, before tightening hardware.
4. Place spring through holes in arm and spring bracket as shown (Fig. 114).
5. Thread left-hand and right-hand push rod links into ball joints as far as possible and lock with 5/16-inch jam nuts (Fig. 114).
6. Thread jam nut, then turnbuckle, onto (short) right-hand push rod link. Then thread turnbuckle onto (long) left-hand push rod link (Fig. 114).
7. Insert ball joint with (short) right-hand push rod link through upper arm and secure with 3/8-inch lock washer and nut (Fig. 114).
8. Insert ball joint with (long) left-hand push rod link through lower actuator arm and secure with 3/8-inch lock washer and nut (Fig. 114).
9. Adjust turnbuckle until a dimension of 17-1/2 inches (445 mm) is reached from center of each nut (Fig. 114).
10. Loosen wing nut and rotate lower switch adjusting bracket as far left as possible (Fig. 114). Tighten wing nut.

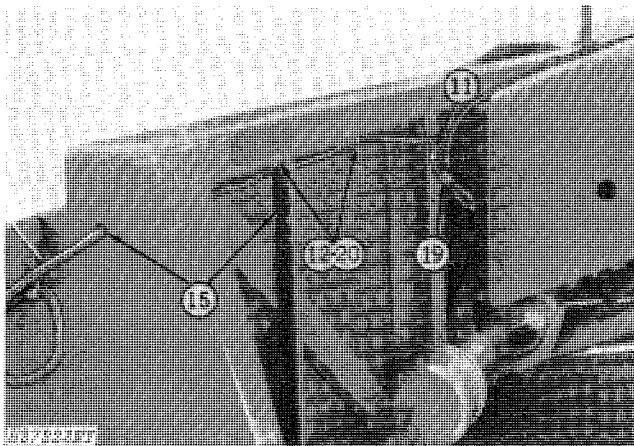

Fig. 115-Installing Clamps and Routing Conduit (653 Row-Crop Head Illustrated)

**NOTE:** In following Steps 11, 12, 13, and 14, do not tighten hardware until conduit is installed.

11. Install "J" clamp, using 5/16 x 5/8-inch round head bolt, lock washer, and nut (Fig. 115).

12. Install "J" clamp. 453 and 454 Row-Crop Heads use one "J" clamp with existing hardware (Fig. 115). Larger row-crop heads use two "J" clamps with existing hardware.

13. Install "J" clamp on side sheet, using existing hardware (Fig. 114).

14. Install "J" clamp on side sheet, using 5/16 x 3/4-inch round head bolt, lock washer, and nut (Fig. 114).

15. Run conduit on back sheet of row-crop head, through "J" clamps, under brace, and through hole in side sheet and under two more "J" clamps (Fig. 115).

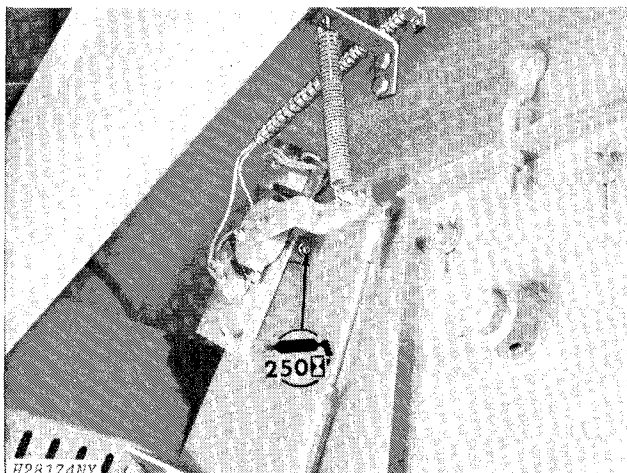

Fig. 116-Cam Pivot Shaft

Lubricate cam pivot shaft with SAE multi-purpose type grease (Fig. 116).

**NOTE:** For Steps 16 and 17, see Page 10-10-45 for electrical wiring diagram.

16. Connect yellow wire to center terminal (normal open) and the double light blue wire to end terminal (common) of RAISE switch. Be certain terminal connections are secure.

17. Connect orange wire to center terminal (normal open) and light blue wire to end terminal (common) of LOWER switch. Be certain terminal connections are secure.

18. Move extra conduit back to area shown and secure two side "J" clamps (Fig. 114).

19. Be certain there is enough conduit to connect two conduit connectors from feeder house and header (Fig. 115).

20. Secure two or three rear "J" clamps (Fig. 115).

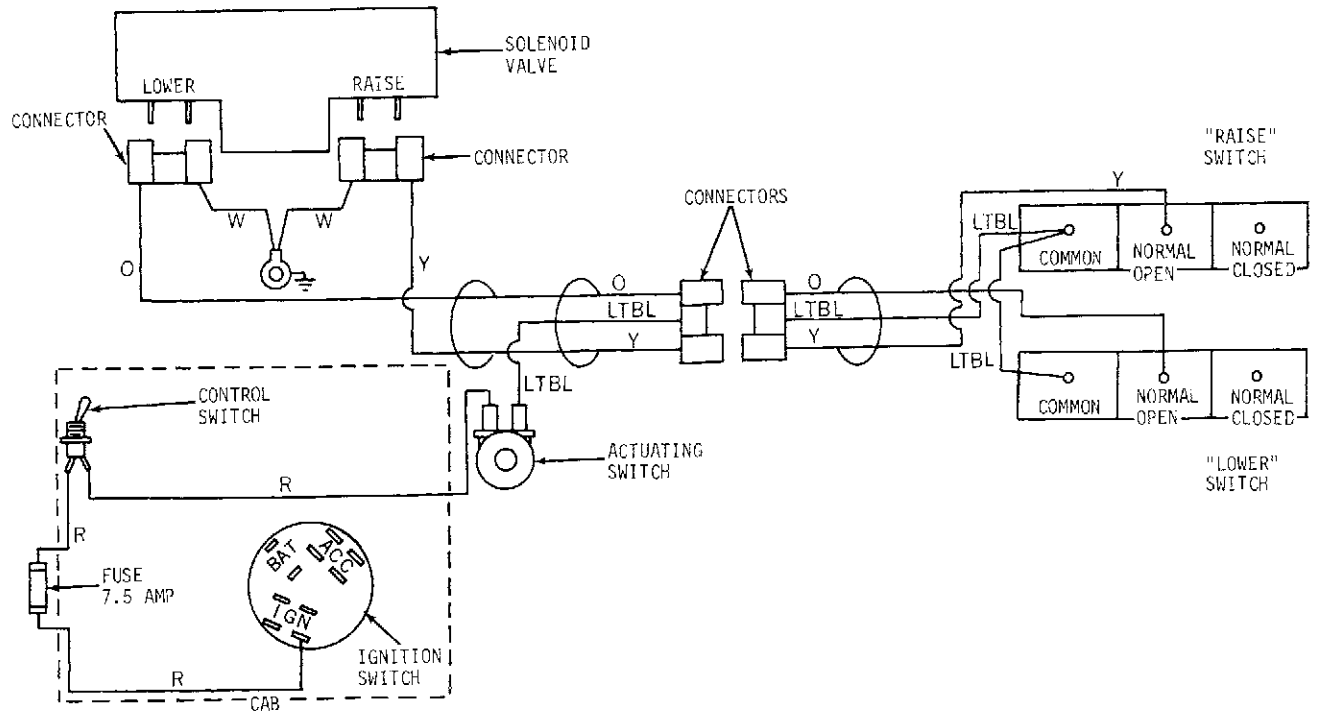

H25896N

LTBL—Light Blue  
 O—Orange  
 R—Red

W—White  
 Y—Yellow

Fig. 117-Automatic Header Height Control Wiring Diagram

## ADJUSTING HEIGHT SENSING HEADER SWITCHES ON 200 SERIES FLEX CUTTING PLATFORMS

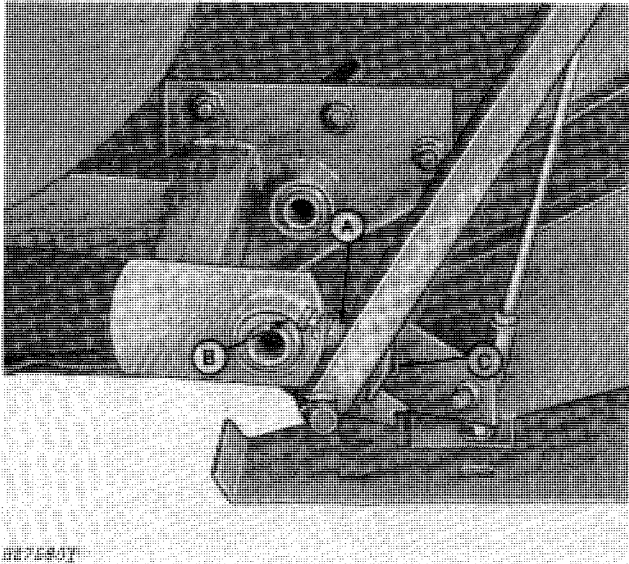

Fig. 118-Adjusting Range Indicator  
(Divider Point Removed  
for Illustrative Purposes)

The range indicator, located on the right-hand side of the platform, lets the operator know at a glance where the cutterbar is in the desired float range (usually between [0] and [2]).

1. It is important to check to be certain that the platform is level. Adjust tilt angle of cutterbar for existing crop and ground conditions. See 200 Series Cutting Platforms Operator's Manual for these adjustments.

**IMPORTANT: The cutterbar must be unlocked or in the flex position before adjustment of header switches can be completed.**

2. Lower platform all the way to the ground. Loosen lock nut (A) and turn adjusting screw (B) until screw touches stop (C) (Fig. 118). Red range indicator ball must be centered on (0) or zero.

3. Loosen wing nut "A" and rotate turnbuckle "B" to lengthen rod "C" until raise switch clicks (Fig. 119). Then rotate turnbuckle one additional turn and tighten wing nut "A".

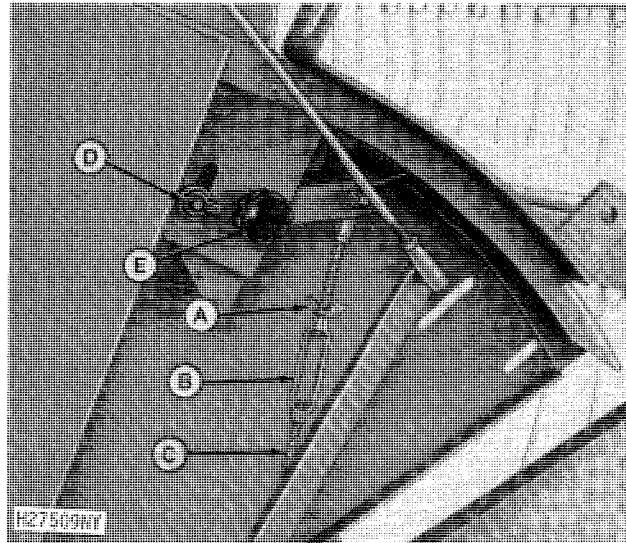

Fig. 119-Adjusting Switches

4. Start combine engine and raise platform until the red range indicator ball is on "2". Loosen wing nut "D" and rotate knob "E" counterclockwise until the lower switch clicks (Fig. 119). Tighten wing nut.

*NOTE: To check setting of raise switch, raise platform to maximum height and lower hydraulic cylinder safety stop. Push cutterbar up, by hand, at each sensor pad and have another person listen for raise switch to click. If raise switch does not click when cutterbar is pushed up at each sensor pad, continue to lengthen rod "C" (Fig. 119) until switch clicks.*

5. Adjust drop rate valve. See Page 10-10-49.

*NOTE: To readjust header switches for wet ground conditions, reposition raise switch by lengthening the turnbuckle rod several turns. If the platform "hunts," turn drop rate valve adjusting screw in until "hunting" stops or reposition lower switch for a wider operating range. This setting will cause the cutterbar to operate in the lower part of the 4-inch (102 mm) float range. Remember,*

Shorter Rod Length—Raise switch closes nearer upper stop (dry ground conditions).

Longer Rod Length—Raise switch closes nearer lower stop (wet ground conditions).

## ADJUSTING HEIGHT SENSING HEADER SWITCHES ON 50 SERIES ROW-CROP HEADS

**IMPORTANT:** For the optional automatic header height control to perform satisfactorily, the following adjustments must be made before the height sensing switches on the row-crop head can be adjusted.

Refer to the 50 Series Row-Crop Head Operator's Manual and make the following adjustments.

Adjust each row unit for floating operation.

Adjust row unit float spring tension for floating operation.

Adjust row unit skid shoes for the desired height of cut.

Adjust inner gatherer sheet clearance.

1. Raise header to maximum height and lower hydraulic cylinder safety stop.

**CAUTION:** Always lower the hydraulic cylinder safety stop when working under the header.

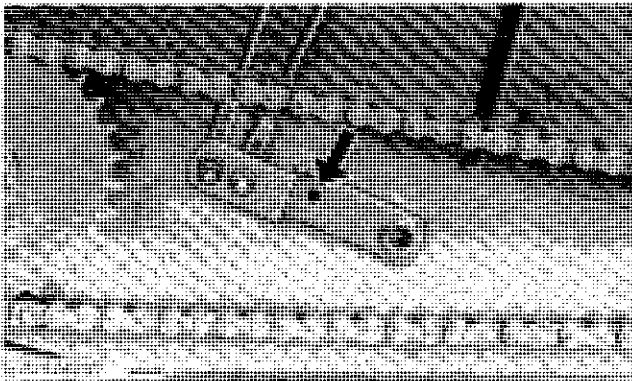

Fig. 120-Securing Arm

2. Align hole in lower actuator arm with matching hole in bulkhead (Fig. 120). Secure arm in position with pin.

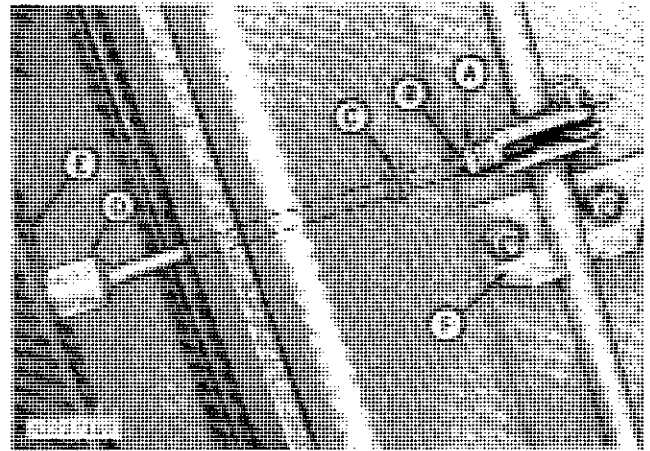

Fig. 121-Adjusting Actuating Rod

3. Loosen lock nut "A" on actuating rod "B" (Fig. 121).

4. Raise row unit to maximum height and turn adjusting nut "C" on actuating rod until stop "D" lightly rests against row unit bracket "E" (Fig. 121). Adjust stabilizer brackets "F" on control rod, to maintain rod in a straight line, the length of the header.<sup>†</sup>

5. Tighten lock nut "A" and lower row unit. Repeat procedure for each row unit and retain pin for future use (Fig. 121).

6. Adjust row unit float spring tension until the row unit begins to raise from the lower stop or until the row unit can be pushed upward easily (approximately 10-15 lbs. [5-7 kg] at skid shoe), with the header in the raised position. See 50 Series Row-Crop Head Operator's Manual.

## ADJUSTING HEIGHT SENSING SWITCHES—(Continued)

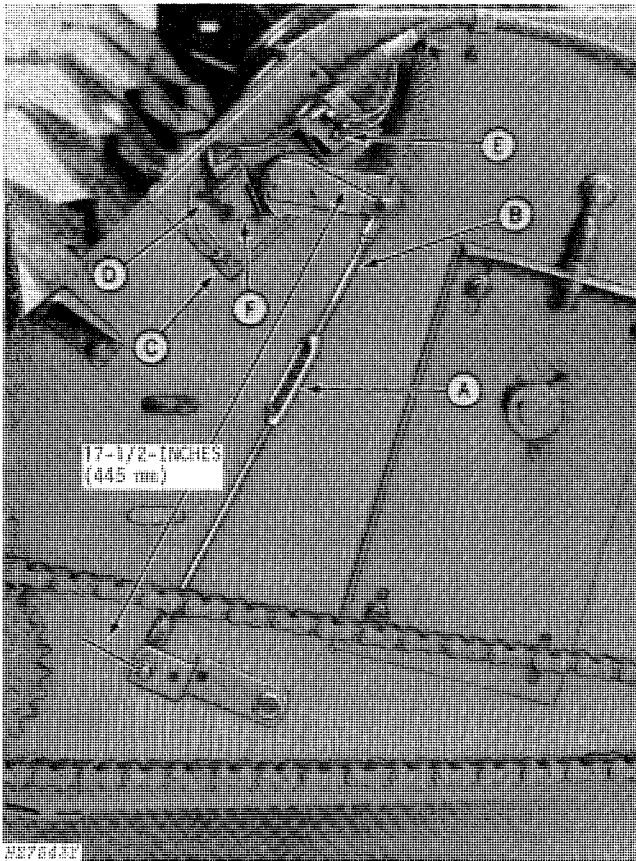

Fig. 122-Adjusting Height Sensing Switches  
(Left-Hand Outer Gatherer Sheet  
Removed for Illustrative Purposes)

7. Check to be certain push rod tension spring bracket is adjusted up as far as possible, to maintain maximum spring tension.

8. Loosen lock nut and lengthen turnbuckle "A" until push rod "B" activates or clicks the raise switch "E", then rotate turnbuckle one more turn and tighten lock nut (Fig. 122).

9. Loosen screw "C" and rotate lower switch adjusting bracket "D" fully clockwise (Fig. 122).

10. Turn drop rate valve adjusting screw out until header "hunts" or cycles up and down. See page 10-10-49. Turn adjusting screw in until header stops "hunting", then turn adjusting screw in an additional 1/2 turn.

*NOTE: After making the initial adjustment on the push rod in step 8, it may be necessary to readjust the header switches to reduce skid shoe pressure when operating in wet soil conditions.*

To readjust the header switches, reposition raise switch "E" by shortening turnbuckle "A" approximately three turns initially. Check to be certain that the lower switch can still be activated. If lower switch requires readjusting, it may be necessary to repeat step 10 to stop "hunting."

*NOTE: It may be necessary to further adjust the turnbuckle and the lower switch to achieve proper skid shoe pressure.*

This setting will cause the row unit to operate in the lower part of the 6-inch (152 mm) range, where skid shoe pressure is less.

*NOTE: If the float spring attachment is used with automatic header height control, the tension on the float springs must be reduced until the header lift cylinders extend and retract without the front channels opening. See combine operator's manual.*

## ADJUSTMENTS ON SEPARATOR (ALL HEADERS)

### ADJUSTING DROP RATE VALVE (Header Drop Rate)

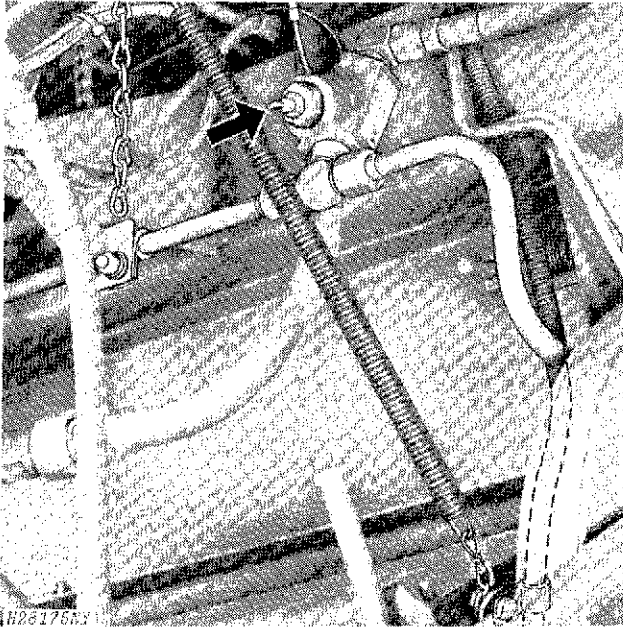

Fig. 123-Adjusting Drop Rate

The drop rate valve controls the rate of drop of the header.

Turn the drop rate valve adjusting screw out until the header "hunts" or cycles up and down (Fig. 123).

Turn adjusting screw in until the header stops "hunting."

Turn adjusting screw in an additional 1/2 turn.

**NOTE:** The initial setting of the drop rate valve adjusting screw is eight complete turns out.

### ADJUSTING ACTUATING SWITCH CHAIN

The actuating switch shuts off the automatic header height control when the header is raised approximately 18 inches (457 mm) above the ground.

A chain, attached to the switch, holds the switch closed when the header is raised.

**NOTE:** If the chain is adjusted too long, it will not release the actuating switch and the automatic header height control will not operate.

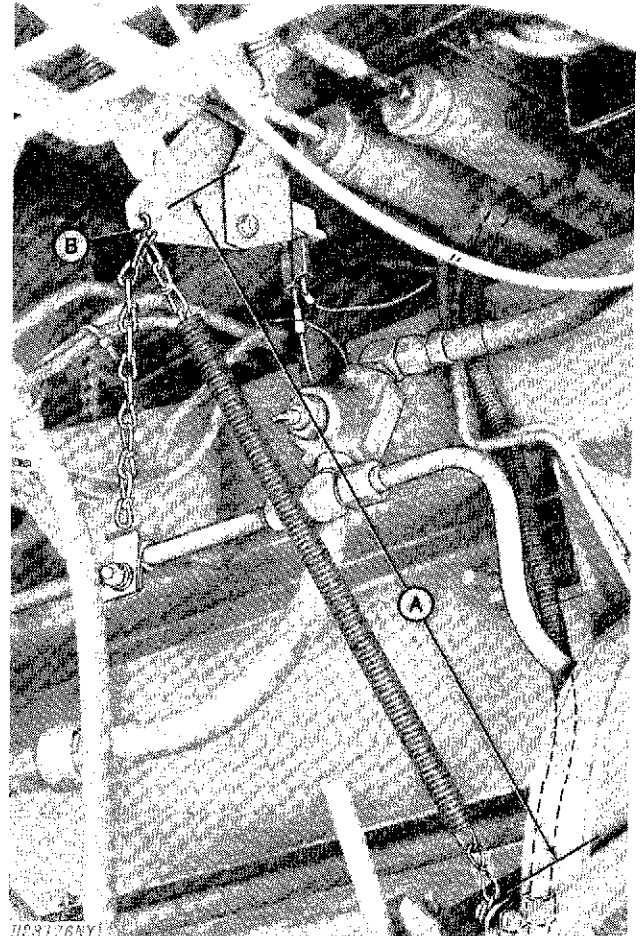

Fig. 124-Adjusting Switch Chain

If the chain is adjusted too short, the header can be raised manually, but will continue to lower when the lever is released. In addition, if the chain is adjusted too short, the system will not shut off unless the control switch is turned to the "OFF" position.

The length "A" (Fig. 124) of the actuating switch chain should be adjusted to approximately 16 inches  $\pm$  1/2-inch (406 mm  $\pm$  13 mm).

The above specified chain length opens the actuating switch approximately 18 inches (457 mm) above the ground.

To adjust actuating switch chain length, note existing position of chain.

Remove hook "B" (Fig. 124) and insert it in the desired link.

## FUSE

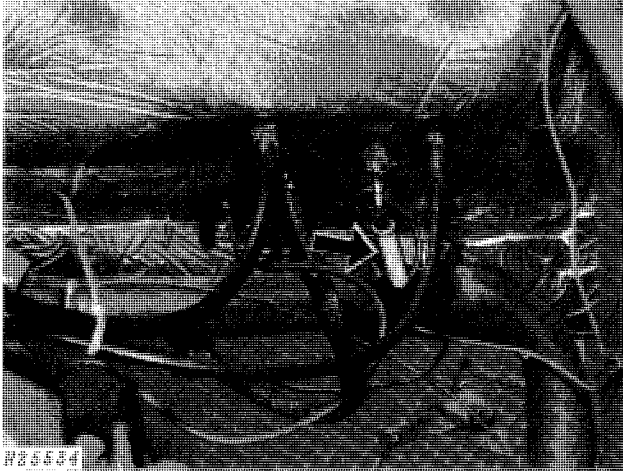

Fig. 125-Fuse

The electrical system of the automatic header height control is protected from overload by a 7.5 amp in-line fuse. This fuse is located in the engine compartment next to the firewall (Fig. 125).

If the electrical circuit overloads and blows the fuse, determine the cause by checking for shorted wiring. After correcting the cause, replace fuse.

The 7.5 amp fuse for the electrical portion of the automatic header height control is available as Part No. AH80089.

**IMPORTANT: Be certain to use only a 7.5 amp fuse to protect the electrical system. Serious damage can result if a larger fuse is used and a malfunction occurs.**

## DISCONNECTING AUTOMATIC HEADER HEIGHT CONTROL

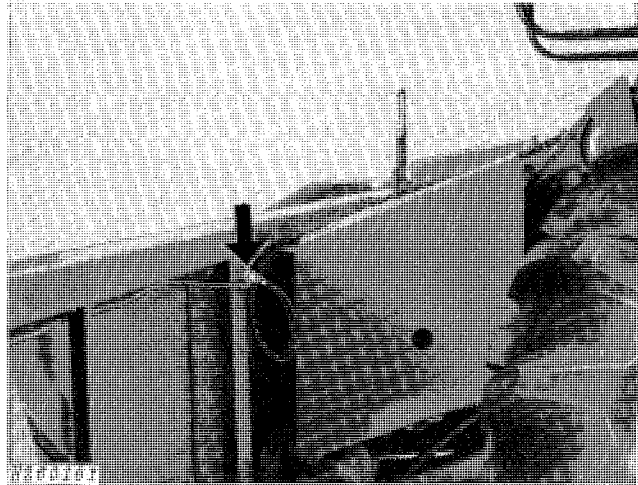

Fig. 126-Disconnecting Harness

Whenever the header is removed from the combine, the wiring harness for the automatic header height control must be disconnected.

To disconnect wiring harness, pull connectors apart and lay harness on feeder house (Fig. 126).

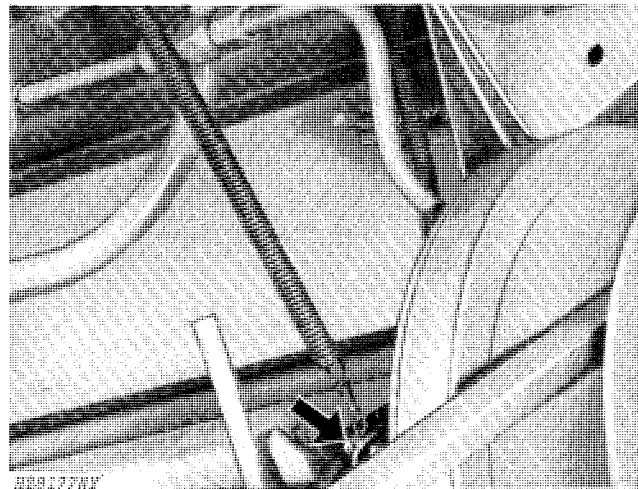

Fig. 127-Disconnecting Switch Chain

*NOTE: When removing feeder house from separator, disconnect wiring harness, as illustrated, and remove harness from clamps on feeder house. Coil harness and store under operator's platform for future use.*

To disconnect the actuating switch chain, remove the chain attaching hook on the upper left-hand side of the feeder house (Fig. 127).



**Suggest:**

**If the above button click is invalid.**

**Please download this document**

**first, and then click the above link**

**to download the complete manual.**

**Thank you so much for reading**

## DELIVERY SERVICE

A thorough discussion of the operation and service of a new combine or header at the time of delivery helps to assure complete customer satisfaction. Proper delivery should be an important phase of a dealer's program.

Many complaints arise simply because the owner is not shown how to operate and service the new combine or header properly. Enough time should be devoted, at the customer's convenience, to introducing the new combine or header and explaining how to operate and service it.

Use the operator's manual as a guide and be certain the owner understands these points thoroughly.

1. The importance of safety.
2. The importance of lubrication and periodic service.
3. Controls and instruments..
4. How to start and stop the engine.
5. All functions of the hydraulic system.
6. Transporting.

## AFTER-SALE INSPECTION

The purchaser of a new John Deere combine or header is entitled to a free inspection by the dealer at some mutually agreeable time within the operational season.

The purpose of this inspection is to make certain that the customer is receiving satisfactory performance from the combine or header. The inspection should reveal whether or not the machine is being operated, lubricated, and serviced properly.

With this recommended after-sale service inspection, you may eliminate needless service work by preventing minor irregularities from developing into serious problems later. This will promote strong dealer-customer relations and present you with an opportunity to answer questions that may have arisen.

Use this inspection period to acquaint the customer with any special attachments which will help him to do a better job with his machine.

**<https://www.ebooklibonline.com>**

Hello dear friend!

Thank you very much for reading.

Enter the link into your browser.

The full manual is available for immediate download.

**<https://www.ebooklibonline.com>**