

JOHN DEERE
AG & TURF DIVISION

Compact Utility Tractor
4005

OMLVU19592 E2

OPERATOR'S MANUAL



JOHN DEERE

⚠ WARNING: Diesel engine exhaust and some of its constituents are known to the State of California to cause cancer, birth defects, and other reproductive harm.

California Proposition 65 Warning

North American Version
Litho in U.S.A.

Introduction

Thank You for Purchasing a John Deere Product

We appreciate having you as a customer and wish you many years of safe and satisfied use of your machine.

Using Your Operator's Manual

This manual is an important part of your machine and should remain with the machine when you sell it.

Reading your operator's manual will help you and others avoid personal injury or damage to the machine. Information given in this manual will provide the operator with the safest and most effective use of the machine. Knowing how to operate this machine safely and correctly will allow you to train others who may operate this machine.

If you have an attachment, use the safety and operating information in the attachment operator's manual along with the machine operator's manual to operate the attachment safely and correctly.

This manual and safety signs on your machine may also be available in other languages (see your authorized dealer to order).

Sections in your operator's manual are placed in a specific order to help you understand all the safety messages and learn the controls so you can operate this machine safely. You can also use this manual to answer any specific operating or servicing questions. A convenient index located at the end of this book will help you to find needed information quickly.

The machine shown in this manual may differ slightly from your machine, but will be similar enough to help you understand our instructions.

RIGHT-HAND and LEFT-HAND sides are determined by facing in the direction the machine will travel when going forward. When you see a broken line (-----), the item referred to is hidden from view.

Before delivering this machine, your dealer performed a predelivery inspection to ensure best performance.

Special Messages

Your manual contains special messages to bring attention to potential safety concerns, machine damage as well as helpful operating and servicing information. Please read all the information carefully to avoid injury and machine damage.



CAUTION: Avoid injury! This symbol and text highlight potential hazards or death to the operator or bystanders that may occur if the hazards or procedures are ignored.

IMPORTANT: Avoid damage! This text is used to tell the operator of actions or conditions that might result in damage to the machine.

NOTE: General information is given throughout the manual that may help the operator in the operation or service of the machine.

Attachments for Your Machine

There's a John Deere attachment or kit to make your new machine perform more tasks or be more versatile, whether your machine is a lawn tractor or compact utility tractor or a utility vehicle.

You can check out the entire line of attachments for your machine at JohnDeere.com or ask your John Deere dealer. From aerators to electric lift kits to tillers, there's a John Deere attachment or kit to fill every need.

Product Identification

Record Identification Numbers

Compact Utility Tractor

4005 PIN (000101 -)

If you need to contact an Authorized Service Center for information on servicing, always provide the product model and serial number.

You will need to locate the model and serial number for the machine and for the engine of your machine and record the information in the spaces provided below.

DATE OF PURCHASE:

DEALER NAME:

DEALER PHONE:

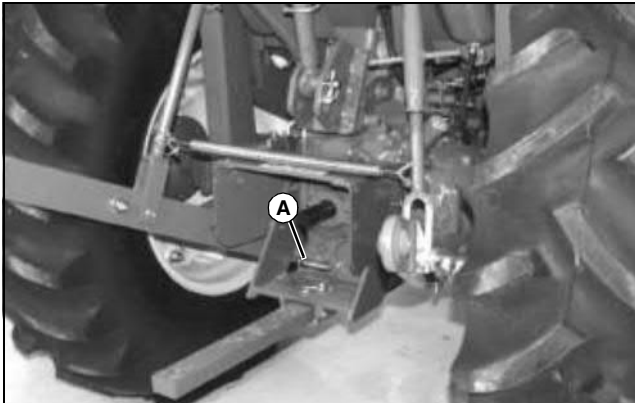

MX4102

PRODUCT IDENTIFICATION NUMBER (A):

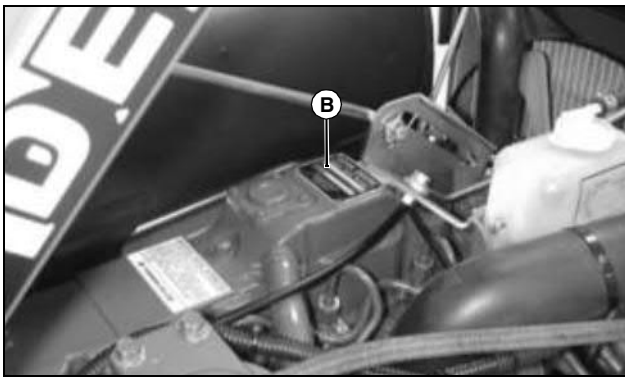

MX20572

ENGINE SERIAL NUMBER (B):

<https://www.ebooklibonline.com>

Hello dear friend!

Thank you very much for reading.

Enter the link into your browser.

The full manual is available for immediate download.

<https://www.ebooklibonline.com>

Table of Contents

Safety Labels	1
Safety	4
Operating - Controls	17
Operating	18
Replacement Parts	39
Service Intervals	40
Service Lubrication	42
Service Engine	44
Service Transmission	55
Service Electrical	58
Service Miscellaneous	64
Troubleshooting	73
Storage	78
Assembly	80
Specifications	82
Warranty	87
Index	90

Original Instruction

All information, illustrations and specifications in this manual are based on the latest information at the time of publication. The right is reserved to make changes at any time without notice.

COPYRIGHT© 2012

Deere & Co.

John Deere Ag & Turf Division

All rights reserved

Previous Editions

COPYRIGHT© 2007, 2008, 2009

OMLVU19592 E2 -

Safety Labels

Safety Label Location

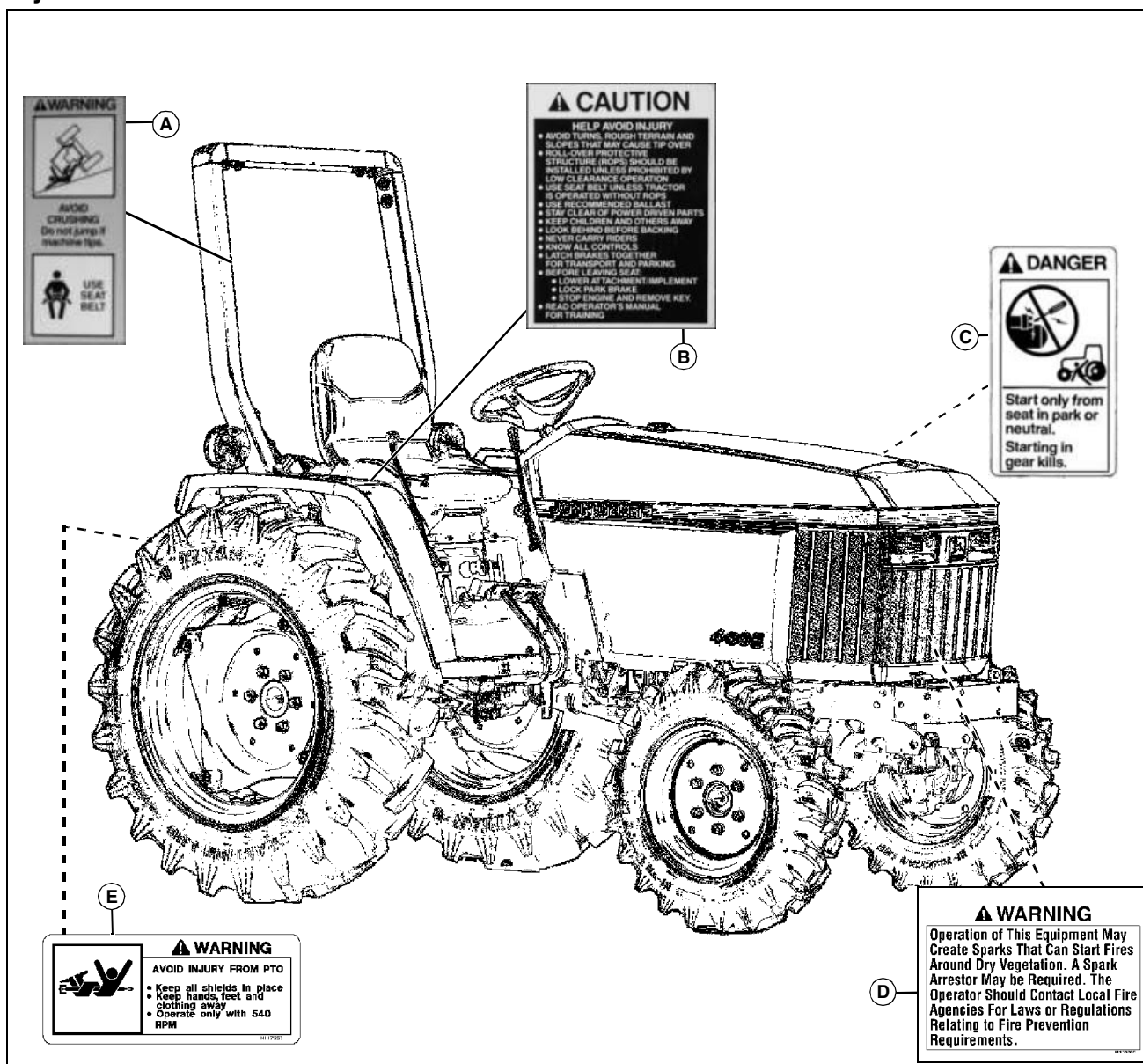

MX42077

Picture Note: Use label number listed in table below to locate complete text of safety label message following this illustration.

- A - WARNING LVU800915
- B - CAUTION LVU803815
- C - DANGER T146102
- D - WARNING M159705
- E - WARNING LVU801032



Understanding The Machine Safety Labels

The machine safety labels shown in this section are placed in important areas on your machine to draw attention to potential safety hazards.

On your machine safety labels, the words DANGER, WARNING, and CAUTION are used with this safety-alert symbol. DANGER identifies the most serious hazards.

The operator's manual also explains any potential safety hazards whenever necessary in special safety messages that are identified with the word, CAUTION, and the safety-alert symbol.

Safety Labels

WARNING - LVU800915

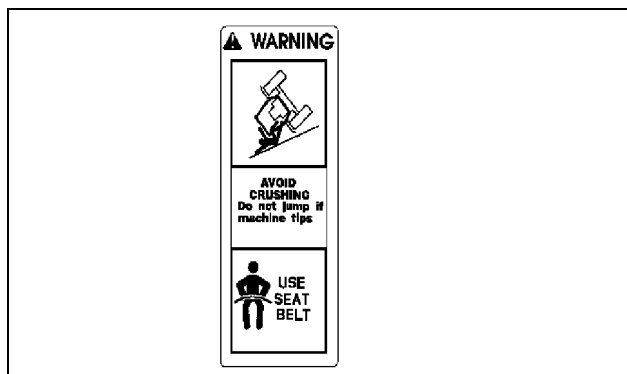

LVU800915

- AVOID CRUSHING
- Do not jump if machine tips
- USE SEAT BELT

DANGER T146102



T146102

- Start only from seat in park or neutral.
- Starting in gear kills.

WARNING M117557

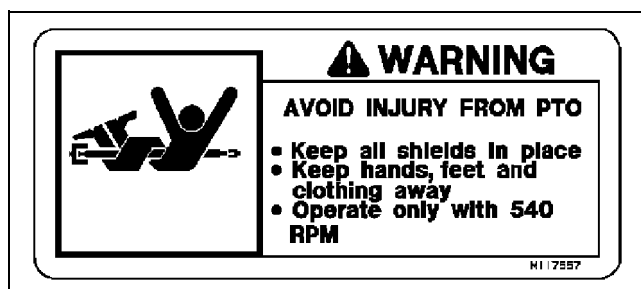

M117557

AVOID INJURY FROM PTO.

- Keep all shields in place.
- Keep hands, feet and clothing away.
- Operate only with 540 RPM.

CAUTION - LVU803815

HELP AVOID INJURY



LVU803815

- AVOID TURNS, ROUGH TERRAIN AND SLOPES THAT MAY CAUSE TIP OVER.
- ROLL-OVER PROTECTIVE STRUCTURE (ROPS) SHOULD BE INSTALLED UNLESS PROHIBITED BY LOW CLEARANCE OPERATION.
- USE SEAT BELT UNLESS TRACTOR IS OPERATED WITHOUT ROPS.
- USE RECOMMENDED BALLAST.
- STAY CLEAR OF POWER DRIVEN PARTS.
- KEEP CHILDREN AND OTHERS AWAY.
- LOOK BEHIND BEFORE BACKING.
- NEVER CARRY RIDERS.

Safety Labels

- KNOW ALL CONTROLS.
- LATCH BRAKES TOGETHER FOR TRANSPORT AND PARKING.
- BEFORE LEAVING SEAT:
 - LOWER ATTACHMENT / IMPLEMENT
 - LOCK PARK BRAKE.
 - STOP ENGINE AND REMOVE KEY.
- READ OPERATOR'S MANUAL FOR TRAINING.

The emissions warranty described in the warranty section applies only to those engines marketed by John Deere that have been certified by the United States Environmental Protection Agency (EPA) and/or California Air Resources Board (CARB); and used in the United States in non-road mobile (self-propelled or portable/transportable¹) equipment. The presence of an emissions label like the one shown signifies that the engine has been certified with the EPA and/or CARB. The EPA and CARB warranties only apply to new engines having the certification label affixed to the engine and sold as stated above in the geographic areas governed by the regulating agencies.

NOTE: The hp/kW rating on the engine emissions certification label specifies the gross engine hp/kW, which is flywheel power without fan. In most applications this will not be the same rating as the advertised vehicle hp/kW rating.

Warning M159705



M159705

Picture Note: This label is required and installed on machines sold in California. This label may also be installed on machines sold in other locations.

Operation of This Equipment May Create Sparks that Can Start Fires Around Dry Vegetation. A Spark Arrestor May be Required. The Operator Should Contact Local Fire Agencies For Laws or Regulations Relating to Fire Prevention Requirements.

Emission Control System Certification Label

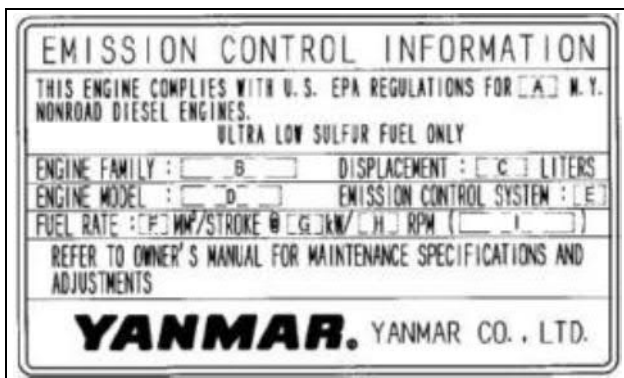

CAUTION: Avoid injury! Statutes providing severe penalties for tampering with emissions controls may apply at the user's location.

¹. Equipment moved at least once every 12 months.

Safety



Recognize Safety Information

This is a safety-alert symbol. When you see this symbol on your machine or in this manual, be alert to the potential for personal injury.

Follow recommended precautions and safe operating practices.

Understand Signal Words

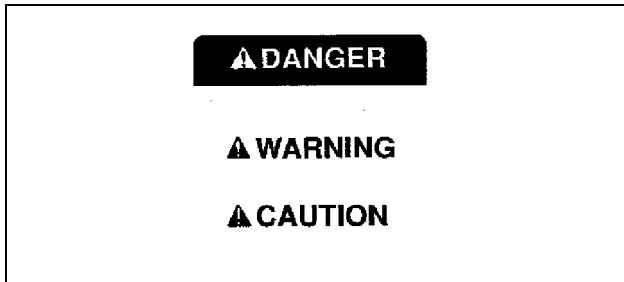

A signal word-DANGER, WARNING, or CAUTION-is used with the safety-alert symbol. DANGER identifies the most serious hazards.

DANGER or WARNING safety signs are located near specific hazards. General precautions are listed on CAUTION safety signs. CAUTION also calls attention to safety messages in this manual.

Follow Safety Instructions

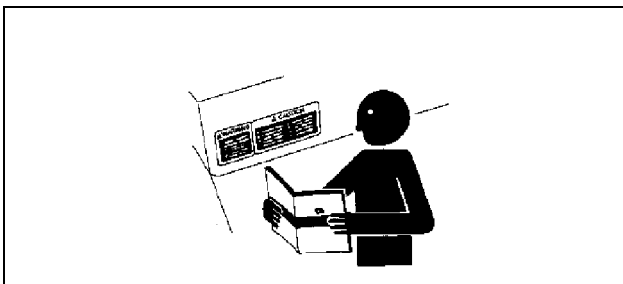

Carefully read all safety messages in this manual and on your machine safety signs. Keep safety signs in good condition. Replace missing or damaged safety signs. Be sure new equipment components and repair parts include the current safety signs. Replacement safety signs are available from your John Deere dealer.

There can be additional safety information contained on parts and components sourced from suppliers that is not reproduced in this operator's manual.

Learn how to operate the machine and how to use controls properly. Do not let anyone operate without instruction.

Keep your machine in proper working condition. Unauthorized modifications to the machine may impair the function and/or safety and affect machine life.

If you do not understand any part of this manual and need assistance, contact your John Deere dealer.

Prepare for Emergencies

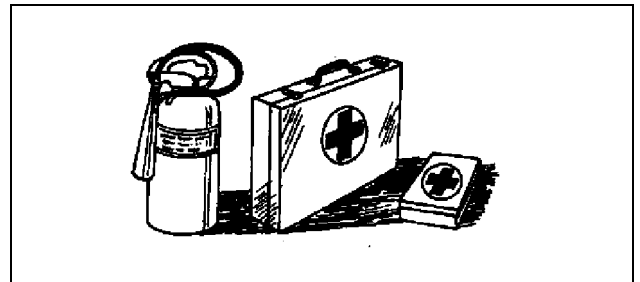

Be prepared if a fire starts.

Keep a first aid kit and fire extinguisher handy.

Keep emergency numbers for doctors, ambulance service, hospital, and fire department near your telephone.

Wear Protective Clothing

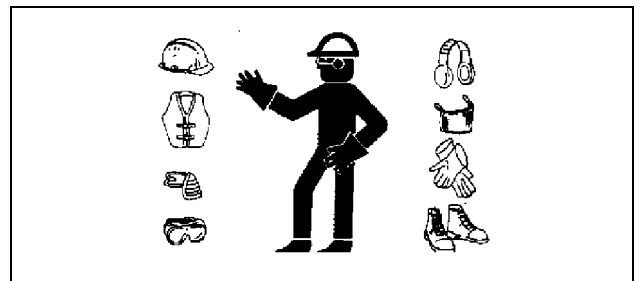

Wear close fitting clothing and safety equipment appropriate to the job.

Operating equipment safely requires the full attention of the operator. Do not wear radio or music headphones while operating machine.

Safety

Protect Against Noise

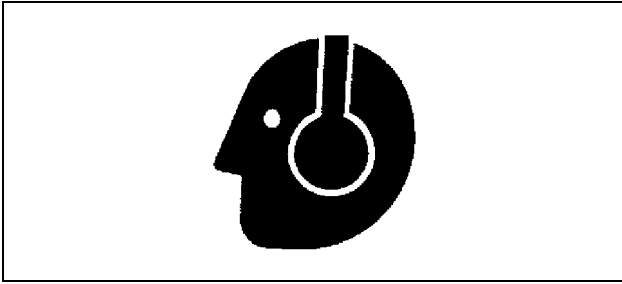

Prolonged exposure to loud noise can cause impairment or loss of hearing.

Wear a suitable hearing protective device such as earmuffs or earplugs to protect against objectionable or uncomfortable loud noises.

Handle Fuel Safely - Avoid Fires

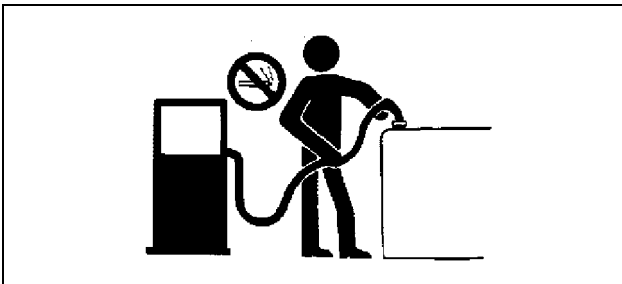

Handle fuel with care: it is highly flammable. Do not refuel the machine while smoking or when near open flame or sparks.

Always stop engine before refueling machine. Fill fuel tank outdoors.

Prevent fires by keeping machine clean of accumulated trash, grease, and debris. Always clean up spilled fuel.

Use only an approved fuel container for transporting flammable liquids.

Never fill fuel container in pickup truck with plastic bed liner. Always place fuel container on ground before refueling. Touch fuel container with fuel dispenser nozzle before removing can lid. Keep fuel dispenser nozzle in contact with fuel container inlet when filling.

Do not store fuel container where there is an open flame spark, or pilot light such as within a water heater or other appliance.

Handle Starting Fluid Safely

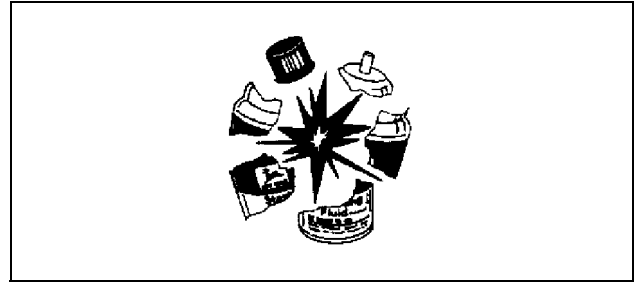

Starting fluid is highly flammable.

Keep all sparks and flame away when using it. Keep starting fluid away from batteries and cables.

To prevent accidental discharge when storing the pressurized can, keep the cap on the container, and store in a cool, protected location.

Do not incinerate or puncture a starting fluid container.

Fire Prevention

To reduce the risk of fire, your tractor should be regularly inspected and cleaned.

- Birds and other animals may build nests or bring other flammable materials into the engine compartment or onto the exhaust system. The tractor should be inspected and cleaned prior to the first use each day.
- A build up of grass, crop material and other debris may occur during normal operation. This is especially true when operating in very dry conditions or conditions where airborne crop material or crop dust is present. Any such build up must be removed to ensure proper machine function and to reduce the risk of fire. The tractor must be inspected and cleaned periodically throughout the day.
- Regular and thorough cleaning of the tractor combined with other routine maintenance procedures listed in the Operator's Manual greatly reduce the risk of fire and the chance of costly downtime.
- Do not store fuel container where there is an open flame, spark, or pilot light such as within a water heater or other appliance.
- Check fuel lines, tank, cap, and fittings frequently for damage, cracks or leaks. Replace if necessary.

Follow all operational and safety procedures posted on the machine and the Operator's Manual. Be careful of hot engine and exhaust components during inspection and cleaning. Before carrying out any inspection or cleaning, always shut OFF the engine, place the transmission in PARK or set parking brake, and remove the key. Removal of the key will prevent others from starting the tractor during

Safety

inspection and cleaning.

Keep ROPS Installed Properly

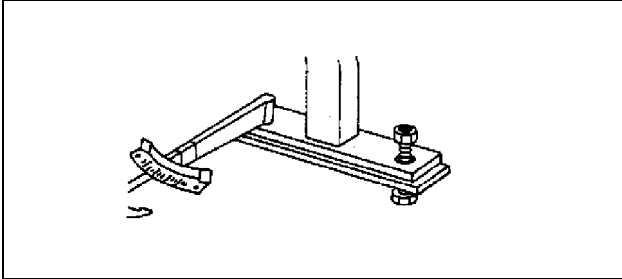

Make certain all parts are reinstalled correctly if the roll-over protective structure (ROPS) is loosened or removed for any reason. Tighten mounting bolts to proper torque.

The protection offered by ROPS will be impaired if ROPS is subjected to structural damage, is involved in an overturn incident, or is in any way altered by welding, bending, drilling, or cutting. A damaged ROPS should be replaced, not reused.

The seat is part of the ROPS safety zone. Replace only with John Deere seat approved for your tractor.

Any alteration of the ROPS must be approved by the manufacturer.

Use Foldable ROPS and Seat Belt Properly

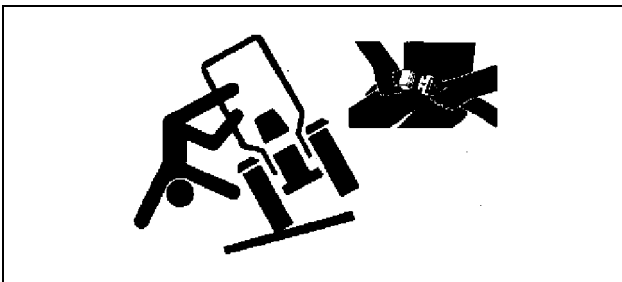

If this tractor is equipped with a foldable ROPS, keep the ROPS in the fully extended and locked position. If the tractor is ever operated with ROPS folded (e.g., to enter a low building), drive with extreme caution. Do NOT use seat belt with the ROPS folded.

Return the ROPS to the raised, fully extended and locked position as soon as the tractor is operated under normal conditions. Always fasten your seat belt when the ROPS is fully extended and locked.

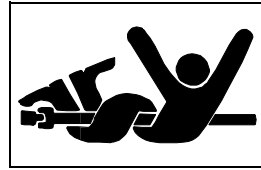

Stay Clear of Rotating Drivelines

Entanglement in rotating driveline can cause serious injury or death.

Keep tractor master shield and driveline shields in place at all times. Make sure rotating shields turn freely.

Wear close fitting clothing. Stop the engine and be sure PTO driveline is stopped before making adjustments, connections, or cleaning out PTO driven equipment.

Do not install any adapter device between the tractor and the primary implement PTO drive shaft that will allow a 1000 rpm tractor shaft to power a 540 rpm implement at speeds higher than 540 rpm.

Do not install any adapter device that results in a portion of the rotating implement shaft, tractor shaft, or the adapter to be unguarded. The tractor master shield shall overlap the end of the splined shaft and the added adaptor device as outlined in the table.

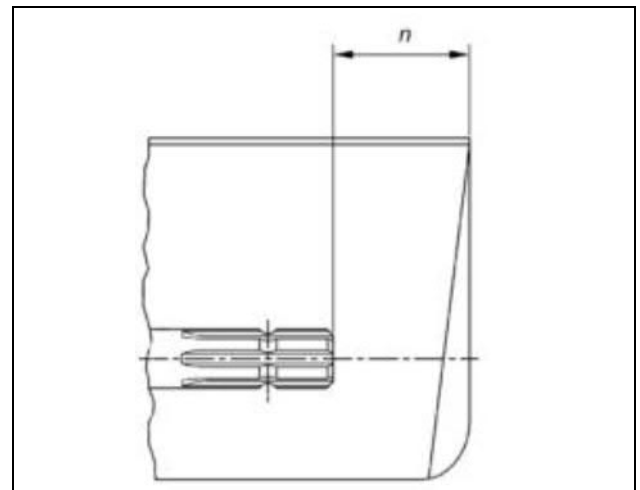

PTO Type	Diameter	Splines	n ± 5mm (0.20 in.)
1	35 mm (1.378 in.)	6	85 mm (3.35 in.)
2	35 mm (1.378 in.)	21	85 mm (3.35 in.)
3	45 mm (1.772 in.)	20	100 mm (4.00 in.)

Safety



Use Steps and Handholds Correctly

Prevent falls by facing the machine when getting on and off. Maintain 3-point contact with steps and handrails. Never use machine controls as handholds.

Use extra care when mud, snow, or moisture present slippery conditions. Keep steps clean and free of grease or oil. Never jump when exiting machine. Never mount or dismount a moving machine.

Read Operator Manuals for ISOBUS Implements

In addition to GreenStar Applications, this display can be used as a display device for any implement that meets ISO 11783 standard. This includes capability to control ISOBUS implements. When used in this manner, information and implement control functions placed on the display are provided by the implement and are the responsibility of the implement manufacturer. Some of these implement functions could provide a hazard either to the Operator or a bystander. Read the operator manual provided by the implements manufacturer and observe all safety messages in manual and on implement prior to use.

NOTE: ISOBUS refers to the ISO Standard 11783.

Use Seat Belt Properly

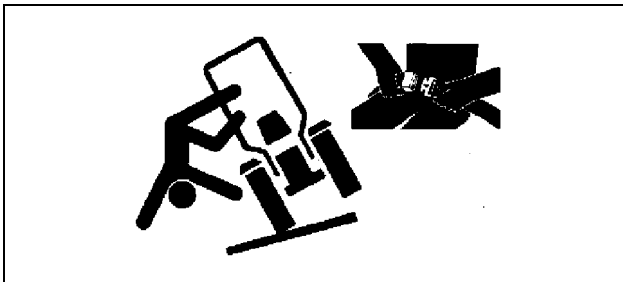

Use a seat belt when you operate with a roll-over protective structure (ROPS) or cab to minimize chance of injury from an accident such as an overturn.

Do not use a seat belt if operating without a ROPS or cab.

Replace entire seat belt if mounting hardware, buckle, belt, or retractor show signs of damage.

Inspect seat belt and mounting hardware at least once a year. Look for signs of loose hardware or belt damage, such as cuts, fraying, extreme or unusual wear, discoloration, or abrasion. Replace only with replacement parts approved for your machine. See your John Deere dealer.

Operating the Tractor Safely



You can reduce the risk of accidents by following these simple precautions:

- Use your tractor only for jobs it was designed to perform, for example, pushing, pulling, towing, actuating, and carrying a variety of interchangeable equipment designed to conduct agricultural work.
- This tractor is not intended to be used as a recreational vehicle.
- Read this operator's manual before operating the tractor and follow operating and safety instructions in the manual and on the tractor.
- Follow operation and ballasting instructions found in the operator's manual for your implements/attachments, such as front loaders
- Make sure that everyone is clear of machine, attached equipment, and work area before starting engine or operation.
- Keep hands, feet, and clothing away from power-driven parts.

Driving Concerns

- Never get on or off a moving tractor.
- Keep all children and nonessential personnel off tractors and all equipment.
- Never ride on a tractor unless seated on a John Deere approved seat with seat belt.
- Keep all shields/guards in place.
- Use appropriate visual and audible signals when operating on public roads.
- Move to side of road before stopping.
- Reduce speed when turning, applying individual brakes,

Safety

or operating around hazards on rough ground or steep slopes.

- Couple brake pedals together for road travel.
- Pump brakes when stopping on slippery surfaces.

Towing Loads

- Be careful when towing and stopping heavy loads. Stopping distance increases with speed and weight of towed loads, and on slopes. Towed loads with or without brakes that are too heavy for the tractor or are towed too fast can cause loss of control.
- Consider the total weight of the equipment and its load.
- Hitch towed loads only to approved couplings to avoid rearward upset.

Parking and Leaving the Tractor

- Before dismounting, shut off SCVs, disengage PTO, stop engine, lower implements/attachments to ground and securely engage park mechanism, including the park pawl and park brake. In addition, if tractor is left unattended, remove key.
- Leaving transmission in gear with engine off will NOT prevent the tractor from moving.
- Never go near an operating PTO or an operating implement.
- Wait for all movement to stop before servicing machinery.

Common Accidents

Unsafe operation or misuse of the tractor can result in accidents. Be alert to hazards of tractor operation.

The most common accidents involving tractors:

- Tractor rollover
- Collisions with motor vehicles
- Improper starting procedures
- Entanglement in PTO shafts
- Falling from tractor
- Crushing and pinching during hitching

Avoid Backover Accidents



Before moving machine, be sure that all persons are clear of machine path. Turn around and look directly for best visibility. Use a signal person when backing if view is obstructed or when in close quarters.

Do not rely on a camera to determine if personnel or obstacles are behind the machine. The system can be limited by many factors including maintenance practices, environmental conditions, and operating range.

Limited Use in Forestry Operation

The intended use of John Deere tractors when used in forestry operations is limited to tractor-specific applications like transport, stationary work such as log splitting, propulsion, or operating implements with PTO, hydraulic, or electrical systems.

These are applications where normal operation does not present a risk of falling or penetrating objects. Any forestry applications beyond these applications, such as forwarding and loading, requires fitment of application-specific components including Falling Object Protective Structure (FOPS) and/or Operative Protective Structures (OPS). Contact John Deere dealer for special components.

Operating the Loader Tractor Safely

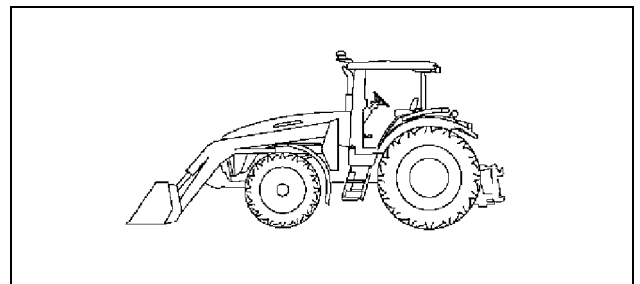

When operating a machine with a loader application,

Safety

reduce speed as required to ensure good tractor and loader stability.

To avoid tractor rollover and damage to front tires and tractor, do not carry load with your loader at a speed over 10 km/h (6 mph).

To avoid tractor damage do not use a front loader or a sprayer tank if the tractor is equipped with a 3 Meter Front Axle.

Never allow anyone to walk or work under a raised loader.

Do not use loader as a work platform.

Do not lift or carry anyone on loader, in bucket, or on implement or attachment.

Lower loader to ground before leaving operators station.

The Rollover Protective Structure (ROPS) or cab roof, if equipped, may not provide sufficient protection from load falling onto the operators station. To prevent loads from falling onto the operators station, always use appropriate implements for specific applications (that is, manure forks, round bale forks, round bale grippers, and clammers).

Keep Riders Off Machine

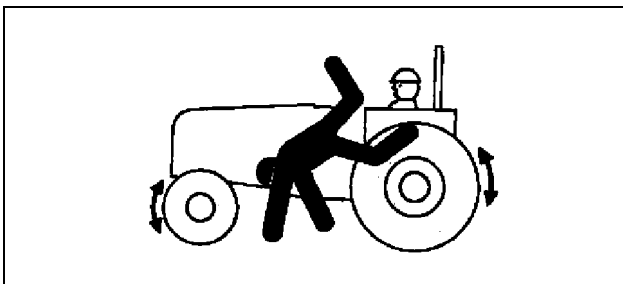

Only allow the operator on the machine. Keep riders off.

Riders on machine are subject to injury such as being struck by foreign objects and being thrown off of the machine. Riders also obstruct the operator's view resulting in the machine being operated in an unsafe manner.

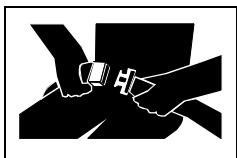

Instructional Seat

The instructional seat, if so equipped, has been provided only for training operators or diagnosing machine problems.

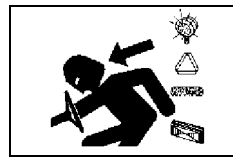

Use Safety Lights and Devices

Prevent collisions between other road users, slow moving tractors with attachments or towed equipment, and self-propelled machines on public roads. Frequently check for traffic from the rear, especially in turns, and use turn signal lights.

Use headlights, flashing warning lights, and turn signals day and night. Follow local regulations for equipment lighting and marking. Keep lighting and marking visible, clean, and in good working order. Replace or repair lighting and marking that has been damaged or lost. An implement safety lighting kit is available from your John Deere dealer.

Use a Safety Chain

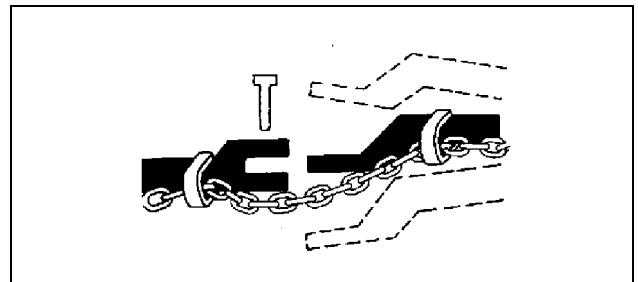

A safety chain will help control drawn equipment should it accidentally separate from the drawbar.

Using the appropriate adapter parts, attach the chain to the tractor drawbar support or other specified anchor location. Provide only enough slack in the chain to permit turning.

See your John Deere dealer for a chain with a strength rating equal to or greater than the gross weight of the towed machine. Do not use safety chain for towing.

Transport Towed Equipment at Safe Speeds

Do not exceed the maximum transport speed. This tractor is capable of operating at transport speeds that exceed the maximum allowable transport speed for most towed implements.

Before transporting a towed implement, determine from signs on the implement or information provided in the implement's operator manual the maximum transport speed. Never transport at speeds that exceed the implement's maximum transport speed. Exceeding the implement's maximum transport speed can result in:

- Loss of control of the tractor/implement combination

Safety

- Reduced or no ability to stop during braking
- Implement tire failure
- Damage to the implement structure or its components

Implements without brakes:

- Do not transport at speeds greater than 32 km/h (20 mph).
- Must weigh less than 1.5 times the tractor weight and less than 1.5 t (3300 lb) when fully loaded.

Implements with brakes:

- If the manufacturer does not specify a maximum transport speed, do not tow at speeds greater than 40 km/h (25 mph).
- When transporting at speeds up to 40 km/h (25 mph) the fully loaded implement must weigh less than 4.5 times the tractor weight.

Use Caution On Slopes and Uneven Terrain

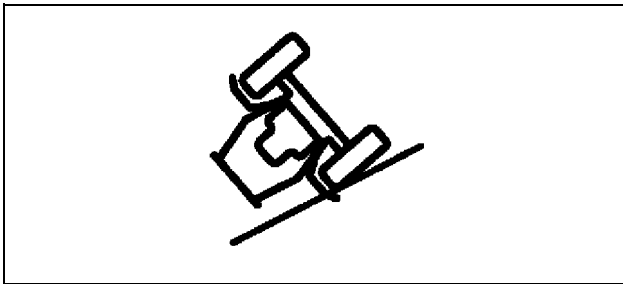

Avoid holes, ditches, and obstructions which cause the tractor to tip, especially on slopes. Avoid sharp uphill turns.

Driving forward out of a ditch, mired condition, or up a steep slope could cause tractor to tip over rearward. Back out of these situations if possible.

Danger of overturn increases greatly with narrow tread setting, at high speed.

Not all conditions that can cause a tractor to overturn are listed. Be alert for any situation in which stability may be compromised.

Slopes are a major factor related to loss-of-control and tip-over accidents, which can result in severe injury or death. Operation on all slopes requires extra caution.

Never drive near the edge of a gully, drop-off, ditch, steep embankment, or a body of water. The machine could suddenly roll over if a wheel goes over the edge or the ground caves in.

Choose a low ground speed so you will not have to stop or shift while on a slope.

Avoid starting, stopping or turning on a slope. If the tires lose traction, disengage the PTO and proceed slowly, straight down the slope.

Keep all movement on slopes slow and gradual. Do not make sudden changes in speed or direction, which could cause the machine to roll over.

Freeing a Mired Machine

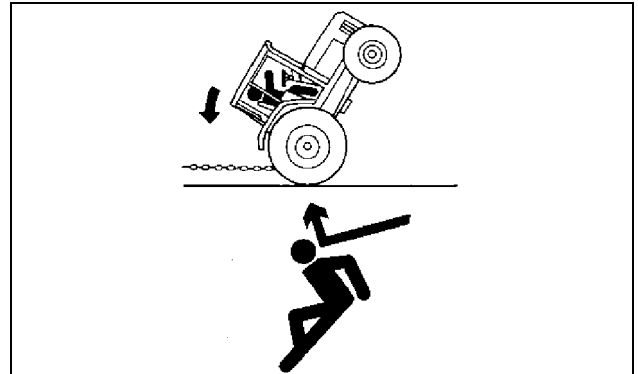

Attempting to free a mired machine can involve safety hazards such as the mired tractor tipping rearward, the towing tractor overturning, and the tow chain or tow bar (a cable is not recommended) failing and recoiling from its stretched condition.

Back your tractor out if it gets mired down in mud. Unhitch any towed implements. Dig mud from behind the rear wheels. Place boards behind the wheels to provide a solid base and try to back out slowly. If necessary, dig mud from the front of all wheels and drive slowly ahead.

If necessary to tow with another unit, use a tow bar or a long chain (a cable is not recommended). Inspect the chain for flaws. Make sure all parts of towing devices are of adequate size and strong enough to handle the load.

Always hitch to the drawbar of the towing unit. Do not hitch to the front pushbar attachment point. Before moving, clear the area of people. Apply power smoothly to take up the slack: a sudden pull could snap any towing device causing it to whip or recoil dangerously.



Suggest:

If the above button click is invalid.

Please download this document

first, and then click the above link

to download the complete manual.

Thank you so much for reading

Safety

Avoid Contact with Agricultural Chemicals

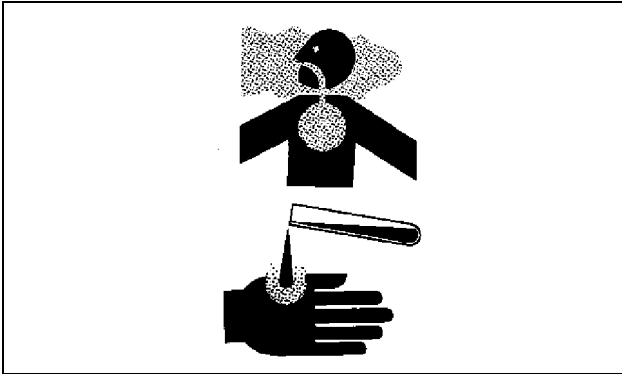

This enclosed cab does not protect against inhaling harmful pesticides. If pesticide use instructions require respiratory protection, wear an appropriate respirator inside the cab.

Before leaving the cab, wear personal protective equipment as required by the pesticide use instructions. When re-entering the cab, remove protective equipment and store either outside the cab in a closed box or some other type of sealable container or inside the cab in a pesticide resistant container, such as a plastic bag.

Clean your shoes or boots to remove soil or other contaminated particles prior to entering the cab.

Handle Agricultural Chemicals Safely

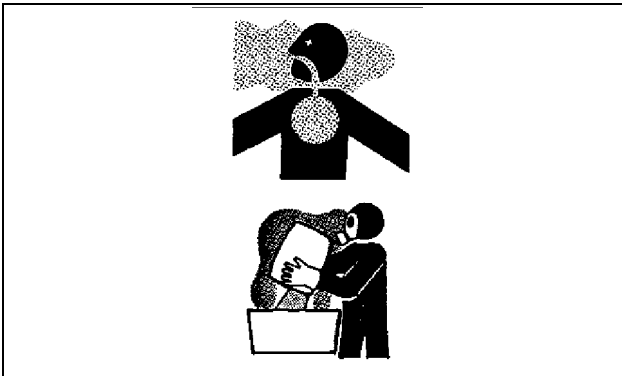

Chemicals used in agricultural applications such as fungicides, herbicides, insecticides, pesticides, rodenticides, and fertilizers can be harmful to your health or the environment if not used carefully.

Always follow all label directions for effective, safe, and legal use of agricultural chemicals.

Reduce risk of exposure and injury:

- Wear appropriate personal protective equipment as recommended by the manufacturer. In the absence of

manufacturer's instructions, follow these general guidelines:

- Chemicals labeled '**Danger**': Most toxic. Generally require use of goggles, respirator, gloves, and skin protection.
- Chemicals labeled '**Warning**': Less toxic. Generally require use of goggles, gloves, and skin protections.
- Chemicals labeled '**Caution**': Least toxic. Generally require use of gloves and skin protection.
- Avoid inhaling vapor, aerosol or dust.
- Always have soap, water, and towel available when working with chemicals. If chemical contacts skin, hands, or face, wash immediately with soap and water. If chemical gets into eyes, flush immediately with water.
- Wash hands and face after using chemicals and before eating, drinking, smoking, or urination.
- Do not smoke or eat while applying chemicals.
- After handling chemicals, always bathe or shower and change clothes. Wash clothing before wearing again.
- Seek medical attention immediately if illness occurs during or shortly after use of chemicals.
- Keep chemicals in original containers. Do not transfer chemicals to unmarked containers or to containers used for food or drink.
- Store chemicals in a secure, locked area away from human or livestock food. Keep children away.
- Always dispose of containers properly. Triple rinse empty containers and puncture or crush containers and dispose of properly.

Handling Batteries Safely

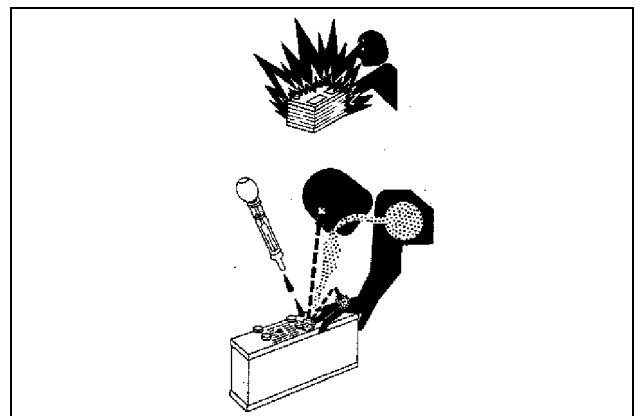

Battery gas can explode. Keep sparks and flames away from batteries. Use a flashlight to check battery electrolyte level.

<https://www.ebooklibonline.com>

Hello dear friend!

Thank you very much for reading.

Enter the link into your browser.

The full manual is available for immediate download.

<https://www.ebooklibonline.com>