

3375 Skid-Steer Loader

(Serial No. 130001 –)

OPERATOR'S MANUAL

**John Deere
Lawn & Grounds Care Division
OMM120644 H5**

North American Version
Litho in U.S.A
English

INTRODUCTION

THANK YOU for purchasing a John Deere product.

Read this manual and your attachment manuals thoroughly. Failure to do so could result in personal injury or equipment damage.



CALIFORNIA
Proposition 65 Warning

Diesel engine exhaust and some of its constituents are known to the State of California to cause cancer, birth defects, and other reproductive harm.

This manual should be considered a permanent part of your machine and should remain with the machine when you sell it.

Measurements in this manual are metric units and their U.S. customary equivalents. RIGHT-HAND and LEFT-HAND sides are determined by facing in the direction the machine will travel when going forward. When you see a broken line arrow (- - - - ->) it indicates the part it is pointing to is hidden.

Record identification numbers below. Be sure to record all the numbers to help in tracing the machine if it is stolen. You also need to give these numbers to your dealer when you order parts.

Date of Purchase:

Dealer Name: _____ **Phone:** _____

Machine Serial Number:
□ □ □ □ □ □ □ □ □ □ □ □ □ □ □ □

Engine Serial Number:
□ □ □ □ □ □ □ □ □ □ □ □ □ □ □ □

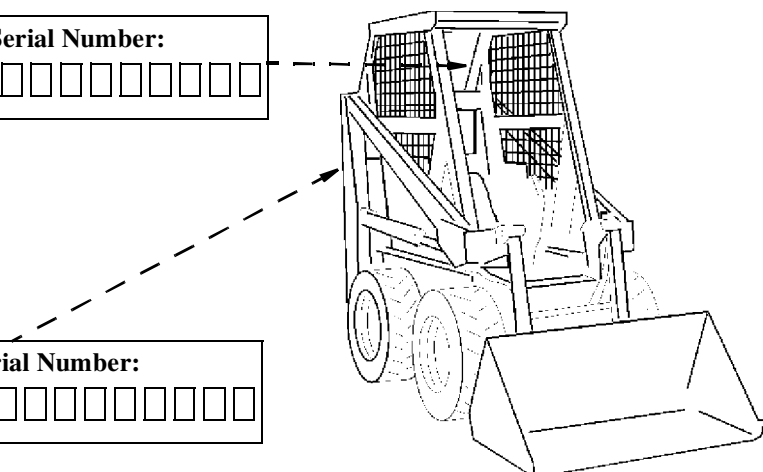

TABLE OF CONTENTS

	Page
Safety Signs	
Safety-Alert Symbol	1
Machine Safety Labels	1
Certification Label	4
Controls	
Hand Controls	5
Foot Controls	6
Instrument Panel	6
Control Panel	7
Indicator Lights	7
Lift Arm Stop Control Lever	8
Operate Safely	
Operator Training Required	9
Use Seat Belt Properly	9
Protect Children	10
Keep Riders Off Machine	10
Park Safely	10
Avoid Tipping	11
Avoid Death	11
Remember The Other Guy	11
Avoid Injury	12
Avoid Hazards	12
Use Handholds And Steps	13
Wear Appropriate Clothing	13
Check Wheel Bolts	13
Prevent Machine Runaway	14
Avoid An Explosion	14
Work In Ventilated Area	14
Transport Safely	15

<https://www.ebooklibonline.com>

Hello dear friend!

Thank you very much for reading.

Enter the link into your browser.

The full manual is available for immediate download.

<https://www.ebooklibonline.com>

TABLE OF CONTENTS

	Page
Operating Engine	
Daily Operating Checklist.....	16
Testing Safety Systems	16
Checking Boom Safety Interlock	20
Starting Engine.....	21
After Starting	24
Warming Engine.....	25
Operating Engine Under Load	26
Stopping Engine.....	26
Operating Loader	
Operate Loader Safely	28
Engine Will Not Start And Boom Will Not Operate.....	29
Using Park Brake	30
Using Traction Drive Lever.....	30
Using Drive Control Levers	30
Using Lift Arm And Bucket Control Pedals.....	31
Using Lift Arm Stop Control Lever.....	32
Driving On A Road	33
Operating Tips.....	33
Digging With Bucket.....	34
Backfilling Or Leveling With Bucket	35
Loading Bucket–Arc Penetration.....	36
Loading Bucket–Step Penetration.....	37
Dumping Bucket.....	38
Parking Loader.....	39
After Operation.....	40
Installing Bucket	
Park Vehicle Safely	41
Avoid High Pressure Fluids.....	41
Installing Bucket.....	42

TABLE OF CONTENTS

	Page
Removing Bucket	
Park Vehicle Safely.....	43
Avoid High Pressure Fluids	43
Removing Bucket.....	44
Service Machine Safely	
Service Machine Safely	45
Wear Appropriate Clothing	46
Handling Waste Product And Chemicals.....	46
Avoid High Pressure Fluids	47
Service Cooling System.....	47
Service Interval Chart	
Service Intervals	48
Hour Meter.....	49
Service Engine And Hydraulics	
Avoid Fumes.....	50
Diesel Engine Oil/Lubricants.....	50
General Purpose Grease.....	51
Hydraulic Oil	51
Checking Engine Oil Level.....	51
Checking Hydraulic Oil Level.....	52
Checking Coolant Level.....	53
Emptying Dust Valve	54
Cleaning Radiator	54
Lubricating Traction Drive Pivot Arm	55
Cleaning Hydraulic System Breathers.....	55
Changing Engine Oil And Filter	56
Cleaning Hydraulic Oil Screen.....	57
Replacing Hydraulic Filter.....	58

TABLE OF CONTENTS

	Page
Service Engine And Hydraulics (Continued)	
Replacing Fuel Filters	59
Replacing Air Cleaner Element	60
Changing Hydraulic Oil	60
Bleeding Fuel System	61
Draining, Flushing, And Filling Cooling System	63
Engine Coolant.....	66
Service - Electrical	
Cleaning Or Replacing Battery.....	67
Checking And Cleaning Battery	67
Checking Battery Electrolyte Level	68
Charging The Battery	70
Charging Rates	71
Using Booster Battery	72
Replacing Fuse	73
Replacing Control Module	74
Service - Miscellaneous	
Metric Bolt And Cap Screw Torque Values	75
Checking Tire Pressure.....	78
Refueling Machine	79
Before Filling Fuel Tank.....	80
Filling Fuel Tank	80
Fuel Specifications	81
Fuel Storage.....	82
Opening Service Door	83
Removing Seat.....	83
Checking And Adjusting Alternator Belt Tension	84
Checking Drive Chain Tension.....	84
Adjusting Chain Tension	85
Tightening Idler Bracket Bolts	86
Tightening Wheel Bolts	86

TABLE OF CONTENTS

	Page
Service - Miscellaneous (Continued)	
Lubricating Lift Arm Pivot Pins	87
Adjusting Lift Arm Stop Linkage.....	88
Adjusting Pedals	88
Adjusting Traction Drive Belt	89
Adjusting Drive Controls	89
Adjusting Steering Controls (Vertical Position)	90
Adjusting Stop Bolts.....	91
Troubleshooting	
Using Troubleshooting Chart	92
Engine	93
Electrical	97
Hydraulics	99
Brakes.....	101
Hydrostatic System.....	102
Storing Loader	
Storing Safety	105
Using Engine Storage Kit.....	105
Storing The Loader	106
Removing Loader From Storage	107
Assembly	
Installing Wheels–Loader On Pallet.....	108
Checking Tire Pressure	109
Specifications	
Engine.....	110
Electrical System	110
Capacities	111
Drive Train	111
Travel Speeds.....	111

TABLE OF CONTENTS

	Page
Specifications (Continued)	
Steering And Brakes	111
Dimensions	112
Tire Air Pressure	112
Performance Ratings Of Vehicle	112
Cycle Times	113
Bucket And Fork Weights.....	113
 Warranty Information	
Product Warranty	114
Tire Warranty	114
Limited Battery Warranty.....	115
 John Deere Service Literature Available	
Order Form.....	117

All information, illustrations and specifications in this manual are based on the latest information at the time of publication. The right is reserved to make changes at any time without notice.

COPYRIGHT© 1995
John Deere Horicon Works
All rights reserved
Previous Editions
COPYRIGHT© 1993

SAFETY SIGNS

Safety-Alert Symbol

Read and recognize safety information. Be alert to the potential for personal injury when you see this safety-alert symbol.



On your machine safety labels, the words DANGER, WARNING, and CAUTION are used with this safety-alert symbol. DANGER identifies the most serious hazards. In this manual, the word CAUTION and this symbol call attention to safety messages.

Machine Safety Labels



SAFETY SIGNS

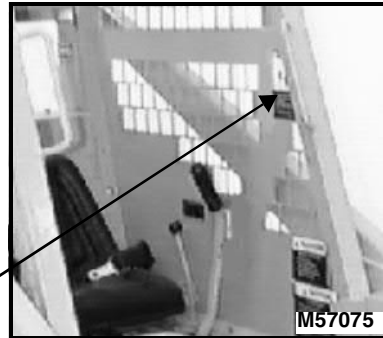

SAFETY SIGNS

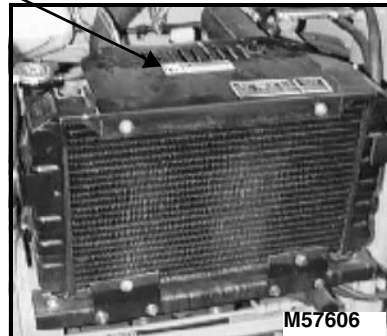

SAFETY SIGNS

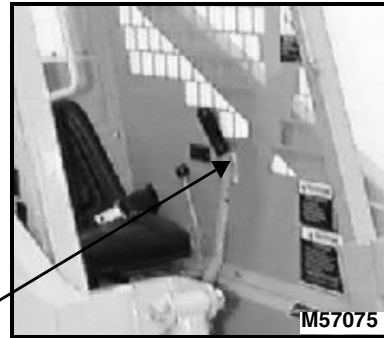

Certification Label

This roll over and falling object protective structure on the John Deere Model 3375 Skid Steer Loader complies with applicable sections of SAE J-1040c and J-1043-85 for 1260 kg (3000 lbs) MAXIMUM VEHICLE WEIGHT.



CONTROLS

Hand Controls

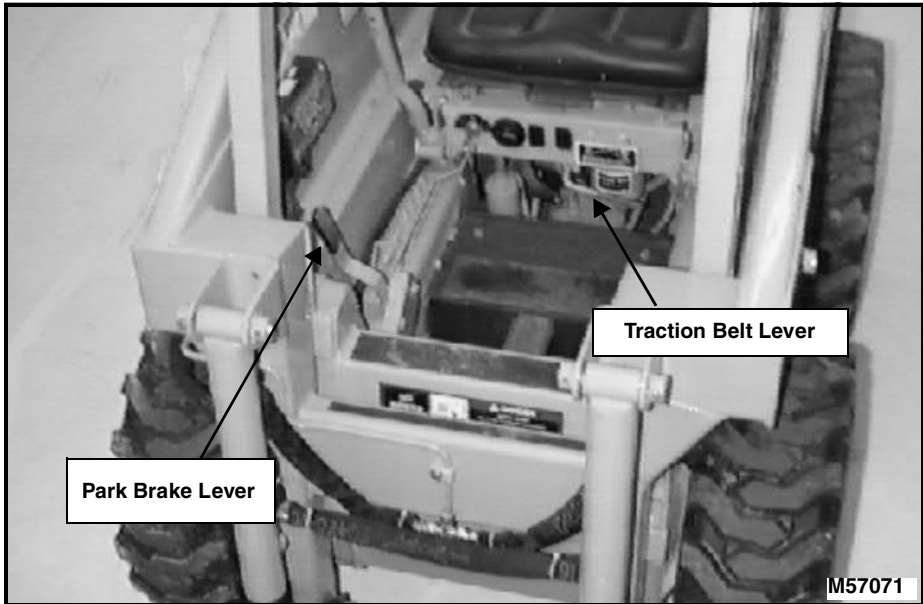
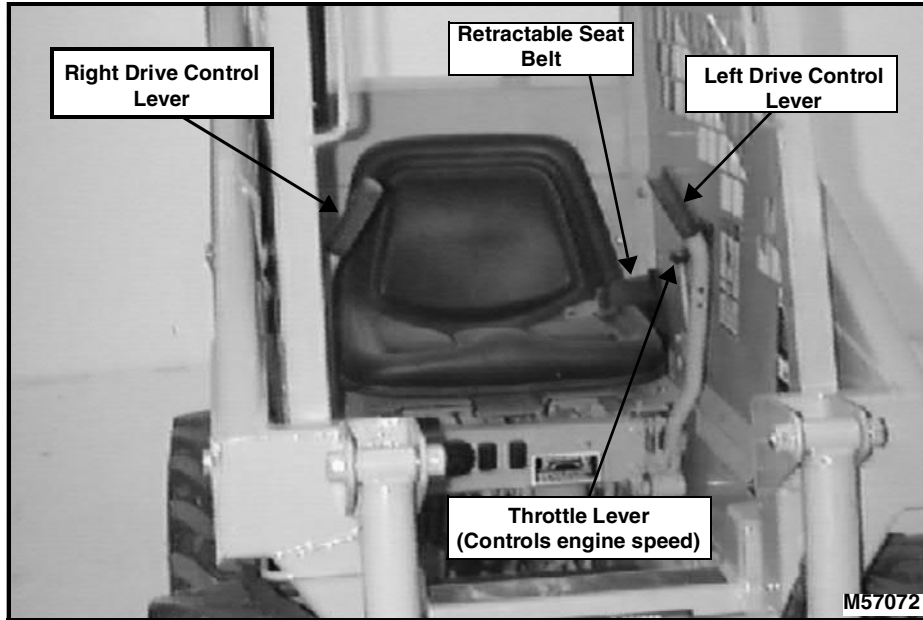

CONTROLS

Foot Controls

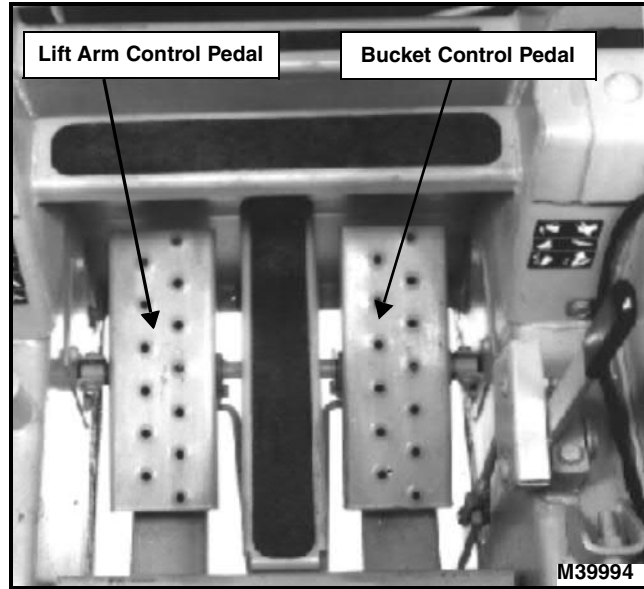

Instrument Panel

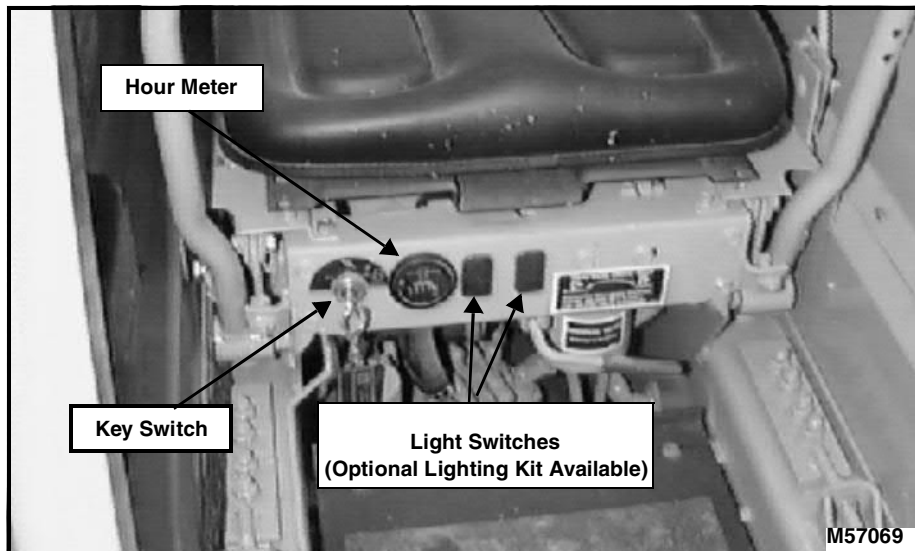

CONTROLS

Control Panel

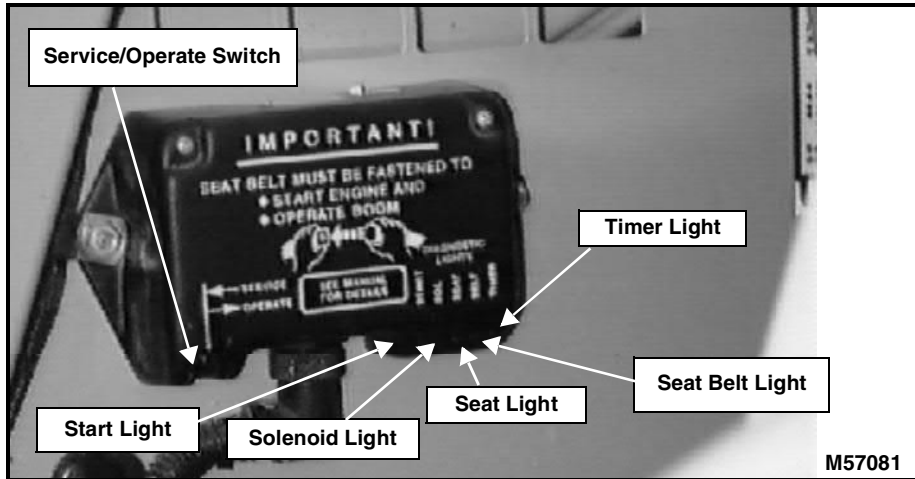

Indicator Lights

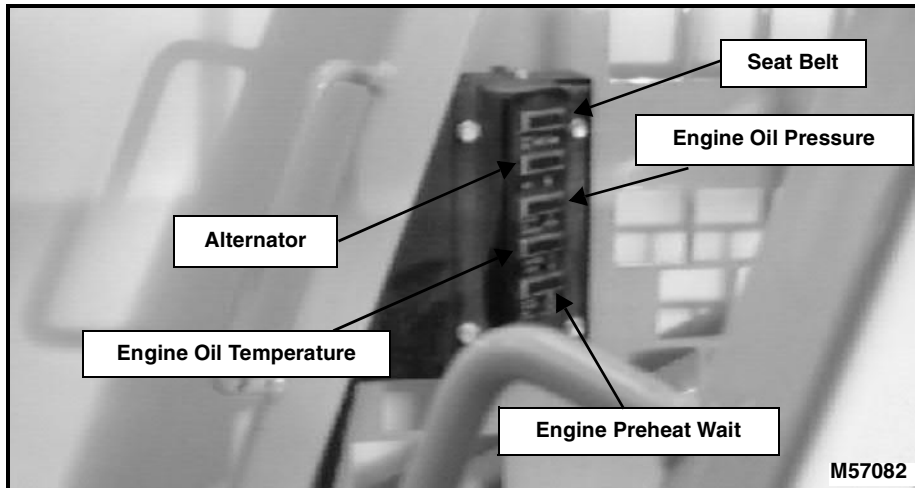

CONTROLS

Lift Arm Stop Control Lever





Suggest:

If the above button click is invalid.

Please download this document

first, and then click the above link

to download the complete manual.

Thank you so much for reading

OPERATE SAFELY

Operator Training Required

- Read operator's manual.
- Know location and function of controls.
- Keep safety devices working.
- Keep screens and windows in place.
- Study operation section of this manual before operating the machine.
- Operate machine in an open, unobstructed area under the direction of an experienced operator.
- Operator experience is required to learn the moving, stopping, turning and other operating characteristics of the machine.



Use Seat Belt Properly

- Use a seat belt when you operate with a roll-over protective structure (ROPS) or cab to minimize chance of injury from an accident such as an overturn.

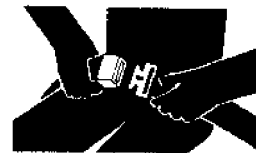

<https://www.ebooklibonline.com>

Hello dear friend!

Thank you very much for reading.

Enter the link into your browser.

The full manual is available for immediate download.

<https://www.ebooklibonline.com>