

JOHN DEERE
AG & TURF DIVISION

Compact Utility Tractor
3320, 3520, 3720

OMLVU26141 F2

OPERATOR'S MANUAL



JOHN DEERE

European Version
Printed in U.S.A.

Introduction

Thank You for Purchasing a John Deere Product

We appreciate having you as a customer and wish you many years of safe and satisfied use of your machine.

Using Your Operator's Manual

This manual is an important part of your machine and should remain with the machine when you sell it.

Reading your operator's manual will help you and others avoid personal injury or damage to the machine. Information given in this manual will provide the operator with the safest and most effective use of the machine. Knowing how to operate this machine safely and correctly will allow you to train others who may operate this machine.

If you have an attachment, use the safety and operating information in the attachment operator's manual along with the machine operator's manual to operate the attachment safely and correctly.

This manual and safety signs on your machine may also be available in other languages (see your authorized dealer to order).

Sections in your operator's manual are placed in a specific order to help you understand all the safety messages and learn the controls so you can operate this machine safely. You can also use this manual to answer any specific operating or servicing questions. A convenient index located at the end of this book will help you to find needed information quickly.

The machine shown in this manual may differ slightly from your machine, but will be similar enough to help you understand our instructions.

RIGHT-HAND and LEFT-HAND sides are determined by facing in the direction the machine will travel when going forward. When you see a broken line (-----), the item referred to is hidden from view.

Before delivering this machine, your dealer performed a predelivery inspection to ensure best performance.

Machine Use

This machine is designed solely for use in customary agricultural use, for park and amenity area maintenance, and for winter work. Use in any other way is considered as contrary to the intended use.

This machine is not intended for use in forestry operations. The operator station does not provide adequate protection to the occupants in that environment.

The cab available from the manufacturer is not designed to provide adequate protection from hazardous substances. The operator must wear appropriate personal protection equipment.

The manufacturer accepts no liability for damage or injury resulting from this misuse, and these risks must be borne solely by the user. Compliance with and strict adherence to the conditions of operation, service and repair as specified by the manufacturer also constitute essential elements for the intended use.

This machine should be operated, serviced and repaired only by persons familiar with all its particular characteristics and acquainted with the relevant safety rules (accident prevention). The accident prevention regulations, all other generally recognized regulations on safety and occupational medicine and the road traffic regulations must be observed at all times.

Setting fuel delivery beyond published factory specifications or otherwise overpowering will result in loss of warranty protection for this machine.

Any arbitrary modifications carried out on this machine will relieve the manufacturer of all liability for any resulting damage or injury.

Special Messages

Your manual contains special messages to bring attention to potential safety concerns, machine damage as well as helpful operating and servicing information. Please read all the information carefully to avoid injury and machine damage.



CAUTION: Avoid injury! This symbol and text highlight potential hazards or death to the operator or bystanders that may occur if the hazards or procedures are ignored.

IMPORTANT: Avoid damage! This text is used to tell the operator of actions or conditions that might result in damage to the machine.

NOTE: General information is given throughout the manual that may help the operator in the operation or service of the machine.

Product Identification

Record Identification Numbers

Compact Utility Tractor

3320, 3520, 3720 Open Station Models- PIN (710001-)

3320, 3520, 3720 Cab Models- PIN (740001-)

If you need to contact an Authorized Service Center for information on servicing, always provide the product model and identification numbers.

You will need to locate the identifications numbers for the product. Record the information in the spaces provided below.

DATE OF PURCHASE:

DEALER NAME:

DEALER PHONE:

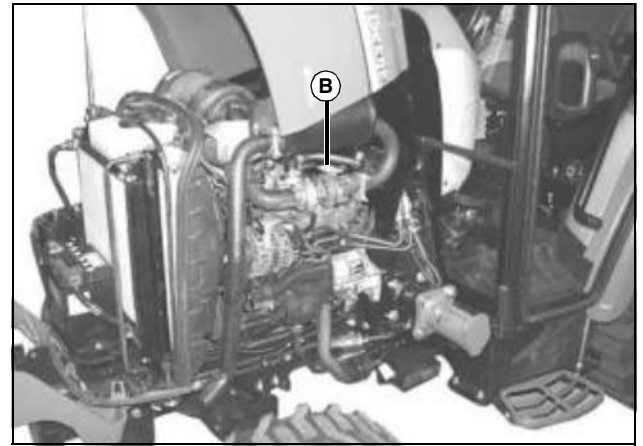

MX35851

ENGINE SERIAL NUMBER (B):



MX35836

PRODUCT IDENTIFICATION NUMBER (A):

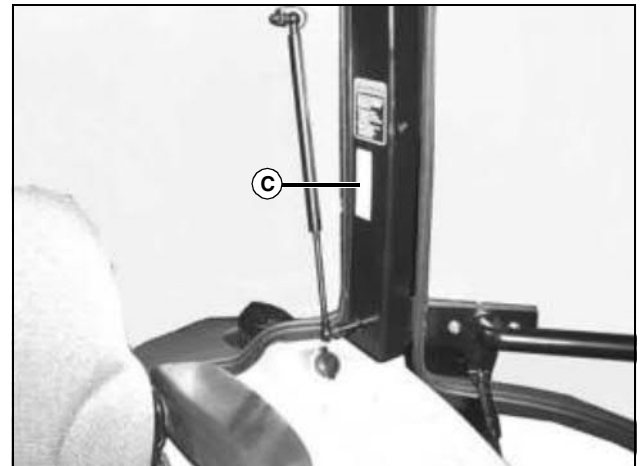

MX35852

CAB SERIAL NUMBER (C):

<https://www.ebooklibonline.com>

Hello dear friend!

Thank you very much for reading.

Enter the link into your browser.

The full manual is available for immediate download.

<https://www.ebooklibonline.com>

Table of Contents

| | |
|---------------------------------|-----|
| Safety Labels | 1 |
| Safety | 5 |
| Operating - Controls | 18 |
| Operating | 22 |
| Replacement Parts | 63 |
| Service Intervals | 64 |
| Service Lubrication | 66 |
| Service Engine | 67 |
| Service Transmission | 79 |
| Service Steering & Brakes | 83 |
| Service Electrical | 85 |
| Service Miscellaneous | 93 |
| Troubleshooting | 101 |
| Storage | 110 |
| Assembly | 111 |
| Specifications | 112 |
| Declaration of Conformity | 121 |
| Index | 122 |

Original Instruction

All information, illustrations and specifications in this manual are based on the latest information at the time of publication. The right is reserved to make changes at any time without notice.

COPYRIGHT© 2012

Deere & Co.

John Deere Ag & Turf Division

All rights reserved

Previous Editions

COPYRIGHT©

OMLVU26141 F2 -

Safety Labels

Safety Label Location

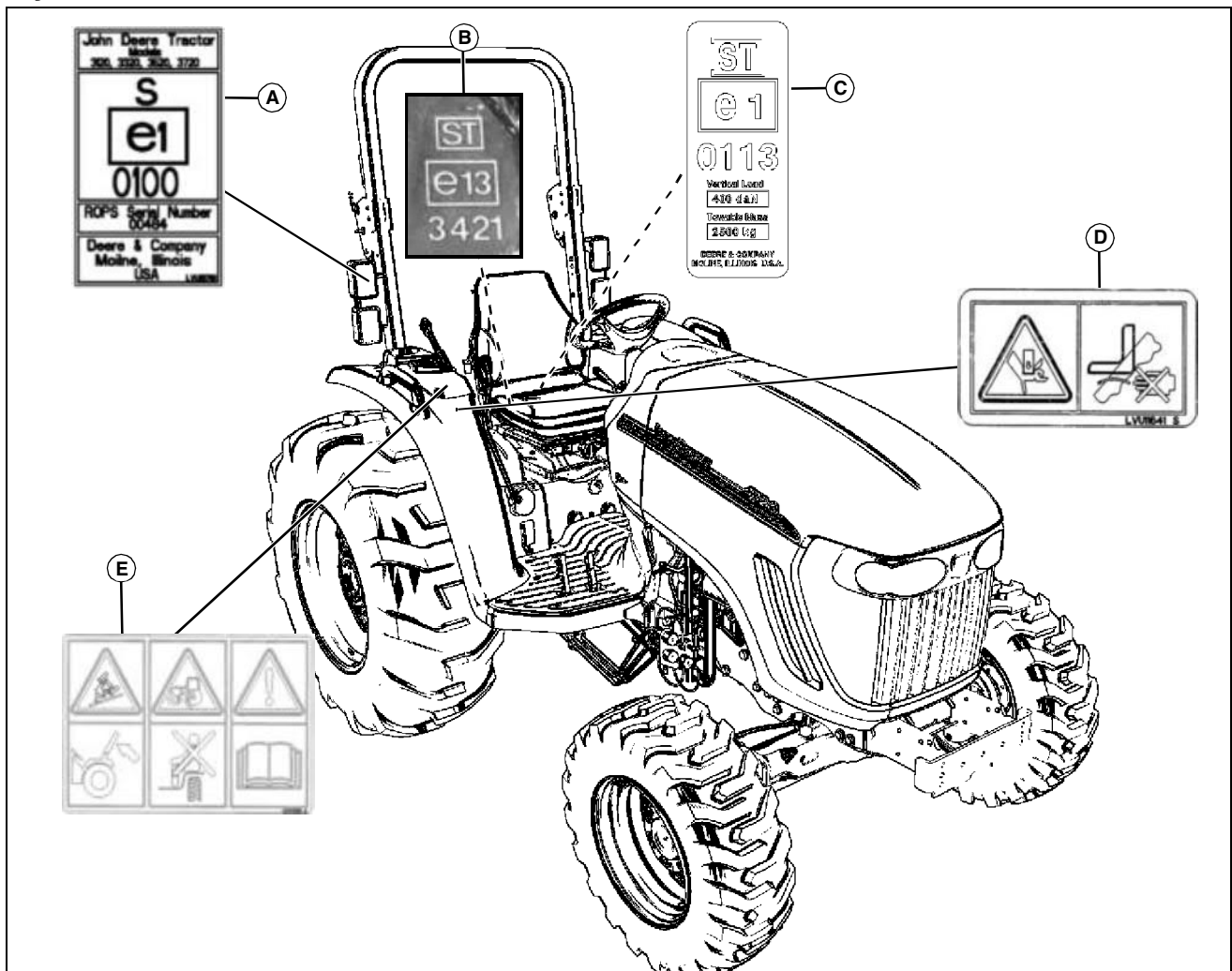

MX40881

Picture Note: Use label number listed in table below to locate complete text of safety label message following this illustration.

- A - ROLL OVER PROTECTION CERTIFICATE PLATE LVU157671**
- B - WAGON HITCH EEC INFORMATION**
- C - DRAWBAR EEC LABEL LVU17318**
- D - CAUTION AVOID CRUSHING LVU11641**
- E - WARNING / CAUTION LVU13286**

Safety Labels

Safety Label Location

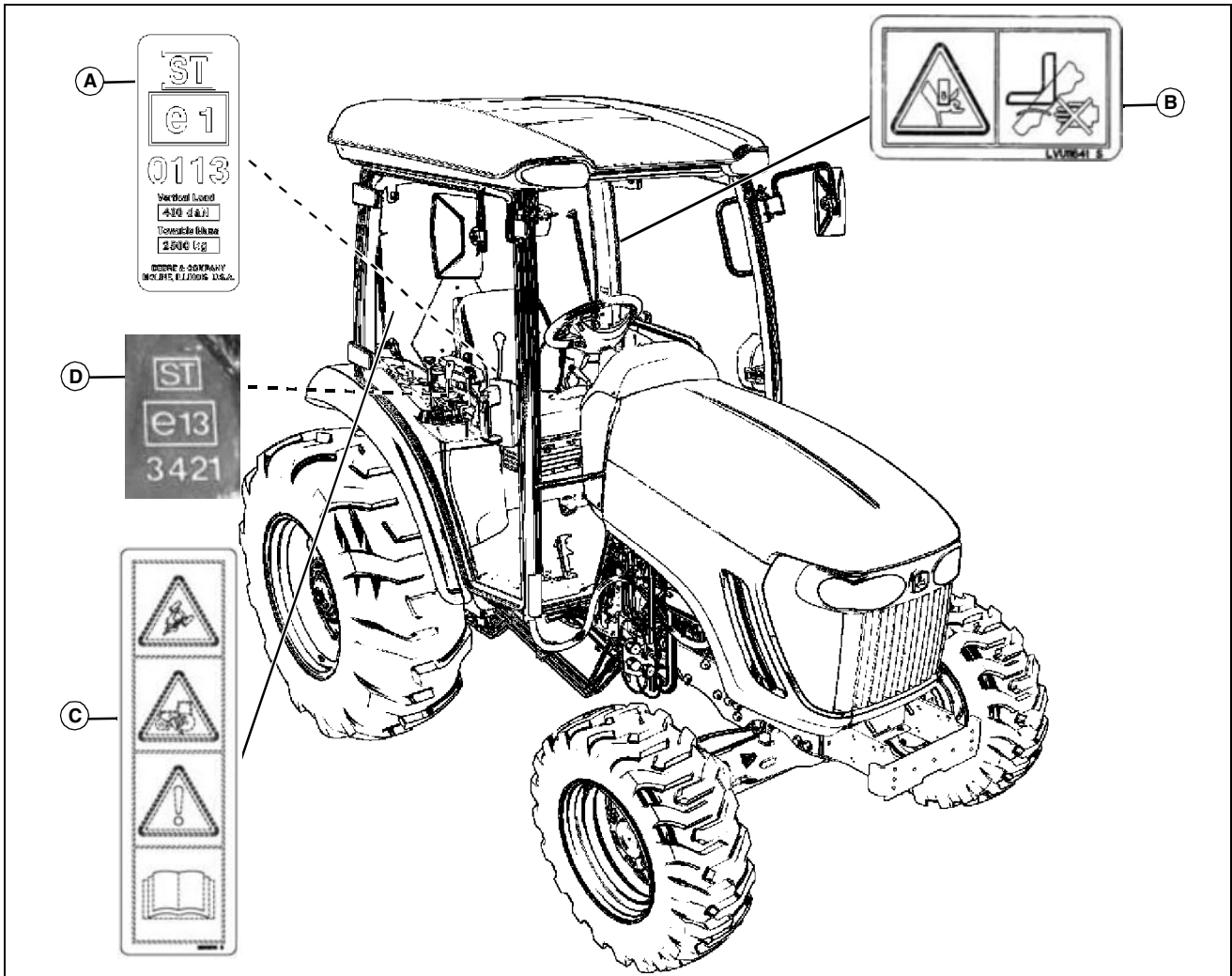

MX40883

Picture Note: Use label number listed in table below to locate complete text of safety label message following this illustration.

- A - DRAWBAR EEC LABEL LVU17318**
- B - CAUTION AVOID CRUSHING LVU11641**
- C - WARNING / CAUTION MIU10773**
- D - WAGON HITCH EEC INFORMATION M72571**

There can be additional safety information contained on parts and components sourced from suppliers that is not reproduced in this operator's manual.



Pictorial Safety Signs

At several important places on this machine safety signs are affixed intended to signify potential danger. The hazard is identified by a pictorial in a warning triangle. An adjacent pictorial provides information how to avoid personal injury. These safety signs, their placement on the machine and a brief explanatory text are shown in this Safety section.

Safety Labels

WARNING KEEP RIDERS OFF - LVU13286



LVU13286

CAUTION KEEP RIDERS OFF

- Only allow the operator on the machine. Keep riders off.
- Riders on the machine may be struck by foreign objects or thrown off the machine causing serious injury.
- Riders obstruct the operator's view resulting in the machine being operated in an unsafe manner.

WARNING AVOID CRUSHING

- Keep Rollover protective Structure fully extended.
- Do not jump if machine tips.
- Use seat belt.
- When structure must be down:
 - Drive with extra care.
 - DO NOT use seat belt.

CAUTION READ OPERATOR'S MANUAL

1. Read Operator's Manual before operating this machine.
2. Keep all shields in place.
3. Hitch towed loads only to drawbar to avoid rearward upset.
4. Make certain everyone is clear of machine before starting engine or operation.
5. Keep all riders off machine and equipment.
6. Keep hands, feet and clothing away from power-driven parts.
7. Reduce speed when turning or applying individual brakes or operating around hazards on rough ground or steep slopes.
8. Couple brake pedals together for road travel.
9. Use flashing warning lights on highway unless prohibited by law.

10. Stop engine, lower implement to ground and shift to "PARK" or set brake(s) securely before dismounting.
11. Wait for all movement to stop before servicing machinery.
12. Remove key if leaving machine unattended.

WARNING / CAUTION - MIU10773

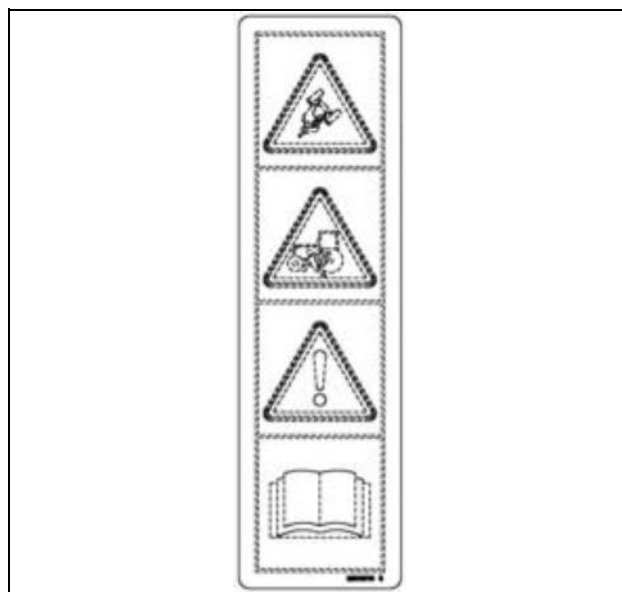

MIU10773

CAUTION KEEP RIDERS OFF

- Only allow the operator on the machine. Keep riders off.
- Riders on the machine may be struck by foreign objects or thrown off the machine causing serious injury.
- Riders obstruct the operator's view resulting in the machine being operated in an unsafe manner.

WARNING AVOID CRUSHING

- Do not jump if machine tips.
- Use seat belt.

CAUTION READ OPERATOR'S MANUAL

1. Read Operator's Manual before operating this machine.
2. Keep all shields in place.
3. Hitch towed loads only to drawbar to avoid rearward upset.
4. Make certain everyone is clear of machine before starting engine or operation.
5. Keep all riders off machine and equipment.
6. Keep hands, feet and clothing away from power-driven parts.

Safety Labels

7. Reduce speed when turning or applying individual brakes or operating around hazards on rough ground or steep slopes.
8. Couple brake pedals together for road travel.
9. Use flashing warning lights on highway unless prohibited by law.
10. Stop engine, lower implement to ground and shift to "PARK" or set brake(s) securely before dismounting.
11. Wait for all movement to stop before servicing machinery.
12. Remove key if leaving machine unattended.

CAUTION AVOID CRUSHING - LVU11641



LVU11641

Keep hands and fingers away from sides of seat backrest and area behind seat. Hands or fingers may be pinched or crushed.

Rollover Protection Certification Plate

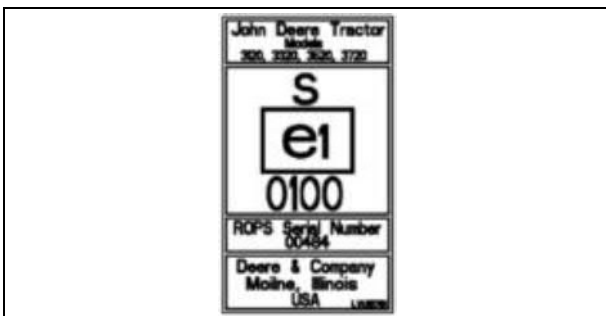

LVU157671

Picture Note: Located on inside of right side ROPS on tractor without cab.

Drawbar EEC Label

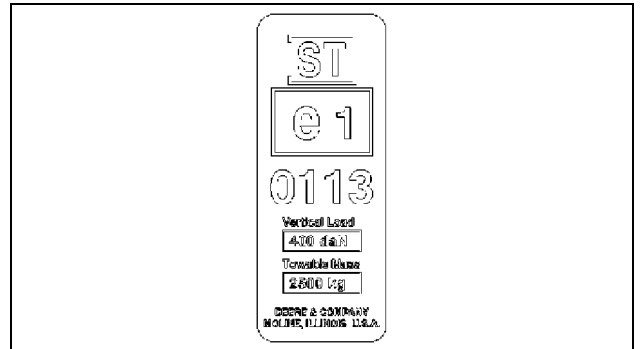

LVU17318

Picture Note: Located on top side of tractor drawbar.

Wagon Hitch EEC Information

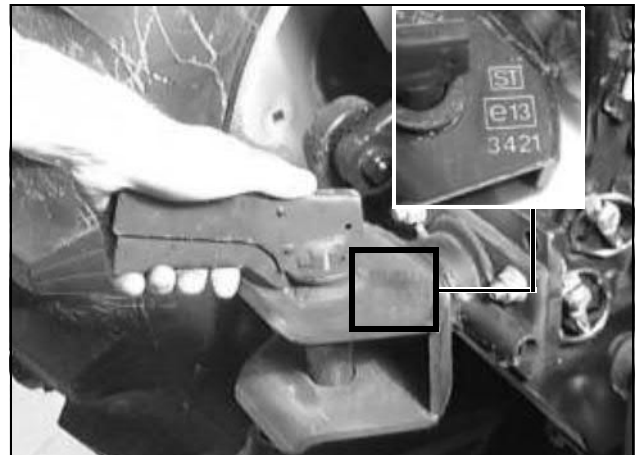

M94510, M72571

Picture Note: Information stamped into top of hitch.

Safety



Recognize Safety Information

This is a safety-alert symbol. When you see this symbol on your machine or in this manual, be alert to the potential for personal injury.

Follow recommended precautions and safe operating practices.

Understand Signal Words

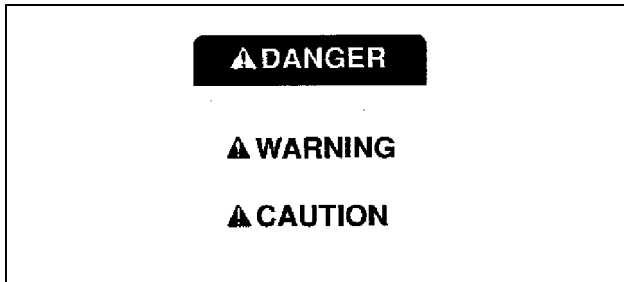

A signal word-DANGER, WARNING, or CAUTION-is used with the safety-alert symbol. DANGER identifies the most serious hazards.

DANGER or WARNING safety signs are located near specific hazards. General precautions are listed on CAUTION safety signs. CAUTION also calls attention to safety messages in this manual.

Follow Safety Instructions

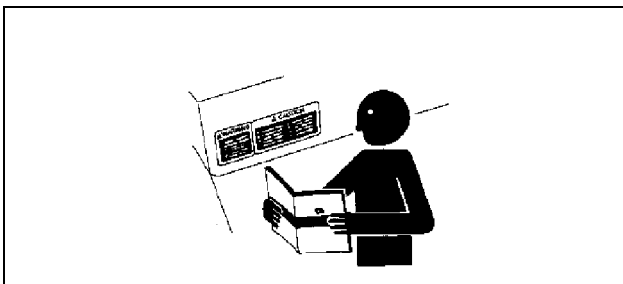

Carefully read all safety messages in this manual and on your machine safety signs. Keep safety signs in good condition. Replace missing or damaged safety signs. Be sure new equipment components and repair parts include the current safety signs. Replacement safety signs are available from your John Deere dealer.

There can be additional safety information contained on parts and components sourced from suppliers that is not reproduced in this operator's manual.

Learn how to operate the machine and how to use controls properly. Do not let anyone operate without instruction.

Keep your machine in proper working condition. Unauthorized modifications to the machine may impair the function and/or safety and affect machine life.

If you do not understand any part of this manual and need assistance, contact your John Deere dealer.

Prepare for Emergencies

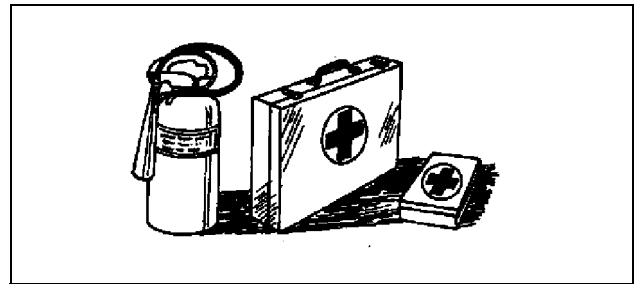

Be prepared if a fire starts.

Keep a first aid kit and fire extinguisher handy.

Keep emergency numbers for doctors, ambulance service, hospital, and fire department near your telephone.

Wear Protective Clothing

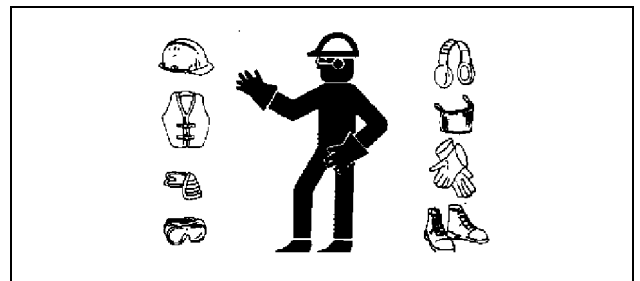

Wear close fitting clothing and safety equipment appropriate to the job.

Operating equipment safely requires the full attention of the operator. Do not wear radio or music headphones while operating machine.

Safety

Protect Against Noise

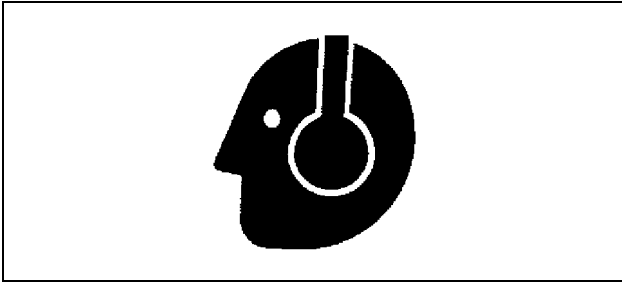

Prolonged exposure to loud noise can cause impairment or loss of hearing.

Wear a suitable hearing protective device such as earmuffs or earplugs to protect against objectionable or uncomfortable loud noises.

Handle Fuel Safely - Avoid Fires



Handle fuel with care: it is highly flammable. Do not refuel the machine while smoking or when near open flame or sparks.

Always stop engine before refueling machine. Fill fuel tank outdoors.

Prevent fires by keeping machine clean of accumulated trash, grease, and debris. Always clean up spilled fuel.

Use only an approved fuel container for transporting flammable liquids.

Never fill fuel container in pickup truck with plastic bed liner. Always place fuel container on ground before refueling. Touch fuel container with fuel dispenser nozzle before removing can lid. Keep fuel dispenser nozzle in contact with fuel container inlet when filling.

Do not store fuel container where there is an open flame spark, or pilot light such as within a water heater or other appliance.

Fire Prevention

To reduce the risk of fire, your tractor should be regularly inspected and cleaned.

- Birds and other animals may build nests or bring other flammable materials into the engine compartment or onto the exhaust system. The tractor should be inspected and cleaned prior to the first use each day.
- A build up of grass, crop material and other debris may occur during normal operation. This is especially true when operating in very dry conditions or conditions where airborne crop material or crop dust is present. Any such build up must be removed to ensure proper machine function and to reduce the risk of fire. The tractor must be inspected and cleaned periodically throughout the day.
- Regular and thorough cleaning of the tractor combined with other routine maintenance procedures listed in the Operator's Manual greatly reduce the risk of fire and the chance of costly downtime.
- Do not store fuel container where there is an open flame, spark, or pilot light such as within a water heater or other appliance.
- Check fuel lines, tank, cap, and fittings frequently for damage, cracks or leaks. Replace if necessary.

Follow all operational and safety procedures posted on the machine and the Operator's Manual. Be careful of hot engine and exhaust components during inspection and cleaning. Before carrying out any inspection or cleaning, always shut OFF the engine, place the transmission in PARK or set parking brake, and remove the key. Removal of the key will prevent others from starting the tractor during inspection and cleaning.

Use Foldable ROPS and Seat Belt Properly

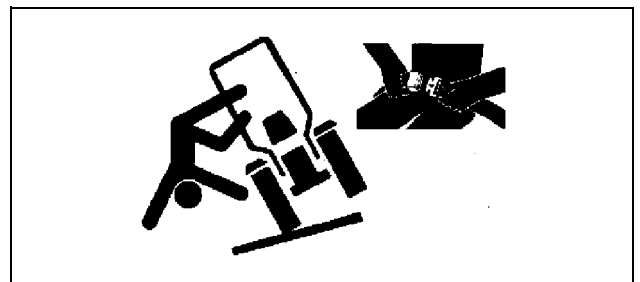

If this tractor is equipped with a foldable ROPS, keep the ROPS in the fully extended and locked position. If the tractor is ever operated with ROPS folded (e.g., to enter a low building), drive with extreme caution. Do NOT use seat belt with the ROPS folded.

Return the ROPS to the raised, fully extended and locked

Safety

position as soon as the tractor is operated under normal conditions. Always fasten your seat belt when the ROPS is fully extended and locked.



Stay Clear of Rotating Drivelines

Entanglement in rotating driveline can cause serious injury or death.

Keep tractor master shield and driveline shields in place at all times. Make sure rotating shields turn freely.

Wear close fitting clothing. Stop the engine and be sure PTO driveline is stopped before making adjustments, connections, or cleaning out PTO driven equipment.

Do not install any adapter device between the tractor and the primary implement PTO drive shaft that will allow a 1000 rpm tractor shaft to power a 540 rpm implement at speeds higher than 540 rpm.

Do not install any adapter device that results in a portion of the rotating implement shaft, tractor shaft, or the adapter to be unguarded. The tractor master shield shall overlap the end of the splined shaft and the added adaptor device as outlined in the table.

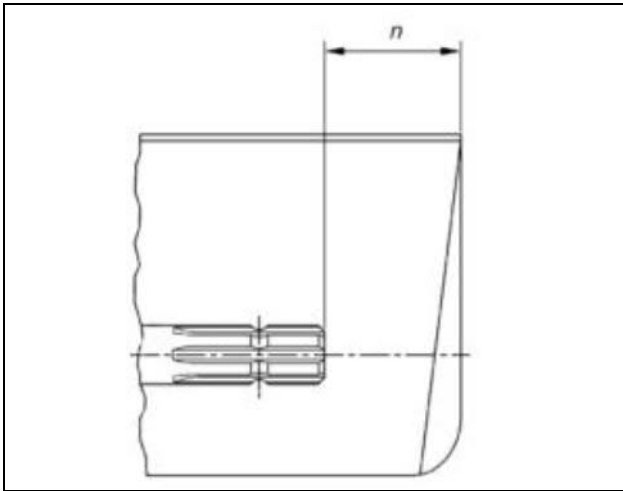

| PTO Type | Diameter | Splines | n ± 5mm (0.20 in.) |
|----------|-------------------|---------|--------------------|
| 1 | 35 mm (1.378 in.) | 6 | 85 mm (3.35 in.) |
| 2 | 35 mm (1.378 in.) | 21 | 85 mm (3.35 in.) |

| PTO Type | Diameter | Splines | n ± 5mm (0.20 in.) |
|----------|-------------------|---------|--------------------|
| 3 | 45 mm (1.772 in.) | 20 | 100 mm (4.00 in.) |

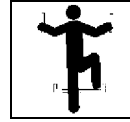

Use Steps and Handholds Correctly

Prevent falls by facing the machine when getting on and off. Maintain 3-point contact with steps and handrails. Never use machine controls as handholds.

Use extra care when mud, snow, or moisture present slippery conditions. Keep steps clean and free of grease or oil. Never jump when exiting machine. Never mount or dismount a moving machine.

Read Operator Manuals for ISOBUS Implements

In addition to GreenStar Applications, this display can be used as a display device for any implement that meets ISO 11783 standard. This includes capability to control ISOBUS implements. When used in this manner, information and implement control functions placed on the display are provided by the implement and are the responsibility of the implement manufacturer. Some of these implement functions could provide a hazard either to the Operator or a bystander. Read the operator manual provided by the implements manufacturer and observe all safety messages in manual and on implement prior to use.

NOTE: ISOBUS refers to the ISO Standard 11783.

Use Seat Belt Properly

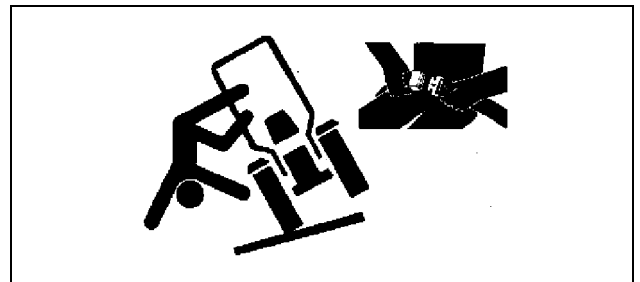

Use a seat belt when you operate with a roll-over protective structure (ROPS) or cab to minimize chance of injury from an accident such as an overturn.

Do not use a seat belt if operating without a ROPS or cab.

Safety

Replace entire seat belt if mounting hardware, buckle, belt, or retractor show signs of damage.

Inspect seat belt and mounting hardware at least once a year. Look for signs of loose hardware or belt damage, such as cuts, fraying, extreme or unusual wear, discoloration, or abrasion. Replace only with replacement parts approved for your machine. See your John Deere dealer.

Vibration

All operator's seats approved by John Deere are component type-approved in accordance with 78/764/EEC, being allocated an average of the vibration acceleration actually measured at the seat (a_{wS}), equivalent to ≤ 1.25 m/s².

This value must NOT be used to calculate vibration stress as per 2002/44/EC! Local John Deere dealers can provide assistance in assessing vibration stress.

Measures to reduce vibration may include:

- Appropriate style of driving, e.g. not too fast
- Suspended front axle
- Suspended cab
- Correctly adjusted operator's seat
- Correct tire pressure

Operating the Tractor Safely



You can reduce the risk of accidents by following these simple precautions:

- Use your tractor only for jobs it was designed to perform, for example, pushing, pulling, towing, actuating, and

carrying a variety of interchangeable equipment designed to conduct agricultural work.

- This tractor is not intended to be used as a recreational vehicle.
- Read this operator's manual before operating the tractor and follow operating and safety instructions in the manual and on the tractor.
- Follow operation and ballasting instructions found in the operator's manual for your implements/attachments, such as front loaders
- Make sure that everyone is clear of machine, attached equipment, and work area before starting engine or operation.
- Keep hands, feet, and clothing away from power-driven parts.

Driving Concerns

- Never get on or off a moving tractor.
- Keep all children and nonessential personnel off tractors and all equipment.
- Never ride on a tractor unless seated on a John Deere approved seat with seat belt.
- Keep all shields/guards in place.
- Use appropriate visual and audible signals when operating on public roads.
- Move to side of road before stopping.
- Reduce speed when turning, applying individual brakes, or operating around hazards on rough ground or steep slopes.
- Couple brake pedals together for road travel.
- Pump brakes when stopping on slippery surfaces.

Towing Loads

- Be careful when towing and stopping heavy loads. Stopping distance increases with speed and weight of towed loads, and on slopes. Towed loads with or without brakes that are too heavy for the tractor or are towed too fast can cause loss of control.
- Consider the total weight of the equipment and its load.
- Hitch towed loads only to approved couplings to avoid rearward upset.

Parking and Leaving the Tractor

- Before dismounting, shut off SCVs, disengage PTO, stop engine, lower implements/attachments to ground and securely engage park mechanism, including the park pawl and park brake. In addition, if tractor is left unattended, remove key.

Safety

- Leaving transmission in gear with engine off will NOT prevent the tractor from moving.
- Never go near an operating PTO or an operating implement.
- Wait for all movement to stop before servicing machinery.

Common Accidents

Unsafe operation or misuse of the tractor can result in accidents. Be alert to hazards of tractor operation.

The most common accidents involving tractors:

- Tractor rollover
- Collisions with motor vehicles
- Improper starting procedures
- Entanglement in PTO shafts
- Falling from tractor
- Crushing and pinching during hitching

Avoid Backover Accidents



Before moving machine, be sure that all persons are clear of machine path. Turn around and look directly for best visibility. Use a signal person when backing if view is obstructed or when in close quarters.

Do not rely on a camera to determine if personnel or obstacles are behind the machine. The system can be limited by many factors including maintenance practices, environmental conditions, and operating range.

Limited Use in Forestry Operation

The intended use of John Deere tractors when used in forestry operations is limited to tractor-specific applications like transport, stationary work such as log splitting, propulsion, or operating implements with PTO, hydraulic, or electrical systems.

These are applications where normal operation does not

present a risk of falling or penetrating objects. Any forestry applications beyond these applications, such as forwarding and loading, requires fitment of application-specific components including Falling Object Protective Structure (FOPS) and/or Operative Protective Structures (OPS). Contact John Deere dealer for special components.

Operating the Loader Tractor Safely

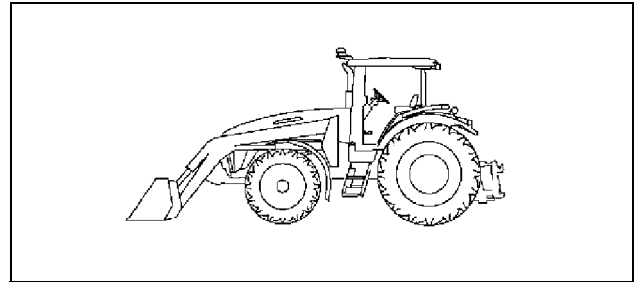

When operating a machine with a loader application, reduce speed as required to ensure good tractor and loader stability.

To avoid tractor rollover and damage to front tires and tractor, do not carry load with your loader at a speed over 10 km/h (6 mph).

To avoid tractor damage do not use a front loader or a sprayer tank if the tractor is equipped with a 3 Meter Front Axle.

Never allow anyone to walk or work under a raised loader.

Do not use loader as a work platform.

Do not lift or carry anyone on loader, in bucket, or on implement or attachment.

Lower loader to ground before leaving operators station.

The Rollover Protective Structure (ROPS) or cab roof, if equipped, may not provide sufficient protection from load falling onto the operators station. To prevent loads from falling onto the operators station, always use appropriate implements for specific applications (that is, manure forks, round bale forks, round bale grippers, and clammers).



Suggest:

If the above button click is invalid.

Please download this document

first, and then click the above link

to download the complete manual.

Thank you so much for reading

Safety

Keep Riders Off Machine

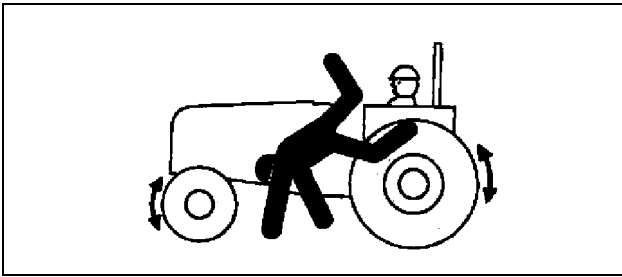

Only allow the operator on the machine. Keep riders off.

Riders on machine are subject to injury such as being struck by foreign objects and being thrown off of the machine. Riders also obstruct the operator's view resulting in the machine being operated in an unsafe manner.

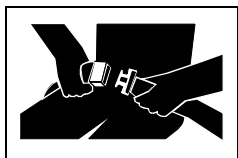
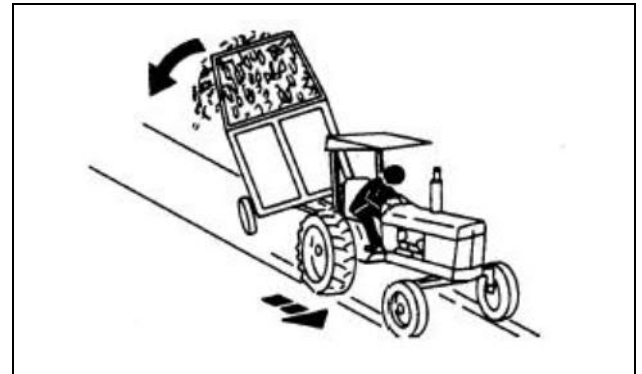

Passenger Seat

The passenger seat is intended only for transport of a passenger in on-road operations (i.e. transport from farm to field).

If it is necessary to transport a passenger, the passenger seat is the only means of transport of a passenger condoned by John Deere.

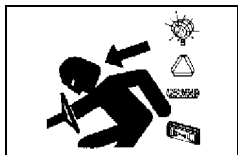

Use Safety Lights and Devices

Prevent collisions between other road users, slow moving tractors with attachments or towed equipment,

and self-propelled machines on public roads. Frequently check for traffic from the rear, especially in turns, and use turn signal lights.

Use headlights, flashing warning lights, and turn signals day and night. Follow local regulations for equipment lighting and marking. Keep lighting and marking visible, clean, and in good working order. Replace or repair lighting and marking that has been damaged or lost. An implement safety lighting kit is available from your John Deere dealer.

Towing Trailers and Implements Safely (Mass)

Stopping distance increases with speed and mass of trailer/ implement, and when transporting on slopes. Towed mass with or without brakes that is too heavy for the tractor or is towed too fast can cause loss of control. Consider the total weight of the equipment and its load.

Trailer/implement brake system

Top speed

| | |
|-----------------------|----------------------|
| unbraked | 25 km/h (15.5 mph) |
| independent | 25 km/h (15.5 mph) |
| overrun brake | 25 km/h (15.5 mph) |
| hydraulic brake | 25 km/h (15.5 mph) |
| single-line air brake | 25 km/h (15.5 mph) |
| dual-line air brake | Maximum design speed |

There may be legal limits in force that restrict travel speeds to figures lower than those quoted here.

Use additional caution when towing loads under adverse surface conditions, when turning, and on includes.

Use Caution On Slopes and Uneven Terrain

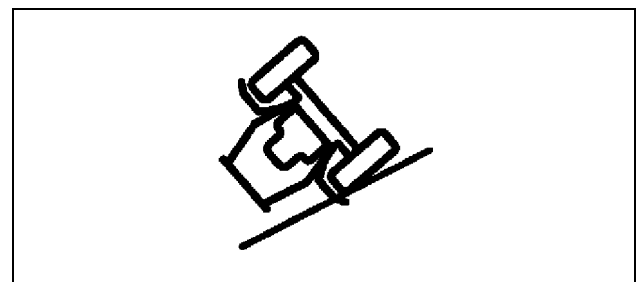

Avoid holes, ditches, and obstructions which cause the tractor to tip, especially on slopes. Avoid sharp uphill turns.

Driving forward out of a ditch, mired condition, or up a steep slope could cause tractor to tip over rearward. Back out of these situations if possible.

Danger of overturn increases greatly with narrow tread setting, at high speed.

<https://www.ebooklibonline.com>

Hello dear friend!

Thank you very much for reading.

Enter the link into your browser.

The full manual is available for immediate download.

<https://www.ebooklibonline.com>