

# 3150 Tractor

## TECHNICAL MANUAL

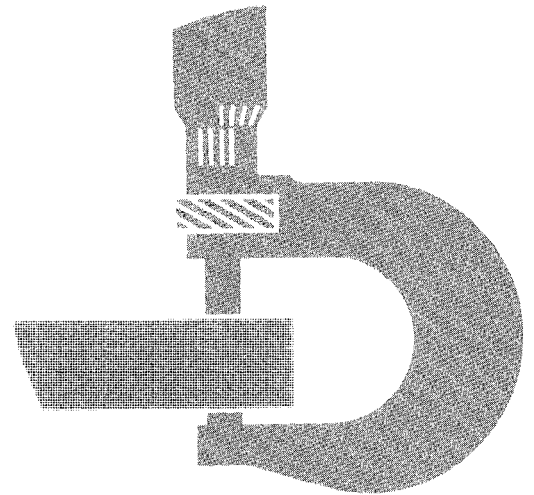



# 3150 TRACTOR TECHNICAL MANUAL TM-4410

## SECTION CONTENTS IN GROUPS – REPAIR

### 10 – GENERAL

- 05 – Specifications
- 10 – Pre-delivery, delivery and after-sales inspections
- 15 – Lubrication and service
- 20 – Tune-up
- 25 – Tractor separation

### 20 – ENGINE

- 05 – Radiator

### 30 – FUEL AND AIR INTAKE SYSTEM

- 05 – Fuel tank, auxiliary tank and water trap
- 10 – Cold weather starting aids
- 15 – Speed control linkage
- 20 – Air filter

### 40 – ELECTRICAL SYSTEM

- 05 – Wiring harnesses
- 10 – Controls and instruments
- 15 – Lighting system
- 20 – Starting motor
- 25 – Alternator

### 50 – POWER TRAIN

- 05 – Clutch operating linkage
- 10 – Engine clutch
- 15 – Hi-Lo shift unit
- 20 – Transmission shift linkage
- 25 – Synchronized transmission and transmission oil pump
- 30 – Differential

- 35 – Final drives
- 40 – PTO
- 45 – Front PTO
- 50 – Front wheel drive u.j. drive shaft and disk clutch

### 60 – STEERING SYSTEM AND BRAKES

- 05 – Hydrostatic steering
- 10 – Hydraulic brakes
- 15 – Handbrake

### 70 – HYDRAULIC SYSTEM

- 05 – Valves
- 10 – Hydraulic pumps
- 15 – Rockshaft
- 20 – Front hitch
- 25 – Selective control valves (poppet valve type)
- 30 – ISO breakaway couplers
- 35 – Remote cylinder

### 80 – MISCELLANEOUS

- 05 – Front and rear wheels

### 90 – OPERATOR'S STATION

- 05 – Air conditioning system
- 10 – Cab ventilation and heating
- 15 – Operator's seat
- 20 – SOUND-GARD body
- 25 – FOUR-POST ROLL GARD

© by Deere & Co., European Office,  
D-6800 Mannheim

INHALT-LA901AE-020186

## SECTION CONTENTS IN GROUPS – OPERATION AND TESTS

### 220 – ENGINE

- 05 – Radiator
- 10 – Tests

### 230 – FUEL AND AIR INTAKE SYSTEM

- 05 – Fuel tank, auxiliary tank and water trap
- 10 – Cold weather starting aids
- 15 – Speed control linkage
- 20 – Air filter

### 240 – ELECTRICAL SYSTEM

- 05 – Operation, diagnosing malfunctions, wiring diagrams
- 10 – Testing circuits and components
- 15 – Lighting system
- 20 – Starting motor
- 25 – Alternator

### 250 – POWER TRAIN

- 05 – Clutch operating linkage
- 10 – Engine clutch
- 15 – Hi-Lo shift unit
- 20 – Transmission shift linkage
- 25 – Synchronized transmission and transmission oil pump
- 30 – Differential
- 35 – Final drives
- 40 – Independent PTO
- 45 – Front PTO
- 50 – Front wheel drive u.j. drive shaft and disk clutch

### 260 – STEERING SYSTEM AND BRAKES

- 05 – Hydrostatic steering
- 10 – Hydraulic brakes
- 15 – Handbrake

### 270 – HYDRAULIC SYSTEM

- 05 – Operation and tests
- 10 – Hydraulic pumps
- 15 – Rockshaft
- 20 – Front hitch
- 25 – Selective control valves (poppet valve type)
- 30 – ISO breakaway couplers
- 35 – Remote cylinder

### 290 – OPERATOR'S STATION

- 05 – Air conditioning system
- 10 – Cab ventilation and heating

INHALT-LA902AE-020186

**<https://www.ebooklibonline.com>**

Hello dear friend!

Thank you very much for reading.

Enter the link into your browser.

The full manual is available for immediate download.

**<https://www.ebooklibonline.com>**

# Group 10 GENERAL

## CONTENTS OF THIS SECTION IN GROUPS

### 05 – SPECIFICATIONS

Specifications .....	10-05-1
– Serial number plates .....	10-05-1
– Product identification number .....	10-05-1
– Engine serial number .....	10-05-1
– Transmission serial number .....	10-05-1
– Front wheel drive serial number .....	10-05-2
– SOUND-GARD Body serial number .....	10-05-2
– ROLL-GARD serial number .....	10-05-2
– Model serial numbers .....	10-05-3
– Engine .....	10-05-4
– Engine clutch .....	10-05-5
– Cooling system .....	10-05-5
– Fuel system .....	10-05-5
– Electrical system .....	10-05-5
– Synchronized transmission .....	10-05-5
– Hi-Lo shift unit .....	10-05-5
– Differential and final drives .....	10-05-6
– Differential lock .....	10-05-6
– PTO .....	10-05-6
– Front PTO .....	10-05-6
– PTO speeds .....	10-05-6
– Front wheel drive .....	10-05-7
– Hydrostatic steering .....	10-05-7
– Foot brakes .....	10-05-7
– Hand brake .....	10-05-7
– Hydraulic system .....	10-05-7
– Rockshaft .....	10-05-7
– Front hitch .....	10-05-7
– Ground travel speeds .....	10-05-7
– Front and rear wheels .....	10-05-8
– Dimensions and weights .....	10-05-8
– Capacities .....	10-05-8
– Standard torques for hardware .....	10-05-8

### 10 – PREDELIVERY, DELIVERY AND AFTER-SALES INSPECTIONS

Special tools .....	10-10-1
Specifications .....	10-10-2
Capacities .....	10-10-3
Torques for hardware .....	10-10-3
Predelivery inspection .....	10-10-4
Delivery inspection .....	10-10-20
After-sales inspection .....	10-10-21

### 15 – LUBRICATION AND SERVICE

Specifications .....	10-15-1
Capacities .....	10-15-1
Service intervals .....	10-15-1
Lubrication and service intervals .....	10-15-2
Capacities and service period .....	10-15-3
General .....	10-15-4
Engine oil .....	10-15-4
Transmission/hydraulic oil .....	10-15-5
Oil for mechanical front wheel drive .....	10-15-5
EP multi-purpose grease .....	10-15-6
Storing lubricants .....	10-15-6
Brake fluid for clutch operating system .....	10-15-6
Engine coolant .....	10-15-7
Checking engine oil level .....	10-15-7
Changing engine oil .....	10-15-8
Changing engine oil filter .....	10-15-8
Checking fuel filter .....	10-15-9
Replacing fuel filter .....	10-15-9
Replacing coolant .....	10-15-10
Checking transmission/hydraulic system oil level .....	10-15-11
Changing transmission/hydraulic oil .....	10-15-12
Replacing transmission/hydraulic oil filter element .....	10-15-13

ALLGEM-LA91001AE-091285

**CONTENTS OF THIS SECTION IN GROUPS**

**15 – LUBRICATION AND SERVICE (Contd.)**

Cleaning hydraulic pump filter  
strainer ..... 10-15-13  
Replacing brake fluid for clutch  
operating system ..... 10-15-13  
Checking axle housing oil level ..... 10-15-14  
Checking oil level in wheel hub  
 housings ..... 10-15-14  
Changing axle housing oil ..... 10-15-14  
Changing wheel hub housing oil ..... 10-15-14  
Cleaning lubricating points ..... 10-15-15  
Lubricating universal-jointed  
drive shaft ..... 10-15-15  
Lubricating front axle carrier ..... 10-15-15  
Lubricating oscillating support ..... 10-15-15  
Lubricating front wheel drive axle ..... 10-15-16  
Lubricating three-point hitch ..... 10-15-16  
Lubricating rear axle bearings ..... 10-15-16  
Lubricating front hitch ..... 10-15-16

**20 – TUNE-UP**

Specifications ..... 10-20-1  
Preliminary engine testing ..... 10-20-2  
Checking air cleaner element ..... 10-20-3  
Checking air intake system connections  
for leaks ..... 10-20-3  
Checking crankcase vent tube for  
clogging ..... 10-20-3  
Cleaning radiator side panels and  
grille screens ..... 10-20-3  
Cleaning radiator and oil cooler ..... 10-20-4  
Cleaning condenser ..... 10-20-4  
Checking radiator cap ..... 10-20-4  
Checking radiator for leaks ..... 10-20-4  
Checking thermostats ..... 10-20-5  
Checking fuel transfer pump ..... 10-20-5  
Checking fuel filter ..... 10-20-5  
Checking fuel tank ..... 10-20-6  
Checking auxiliary fuel tank ..... 10-20-6  
Cleaning water trap ..... 10-20-6  
Checking fuel injection pump  
adjustment ..... 10-20-6  
Checking engine slow and fast  
idle speeds ..... 10-20-7  
Checking speed control linkage  
adjustment ..... 10-20-7  
Checking batteries ..... 10-20-7  
Checking fan belt tension ..... 10-20-8  
Checking compressor belt tension ..... 10-20-8

Checking lighting system ..... 10-20-8  
Checking operation of start safety  
switch ..... 10-20-8  
Checking operation of starting  
motor ..... 10-20-9  
Final engine check ..... 10-20-9  
Checking tractor operation ..... 10-20-9

**25 – TRACTOR SEPARATION**

Special tools ..... 10-25-1  
Torques for hardware ..... 10-25-5  
Capacities ..... 10-25-7  
Standard torques for hardware ..... 10-25-7  
Important notes ..... 10-25-9  
Removing tractor front end ..... 10-25-10  
Installing tractor front end ..... 10-25-17  
Separating between engine and clutch  
housing ..... 10-25-19  
Joining tractor between engine  
and clutch housing ..... 10-25-27  
Removing engine ..... 10-25-30  
Installing engine ..... 10-25-31  
Removing clutch housing ..... 10-25-32  
Installing clutch housing ..... 10-25-33  
Removing transmission ..... 10-25-34  
Installing transmission ..... 10-25-40  
Removing final drives ..... 10-25-44  
Installing final drives ..... 10-25-52  
Removing rockshaft ..... 10-25-55  
Installing rockshaft ..... 10-25-57  
Removing front wheel drive axle ..... 10-25-59  
Installing front wheel drive axle ..... 10-25-61  
Removing SOUND-GARD Body or  
ROLL-GARD ..... 10-25-64  
Installing SOUND-GARD Body or  
Roll-Gard ..... 10-25-74  
Removing front hitch ..... 10-25-77  
Installing front hitch ..... 10-25-80  
Removing front PTO ..... 10-25-82  
Installing front PTO ..... 10-25-84

## SPECIFICATIONS

### SERIAL NUMBER PLATES

The following illustrations show the serial number plates for tractor major components. The letters and figures on these plates are required for warranty claims and when ordering replacement parts.

TECHDA-LA71005AE-180385

### PRODUCT IDENTIFICATION NUMBER

The product identification number plate is located on right-hand side of front axle carrier. The chassis number is stamped in front axle carrier next to the number plate.

*NOTE: When ordering tractor parts (excluding engine parts), quote all letters and figures of serial number stamped on this plate.*

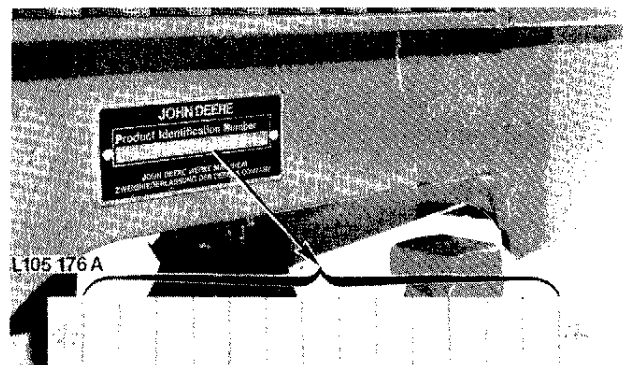

L105176A-LA91005AE-051185

### ENGINE SERIAL NUMBER

The engine serial number plate is located on right-hand side of engine block.

*NOTE: When ordering engine parts, quote all figures on this plate.*

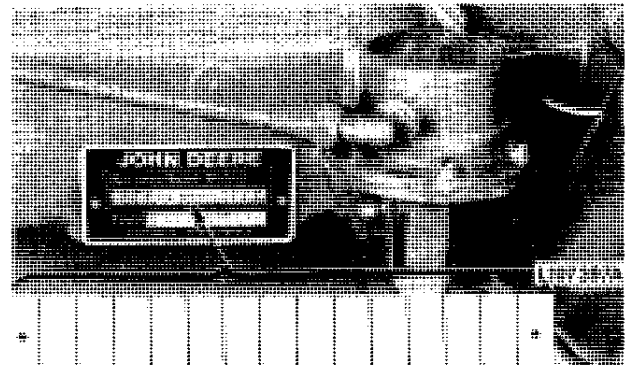

L107397A-LA91005AE-030386

### TRANSMISSION SERIAL NUMBER (Tractors with SOUND-GARD Body)

The transmission serial number plate is located on right-hand crossmember of SOUND-Gard Body and on right-hand side of transmission case.

*NOTE: In addition to serial number of transmission and transmission type, this serial number plate also specifies differential and front wheel drive gear ratios.*

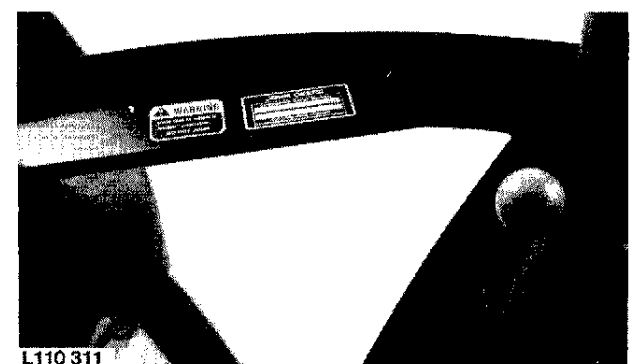

L110311-LA91005AE-030386

## Specifications

### TRANSMISSION SERIAL NUMBER (Tractors with ROLL-GARD)

The transmission serial number plate is located next to the right-hand side of shift console and on right-hand side of transmission case.

*NOTE: In addition to serial number of transmission and transmission type, this serial number plate also specifies differential and front wheel drive gear ratios.*

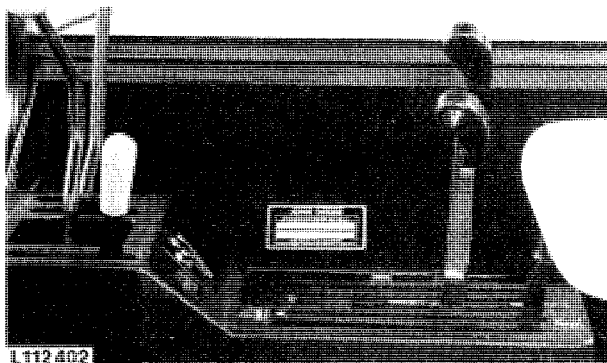

L112402-LA91005AE-051185

### FRONT WHEEL DRIVE AXLE SERIAL NUMBER

The front wheel drive axle serial number plate is located on rear of right-hand axle half.

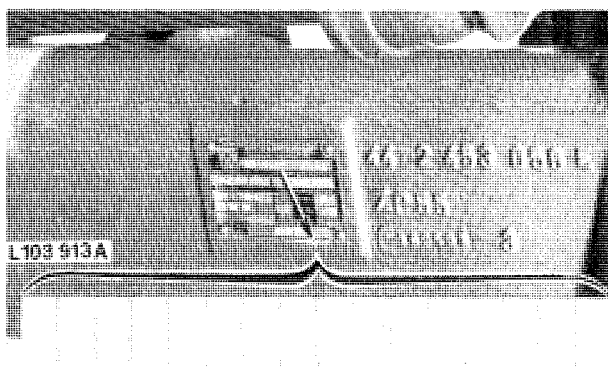

L103913A-LA71005AE-180385

### SOUND-GARD BODY SERIAL NUMBER

With operator's cab door open, cab serial number plate is visible in roof recess as you enter the cab.

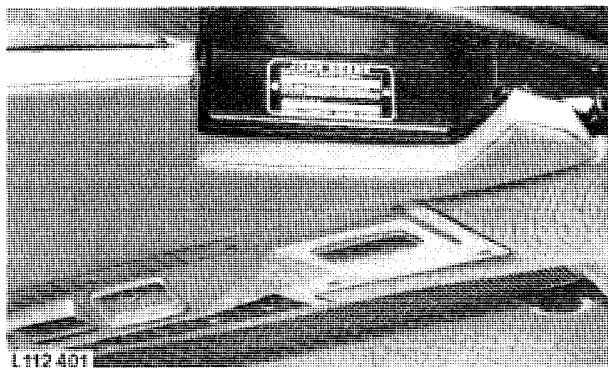

L112401-LA91005AE-051185

### ROLL-GARD SERIAL NUMBER

The ROLL-GARD serial number plate is located on the longitudinal support.

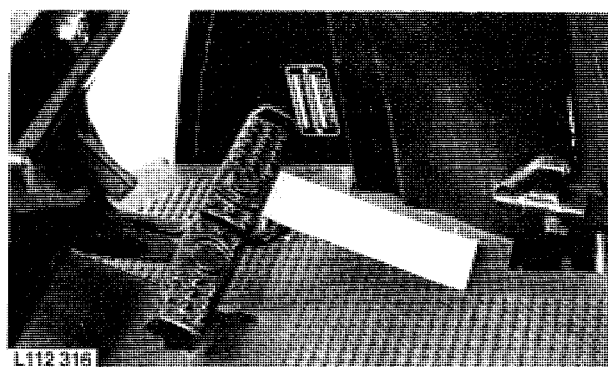

L112316-LA91005AE-051185

*Specifications*

**MODEL SERIAL NUMBERS**

Fuel injection pump, fuel injection nozzles, alternator, starting motor, hydrostatic steering valve, air conditioning system compressor (when equipped) and hydraulic pump have serial numbers to facilitate identification of different makes of a given unit.

TECHDA-LA71005BE-180385

*Specifications*

**ENGINE**

Number of cylinders .....	6
Cylinder liner bore .....	106.5 mm (4.19 in.)
Stroke .....	110 mm (4.33 in.)
Displacement .....	5883 cm <sup>3</sup> (359 cu.in.)
Compression ratio .....	17.4 : 1
Max. torque at 1400 rpm .....	392 Nm (289 ft-lb)
Firing order .....	1-5-3-6-2-4
Valve clearance (engine hot or cold)	
– Intake valve .....	0.35 mm (0.014 in.)
– Exhaust valve .....	0.45 mm (0.018 in.)
Slow idle speed .....	880 to 920 rpm
Fast idle speed .....	2510 to 2610 rpm
Rated engine speed .....	2400 rpm
Working speed range .....	1400 to 2400 rpm
Engine speed for PTO operation .....	2400 rpm
Flywheel horsepower at engine rated speed of 2400 rpm	
– According to DIN 70 020 .....	82 kW (112 hp)
PTO* horsepower at engine rated speed of 2400 rpm	
– According to SAE J 816 b .....	71 kW (95 hp)
Lubrication system .....	Full internal force feed system with full flow filter

\* With the engine run in (above 100 hours of operation) and at operating temperature (engine and transmission), measured by means of a dynamometer  
Permissible variation  $\pm 5\%$

TECHDA-LA91005AE-051185

*Specifications*

**ENGINE CLUTCH**

- Type ..... Single dry disk clutch with torsion damper, foot-operated

**COOLING SYSTEM**

- Type ..... Pressurized system with centrifugal pump
- Temperature regulation ..... Two thermostats

**FUEL SYSTEM**

- Type ..... Direct injection
- Fuel injection pump timing to engine ..... TDC
- Fuel injection pump type ..... Distributor type with two pistons  
Stanadyne no. DB2 4378
- Air cleaner ..... Dry-type air cleaner with secondary (safety) element

**ELECTRICAL SYSTEM**

- Batteries ..... 2 x 12 volt, 88 Ah
- Alternator with internal regulator ..... 14 volt, 55 amps.
- Starting motor ..... 12 volt, 3 kW (4 hp)
- Battery terminal grounded ..... negative

**SYNCHRONIZED TRANSMISSION**

- Type ..... Synchronized transmission
- Gear selections ..... 8 forward and 4 reverse
- Gear shifting ..... Two forward groups and one reverse group;  
Synchronized forward and reverse shifting within groups

**HI-LO SHIFT UNIT**

- Type ..... Hydraulic gear reduction unit which can be shifted under load with "wet" multiple disk clutch and brake packs.
- Travel speed decreases in each gear by ..... approx. 20 %
- Shifting to reduced (Lo) speed ..... hydraulic
- Shifting to normal (Hi) speed ..... preloaded cup springs

TECHDA-LA71005DE-180385

*Specifications*

**DIFFERENTIAL AND FINAL DRIVES**

- Type of differential ..... spiral bevel gears
- Type of final drive ..... planetary reduction drive

**DIFFERENTIAL LOCK**

- Operation ..... hand or foot operated
- Disengaged ..... automatically as soon as traction has equalized

**PTO**

- Type ..... independent of transmission, can be engaged and disengaged under load
- PTO speeds at engine speed of 2400 rpm ..... 540/1000 rpm, interchangeable
- PTO clutch ..... hydraulically operated "wet" disk clutch
- PTO brake ..... hydraulically operated "wet" disk brake

**FRONT PTO**

- Type ..... independent of transmission, can be engaged and disengaged under load
- Control ..... electrical/hydraulic solenoid switch
- PTO speed at an engine speed of 2175 rpm ..... 1000 rpm
- PTO clutch ..... hydraulically operated "wet" disk clutch
- PTO brake ..... hydraulically operated "wet" disk brake

**PTO SPEEDS**

at engine speed	540 rpm shaft	1000 rpm shaft
- 900 rpm .....	202 rpm	375 rpm
- 2100 rpm .....	472 rpm	875 rpm
- 2400 rpm .....	540 rpm	1000 rpm
- 2500 rpm .....	562 rpm	1041 rpm
- 2610 rpm .....	587 rpm	1087 rpm

TECHDA-LA91005BE-051185

Specifications

**FRONT WHEEL DRIVE**

- Type ..... hydraulically controlled, shift under load with "wet" disk clutch
- Control ..... electrical/hydraulic solenoid switch
- Drive engagement ..... preloaded cup springs
- Drive disengagement ..... hydraulic

**HYDROSTATIC STEERING**

- Type ..... without mechanical linkage between steering valve and front wheels

**FOOT BRAKES**

- Rear brake ..... self-adjusting, hydraulically operated "wet" disk brakes

**HANDBRAKE**

- Type ..... mechanically operated band-type locking brake acting on the differential

**HYDRAULIC SYSTEM**

- Type ..... closed, constant pressure system
- System pressure when pump pistons idle ..... 16000 kPa (160 bar; 2320 psi)
- Operating pressure ..... 14000 kPa (140 bar; 2050 psi)
- Hydraulic pump ..... 8-piston pump with variable displacement

**ROCKSHAFT**

- Regulation ..... load control, load-and-depth control, float position
- Control ..... via draft links

FRONT HITCH ..... controlled by selective control valve

GROUND TRAVEL SPEEDS ..... see Operator's Manual

TECHDA-LA91005CE-051185

*Specifications*

**FRONT AND REAR WHEELS**

– Tires, tread widths, tire pressures  
and ballast weights ..... see Operator's Manual

DIMENSIONS AND WEIGHTS ..... see Operator's Manual

**CAPACITIES**

Fuel tank ..... 134.0 liters (35.4 U.S. gal.)  
 – Auxiliary tank ..... 52.0 liters (13.7 U.S. gal.)  
 Cooling system  
 – with ROLL-GARD ..... 17.0 liters (4.5 U.S. gal.)  
 – with SOUND-GARD Body ..... 19 liters (5 U.S. gal.)  
 Crankcase with filter ..... 11.5 liters (3.0 U.S. gal.)  
 Transmission/hydraulic system (including  
 oil reservoir and oil cooler)  
 – Initial filling ..... 55.0 liters (14.5 U.S. gal.)  
 – Oil change ..... 47.0 liters (12.4 U.S. gal.)  
 Front wheel drive  
 – Front axle housing ..... 7.0 liters (1.85 U.S. gal.)  
 – Wheel hub housing, each ..... 0.75 liters (0.2 U.S. gal.)

TECHDA-LA91005DE-051185

**STANDARD TORQUES FOR HARDWARE**

**Recommended torques in Nm and ft-lb  
for hose and pipeline connections**

(A)	(B)		(C)	
	Nm	ft-lb	Nm	ft-lb
3/8-24 UNF	7,5	5,5	8	6
7/16-20 UNF	10	7	12	9
1/2-20 UNF	12	9	15	11
9/16-18 UNF	15	11	25	18
3/4-16 UNF	25	20	45	35
7/8-14 UNF	40	30	60	45
1-1/16-12 UNC	60	45	100	75
1-3/16-12 UNC	70	50	120	90
1-5/16-12 UNC	80	60	140	105
1-5/8-12 UNC	110	80	190	140
1-7/8-12 UNC	150	110	220	160

A-Thread size

B-With O-rings

C-With cone

L 110 192

L110192-LA71005AE-260385

Specifications

**Recommended torques in Nm and ft-lb for  
UNC and UNF cap screws**

A	10.9 C		12.9 D	
	Nm	ft-lb	Nm	ft-lb
1/4	15	10	20	15
5/16	30	20	40	30
3/8	50	35	70	50
7/16	80	55	110	80
1/2	120	85	170	120
9/16	180	130	240	175
5/8	230	170	320	240
3/4	400	300	580	425
7/8	600	445	930	685
1	910	670	1400	1030
1-1/8	1240	910	1980	1460
1-1/4	1700	1250	2800	2060

L 110 193

A-Head marking  
(identifying strength)  
B-Thread O.D. (in.)

C-Tempered steel high strength  
bolts and cap screws  
D-Tempered steel extra high  
strength bolts and cap screws

*NOTE: A variation of  $\pm 10\%$  is permissible for all  
torques indicated in this chart.*

Torque figures indicated above and in the specification sections of this manual are valid for non-greased or non-oiled threads and heads unless otherwise specified. Therefore, do not grease or oil bolts or cap screws unless otherwise specified in this manual.

L110193-LA71005AE-260385

Specifications

**Recommended torques in Nm and ft-lb for metric cap screws**

A	8.8 C		10.9 D		12.9 E	
	Nm	ft-lb	Nm	ft-lb	Nm	ft-lb
M5	7	5	9	6,5	10	8,5
M 6	10	8,5	15	10	20	15
M 8	30	20	40	30	40	30
M 10	50	35	80	60	90	70
M 12	100	75	140	100	160	120
M 14	160	120	210	155	260	190
M 16	240	175	350	260	400	300
M 20	480	355	650	480	780	575
M 24	820	605	1150	850	1350	995
M 30	1640	1210	2250	1660	2700	1990
M 36	2850	2110	4000	2950	4700	3465

**L 110 194**

(identifying strength)  
B-Thread O.D. (mm)

bolts and cap screws  
D-Tempered steel extra high  
strength bolts and cap screws

*NOTE: A variation of  $\pm 10\%$  is permissible for all torques indicated in this chart.*

Torque figures indicated above and in the specification sections of this manual are valid for non-greased or non-oiled threads and heads unless otherwise specified. Therefore, do not grease or oil bolts or cap screws unless otherwise specified in this manual.

L110194-LA71005AE-190385

# PREDELIVERY, DELIVERY AND AFTER-SALE INSPECTIONS

## SPECIAL TOOLS

JT 05509

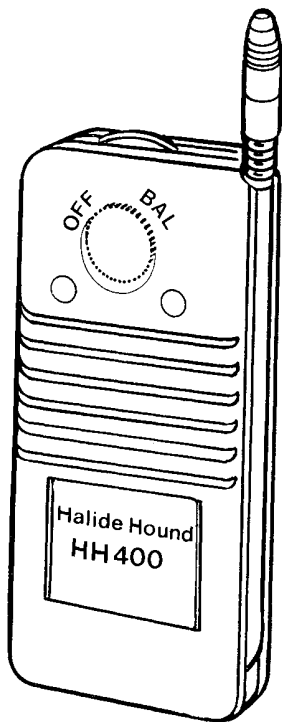

(A)

- A-Checking refrigerant lines for leaks (with air conditioning system)
- B-Turning engine for checking valve clearance
- C-Checking specified torques of SOUND-GARD Body or ROLL-GARD mountings

JDE - 83

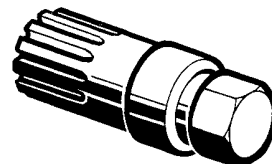

(B)

KJD 10 138

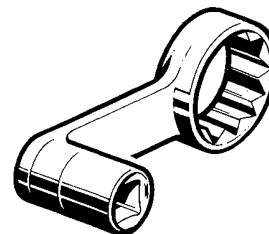

(C)

L113715

L108 562

L113715,L108562-LA91010AE-030386

## SPECIFICATIONS

### ENGINE SPEEDS

- Slow idle speed .....	880 to 920 rpm
- Fast idle speed .....	2510 to 2610 rpm
- Rated engine speed .....	2400 rpm

### FAN BELT

Fan belt should have 19 mm (3/4 in.) flex with 90 N (20 lb) pull midway between crankshaft and alternator or water pump (use a spring scale).

### COMPRESSOR BELT

Compressor belt should have 19 mm (3/4 in.) flex with 60 N (13 lb) pull midway between both pulleys.

### BATTERIES

Specific gravity at an acid temperature of 20° C (68° F)

- Normal and arctic conditions .....	1.28
- Tropical conditions .....	1.23

### TOE-IN

- Front wheel toe-in .....	2 to 5 mm. (5/64 to 13/64 in.)
----------------------------	--------------------------------

### BRAKES

- To check brake setting, load each brake pedal for 1 minute with .....	270 N (60 lb)
- Lowering of a brake pedal within 1 minute at a load of 270 N (60 lb) max .....	approx. 25 mm (1 in.)
- Handbrake lever setting (third or fourth notch) .....	110 N (25 lb)

### CAPACITIES

Engine crankcase	
- with filter change .....	11.5 liters (3.0 U.S. gal.)
Front wheel drive	
- Front axle housing .....	7.0 liters (1.85 U.S. gal.)
- Wheel hub housings, each .....	0.75 liters (0.2 U.S. gal.)

INSPEK-L71010BE-091184

### TORQUES FOR HARDWARE

Steel disk to front wheel hub .....	300 Nm (220 ft-lb)
Steel disk to front wheel rim .....	250 Nm (185 ft-lb)
On tractors with flanged rear axle	
- Rear wheels to rear axle .....	400 Nm (300 ft-lb)
- Steel disk to rear wheel rim .....	250 Nm (180 ft-lb)
On tractors with rack-and-pinion axle	
- Wheel disk to rear wheel rim .....	230 Nm (170 ft-lb)
- Pinion shaft - wheel sleeve to wheel hub .....	215 Nm (160 ft-lb)
- Sleeve attaching screws to wheel hub .....	400 Nm (300 ft-lb)

RADER-LA98005AE-121185

### SOUND-GARD Body or ROLL-GARD cab rubber mounting blocks

- Cap screws and hex. nuts .....	200 Nm (145 ft-lb)
----------------------------------	--------------------

INSPEK-LA91010BE-051185

## **PREDELIVERY INSPECTION**

The John Deere delivery receipt, when properly filled out and signed by the dealer and customer, verifies that the predelivery and delivery services were satisfactorily performed. When delivering this tractor, give the customer his copy of the delivery receipt and the operator's manual. Explain their purpose to him.

To promote complete customer satisfaction, a predelivery inspection including repair of possible shipping damage and giving the finishing touches to the tractor is of prime importance to the dealer.

After the first 100 operating hours an inspection should be performed by the dealer to make sure that the tractor is in proper operating condition.

The predelivery and after-sales inspection check lists in the operator's manual will be completed by the dealer when the inspections are being performed. He will then forward them to the sales branch service department.

INSPEK-LA71010DE-091184

## **CHECKING FUEL LINES FOR LEAKS**

Refer to Engine Component Technical Manual (CTM-4) in the event of malfunctions.

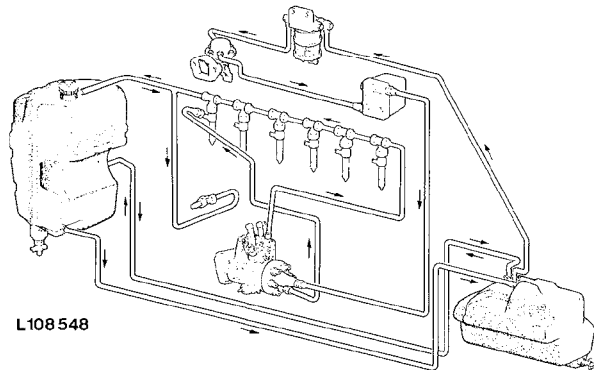

L108548-LA91010AE-040386

## **EXAMINING ENGINE FOR LEAKS**

Refer to Engine Component Technical Manual (CTM-4) in the event of malfunctions.

INSPEK-LA91010EE-040386

### CHECKING OIL LEVEL IN ENGINE CRANKCASE

If necessary, add oil to bring oil level to top mark on dipstick. Use JOHN DEERE Torq-Gard Supreme<sup>®</sup> engine oil SAE 10W-20 or an equivalent oil (see Group 15).

A—Oil dipstick  
B—Filler cap

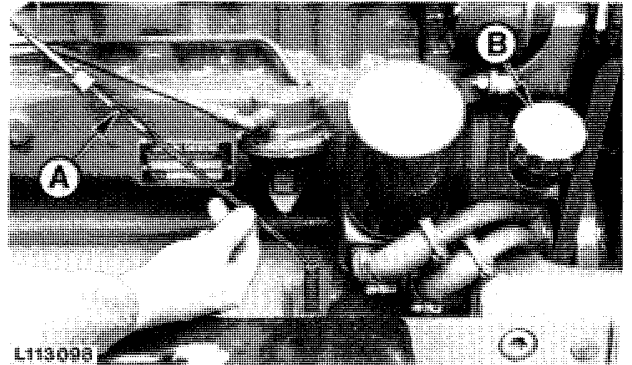

### CHECKING COOLANT LEVEL

Coolant must reach up to marking plate in radiator.

JOHN DEERE engine cooling fluid is filled into the cooling system at the factory. It protects the engine against corrosion and against frost down to  $-36^{\circ}\text{C}$  ( $-35^{\circ}\text{F}$ ).

**IMPORTANT: Use only JOHN DEERE engine cooling fluid in the cooling system, independent of the season.**

If no JOHN DEERE engine cooling fluid is available, use a mixture of 50% ethylene-glycol antifreeze/ anti-corrosion inhibitor and 50% clear, soft water. This guarantees engine protection against corrosion and frost down to  $-36^{\circ}\text{C}$  ( $-35^{\circ}\text{F}$ ).

Never use any cooling system sealing additives.

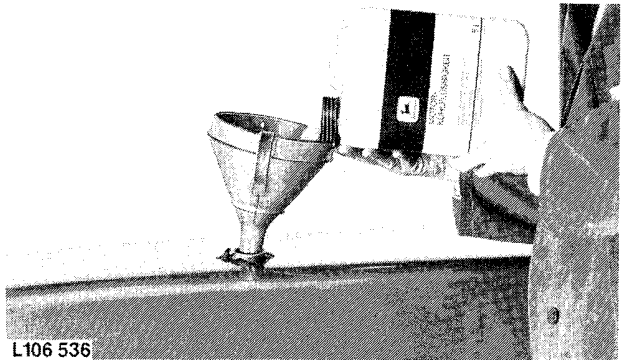
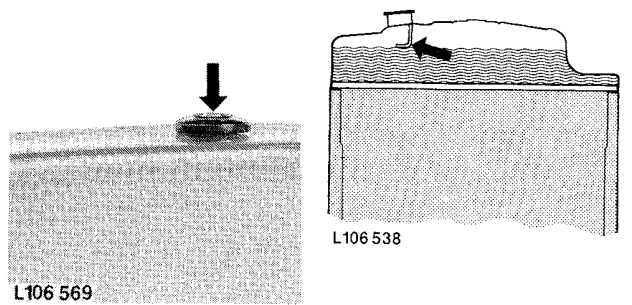

### CHECKING ENGINE IDLE SPEEDS

Warm up engine to operating temperature and check speeds.

Slow idle speed: 880 to 920 rpm  
Fast idle speed: 2510 to 2610 rpm

See Engine Component Technical Manual (CTM-4) or Section 30, Group 15, for adjustment.

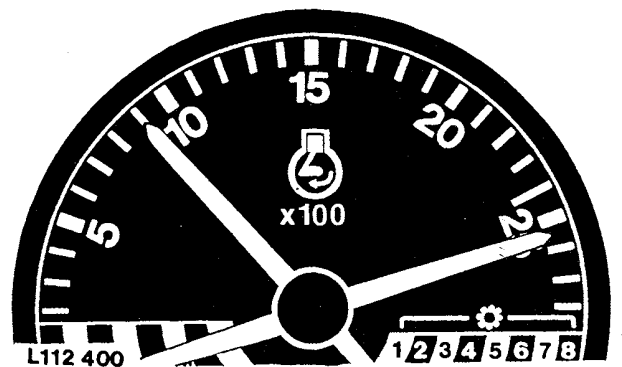

### CHECKING V-BELT TENSION

Fan belt should have 19 mm (3/4 in.) flex with 90 N (20 lb) pull midway between crankshaft and alternator or water pump (use a spring scale).

- A-Fan belt
- B-Securing nuts

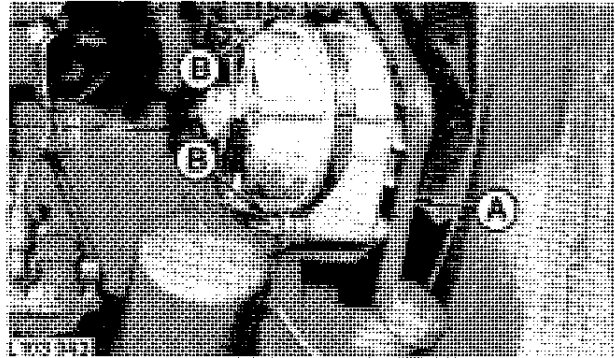

L103943-LA91010CAE-030386

### CHECKING COMPRESSOR BELT TENSION (Tractors with Air Conditioning System)

Compressor belt should have 19 mm (3/4 in.) flex with 60 N (13 lb) pull midway between both pulleys.

- A-V-belt
- B-Securing nut
- C-Adjusting screw

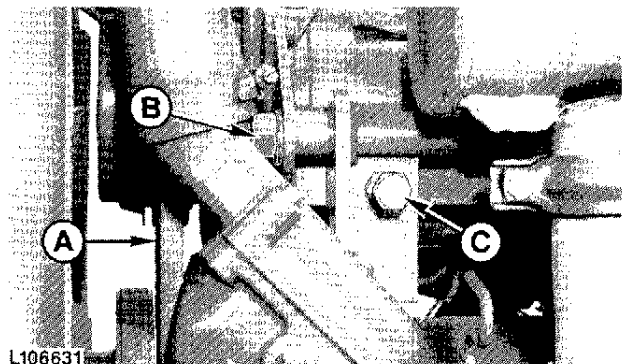

L106631

L106631-LA71010AE-091184

### CHECKING FUNCTION OF ENGINE SHUT-OFF CABLE

Move hand throttle lever completely forward and idle engine for 1 to 2 minutes.

Completely pull out shut-off knob (A), making sure engine stops immediately. Switch off main switch (B).

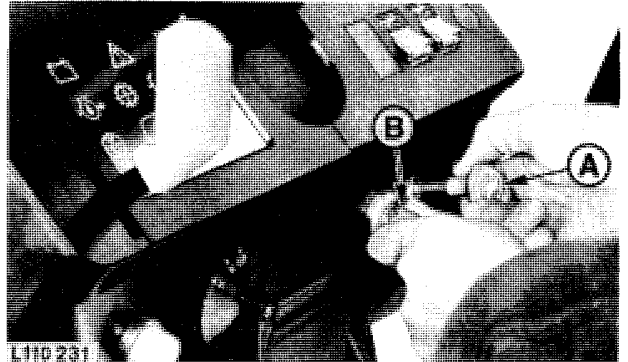

L110 231

L110231-LA91010AE-051185

### CHECKING AIR CLEANER AND SAFETY ELEMENTS FOR CORRECT INSTALLATION

Make sure that dust unloading valve (C) (rubber cap) is installed on air cleaner.

- A-Air cleaner element
- B-Safety element
- C-Dust unloading valve

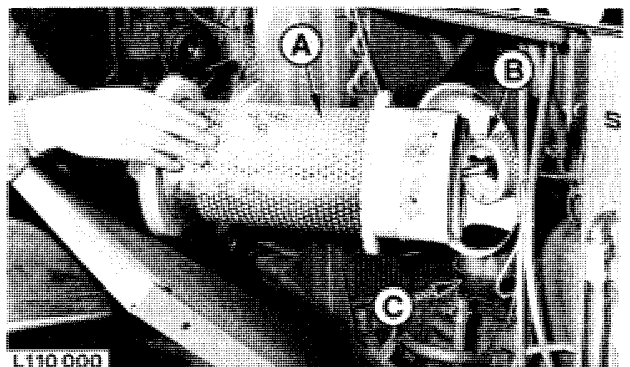

L110 000

L110000-LA71010AE-091184

### CHECKING HOSE CLAMPS OF AIR INTAKE FOR TIGHTNESS

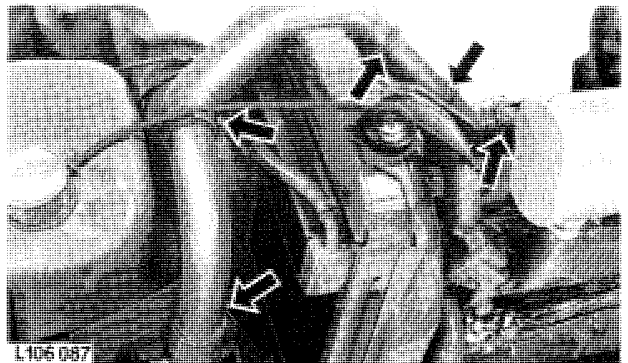

L106 087

L106087-LA91010AE-051185

### INSTALLING EXHAUST STACK

Install weather flap with flap hinge at the rear (as seen in direction of forward travel).

Distance (A) between cap and stack end must be 2 mm (0.01 in.).

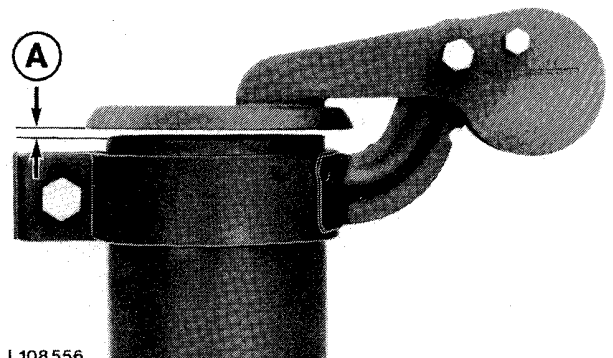

L108 556

L108556-LA71010AE-091184

### IMPORTANT NOTES

If the engine is to be run for a short time without battery (using a slave battery for starting), do not, under any circumstances, interrupt this circuit by switching off the main switch before stopping the engine by means of the fuel pump shut-off cable. An additional load (lights) must also be switched on. Do not run engine above 1000 rpm. Insulate battery end of disconnected started cable properly to avoid damage to alternator and regulator.

Do not connect ground strap of slave battery to SOUND-GARD Body or ROLL-GARD.

Observe proper polarity when connecting batteries and chargers. Improperly connected batteries (" + " and " - ") results in immediate destruction of rectifier diodes.

**A-Positive terminals**  
**B-Negative terminals**

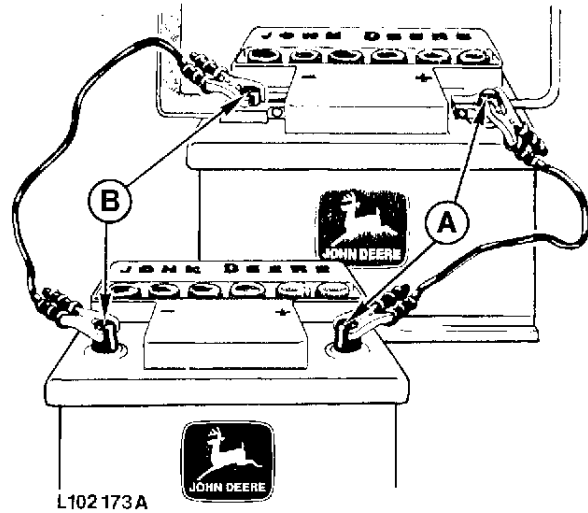

L102173A-LA91010AE-051185

### CHECKING BATTERIES

Check battery terminals and cable ends and, if necessary, clean and coat them with petroleum jelly.

Check electrolyte level in each battery cell. If necessary, add distilled water to bring level above cell plates.

**A-Filler caps**

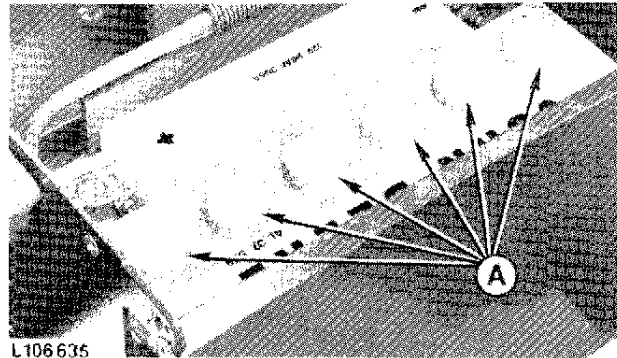

L106635

L106635-LA71010AE-091184

### CHECKING NEUTRAL START SYSTEM

Depress clutch pedal (A).  
Move gear shift lever (B) in neutral position.  
Move range shift lever (C) in any range position.  
Pull engine shut-off knob (D) out.  
Turn starter switch (E) to start position. Starter should NOT crank. If it does, see Section 240, Group 10.

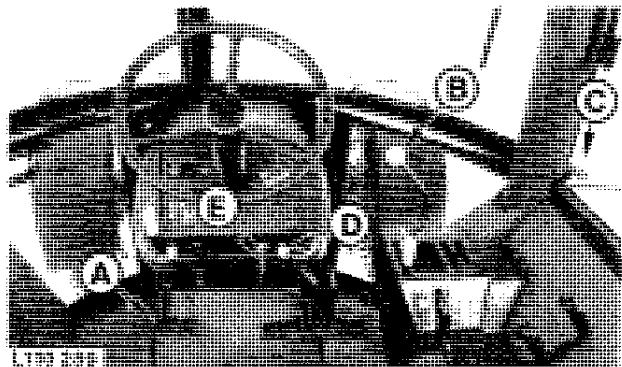

L110288

L110288-LA91010AE-051185

### CHECKING LIGHTING SYSTEM

See Operator's Manual.

Check adjustment of headlights and adjust, when necessary.

See Section 240, Group 15, in the event of malfunctions.

A—Light switch  
B—Dimmer switch

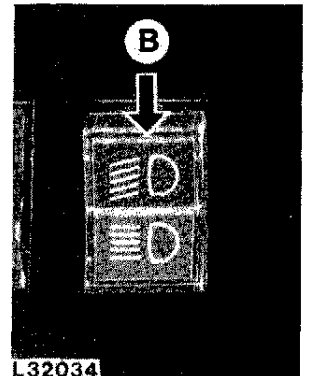
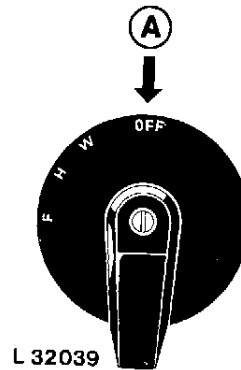

L32039,L32034-LA91010AE-051185

### CHECKING FAN SWITCH (With SOUND-GARD Body)

Open air louvers (B).

Check function of three-stage cab ventilation and heater switch (A).

See Section 240, Group 10 in the event of malfunctions.

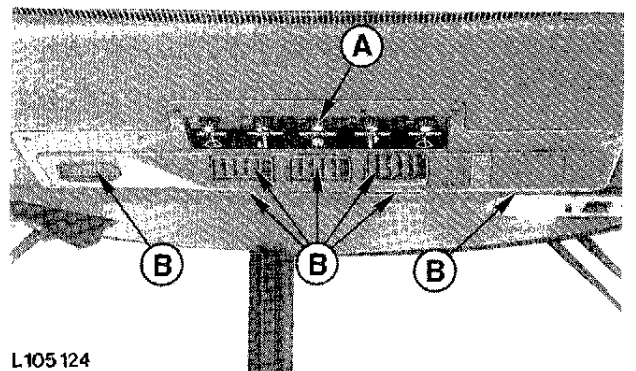

L105124-LA91010AE-051185

### CHECKING HEATER CONTROL SWITCH (With SOUND-GARD Body)

With engine running at operating temperature, turn control switch to the right and wait until warm air enters cab through the air louvers.

See Section 290, Group 10 in the event of malfunctions.

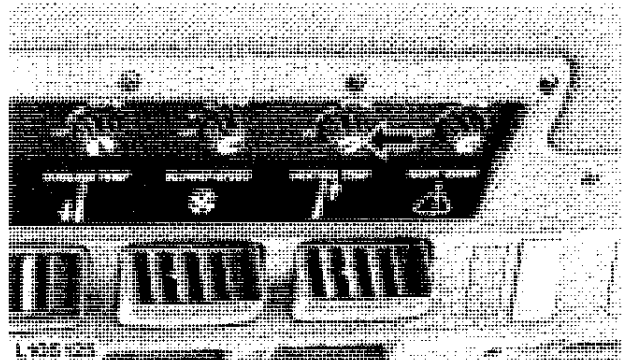

L105125-LA91010AE-051185

### CHECKING THERMOSTAT SWITCH (With Air Conditioning System)

With fan switched on, turn infinitely adjustable switch to the right and wait until cool air enters cab through the air louvers.

See Section 290, Group 05 in the event of malfunctions.

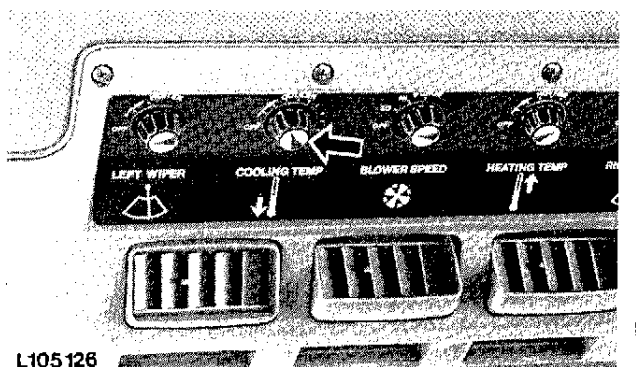

L105126-LA91010AE-051185



**Suggest:**

**If the above button click is invalid.**

**Please download this document**

**first, and then click the above link**

**to download the complete manual.**

**Thank you so much for reading**

### **CHECKING FUNCTION OF WINDSHIELD WIPERS**

Check both windshield wiper speeds by turning both two-speed switches.

See Section 40, Group 10, in the event of malfunctions.

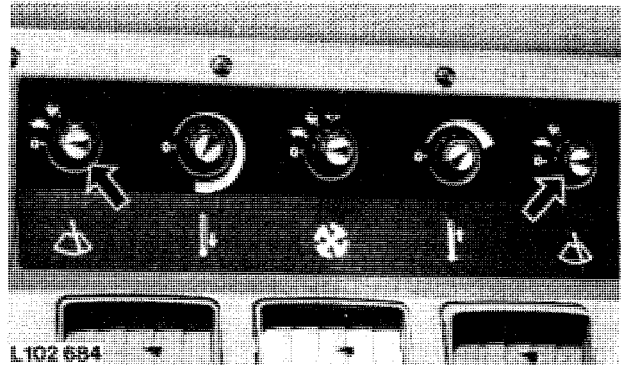

L102684-LA71010AE-091184

### **CHECKING CONTROLS AND INSTRUMENTS**

See Operator's Manual.

See Section 40, Group 10, in the event of malfunctions.

INSPEK-LA71010FE-091184

### **CHECKING CAB INTERIOR LIGHTS**

Turn switch (B) to position 1, lamp (A) glows continuously and, in position 2, it glows as long as cab door is open.

Lamp (C) illuminates transmission shift lever as soon as headlights are switched on.

See Section 240, Group 10, in the event of malfunctions.

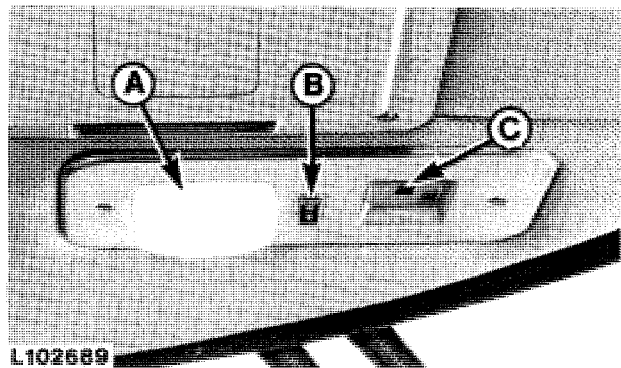

L102689-LA71010AE-091184

**<https://www.ebooklibonline.com>**

Hello dear friend!

Thank you very much for reading.

Enter the link into your browser.

The full manual is available for immediate download.

**<https://www.ebooklibonline.com>**