



2950 Tractor



JOHN DEERE

TECHNICAL MANUAL 2950 Tractor

TM4407 (01AUG86) English

John Deere Werke Mannheim
TM4407 (01AUG86)

LITHO IN U.S.A.
ENGLISH

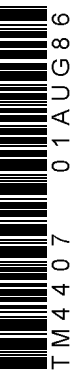

2950 TRACTOR TECHNICAL MANUAL TM-4407 (Apr-86)

CONTENTS

The engine information has been removed from this manual. For engine information, refer to engine component technical manual, CTM-4, 3179, 4239, and 6359 Engines.

SECTION 10 - GENERAL

- Group 00 - Specifications and Special Tools
- Group 05 - Predelivery, Delivery, and After-Sales Inspections
- Group 10 - Lubrication and Service
- Group 15 - Tune-Up
- Group 20 - Tractor Separation

SECTION 20 - ENGINE

- Group 00 - Specifications
- Group 05 - Radiator

SECTION 30 - FUEL AND AIR INTAKE SYSTEM

- Group 00 - Specifications and Special Tools
- Group 05 - General Information, and Diagnosing Malfunctions
- Group 10 - Fuel Tank and Water Trap
- Group 15 - Cold Weather Starting Aids
- Group 20 - Speed Control Linkage
- Group 25 - Air Cleaner

SECTION 40 - ELECTRICAL SYSTEM

- Group 00 - Specifications and Special Tools
- Group 05 - Description, Diagnosing Malfunctions and Tests
- Group 06 - Connector Repair
- Group 10 - Wiring Harnesses
- Group 15 - Controls and Instruments
- Group 20 - Lighting System
- Group 25 - Wiring Diagrams
- Group 30 - Starting Motor
- Group 35 - Alternator

SECTION 50 - POWER TRAIN

- Group 00 - Specifications and Special Tools
- Group 05 - Description, Operation and Lubrication System
- Group 10 - Clutch Operating Linkages
- Group 15 - Engine Clutch
- Group 20 - Hi-Lo Shift Unit
- Group 25 - Creeper Transmission
- Group 30 - Transmission Shift Linkages
- Group 35 - Synchronized Transmission and Transmission Oil Pump
- Group 40 - Differential
- Group 45 - Final Drives
- Group 50 - Independent PTO
- Group 55 - Mechanical Front Wheel Drive

SECTION 60 - STEERING SYSTEM AND BRAKES

- Group 00 - Specifications and Special Tools
- Group 05 - Steering System
- Group 10 - Brakes

All information, illustrations and specifications contained in this technical manual are based on the latest information available at the time of publication. The right is reserved to make changes at any time without notice.

COPYRIGHT® 1986
DEERE & COMPANY
Moline, Illinois
All rights reserved
Previous Edition
Copyright® 1982, 1984
Deere & Company

CONTENTS—Continued**SECTION 70 - HYDRAULIC SYSTEM**

- Group 00 - Specifications and Special Tools
- Group 05 - Description, Diagnosing Malfunctions and Tests
- Group 10 - Oil Reservoir, Filter, Valves and Oil Cooler
- Group 15 - Hydraulic Pump
- Group 20 - Rockshaft
- Group 25 - Selective Control Valve (Poppet Valve Type) and Breakaway Coupler
- Group 26 - Selective Control Valve (Spool Type) and Quick Coupler
- Group 30 - Remote Cylinder

SECTION 90 - OPERATOR'S STATION

- Group 00 - Specifications and Special Tools
- Group 05 - Air Conditioning System
- Group 10 - Cab Ventilation and Heating
- Group 15 - Seats
- Group 20 - SOUND-GARD Body
- Group 25 - ROLL-GARD Protective Structure

SECTION 80 - ENGINE

- Group 00 - Specifications
- Group 05 - Front Axle
- Group 10 - Front and Rear Wheels

<https://www.ebooklibonline.com>

Hello dear friend!

Thank you very much for reading.

Enter the link into your browser.

The full manual is available for immediate download.

<https://www.ebooklibonline.com>

Section 10 GENERAL

CONTENTS OF THIS SECTION

	Page		Page
GROUP 00 - SPECIFICATIONS AND SPECIAL TOOLS		GROUP 05 - PREDELIVERY, DELIVERY AND AFTER-SALES INSPECTIONS	
Specifications	10-00-3	Tractor Storage	10-05-1
Serial Numbers	10-00-3	Predelivery Inspection	10-05-2
Model Numbers	10-00-3	Delivery Inspection	10-05-9
Engine	10-00-3	After-Sales Inspection	10-05-10
Engine Clutch	10-00-4		
Cooling System	10-00-4	GROUP 10 - LUBRICATION AND SERVICE	
Fuel System	10-00-4	Lubrication and Service	10-10-1
Electrical System	10-00-4		
Synchronized Transmission	10-00-4	GROUP 15 - TUNE-UP	
Hi-Lo Shift Unit	10-00-4	Preliminary Engine Testing	10-15-1
Creeper Transmission	10-00-5	Dynamometer Test	10-15-1
Differential and Final Drives	10-00-5	Testing Compression Pressure	10-15-2
Differential Lock	10-00-5	Engine Tune-Up	10-15-2
PTO	10-00-5	Checking Tractor Operation	10-15-7
Mechanical Front Wheel Drive	10-00-5	Standard Torques	10-15-8
Hydrostatic Steering	10-00-6		
Foot Brakes	10-00-6	GROUP 20 - TRACTOR SEPARATION	
Handbrake	10-00-6	Separating between Engine and	
Hydraulic System	10-00-6	Tractor Front End	10-20-1
Capacities	10-00-6	Removal and Installation of Engine	10-20-5
Travel Speeds	10-00-6	Removal and Installation of	
Front and Rear Wheels	10-00-6	Clutch Housing	10-20-8
Dimensions and Weights	10-00-6	Removal and Installation of	
Predelivery, Delivery and		Final Drives	10-20-10
After-Sales Inspections	10-00-7	Removal and Installation of	
Lubrications and Service	10-00-8	Rockshaft	10-20-15
Tune-up	10-00-9	Removal and Installation of	
Tractor Separation	10-00-10	SOUND-GARD® Body	10-20-17
Standard Torques	10-00-11		
Special Tools	10-00-13		

Group 00

SPECIFICATIONS AND SPECIAL TOOLS

SPECIFICATIONS

Serial Numbers

The engine serial number is stamped into the plate located on the lower front right-hand side of the cylinder block.

NOTE: When ordering engine parts, quote all digits of serial number stamped on the plate

The plate showing the tractor serial number is located on the right-hand side of the front axle carrier.

NOTE: When ordering tractor service parts (excluding engine parts), quote all digits and letters of serial number stamped on the plate.

A plate showing the tractor type, transmission serial number, cone point measurement etched into pinion face of differential drive shaft (as well as reduction of differential) is located on the right-hand side of the transmission case.

Model Numbers

The fuel injection pump, fuel injection nozzles, alternator, starting motor, hydrostatic steering valve and hydraulic pump have model numbers to facilitate identification of different makes of a given unit.

Engine

Number of cylinders	6
Cylinder liner bore	106.5 mm (4.19 in.)
Stroke	110 mm (4.33 in.)
Displacement	5883 cm ³ (359 cu. in.)
Compression ratio	
up to engine serial no. 547636CD	16.8:1
from engine serial no. 547637CD	17.4:1
Maximum torque at 1400 rpm	330 N·m (243 lb-ft)
Firing order	1-5-3-6-2-4
Valve clearance (engine hot or cold)	
Intake valve	0.35 mm (0.014 in.)
Exhaust Valve	0.45 mm (0.018 in.)
Fast idle speed	2610 to 2660 rpm
Slow idle speed	700 to 800 rpm
Rated engine speed	2500 rpm
Working speed range	1400 to 2500 rpm

PTO* horsepower at engine rated speed—2500 rpm 63 kW (85 hp)

Lubrication system Full internal force feed system with full flow filter

Engine Clutch Single dry disk clutch with torsion damper, foot-operated

Cooling System

Type Pressurized system with centrifugal pump

Temperature regulation Two thermostats

Fuel System

Type Direct injection

Fuel injection pump timing to engine TDC

Fuel injection pump type (Roto Diesel R 3462 F 690) (ISO) Distributor type

Air cleaner Dry-type air cleaner with secondary (safety) element

Electrical System

Batteries 2 x 12 volts, 88 Ah

Alternator with internal regulator 14 volts, 33 or 55 amps.

Starting motor 12 volts (3 kW) (4 hp)

Battery terminal grounded Negative

Synchronized Transmission

Type Synchronized transmission

Gear selections 8 forward and 4 reverse

Gear shifting Two forward groups and one reverse group
Synchronized forward and reverse shifting
within groups

Hi-Lo Shift Unit

Type Hydraulic gear reduction unit which can be
shifted under load with "wet" multiple
disk clutch and brake packs

Travel speed decreases in each gear by Approx. 20 percent

Shifting to reduced (Low) speed Preloaded cup springs

Shifting to normal (High) speed Hydraulic

* With the engine run in (above 100 hours of operation) and having reached operating temperature (engine and transmission);
measured by means of a dynamometer. Permissible variation \pm 5 percent.

Creeper Transmission

Type Synchronized reduction unit
 Travel speed decreases in low (l) and reverse ranges by Approx. 79%
 Shifting both ranges Mechanical and not under load

Differential and Final Drives

Type of differential Spiral bevel gears
 Type of final drive Planetary reduction drive

Differential Lock

Operation Hand or foot operated
 Disengage Will disengage automatically as soon as traction has equalized

PTO

Type Independent of transmission, can be engaged and disengaged under load
 PTO speeds (with engine speed of 2400 rpm) 540/1000 rpm
 PTO clutch Hydraulically operated “wet” disk clutch
 PTO brake Hydraulically operated “wet” disk brake

ENGINE/PTO SPEED RELATIONSHIPS

Engine speed	540 rpm shaft	1000 rpm shaft
800	180	335
2400	540	1000
2500	565	1040
2660	600	1110

Mechanical Front Wheel Drive

Type Engaged hydraulically, under full load with “wet” disk clutch
 Control Electrical/hydraulic solenoid switch
 Engagement Preloaded cup springs
 Disengagement Hydraulic

Hydrostatic Steering Without mechanical linkage between steering valve and the front wheels

Foot Brakes Self-adjusting, hydraulically operated "wet" disk brakes

Handbrake Mechanically operated band-type locking brake acting on the differential

Hydraulic System

Type Closed center, constant pressure system

Standby pressure 15800 to 16200 kPa (158 to 162 bar) (2300 to 2350 psi)

Operating pressure 14000 kPa (140 bar) (2050 psi)

Hydraulic pump 8-piston pump with variable displacement

Capacities

Fuel tank 122 liters (32.0 U.S. gals.)

Cooling system

Without SOUND-GARD Body 17.0 L (4.5 U.S. gals.)

With SOUND-GARD Body 19.0 L (5.0 U.S. gals.)

Engine crankcase

Without filter change 11.0 L (2.9 U.S. gals.)

With filter change 11.5 L (3.0 U.S. gals.)

Hydraulic clutch reservoir 500 cm³ 17.5 fl. oz.

Transmission - Hydraulic system

Initial filling 68.0 L (18.0 U.S. gals.)

Oil change 60.0 L (15.9 U.S. gals.)

Mechanical front wheel drive

Front axle housing 7.0 L (7.85 U.S. gals.)

Wheel hub housing, each 0.75 L (0.2 U.S. gals.)

Travel Speeds See Operator's Manual

Front and Rear Wheels

Tires, tread widths, tire pressure and ballast weights See Operator's Manual

Dimensions and Weights See Operator's Manual

PREDELIVERY, DELIVERY AND AFTER-SALES INSPECTIONS

Engine Speeds

Slow idle	700 to 800 rpm
Fast idle	2610 to 2660 rpm
Rated speed	2500 rpm

Fan Belt

The fan belt should have 19 mm (3/4 in.) flex with 90 N (20 lb) pull midway between crankshaft and alternator or water pump (use a spring scale).

Batteries

Specific gravity at an electrolyte temperature of 20°C (68°F)

Normal and arctic conditions	1.28
Tropical conditions	1.23

Clutch Operating Linkage

Tractors Without SOUND-GARD Body

Clutch pedal free travel	approx. 25 mm (1 in.)
--------------------------------	-----------------------

Tractors With SOUND-GARD Body

Travel of slave cylinder operating rod	8.5 to 12.0 mm (5/16 to 15/32 in.)
--	------------------------------------

Front Wheel Toe-In

Tractors without MFWD	3 to 6 mm (0.12 to 0.25 in.)
Tractors with MFWD	0 to 3 mm (0 to 0.12 in.)

Torques for Hardware

Start safety switch in rockshaft housing, max.	50 N·m	(35 ft-lbs)
Front wheel rim to hub		
Tractors without MFWD	180 N·m	(130 ft-lbs)
Tractors with MFWD	300 N·m	(220 ft-lbs)
Axle knees to axle center, cap screws	400 N·m	(300 ft-lbs)
Tie rod clamps		
Cap screw (M10)	55 N·m	(40 ft-lbs)
Cap screw (M12)	90 N·m	(65 ft-lbs)
Tie rod tube, cap screw	55 N·m	(40 ft-lbs)
Rear wheels		
Rear wheels to axle	400 N·m	(300 ft-lbs)
Wheel disk to hub (rack-and-pinion axle)	400 N·m	(300 ft-lbs)
2-post ROLL-GARD protective structure		
Supports to crossbar, cap screws	200 N·m	(145 ft-lbs)
Supports to final drives, cap screws and nuts	400 N·m	(300 ft-lbs)

LUBRICATION AND SERVICE

Capacities

Engine crankcase

Without filter change	11.0 L	(2.9 U.S. gal.)
With filter change	11.5 L	(3.0 U.S. gal.)

Cooling system

Without SOUND-GARD Body	17.0 L	(4.5 U.S. gals.)
With SOUND-GARD Body	19.0 L	(5.0 U.S. gals.)

Transmission - Hydraulic system

Initial filling	68.0 L	(18.0 U.S. gal.)
Oil change	60.0 L	(15.9 U.S. gal.)

Mechanical front wheel drive

Front axle housing	7.0 L	(1.85 U.S. gal.)
Wheel hub housing, each	0.75 L	(0.2 U.S. gal.)

Service Intervals

Checking crankcase oil level	every 10 hours
Changing engine oil	every 100 hours
Changing engine oil filter	every 200 hours
Checking transmission/hydraulic system oil level	every 50 hours
Changing transmission/hydraulic system oil filter	every 500 hours
Changing transmission/hydraulic oil	every 1000 hours
Changing hydrostatic steering filter	every 1000 hours
Cleaning hydraulic pump strainer	every 1000 hours
Checking MFWD oil level	every 100 hours
MFWD oil change	every 1000 hours
Cleaning and packing front wheel bearings	every 1000 hours
Lubricating grease fittings	
Clutch throw-out bearing grease fitting (when equipped)	every 100 hours
Mechanical front wheel drive universal-jointed shaft	every 50 hours
In wet and muddy conditions	every 10 hours
Front axle and front axle bearings	every 50 hours
Rear axle bearings	every 500 hours
In wet and muddy conditions	every 10 hours
Three-point hitch	every 200 hours

TUNE-UP

PTO horsepower* at 2500 rpm rated engine speed	63 kW	85 hp
Slow idle	700 to 800 rpm	
Fast idle	2610 to 2660 rpm	
Rated engine speed	2500 rpm	
Air intake system vacuum	3.5 to 6.0 kPa	35 to 60 mbar (14 to 25 in. water head)
Air cleaner restriction warning switch closes at a vacuum of	5.5 to 6.5 kPa	55 to 65 mbar (22 to 26 in. water head)
Radiator cap high pressure valve opens at	40 to 50 kPa	0.4 to 0.5 bar (6 to 7 psi)
Radiator cap low pressure valve opens at	0 to 4 kPa	0 to 0.04 bar (0 to 0.6 psi)

Fan Belt

Fan belt should have 19 mm (3/4 in.) flex with 90 N (20 lb) pull midway between crankshaft and alternator or water pump (use a spring scale).

Compressor Belt

Compressor belt should have 19 mm (3/4 in.) flex with 60 N (13 lb) pull midway between pulleys.





* With the engine run in (more than 100 hours of operation) and having reached operating temperature (engine and transmission); measured by means of a dynamometer. Permissible variation $\pm 5\%$.

TRACTOR SEPARATION

Torques for Hardware

Front axle carrier to engine block, cap screws	230 N·m	(170 ft-lbs)
Front axle carrier to oil pan, cap screws	400 N·m	(300 ft-lbs)
Engine block to front axle carrier, cap screws	230 N·m	(170 ft-lbs)
Hydraulic pump drive shaft, cap screws	50 N·m	(35 ft-lbs)
Jointed shaft flange to front axle drive hub (tractors with MFWD), cap screws	75 N·m	(55 ft-lbs)
Clutch housing to engine block		
Cap screws	230 N·m	(170 ft-lbs)
Hex. nuts	230 N·m	(170 ft-lbs)
Oil pan to clutch housing, cap screws	230 N·m	(170 ft-lbs)
Clutch housing to transmission case, cap screws	160 N·m	(120 ft-lbs)
Oil drain plug of transmission case	135 N·m	(100 ft-lbs)
Hydraulic lines retainer to clutch housing, cap screw	45 N·m	(32 ft-lbs)
Final drive housings to transmission case, cap screws	230 N·m	(170 ft-lbs)
Rockshaft housing to transmission case, cap screws	120 N·m	(85 ft-lbs)
Rear wheels to rear axle	400 N·m	(300 ft-lbs)
Wheel disk to hub (rack and pinion axle)	400 N·m	(300 ft-lbs)
Rear fenders to final drive housings, hex. nuts	200 N·m	(145 ft-lbs)
2-post ROLL-GARD protective structure to final drive housings	400 N·m	(300 ft-lbs)
Both supports to crossbar	200 N·m	(145 ft-lbs)
Basic weight to front axle carrier, cap screws	400 N·m	(300 ft-lbs)
Drawbar to transmission case		
Front cap screws	230 N·m	(170 ft-lbs)
Rear cap screws	120 N·m	(85 ft-lbs)
SOUND - GARD Body to rubber bearing block, cap screws and hex. nuts	200 N·m	(145 ft-lbs)

STANDARD TORQUES

RECOMMENDED TORQUES IN N:m, AND FT-LBS FOR UNC AND UNF CAP SCREWS				
Head Marking (identifying strength)	  or 10.9*		  or 12.9**	
	Thread-O.D. (in.)	N:m	ft-lbs	N:m
1/4	15	10	20	15
5/16	30	20	40	30
3/8	50	35	70	50
7/16	80	55	110	80
1/2	120	85	170	120
9/16	180	130	240	175
5/8	230	170	320	240
3/4	400	300	580	425
7/8	600	445	930	685
1	910	670	1400	1030
1-1/8	1240	910	1980	1460
1-1/4	1700	1250	2800	2060

RW7097

NOTE: A variation of $\pm 10\%$ is permissible for all torques indicated in this chart.

Torque figures indicated above and in the Specification sections of this manual are valid for non-greased or non-oiled threads and heads unless otherwise specified. Therefore, do not grease or oil bolts or cap screws unless otherwise specified in this manual.

- * Tempered steel high-strength bolts and cap screws
- ** Tempered steel extra high-strength bolts and cap screws

RECOMMENDED TORQUES IN N:m, AND FT-LBS FOR METRIC CAP SCREWS						
Head Marking (identifying strength)	8.8*		10.9**		12.9***	
	N:m	ft-lbs	N:m	ft-lbs	N:m	ft-lbs
M5	7	5	9	6.5	10	8.5
M6	10	8.5	15	10	20	15
M8	30	20	40	30	40	30
M10	50	35	80	60	90	70
M12	100	75	140	100	160	120
M14	160	120	210	155	260	190
M16	240	175	350	260	400	300
M20	480	355	650	480	780	575
M24	820	605	1150	850	1350	995
M30	1640	1210	2250	1660	2700	1990
M36	2850	2110	4000	2950	4700	3465

RW7095

NOTE: A variation of $\pm 10\%$ is permissible for all torques indicated in this chart.

Torque figures indicated above and in the Specification sections of this manual are valid for non-greased or non-oiled threads and heads unless otherwise specified. Therefore, do not grease or oil bolts or cap screws unless otherwise specified in this manual.

* Regular bolts and cap screws

** Tempered steel high-strength bolts and cap screws

*** Tempered steel extra high-strength bolts and cap screws

RECOMMENDED TORQUES IN N:m, AND FT-LBS FOR PIPE AND HOSE CONNECTIONS				
Thread size	with O-rings		with Cone	
	N:m	ft-lbs	N:m	ft-lbs
3/8-24 UNF	7.5	5.5	8	6
7/16-20 UNF	10	7	12	9
1/2-20 UNF	12	9	15	11
9/16-18 UNF	15	11	25	18
3/4-16 UNF	25	20	45	35
7/8-14 UNF	40	30	60	45
1-1/16-12 UNC	60	45	100	75
1-3/16-12 UNC	70	50	120	90
1-5/16-12 UNC	80	60	140	105
1-5/8-12 UNC	110	80	190	140
1-7/8-12 UNC	150	110	220	160

RW7095

SPECIAL TOOLS

Tractor Separation

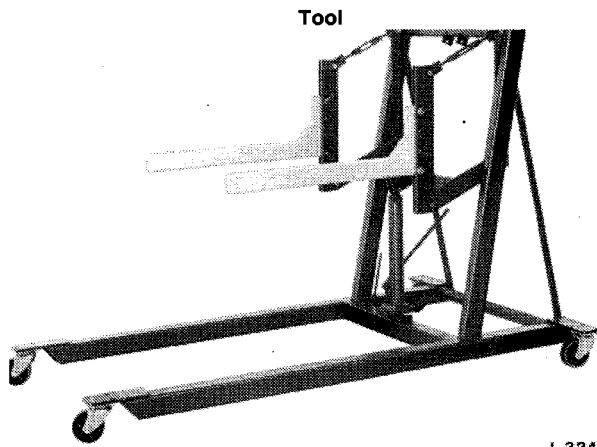

Tool

Number

Use

Brown Body Lift

To remove SOUND-GARD Body

L 32430

L32430

Fig. 1—Brown Body Lift

Tractor Separation — Continued

Number	Use
1. JD244-1 (Straight)	Tractor separations
2. JD244-2 (Bent)	

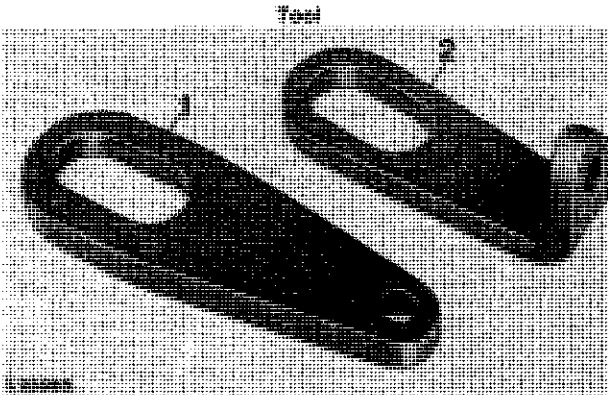

L23985

Fig. 2—Lifting Eyes

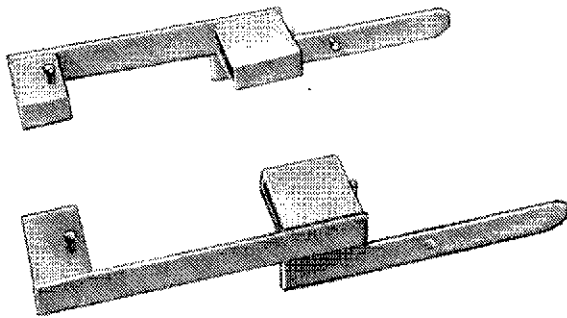

JDG-21 Fork Lift Adapters	To remove SOUND-GARD Body
---------------------------	---------------------------

R28518

Fig. 3—Fork Lift Adapters

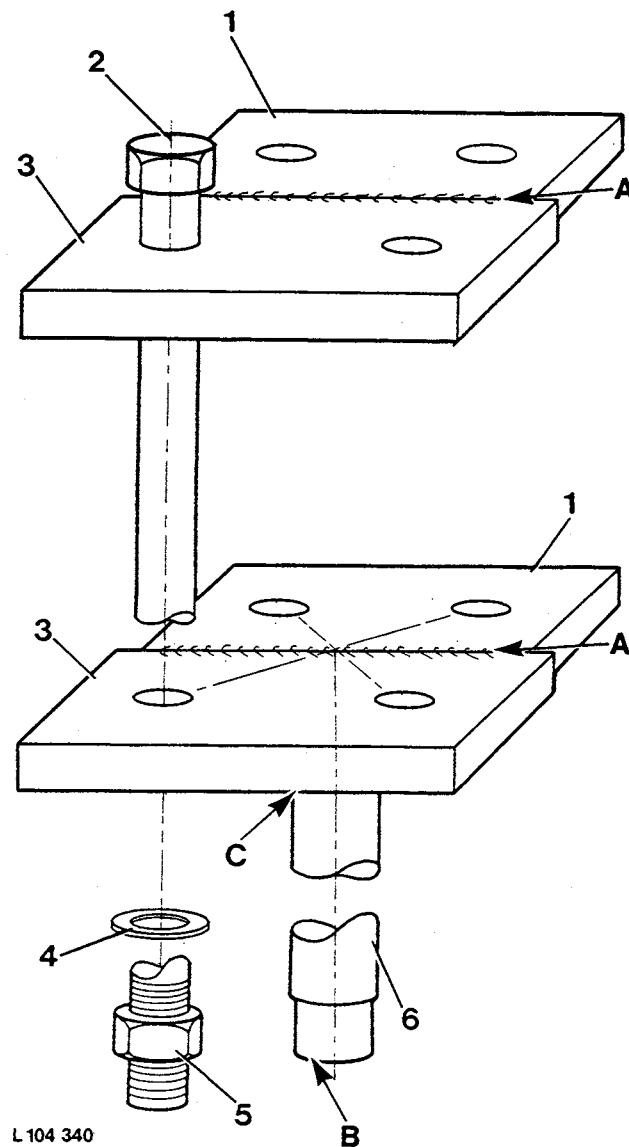

L 104 340

L104340

1. Weld both retaining plates together (A).
2. Adapter lug diameter to fit bore of trolley jack (B).
3. Weld round steel in center of both plates (C).

- 1—Retaining plate T25671 (2 used)
- 2—Cap screw L34163 (2 used)
- 3—Retaining plate T32429 (2 used)
- 4—Washer 24 H1402 (2 used)
- 5—Hex. nut 14H858 (2 used)
- 6—Round steel 50 x 250 mm (1.97 x 9.84 in.)

Fig. 4—Holding Device (Self-Manufacture) For Removal of Final Drive Assemblies

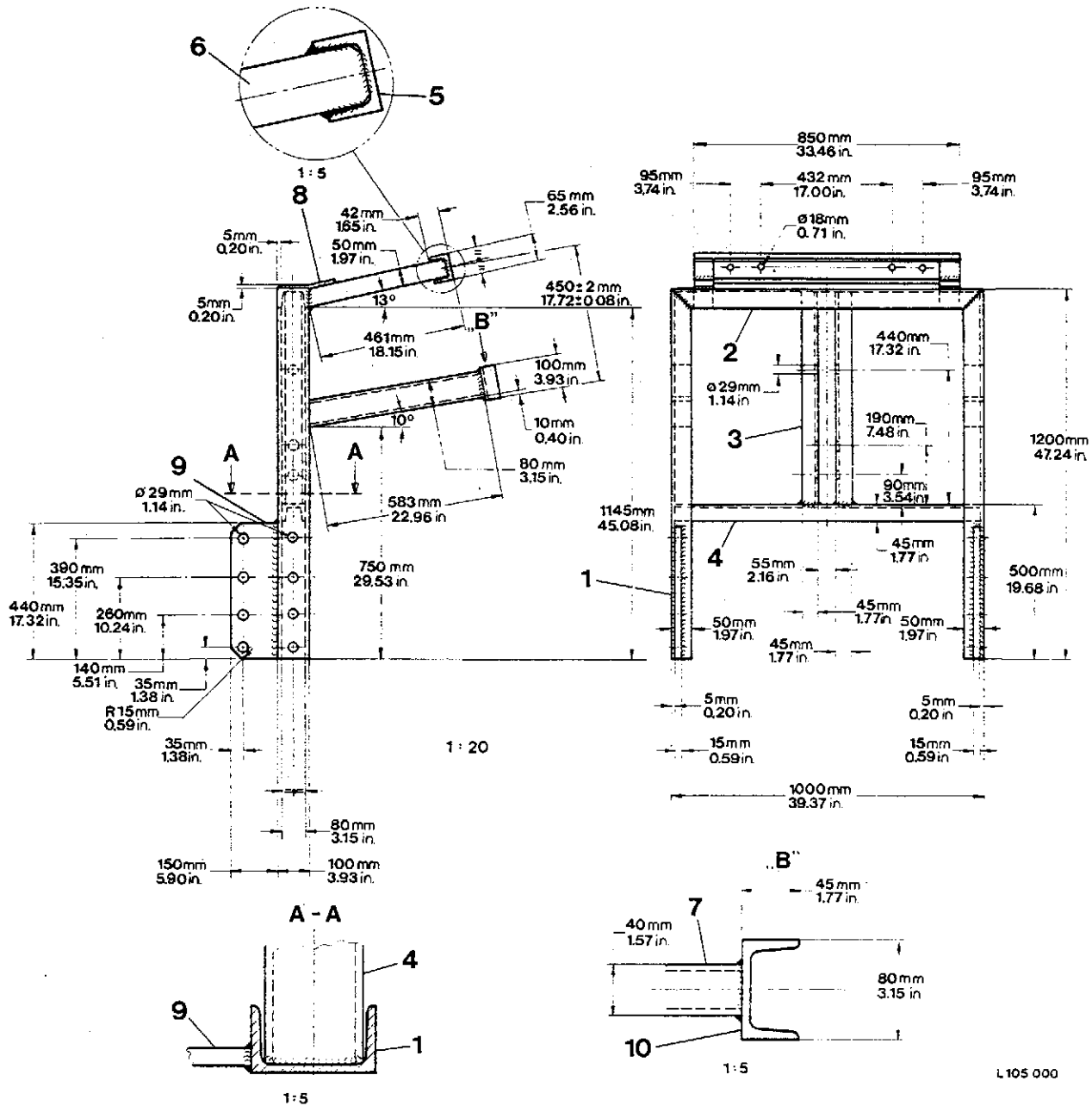

L105000

- 1—U-profile steel 100 x 1200 mm (3.94 x 47.24 in.) (2 used)
- 2—U-profile steel 100 x 1000 mm (3.94 x 39.37 in.) (1 used)
- 3—U-profile steel 80 x 694 mm (3.15 x 27.32 in.) (1 used)
- 4—U-profile steel 80 x 988 mm (3.15 x 38.9 in.) (1 used)
- 5—U-profile steel 65 x 850 mm (2.56 x 33.46 in.) (1 used)

- 6—Square steel 50 x 50 x 461 mm (1.97 x 1.97 x 18.15 in.) (2 used)
- 7—Square tubular steel 80 x 40 x 5 x 583 mm (3.15 x 1.58 x 0.2 x 22.95 in.) (2 used)
- 8—Flat steel 50 x 5 x 190 mm (1.97 x 0.2 x 7.48 in.) (2 used)
- 9—Flat steel 150 x 15 x 440 mm (5.9 x 0.59 x 17.32 in.) (2 used)
- 10—U-profile steel 80 x 100 mm (3.15 x 3.94 in.) (2 used)

Fig. 5—Lifting Device (Self-Manufacture) for Removal of SOUND-GARD Body

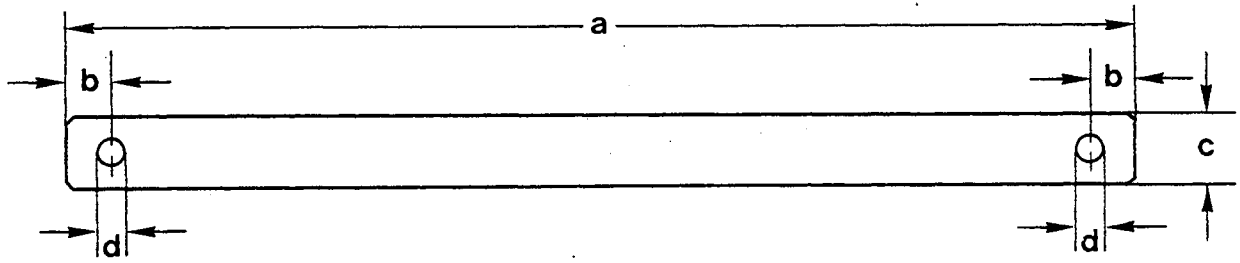

L105 887

L105887

A—1100 mm (43.31 in.)
 B—25 mm (0.98 in.)

C—Diameter 22 mm (0.87 in.) with Cat. I draft links
 29 mm (1.14 in.) with Cat. II draft links
 D—Diameter 5 mm (0.2 in.)

Fig. 6—Steel Shaft (Self-Manufacture) for SOUND-GARD body Lifting Device

Group 05 PREDELIVERY, DELIVERY AND AFTER-SALES INSPECTIONS

The John Deere Delivery Receipt, when properly filled out and signed by the dealer and customer, verifies that the predelivery and delivery services were satisfactorily performed. When delivering this machine, give the customer his copy of the delivery receipt and the operator's manual. Explain their purpose to him.

To promote complete customer satisfaction, a predelivery inspection including mending of possible shipping damage and giving the finishing touches to the tractor, is of prime importance to the dealer.

After the first 100 operating hours an inspection should be performed by the dealer to make sure that the tractor is in proper operating condition.

The predelivery and after-sale inspection check lists in the operator's manual will be completed by the dealer when the inspections are being performed. He will then forward them to the sales branch service department.

Tractor Storage

When storing a new tractor, proceed as follows:

Short-Term (Under 30 Days)

1. Fill fuel tank. This prevents condensation of moisture in tank.
2. Check engine oil level, transmission-hydraulic oil level, and coolant level. Add oil or coolant if necessary. During cold weather, be sure coolant contains sufficient anti-freeze.

3. Check electrolyte level in batteries. If electrolyte does not cover plates, add distilled water. Make sure batteries are fully charged.

4. Store tractor in a dry, protected place. If necessary to store tractor outside, cover it with a protective material. Protect tires from heat, sunlight, and petroleum products.

Long Term (Over 30 Days)

To protect engine, fuel system, transmission and hydraulic system, use the AR41785 rust inhibitor. The above part no. includes one can of rust inhibitor, masking tape and protective caps to cover all engine openings.

Protect the engine as follows:

1. Add 355 c.c. (12 oz.) of rust inhibitor to the engine oil.
2. Add 265 c.c. (9 oz.) of rust inhibitor to the oil in the transmission/hydraulic system.
3. Drain fuel tank, pour 235 c.c. (8 oz.) of rust inhibitor into the empty tank and add approx. 10 liters (2.6 U.S. gals.) of fuel. Start engine and operate it at fast idle for 15 to 20 minutes to distribute the mixture through the whole fuel system. While the engine is running, operate the complete hydraulic system several times. Shut off engine in time to leave some fuel in the tank. Then allow the engine to cool down for 15 to 20 minutes.
4. Prepare 15 c.c. (0.5 oz.) of rust inhibitor for each cylinder. Remove plug of intake manifold or connecting pipe of starting fluid adapter at the intake manifold, whichever applies.

Inject rust inhibitor into the intake manifold. Pull out shut-off knob and crank engine with starter several times.

However, do not allow the engine to start. Otherwise the whole procedure must be repeated.

After the rust inhibitor has been added, the engine may not be started again.

IMPORTANT: Rust inhibitor agents evaporate very easily. For this reason, seal all openings after the inhibitor has been added. Also, always keep the inhibitor container closed.

5. Fill the fuel tank.
6. Remove batteries. Add distilled water, if necessary. Charge the batteries and store in a cool, dry place where they will not freeze.
7. Seal all openings such as the vent tube and exhaust outlet.
8. Slacken fan belt and air conditioning compressor belt (if equipped).
9. Replace or repair damaged parts. Touch up any painted surfaces which are scratched or chipped.
10. Coat exposed metal surfaces, such as axles and piston rods of hydraulic cylinders, with grease or corrosion preventative.
11. Store the tractor in a dry, protected place. If the tractor is stored outside, cover it with a waterproof tarpaulin.
12. Block up the tractor so that tires do not touch the ground. Protect tires from heat and sunlight.

Removing the Tractor from Storage

1. Remove all protective coverings.
2. Check crankcase and transmission/hydraulic system oil levels.

3. Check coolant level.
4. Check tire inflation pressure.
5. Install batteries and connect cable and ground strap.
6. Adjust fan belt and compressor belt (if equipped) tension.
7. Carry out 500-hour check.
8. Run engine at approx. 1500 rpm for some minutes. Check all systems before placing tractor under load.

Predelivery Inspection

Before delivering the tractor to the customer, the following checks and services should be performed by the dealer:

Engine

LEAKS

1. Check engine and fuel lines for leaks. Repair as necessary.

CHECKING CRANKCASE OIL LEVEL

NOTE: Tractor should be on a level surface when oil level is checked. If it is not, check only to make sure the crankcase is not dry. Recheck oil level later, when tractor is on level ground.

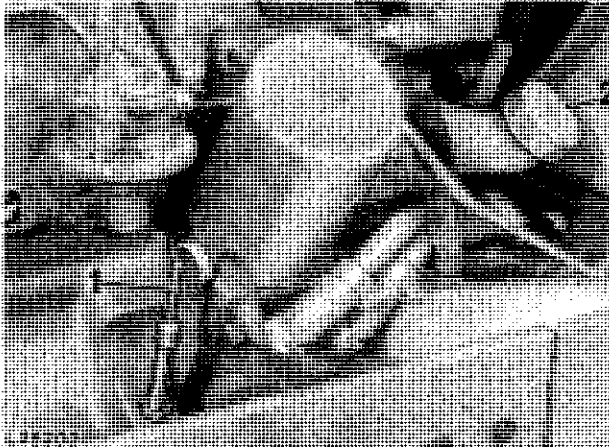

L35200

1—Dipstick

2—Filler Cap

Fig. 1—Engine Oil Dipstick and Filler Cap

1. Pull out dipstick (1, Fig. 1) and check oil level.
2. If necessary, add oil to bring oil level to top mark on dipstick. Use John Deere TORQ-GARD SUPREME engine oil SAE 10W-20 or an equivalent oil (see Group 10).

CHECKING COOLANT LEVEL

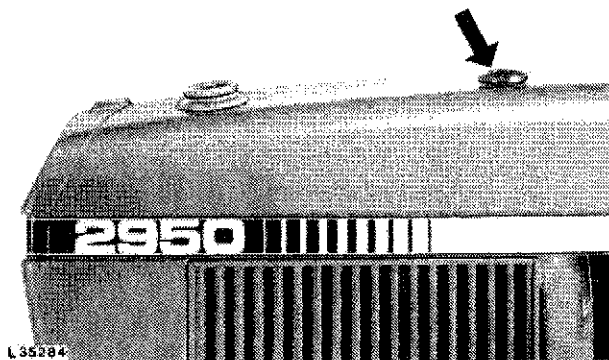

L35284

Fig. 2—Radiator Filler Cap

1. Remove radiator filler cap and check coolant level. Coolant level must be midway between the filler neck and top of radiator core.

2. If necessary, add coolant to obtain this level.

John Deere Engine Cooling Fluid is filled into the cooling system at the factory. It protects the engine against corrosion and against frost down to -36° (-35° F).

IMPORTANT: Use only John Deere Engine Cooling Fluid in the cooling system independent of the season.

If no John Deere Engine Cooling Fluid is available use a mixture of 50 percent ethylene-glycol antifreeze/anticorrosion inhibitor and 50 percent clear, soft water. This mixture guarantees engine protection against corrosion and against corrosion and against frost down to -36° C (-35° F).

Never use any cooling system sealing additives.

IDLE SPEEDS

1. Warm up engine to operating temperature and check slow and fast idle speeds. Adjust, if necessary (see Section 30, Group 20).
2. Slow idle speed: 700 to 800 rpm
3. Fast idle speed: 2610 to 2660 rpm

ENGINE SHUT-OFF CABLE

1. Check operation of shut-off cable. Move hand throttle lever completely forward and idle engine for 1 to 2 minutes.
2. Completely pull out shut-off knob, making sure engine stops immediately.
3. If necessary, adjust shut-off cable (see Section 30, Group 20).

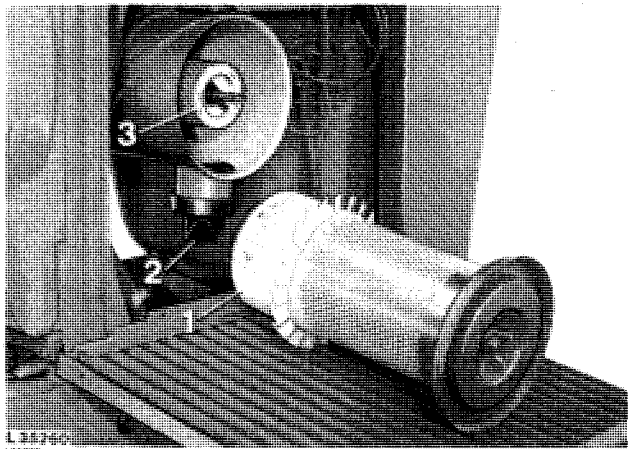
AIR CLEANER AND SAFETY ELEMENT

1—Air Cleaner Element 3—Safety Element
2—Dust Unloading Valve

Fig. 3 - Air Cleaner and Safety Element

1. Check air cleaner and safety elements for proper installation.
2. Make sure that dust unloading valve (2, Fig. 3) (rubber cap) is installed on air cleaner.

AIR INTAKE CONNECTIONS

1. Check air intake connections for tightness. Tighten any loose clamps.

EXHAUST STACK

1. Install exhaust stack, making sure it is in vertical position.
2. Install exhaust stack flap with flap hinge at the rear (as seen in direction of forward travel). When closed, flap should not contact exhaust stack end. If necessary, clamp flap to exhaust stack to obtain a clearance of 2 mm (0.08 in.) between flap and stack end.

CHECKING V-BELT TENSION**Fan Belt**

1. The fan belt should have 19 mm (3/4 in.) flex with 90 N (20 lb) pull midway between crankshaft and alternator or water pump (use a spring scale).

Compressor Belt (if equipped)

1. Compressor belt should deflect 6 mm (1/4 in.) when a 70 N (15 lb) force is applied midway between pulleys.

Electrical System**BATTERIES**

1. Check battery terminals and battery cable ends. If they are corroded, clean and coat them with petroleum jelly.
2. Check electrolyte level in each battery cell. Add distilled water if necessary to bring level above cell plates.
3. If batteries are not fully charged, charge them. Remove cell caps before charging the battery.

Important Notes

1. **If the engine is to be run for a short time without battery (using a slave battery for starting), do not, under any circumstances, interrupt the circuit by switching off the main switch before stopping the engine by means of the fuel pump shut-off cable. Further it is recommended to use additional current (lights) while engine is running. Do not run engine at a speed above 1000 rpm. Insulate battery end of disconnected starter cable properly to avoid damage to alternator and regulator.**

On tractors with SOUND-GARD Body: Do not connect ground strap of slave battery to cab.

2. Connect batteries or battery charger in the proper polarity (“+” and “-”). If they are improperly connected, the rectifier diodes will be immediately destroyed.

START SAFETY SWITCH

1. Move range shift lever into neutral position.
2. Check function of start safety switch. Replace switch when necessary (see Section 40, Group 15).

LIGHTING SYSTEM

1. Check lighting system and repair as necessary. Replace any defective bulbs (see Section 40, Group 20).
2. Check headlight adjustment and correct, if necessary (see Section 40, Group 20).

SOUND-GARD BODY CONTROLS

Fan Switch

1. Open air outlets. Check fan switch (2, Fig. 4) for proper operation.

Heater Switch

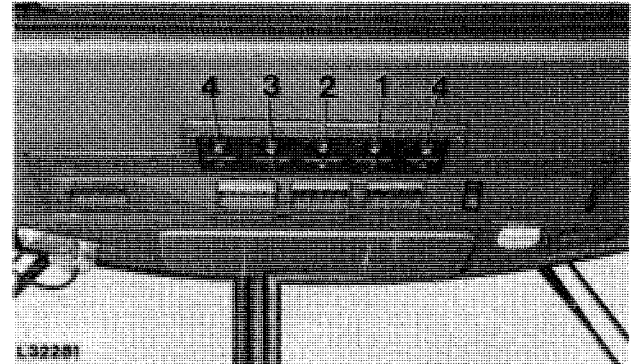

L32281

1—Heater Switch
2—Fan Switch

3—Thermostat Switch
(Air Conditioning)
4—Windshield Wiper Switch

Fig. 4 - SOUND-GARD Body Controls

1. With fan operating, check heater switch (1, Fig. 4) for proper operation. For this purpose, turn switch on tractors equipped with cab to the **right**. Making sure that warm air enters cab (with engine at operating temperature).

SOUND-GARD Body Thermostat Switch (Tractors with Air Conditioning)

1. With fan operating, check infinitely variable thermostat switch (if equipped) for proper operation. Turn off heater. Turn thermostat switch (3, Fig. 4) clockwise, making sure cool air enters cab. If switch does not operate correctly, see Section 90, Group 05.

Windshield Wiper Switch

1. Check windshield wiper switch for proper operation.

CONTROLS AND INSTRUMENTS

1. Check controls and instruments for proper operation.

Power Train

CHECKING TRANSMISSION/HYDRAULIC SYSTEM OIL LEVEL

1. With the tractor on level ground, run the engine 2 to 3 minutes.
2. Place range and gear shift lever in neutral position.
3. Apply handbrake.
4. Lower draft links.
5. Run engine at slow idle (750 rpm).

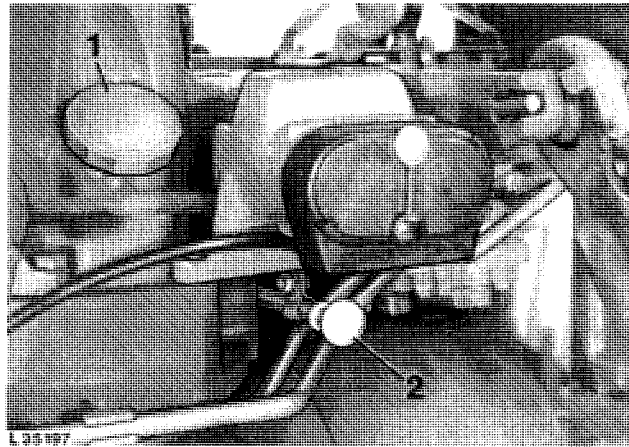

1—Filler Cap

2—Dipstick

Fig. 5 - Transmission/Hydraulic System Dipstick and Filler Cap

6. Pull out dipstick and wipe clean.
7. Insert dipstick. Remove dipstick and check oil level.
8. If necessary, add John Deere HY-GARD Transmission and Hydraulic Oil or equivalent oil to bring oil level to top mark on dipstick.

NOTE: Types of oil not meeting our specifications will not give satisfactory service and may result in eventual damage.

SYNCHRONIZED TRANSMISSION

1. Check transmission for proper operation.
2. While driving tractor, shift transmission through all gears. If transmission does not function properly, refer to Section 50, Group 30 or 35.

DIFFERENTIAL LOCK

1. Check differential lock for proper operation. If you find any problem, refer to Section 50, Group 40.

INDEPENDENT PTO

1. Check PTO operation. For this purpose, run engine and move PTO control lever to engaged and disengaged position. If PTO does not operate properly, refer to Section 50, Group 50.

HI-LO SHIFT UNIT

Check Hi-Lo shift unit as follows:

1. Operate tractor in both high and low ranges, carefully observing both operations.
2. Use the brakes to simulate a load condition on the tractor.
3. Low oil pressure will be indicated by disk pack slippage, which causes the clutch pack to become noisy.
4. A mechanical failure in the Hi-Lo shift unit will also be indicated by unusual noise.
5. If you find any problems, refer to Section 50, Group 20.

CREEPER TRANSMISSION

Check creeper function as follows:

1. Operate tractor, disengage engine clutch and shift creeper transmission in Range I and Reverse Range
2. Refer to Section 50, Group 25, if a malfunction occurs.

CLUTCH PEDAL

Tractors Without SOUND-GARD Body

1. Check clutch pedal free travel. It should be approx. 25 mm (1 in.).
2. Make sure that clutch is fully disengaged before pedal contacts stop bracket. Adjust clutch pedal free travel, if necessary (see Section 50, Group 10.)

Tractors with SOUND-GARD Body

1. Depress clutch pedal until it contacts stop. When doing this the operating rod should move 8.5 to 12.0 mm (5/16 to 15/32 in.) out of clutch operating cylinder.
2. When necessary, bleed clutch operating system (see Section 50, Group 10).

MECHANICAL FRONT WHEEL DRIVE

Checking Axle Housing Oil Level

1. Remove level plug (1, Fig. 6). Oil should be level with plug bore.
2. If necessary, top up with oil, using oil as specified in Group 10 of this section.

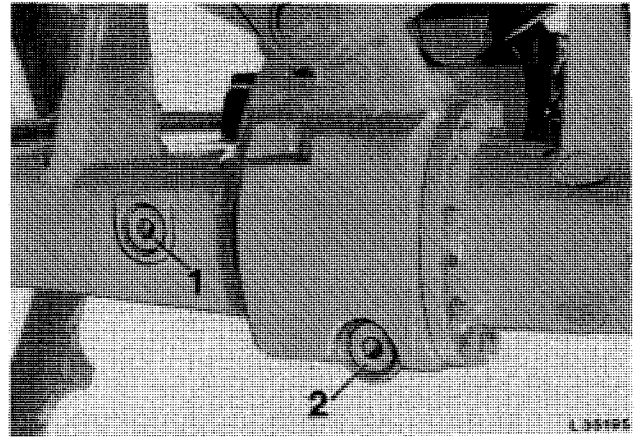

L35195

1—Level Plug

2—Drain Plug

Fig. 6—Checking Axle Housing Oil Level

Checking Wheel Hub Housing Oil Level

1. Turn wheel until mark (2, Fig. 7) is in level position.
2. Remove level plug (1). Oil should be level with plug bore.

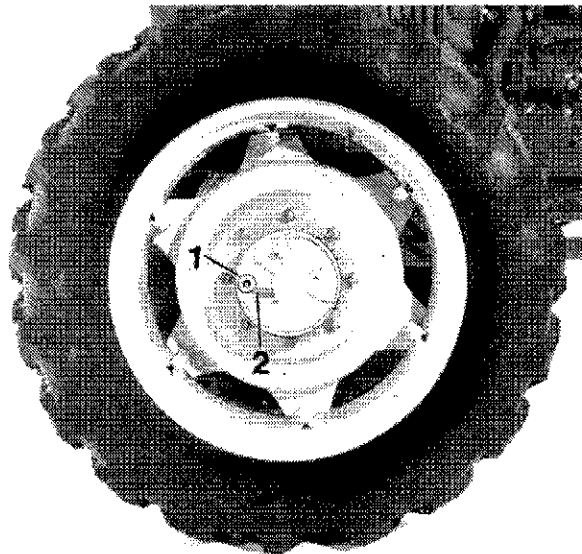

L 35196

L35196

1—Level Plug

2—Oil Level Mark

Fig. 7 - Checking Wheel Hub Housing Oil Level

3. Add oil, if necessary, using oil as specified in Group 10 of this section.

MFWD Operation

1. Check MFWD for proper operation. If you find any problems, refer to Section 50, Group 55.

Steering and Brakes

STEERING

1. Check steering system for proper operation. In case of a malfunction, refer to Section 60, Group 05.

BRAKES

1. Check footbrakes and handbrake for proper operation. Adjust brakes, if necessary. Refer to Section 60, Group 10 if a malfunction occurs.

Hydraulic System

THREE-POINT HITCH

1. Install and/or adjust draft links and center link (see Operator's Manual).

ROCKSHAFT

1. Check rockshaft operation. In case of a malfunction, refer to Section 70, Group 20.

SELECTIVE CONTROL VALVES

1. Check operation of selective control valves.

LEAKS

1. Check entire hydraulic system for leaks. Repair components when necessary.

Miscellaneous

WHEEL BOLTS

1. Tighten all wheel bolts to the specified torque. See Section 80, Group 10.

TIRE PRESSURES

1. Check tire pressures (see Operator's Manual).

TREAD WIDTH

1. Adjust tread width to customer's needs (see Operator's Manual).

TOE-IN

1. Check toe-in and adjust, if necessary (see Section 80, Group 05).

LUBRICATING POINTS

1. Lubricate all lubricating points on tractor.

ROLL GUARD

1. Check roll guard for proper installation.
2. Tighten cap screws to specified torque (see Section 90, Group 25).

GUARDS

1. Check all guards for proper installation.

DECALS AND PAINT

1. Check decals and paint for proper condition.

SOUND-GARD Body**AIR CONDITIONING SYSTEM**

1. Check operation of air conditioning system. If you find any problems, refer to Section 90, Group 05.
2. Check refrigerant lines for leaks. Repair or replace parts as necessary.

OPERATOR'S SEAT

1. Check whether operator's seat can be adjusted properly.
2. Check seat belt for proper condition and correct installation.

SOUND-GARD BODY

1. Check SOUND-GARD Body for proper installation.
2. Tighten attaching cap screws to specified torque, see Section 90, Group 20.

Delivery Inspection

A thorough discussion of the operation and service of the tractor at the time of its delivery helps to assure complete customer satisfaction.

Proper delivery should be an important part of the dealer's program.

It is a well-known fact that many complaints have arisen simply because the owner was not shown how to operate and service his new tractor properly. Therefore, enough time should be devoted, at the customer's convenience, to introducing him to his new tractor and explaining to him how to operate and service it.

Using the tractor Operator's Manual as a guide, be sure that the owner understands the following points properly:

1. Operation of control levers and instruments
2. Starting and shutting off the engine
3. The importance of the tractor break-in period
4. Use of counterweights and proper tire inflation pressure as well as filling of tires with water and calcium chloride, if required
5. All functions of the hydraulic system
6. Operating the PTO
7. The importance of the safety rules
8. The importance of lubrication and periodic service

Give particular emphasis to sway blocks, rockshaft speed-of-drop, rockshaft selector lever (load and height control), transmission oil pressure indicator light, engine oil pressure indicator light (whether temperature or pressure and what to do if lights go on), alternator indicator light (indicating whether alternator is charging) and operator's cab air filters. These areas are very often misunderstood.

After-Sales Inspection

In the interest of the purchaser and the dealer an after-sales inspection should be carried out by the dealer after the first 100 hours of using a new John Deere tractor.

The purpose of this inspection is to make sure that the customer is receiving satisfactory performance from his tractor. At the same time, the inspection should reveal whether or not the tractor is being operated, lubricated and serviced properly.

Through this inspection a needless volume of service work can be eliminated by preventing minor difficulties from developing into serious problems later on. It also will promote stronger dealer-customer relations and give the customer an opportunity to ask questions that may have arisen during the first few days of use.

Thereby the dealer has the further opportunity of promoting the possible sale of other new equipment.

The following inspection program is recommended:

Engine

LEAKS

1. Check engine and fuel lines for leaks. Repair as necessary.

OIL AND FILTER CHANGE

NOTE: Drain oil with engine shut off, however with engine oil warm.

1. Remove drain plug.
2. While oil is draining, replace filter element.

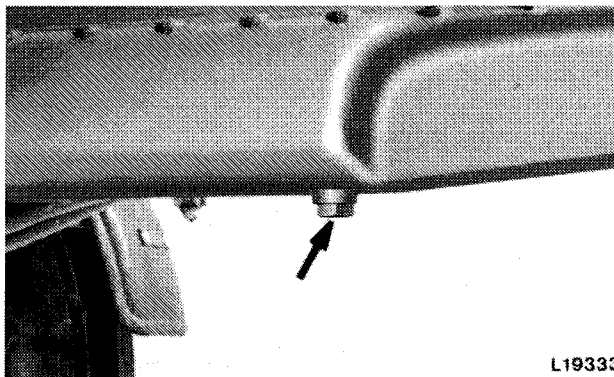

L19333

L19333

Fig. 8 - Crankcase Drain Plug

3. Remove filter element (turn counterclockwise) and clean mounting surface.
4. Apply a thin film of oil to sealing ring of new filter. Tighten filter element until sealing ring touches mounting surface, then turn an additional 1/2 or 3/4 turns. Do not overtighten.
5. Reinstall drain plug.
6. Fill crankcase with fresh oil of the proper viscosity (see Group 10).

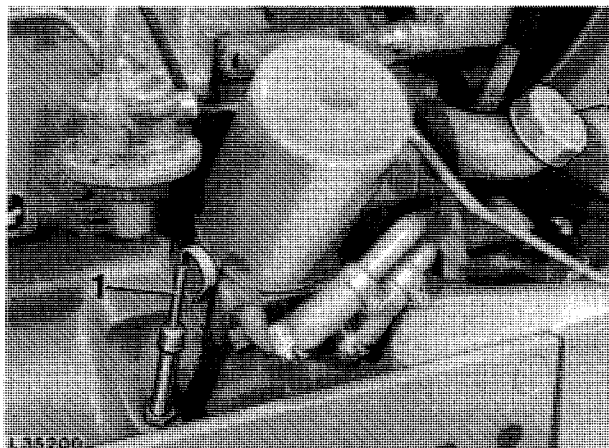

L95200

1—Dipstick

2—Filler Cap

Fig. 9 - Engine Oil Dipstick and Filler Cap

7. Crankcase capacity with filter change 11.5 liters (3.0 gal.).
8. Run engine for a short time and check for leaks at filter base and drain plug.
9. Stop engine.
10. Check oil level.

CHECKING VALVE CLEARANCE

1. Using a feeler gauge, check valve clearance (see CTM-4, Engines).

Valve clearance (with the engine cold or warm)

Intake valve	0.35 mm (0.014 in.)
Exhaust valve	0.45 mm (0.018 in.)

CHECKING COOLANT LEVEL

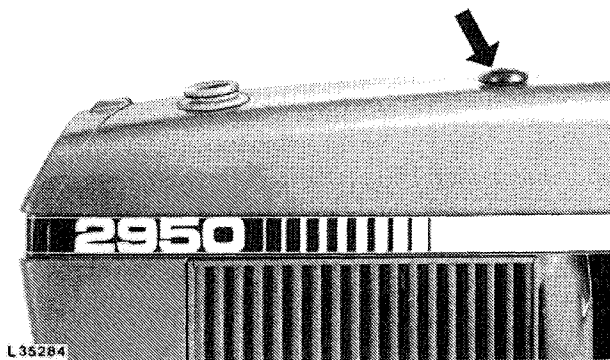

L35284

Fig. 10—Radiator Filler Cap

1. Remove radiator filler cap and check coolant level. Coolant level must be midway between the filler neck and top of radiator core.
2. If necessary, add coolant to obtain this level (see page 3).

IDLE SPEEDS

1. Warm up engine to operating temperature and check slow and fast idle speeds. Adjust, if necessary (see Section 30, Group 20).
2. Slow idle speed: 700 to 800 rpm
3. Fast idle speed: 2610 to 2660 rpm

HAND THROTTLE LEVER

1. Check whether hand throttle lever can be moved properly. Adjust, if necessary.

ENGINE SHUT-OFF CABLE

1. Check operation of shut-off cable. Move hand throttle lever completely forward and idle engine for 1 to 2 minutes.
2. Completely pull out shut-off knob, making sure engine stops immediately.
3. If necessary, adjust shut-off cable (see Section 30, Group 20).

AIR CLEANER AND SAFETY ELEMENT

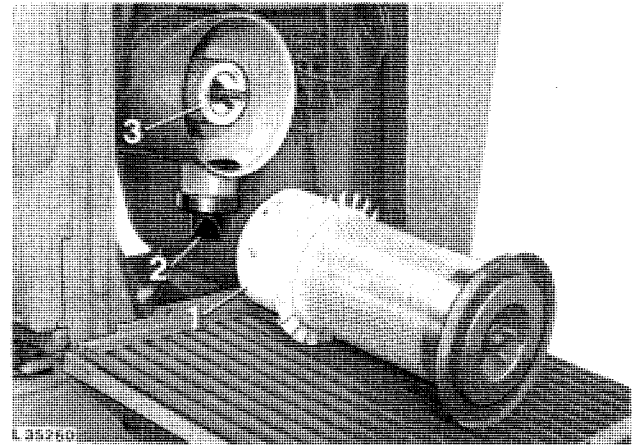

L35260

1—Air Cleaner Element 3—Safety Element
2—Dust Unloading Valve

Fig. 11—Air Cleaner and Safety Element

1. Check air cleaner and safety element for proper installation.
2. Make sure that dust unloading valve (2, Fig. 12) (rubber cap) is installed on air cleaner.

AIR INTAKE CONNECTIONS

1. Check air intake connections for tightness. Tighten any loose clamps.

CHECKING V-BELT TENSION

Fan Belt

1. The fan belt should have 19 mm (3/4 in.) flex with 90 N (20 lb) pull midway between crankshaft and alternator or water pump (use a spring scale).

Compressor Belt (if equipped)

1. Compressor belt should deflect 6 mm (1/4 in.) when 70 N (15 lb) force is applied midway between pulleys.

Electrical System

BATTERIES

1. Check battery terminals and battery cable ends. If they are corroded, clean and coat them with petroleum jelly.

2. Check specific gravity of battery cells. At an electrolyte temperature of 20°C (68°F), a fully charged battery should have a specific gravity of 1.28 under normal and arctic conditions and 1.23 in tropical areas.

3. Check electrolyte level in each battery cell. Add distilled water if necessary to bring level above cell plates.

4. If batteries are not fully charged, charge them. Remove cell caps before charging the battery.

Important Notes

1. If the engine is to be run for a short time without battery (using a slave battery for starting), do not, under any circumstances, interrupt the circuit by switching off the main switch before stopping the engine by means of the fuel pump shut-off cable. Further it is recommended to use additional current (lights) while engine is running. Do not run engine at a speed above 1000 rpm. Insulate battery end of disconnected starter cable properly to avoid damage to alternator and regulator.

On tractors with SOUND-GARD Body: Do not connect ground strap of slave battery to cab.

2. Connect batteries or battery charger in the proper polarity (“+” and “-”). If they are improperly connected, the rectifier diodes will be immediately destroyed.

START SAFETY SWITCH

1. Move range shift lever into neutral position.
2. Check function of start safety switch. Replace switch when necessary (See Section 40, Group 15).

LIGHTING SYSTEM

1. Check lighting system and repair if necessary. Replace any defective bulbs (see Section 40, Group 20).
2. Check headlight adjustment and correct, if necessary (see Section 40, Group 20).

SOUND-GARD BODY CONTROLS

Fan Switch

1. Open air outlets. Check fan switch (2, Fig. 12) for proper operation.

Heater Switch

1. With fan operating, check heater switch (1, Fig. 12) for proper operation. For this purpose, turn switch to the right, making sure that warm air enters cab (with engine at operating temperature).

If this is not the case, replace heater switch. If necessary, check coolant flow through heater core (see Section 90, Group 10).

Thermostat Switch (Tractors with Air Conditioning)

1. With fan operating, check infinitely variable thermostat switch (if equipped) for proper operation. Turn off heater. Turn thermostat switch (3, Fig. 12) clockwise, making sure cool air enters cab. If switch does not operate correctly, see Section 90, Group 05.

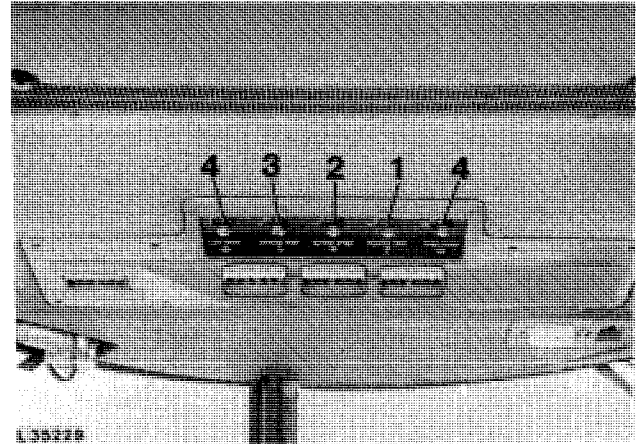

1—Heater Switch
2—Fan Switch

3—Thermostat Switch
(Air Conditioning)
4—Windshield Wiper Switch

Fig. 12 - SOUND-GARD Body Controls

Windshield Wiper Switch

1. Check windshield wiper switch for proper operation.

CONTROLS AND INSTRUMENTS

1. Check controls and instruments for proper operation.

Power Train

CHECKING TRANSMISSION/HYDRAULIC SYSTEM OIL LEVEL

1. With the tractor on level ground, run the engine 2 to 3 minutes.
2. Place range and gear shift lever in neutral position.
3. Apply handbrake.
4. Lower draft links.
5. Run engine at slow idle (700 to 800 rpm).

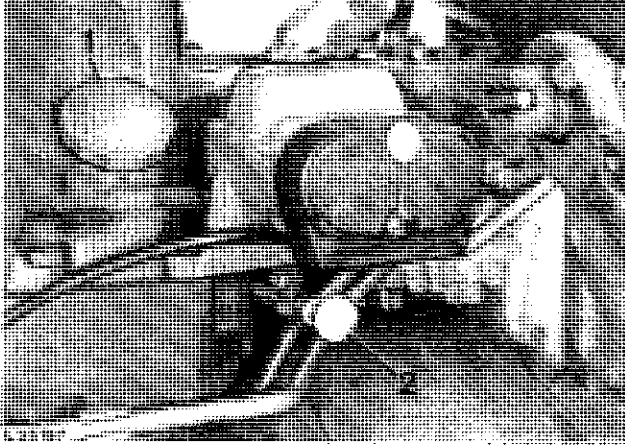

L35197

1—Filler Cap

2—Dipstick

Fig. 13 - Transmission/Hydraulic System Dipstick and Filler Cap

6. Pull out dipstick and wipe clean.
7. Insert dipstick. Remove dipstick and check oil level.
8. If necessary, add John Deere HY-GARD Transmission and Hydraulic Oil or equivalent oil (see Group 10) to bring oil level to top mark on dipstick.

NOTE: Types of oil not meeting our specifications will not give satisfactory service and may result in eventual damage.

SYNCHRONIZED TRANSMISSION

1. Check transmission for proper operation.
2. While driving tractor, shift transmission through all gears. If transmission does not function properly, refer to Section 50, Group 30 and 35.

DIFFERENTIAL LOCK

1. Check differential lock for proper operation. If you find any problem, refer to Section 50, Group 40.

INDEPENDENT PTO

1. Check PTO operation. For this purpose, run engine and move PTO control lever to engaged and disengaged position. If PTO does not operate properly, refer to Section 50, Group 50.

HI-LO SHIFT UNIT

Check Hi-Lo shift unit as follows:

1. Operate tractor in both high and low range, carefully observing both operations.
2. Use the brakes to simulate a load condition on the tractor.
3. Low oil pressure will be indicated by disk pack slippage, which causes the clutch pack to become noisy.
4. A mechanical failure in the Hi-Lo shift unit will also be indicated by unusual noise.
5. If you find any problems, refer to Section 50, Group 20.

CREEPER TRANSMISSION

Check creeper transmission function as follows:

1. Operate tractor, disengage engine clutch and shift creeper transmission in Range I and Reverse Range.
2. Refer to Section 50, Group 25, if a malfunction occurs.

CLUTCH PEDAL

Tractors without SOUND-GARD Body

1. Check clutch pedal free travel. It should be approx. 25 mm (1 in.)
2. Make sure that clutch is fully disengaged before pedal contacts stop bracket. Adjust clutch pedal free travel, if necessary (see Section 50, Group 10).

Tractors with SOUND-GARD Body

1. Depress clutch pedal until it contacts stop. When doing this the operating rod should move 8.5 to 12.0 mm (5/16 to 15/32 in.) out of clutch operating cylinder.
2. When necessary, bleed clutch operating system (see Section 50, Group 10).

MECHANICAL FRONT WHEEL DRIVE

Axle Housing Oil Change

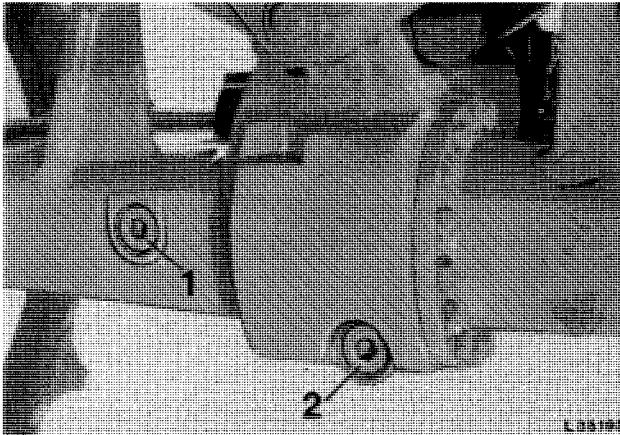

L35195

1—Level Plug

2—Drain Plug

Fig. 14 - Axle Housing

1. Remove drain plug (2, Fig. 14) and drain oil.
2. Reinstall drain plug and tighten securely.
3. Remove level plug. Fill with fresh oil (7.0L;1.85 U.S. gal.) up to level oil plug bore. Reinstall level (filler) plug.

Wheel Hub Housing Oil Change

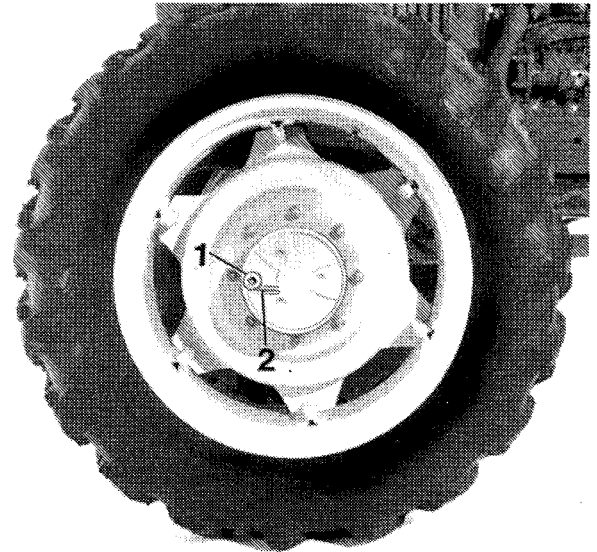

L 35196

L35196

1—Level Plug

2—Oil Level Mark

Fig. 15 - Wheel Hub Housing

1. Turn wheel until level plug (1, Fig. 15) is at the bottom. Remove plug and drain oil.
2. Turn wheel until mark (2) is in level position.
3. Fill fresh oil (approx. 0.75 liter;0.20 U.S. gal.) through plug bore. Use EP transmission oil according to specifications given in Group 10. Oil must be level with plug bore.
4. Reinstall level plug (1).

NOTE: Drain oil immediately after having operated the tractor for some time when the oil is still warm.

Group 10 LUBRICATION AND SERVICE

Effective use of lubricating oils and greases is perhaps the most important step toward low upkeep costs, long tractor life, and satisfactory service. Use only lubricants specified in this section.

Engine Lubricating Oil

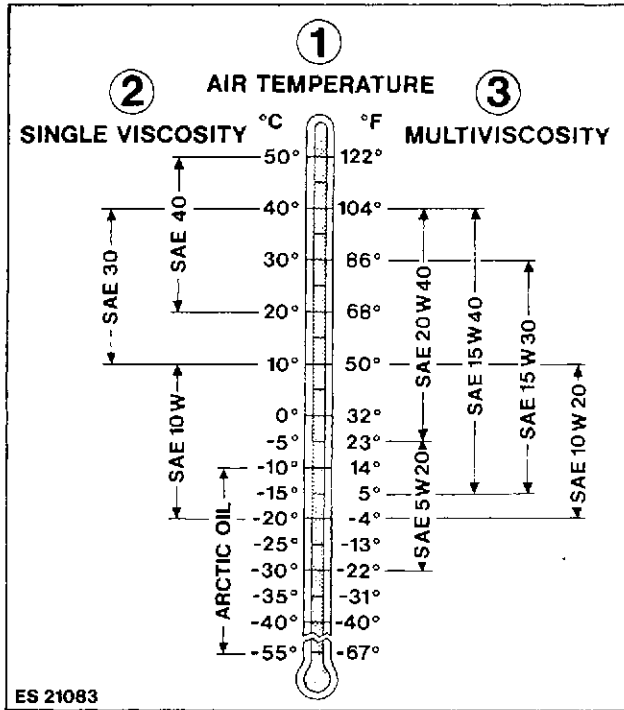

Fig. 1 - Oil Viscosity at Expected Temperature

NOTE: Depending on the lowest expected atmospheric temperature at start for the fill period, use oil of viscosity as shown in Fig. 1.

John Deere TORQ-GARD SUPREME® engine oil or John Deere HD Engine Oil is recommended. If other oils are used, they must be premium engine oils meeting performance requirements of:

- API Service Classification CD/SC
- Military Specification MIL-L-2104C

For low temperature operation, where oils meeting the above requirements may not be available in

appropriate viscosity grade, oils meeting the performance requirements of API Service Classification CC/SC or Military Specification MIL-L-46152 or MIL-L-46167 (Arctic Oil) may be used but at shorter drain intervals.

Quality engine oils are blended, so additives are neither required nor recommended.

NOTE: Some increase in oil consumption may be expected when SAE 5W-20 or Arctic Oils are used. Check oil level more frequently.

Transmission-Hydraulic Oil

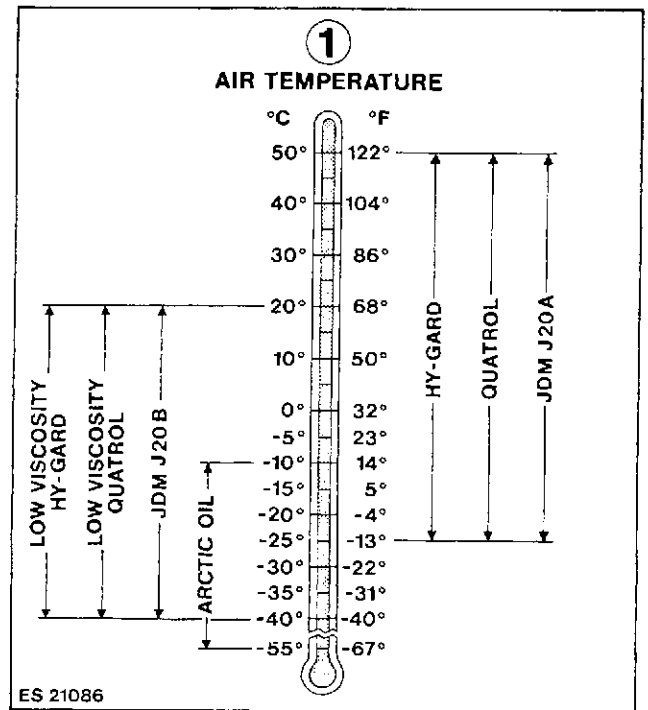

Fig. 2 - Oil Viscosity at Expected Temperature

John Deere HY-GARD® transmission and hydraulic oil is recommended.

You may also use QUATROL® oil, or other oils meeting John Deere Standard JDM J20A or JDM J20B.

For temperatures below -40°C (-40°F) use Arctic Oil (API-CC/SC, MIL-L-46167).

Oil for Mechanical Front Wheel Drive

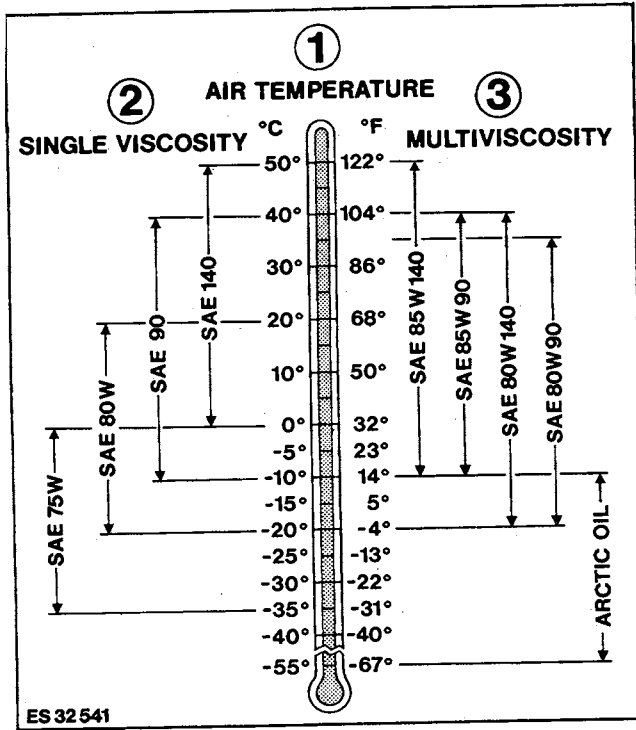

ES32541

Fig. 3 - Oil Viscosity at Expected Temperature

John Deere API GL-5 gear oil is recommended.

You may also use other EP transmission oils meeting performance requirements of:

- API Service Classification GL-5
- Military Specification MIL-L-2105B
- Military Specification MIL-L-2105C

At temperature below -35°C (-31°F) use Arctic Oil (API-CC/SC, MIL-L-10324A).

Brake Fluid for Hydraulic Operated Clutch

For tractors with hydraulic operated clutch (tractors with SOUND-GARD Body), use brake fluid meeting SAE standard J 1703.

Grease

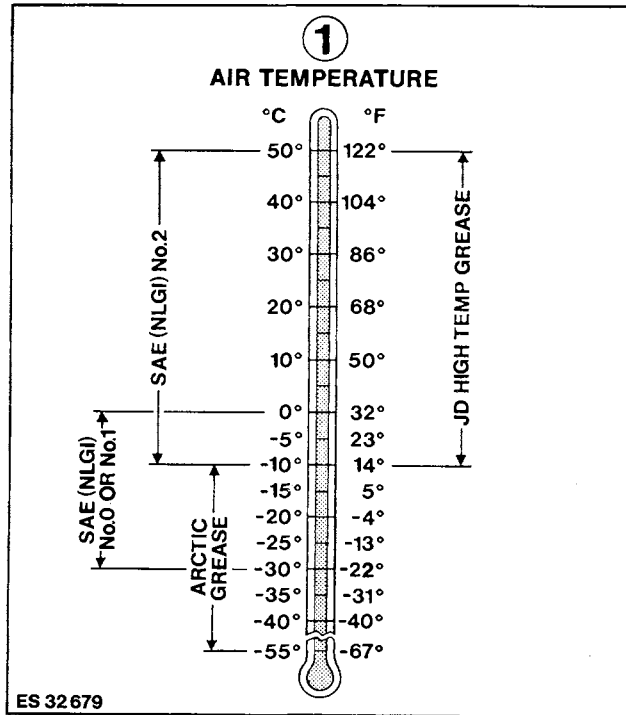

ES 32679

Fig. 4 - Grease To Be Used At Expected Temperature

John Deere High Temperature EP Multipurpose Grease is recommended for all grease fittings. If other greases are used, use:

- SAE EP Multipurpose Grease

At temperature below -30°C (-22°F) use Arctic Grease (MIL-G-10924 C).

Grease must be free of dust and other contamination.

Grease the tractor only when the engine is not running!

Clean grease fittings prior to greasing!

Storing Lubricants

The tractor can operate at top efficiency only if clean lubricants are used. Use clean containers to handle all lubricants. Store them in an area protected from dust, moisture, and other contamination.

Cooling Fluid

John Deere Engine Cooling Fluid is filled into the cooling system at the factory. It protects the engine against corrosion and against frost down to -36°C (-35°F).

If no John Deere Engine Cooling Fluid is available use a mixture of 50% ethylene-glycol antifreeze/anticorrosion inhibitor and 50% clear, soft water. This mixture guarantees engine protection against corrosion and against frost down to -36°C (-35°F).

Never use any cooling system sealing additives.

IMPORTANT: Use only John Deere Cooling Fluid in the cooling system, independent of the season. Drain system and refill with fresh coolant every 2 years.

General Information

Carefully written and illustrated instructions are included in the tractor Operator's Manual. Remind your customer to follow the recommendations in these instructions.

For your convenience when servicing the tractor, the following chart shows capacities for the various components.

Component	Capacity	Service Interval
Engine crankcase	Without filter change: 11 L (2.9 U.S. gal.) With filter change: 11.5 L (3.0 U.S. gal.)	Every 10 operating hours: check oil level Every 100 operating hours: oil change Every 200 operating hours: filter change*
Cooling system	Without SOUND-GARD Body: 17.0 L (4.5 U.S. gal.) With SOUND-GARD Body 19.0 L (5.0 U.S. gal.)	Change coolant every two years
Transmission/hydraulic system (including oil reservoir and oil cooler)	Dry system: 68.0 L (18.00 U.S. gal.) Oil change: 60.0 L (15.9 U.S. gal.)	Every 50 operating hours: check oil level Every 500 operating hours: filter change** Every 1000 operating hours: oil change Every 1000 operating hours: change hydrostatic steering filter Every 1000 operating hours: clean hydraulic pump stroke control valve filter
Mechanical front wheel drive	Axle housing: 7.0 L (1.85 U.S. gal.) Wheel Hub Housing 0.75 L (0.2 U.S. gal.) each	Every 100 operating hours: check oil level Every 1000 operating hours: oil change***
Hydraulic operated clutch (Tractors with SOUND-GARD Body)	500 cm ³ (17.5 fl. oz.)	Change brake fluid every year

* Replace crankcase filter element after the first 100 and 200 hours of operation. Thereafter replace filter element after every 200 hours of operation.

** Replace transmission/hydraulic filter element after the first 50 hours of operation, after the first 500 and thereafter every 500 hours of operation.

*** On tractors with MFWD, first oil change after 100 hours of operation. Thereafter every 1000 hours of operation.

Component	Lubricant	Service Interval
Clutch throw-out bearing (when equipped with grease fitting) ...	John Deere High Temperature EP multipurpose grease	Every 100 operating hours:
Front wheel bearings	John Deere High Temperature EP multipurpose grease or SAE EP multipurpose grease	Every 1000 operating hours: clean and pack with grease
Grease fittings		
Front axle and front wheels		Every 50 operating hours: lubricate
Mechanical front wheel drive universal jointed shaft		Every 50 operating hours: lubricate
Rear axle bearings		In extremely wet and muddy conditions; lubricate every 10 operating hours. Under normal conditions; lubricate every 500 operating hours
Three-point hitch		Every 200 operating hours: lubricate

Engine Crankcase

CHECKING OIL LEVEL

With the tractor on level ground and the engine stopped for 10 minutes or more, check crankcase oil level. If the oil level is down to the lower mark on the dipstick, add sufficient John Deere TORQ-GARD Supreme Engine Oil or its equivalent of the proper viscosity to bring the level to the upper mark.

Service Interval: At predelivery and after every 10 hours.

OIL AND FILTER CHANGE

NOTE: Drain oil with engine shut off, however with engine oil warm.

1. Remove drain plug.
2. While oil is draining, replace filter element (every 200 hours).

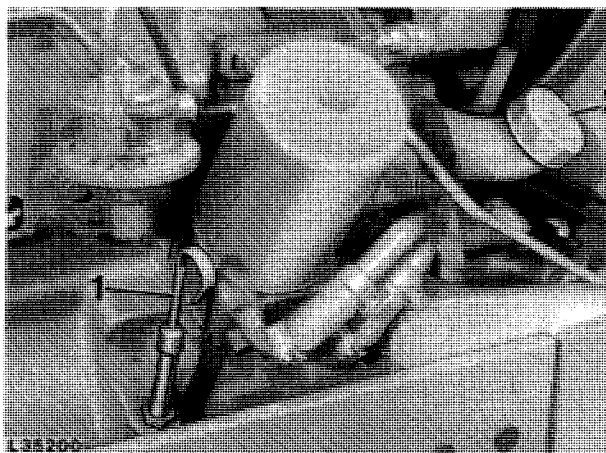

L35200

1—Dipstick

2—Filler Cap

Fig. 5—Engine Oil Dipstick and Filler Cap

3. Remove filter element (turn counterclockwise) and clean mounting surface.

4. Apply a thin film of oil to sealing ring of new filter. Tighten filter element until sealing ring touches mounting surface, then turn an additional 1/2 to 3/4 turns. Do not overtighten.
5. Reinstall drain plug.
6. Fill crankcase with fresh oil of the proper viscosity.

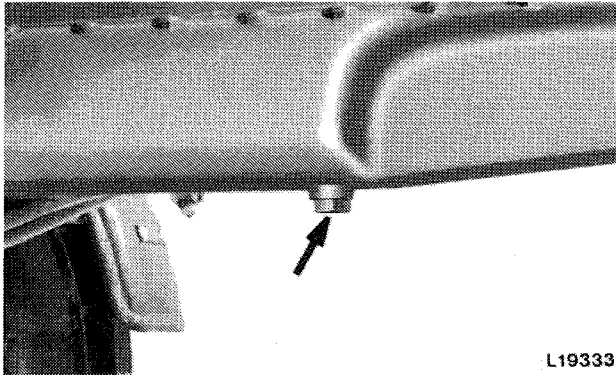

L19333

L19333

Fig. 6 - Crankcase Drain Plug

7. Crankcase capacity without filter change 11.0 liters (2.9 U.S. gal.), with filter change 11.5 liters (3.0 U.S. gal.).
8. Run engine for a short time and check for leaks at filter base and drain plug.
9. Stop engine.
10. Check oil level.

IMPORTANT: During cold weather operation with temperature below freezing point, change oil every 100 hours or every six weeks, whichever occurs first. Also change oil at any seasonal change in temperature when oil of a new viscosity is required.

Service Interval: Every 100 hours.

Transmission/Hydraulic System

CHECKING OIL LEVEL

1. With the tractor on level ground, run the engine 2 to 3 minutes.
2. Place range and gear shift lever in neutral position.
3. Apply handbrake.
4. Lower draft links.
5. Run engine at slow idle (700 to 800 rpm).

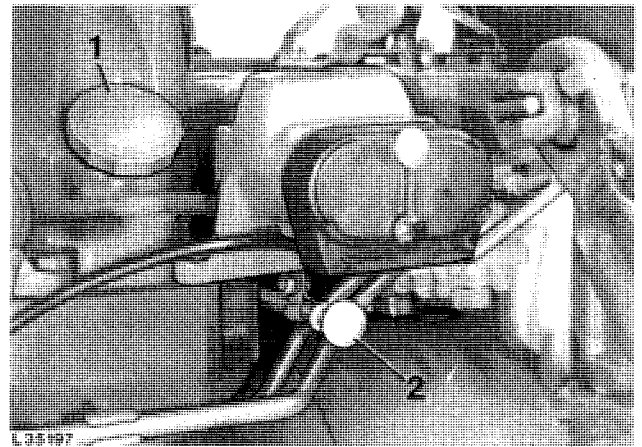

L35197

1—Filler Cap

2—Dipstick

Fig. 7 - Transmission/Hydraulic System Dipstick and Filler Cap

6. Pull out dipstick and wipe clean.
7. Insert dipstick. Remove dipstick and check oil level.
8. If necessary, add John Deere HY-GARD Transmission and Hydraulic Oil or equivalent oil to bring oil level to top mark on dipstick.

NOTE: Types of oil not meeting our specifications will not give satisfactory service and may result in eventual damage.

Service Interval: At predelivery and every 50 hours.

FILTER CHANGE

Transmission/Hydraulic Oil Filter

1. Disconnect selective control valve return line at transmission oil filter port.
2. Remove retaining screw (3, Fig. 8) and lift out filter cover (2).

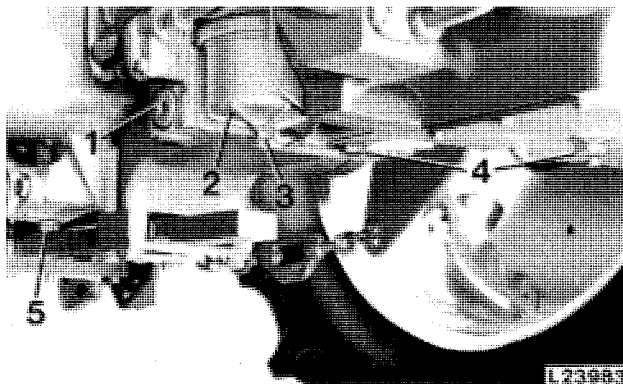

L23983

- | | |
|-------------------|--------------------|
| 1—Plug | 4—Front Drain Plug |
| 2—Filter Cover | 5—Rear Drain Plug |
| 3—Retaining Screw | |

Fig. 8 - Transmission/Hydraulic Oil Filter

3. Remove element and packing.
4. Install new packing coated with grease in transmission case groove.
5. Insert new element and reinstall filter cover (2, Fig. 8).
6. Tighten retaining screw (3) to 75 N·m (55 ft-lb) torque.
7. Connect selective control valve return line at transmission oil filter port.

Hydrostatic Steering Filter (Tractors without SOUND-GARD Body)

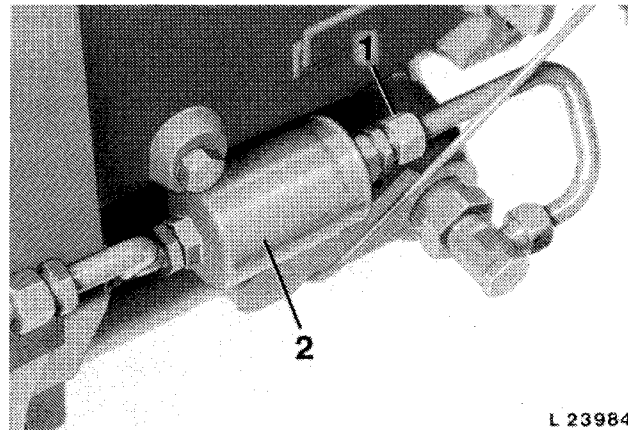

L23984

L 23984

- | | |
|-------------|----------|
| 1—Union Nut | 2—Filter |
|-------------|----------|

Fig. 9 - Hydrostatic Steering Filter

1. Remove union nut (1, Fig. 9) from return line.
2. Unscrew filter (2) out of line.
3. Install new filter and tighten union nut.

Service Interval: Every 1000 hours.

OIL CHANGE

1. Start engine and operate hydraulic functions to heat transmission oil to operating temperature.
2. Shut off engine.
3. Remove drain plugs (4 and 5, Fig. 8).

NOTE: On tractors with MFWD, also remove drain plug (1, Fig. 10) from clutch housing.

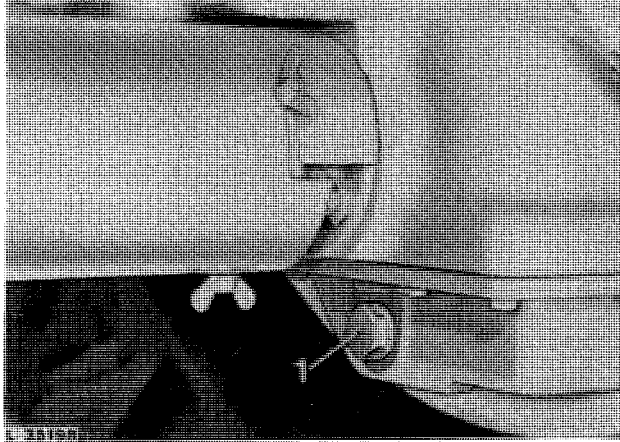

L35198

1—Drain Plug

Fig. 10 - Clutch Housing Drain Plug (on Tractors with MFWD)

4. Replace transmission/hydraulic system filter element (see Filter Change).
5. Remove plug (1, Fig. 8), pull out intake screen and wash in fuel.
6. *On tractors without SOUND-GARD Body*, replace hydrostatic steering filter (2, Fig. 9) (see Filter Change).
7. Remove hydraulic pump filter screen and clean. Reinstall filter screen and tighten plug.
8. Before filling with fresh oil, reinstall intake screen. Reinstall drain plugs and tighten to 135 N·m (100 ft-lb) torque. Use new seal rings.
9. Refill system with transmission/hydraulic oil to top mark on dipstick.
10. Run engine for 2 to 3 minutes, then recheck oil level.
11. Check oil level with engine running at slow idle, tractor standing on level ground, transmission in neutral, lift arms lowered and clutch engaged.

Service Interval: Every 1000 hours.

Mechanical Front Wheel Drive

CHECKING WHEEL HUB HOUSING OIL LEVEL

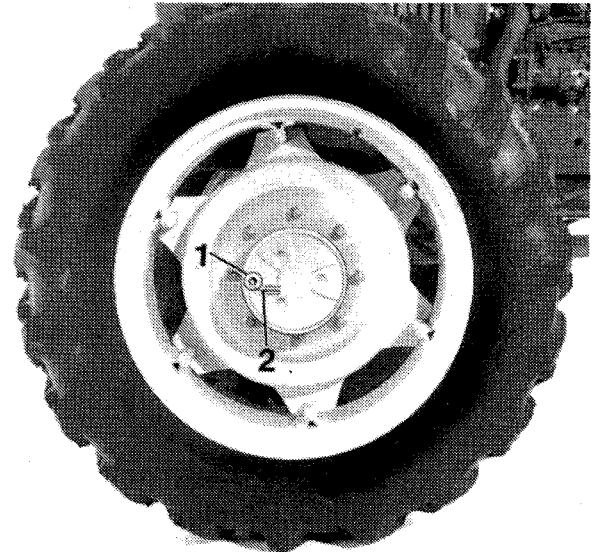

L 35196

L35196

1—Level Plug

2—Oil Level Mark

Fig. 11 - Checking Wheel Hub Housing Oil Level

1. Turn wheel until mark (2, Fig. 11) is in level position.
2. Remove level plug (1). Oil should be level with plug bore.
3. Add oil, if necessary, using EP transmission oil according to specifications (see page 2).

CHECKING AXLE HOUSING OIL LEVEL

1. Remove level plug (1, Fig. 12). Oil should be level with plug bore.
2. If necessary, top up with oil, using EP transmission oil according to specifications (see page 2).

Service Interval: Every 100 hours.

AXLE HOUSING OIL CHANGE

1. Remove drain plug (2, Fig. 12) and drain oil.
2. Reinstall drain plug and tighten securely.
3. Remove filler plug. Fill with fresh oil (7.0 L; 1.85 U.S. gal.) up to level of plug bore. Reinstall filler plug.

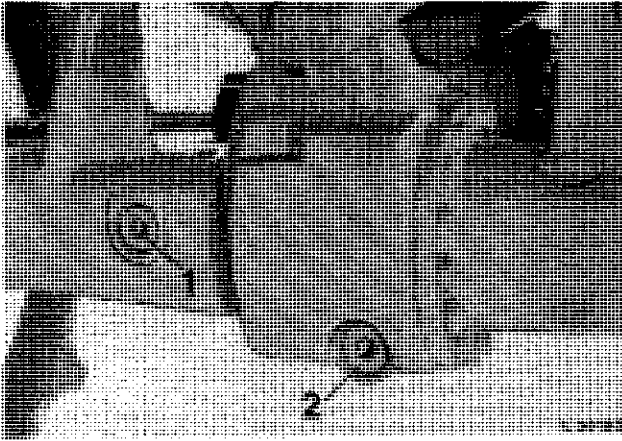

L95185

1—Level Plug

2—Drain Plug

Fig. 12 - Axle Housing

WHEEL HUB HOUSING OIL CHANGE

1. Turn wheel until level plug (1, Fig. 11) is at the bottom. Remove plug and drain oil.
2. Turn wheel until mark (2, Fig. 11) is in level position.
3. Fill with fresh oil (0.75 L; 0.20 U.S. gal.) through drain plug bore. Use EP transmission oil according to specifications (see page 2).
4. Check oil level. Reinstall level plug and tighten securely.

NOTE: Drain oil immediately after having operated the tractor for some time when the oil is still warm.

Service Interval: Change oil every 1000 hours.

Front Wheel Bearings**CLEANING AND PACKING BEARINGS**

1. Jack up front axle.
2. Remove hub cap. Remove cotter pin and slotted nut.
3. Disassemble parts. Clean parts in solvent and dry with compressed air.
4. Inspect parts carefully for damage. Replace bearings if they are worn. Replace oil seal and oil seal cup if grooves are worn in cup.
5. Pack bearings liberally with grease. Coat seal with John Deere EP multipurpose grease or SAE EP multipurpose grease.
6. Reassemble parts. Tighten slotted nut until a slight drag is felt when wheel is turned. back nut off just enough to insert cotter pin in first hole.
7. Reinstall hub cap.

Service Interval: Every 1000 hours.

Lubricating Points

IMPORTANT: Thoroughly clean all grease fittings prior to greasing and replace damaged grease fittings immediately.

CLUTCH THROW-OUT BEARING (when equipped with grease fitting)

Lubricate clutch throw-out bearing with three strokes of grease gun. High temperature John Deere EP multipurpose grease must be used.

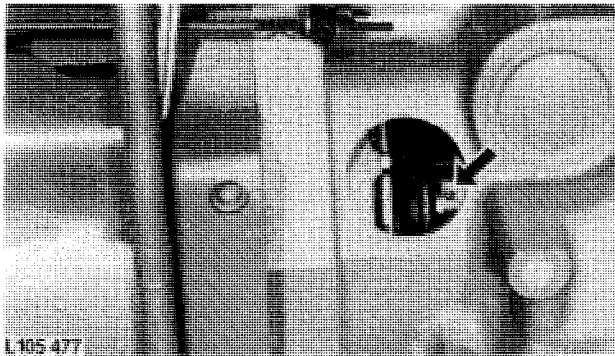

L105477

Fig. 13—Throw-out Bearing Grease Fitting
(Tractor without SOUND-GARD Body shown)

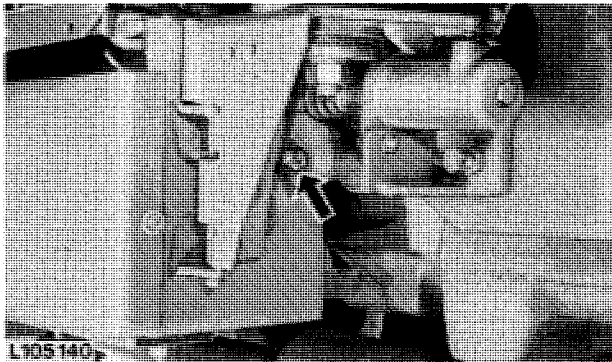

L150140

Fig. 14—Throw-out Bearing Grease Fitting
(Tractor with SOUND-GARD Body shown)

Service Interval: Every 100 hours

Lubricate grease fittings shown in Fig. 15 and 19 every 50 hours of operation. Use John Deere EP multipurpose grease.

LUBRICATING FRONT AXLE AND FRONT WHEELS (TRACTORS WITHOUT FRONT WHEEL DRIVE)

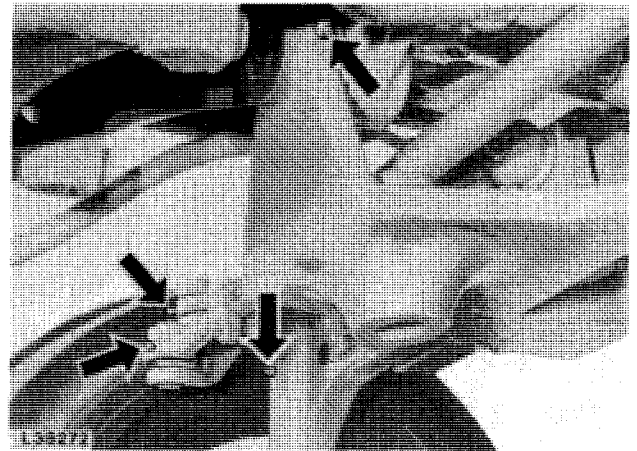

L35272

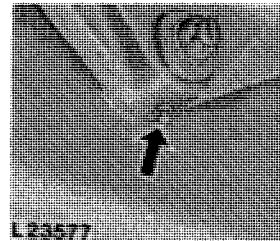

L23577

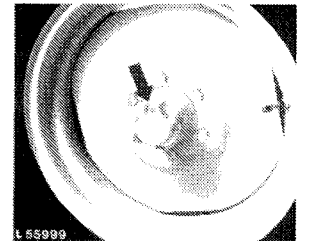

L55999

Fig. 15 - Front Axle and Front Wheel Grease Fittings

Service Interval: At predelivery and every 50 hours.

LUBRICATING FRONT AXLE (TRACTORS WITH MFWD)

Mechanical Front Wheel Drive

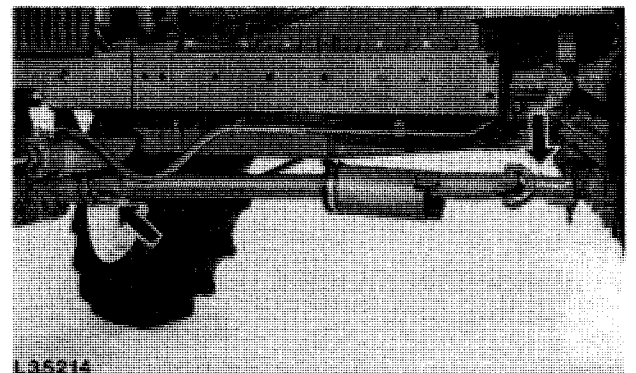

L35214

Fig. 16 - Jointed Drive Shaft Grease Fittings

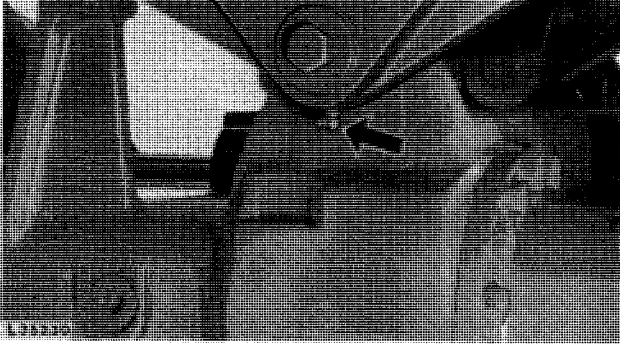

L35230

Fig. 17—Front Axle Carrier Grease Fitting

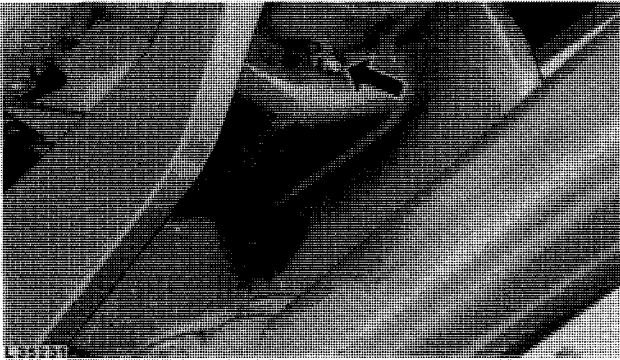

L35231

Fig. 18—Oscillating Support Grease Fitting

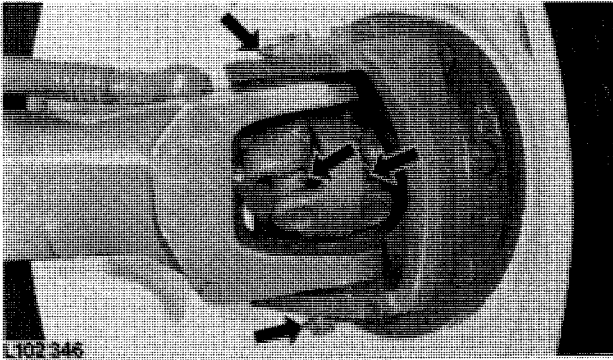

L102346

Fig. 19—Front Axle Grease Fittings

Service Interval: At predelivery and every 50 hours.

LUBRICATING THREE-POINT HITCH

1. Lubricate lift link oiler (1, Figs. 20 and 21) using engine oil.
2. Lubricate lift link grease fittings with several strokes of grease gun, using John Deere EP multipurpose or SAE EP multipurpose grease.

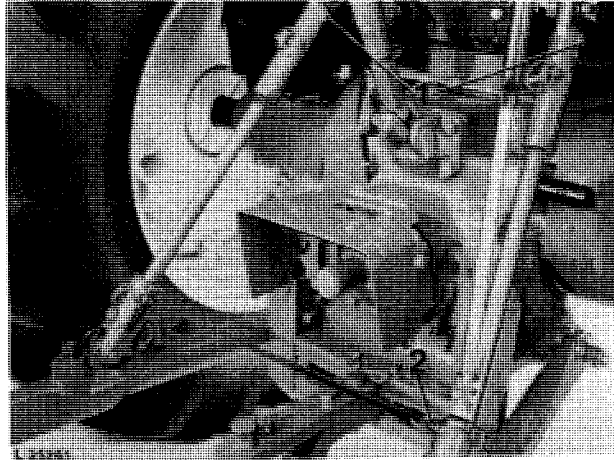

L35261

1—Oiler

2—Grease Fittings

Fig. 20—Lift Link Grease Fittings
(Tractor with SOUND-GARD Body shown)

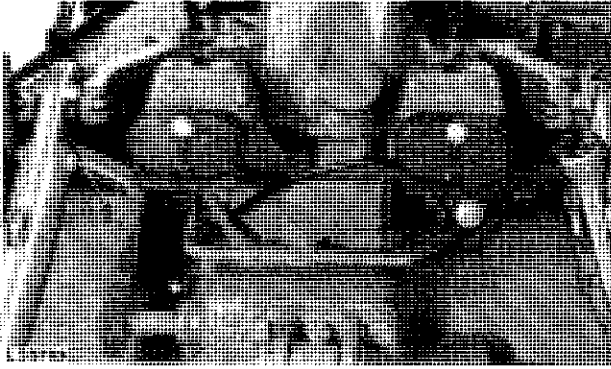

L35199

1—Oiler

2—Grease Fittings

*Fig. 21—Lift Link Grease Fittings
(Tractors without SOUND-GARD Body)*

Service Interval: Lubricate every 200 hours.

LUBRICATING REAR AXLE BEARINGS

Lubricate both bearings with 6 to 8 strokes of grease gun, using John Deere EP multipurpose grease or SAE EP multipurpose grease.

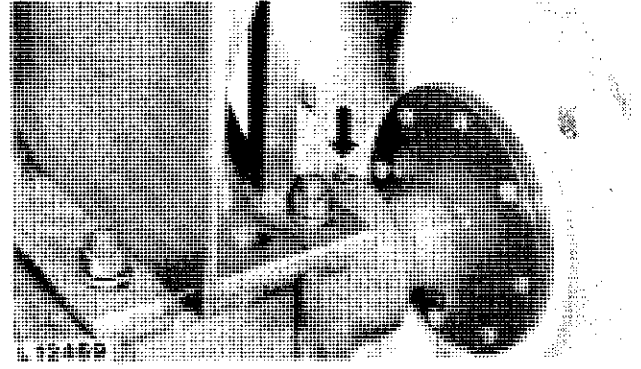

L12469

Fig. 22—Rear Axle Grease Fitting

Service Interval: Every 10 hours (only when operating in extremely wet and muddy conditions) and every 500 hours.

Group 15 TUNE-UP

PRELIMINARY ENGINE TESTING

Before tuning up a tractor, determine whether a tune-up will restore operating efficiency. When there is doubt, the following preliminary tests will help to determine if the engine can be tuned-up. Choose from the following procedures only those necessary to restore the unit.

1. After engine has been stopped for several hours, carefully loosen crankcase drain plug and watch for any water to seep out. A few drops could be due to condensation, but any more would indicate problems which require engine repairs rather than just a tune-up.
2. With engine stopped, inspect engine coolant for an oil film. With engine running, inspect coolant for air bubbles. Either condition would indicate problems which require engine repairs rather than just a tune-up.
3. Perform a dynamometer test and record horsepower. Repeat dynamometer test after tune-up, so horsepower output before and after tune-up can be compared.
4. Perform compression test. (See CTM-4, Engines.)

DYNAMOMETER TEST

If possible, test the engine on a dynamometer before it is tuned. This test gives the horsepower output and fuel consumption of the engine as it is. This will help determine if a tune-up can restore the engine or whether an overhaul is needed.

Good performance by the engine depends on these basic things:

1. An adequate supply of clean air and fuel.
2. Good compression.
3. Proper valve and injection pump timing for good combustion.
4. Proper air and fuel temperatures.

Perform the dynamometer test as follows:

1. Connect the engine to the dynamometer using the manufacturers instructions.
2. Operate the engine at one-half load until the coolant and crankcase oil temperature are up to normal.
3. Run engine at fast idle (2610 to 2660 rpm).
4. Gradually increase the load on the engine until its speed is reduced to 2500 rpm.
5. Read the horsepower on the dynamometer.
6. Compare the reading taken with the following specifications:

PTO horsepower* at 2500 rpm rated engine speed
(PTO speed 565 or 1040 rpm) according
to SAE 816b 63 kW
(85 hp)

**With engine run in (more than 100 hours of operation) and having reached operating temperature (engine and transmission); measured by means of a dynamometer. Permissible variation ± 5 percent.*

TESTING COMPRESSION PRESSURE

NOTE: For testing compression pressure see CTM-4, Engines.

ENGINE TUNE-UP

Air Intake System

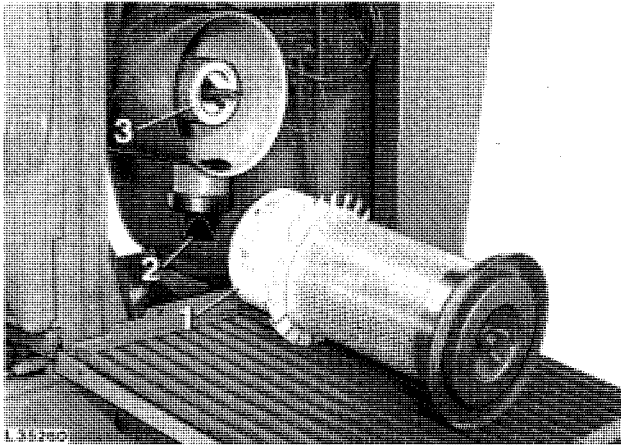

L23500

Fig. 1—Air Cleaner and Safety Element

Dusty Element

1. Check air cleaner element (1, Fig. 1) if dirty, tap it on the palm of your hand.
2. If tapping element does not remove dust, blow out dust with compressed air. Pressure not to exceed 600 kPa (6 bar; 85 psi) by inserting nozzle inside of element and blowing from the inside of the filter to the outside.

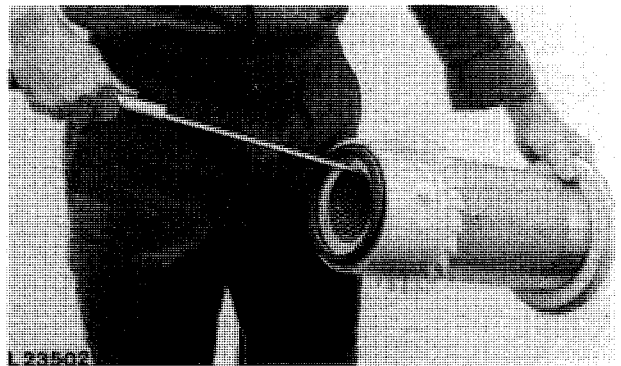

L23502

Fig. 2—Cleaning Air Cleaner Element by Means of Compressed Air

Oily or Sooty Element

IMPORTANT: Never wash element in fuel oil, gasoline or strong cleaning agent. Never use compressed air to dry element.

1. Wash element in a solution of lukewarm water and non-foaming cleaning agent. Rinse element thoroughly from the inside with clean water (water pressure not above 300 kPa; 3 bar; 43 psi). Shake water from element and dry for approximately 24 hours at a temperature of 20°C (70°F).

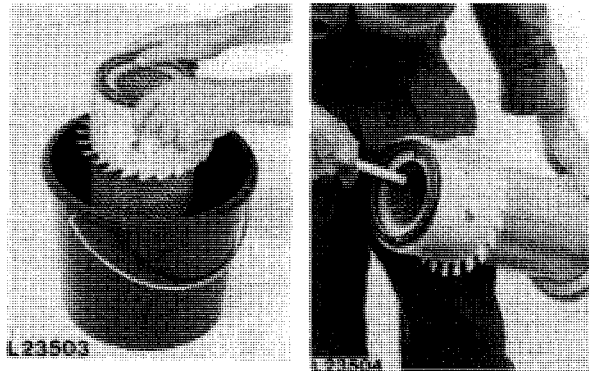

L23503

L23504

Fig. 3—Wet Cleaning

2. After cleaning the element, inspect it by placing a bright light inside the filter. Discard any filter that shows the slightest rupture, indicated by light through the hole. Make sure gasket is in a serviceable condition.

IMPORTANT: Replace filter element after six cleanings or one year of service, whichever occurs first.

3. When servicing the air cleaner always removed and clean the rubber dust unloading valve.
4. The valve must always be installed with slot facing direction of travel.

IMPORTANT: Do not operate engine without air cleaner element or rubber dust unloading valve installed.

Air Cleaner Secondary (Safety) Element

1. This filter element must be changed annually, when clogged or damaged and with every third service of air cleaner primary element.
2. Should it become necessary to clean primary filter element more often than usual, this is a sign that the secondary (safety) filter must be replaced.

IMPORTANT: Always replace secondary (safety) filter element, do not attempt to clean.

Air Intake Connections

Check all connections in air intake system for possible leaks. Tighten any loose clamps. Be sure rubber dust unloading valve is in good condition.

Measuring Air Intake System Vacuum

Check for restrictions in air intake system by measuring vacuum.

1. Clean air cleaner.
2. Remove left-hand radiator grille screen.
3. Run engine until it has reached normal operating temperature.
4. Remove plug or burner (when equipped with Thermostart cold weather starting aid) or starting fluid line at intake manifold (when equipped).
5. Install and tighten connector JTO5495* (sub. for 0753) in bore now free.
6. Using connector FKM 10302* pressure hose FKM 10209* and connector FKM 10303* attach vacuum gauge FKM 10242 to connector JTO5495* (sub. for 0753).

* Part of testing kit FKM 10002 SERVICE-GARD Version of vacuum test kit is D-05022 ST.

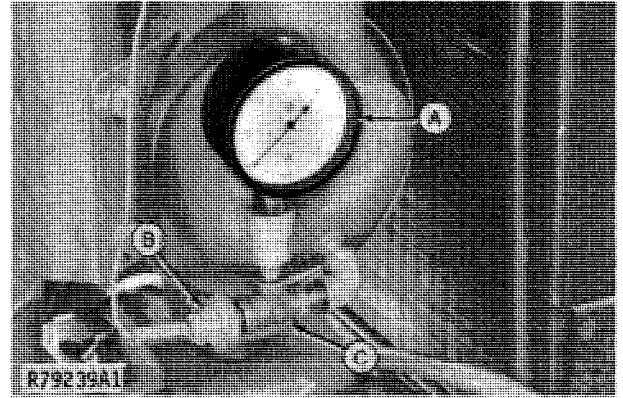

R79239A1

A—Gauge
B—Switch

C—T-Fitting

Fig. 4—Measuring Air Intake System Vacuum

7. Run engine at 2610 to 2660 rpm.
8. With a clean element installed, vacuum should be approx. 3.5 kPa (35 mbar; 14 in. water head), but never exceed 6 kPa (60 mbar; 25 in. water head). If this is the case, there is a restriction in the air intake system. Determine and remedy the cause.
9. At the same time check air cleaner restriction warning switch.
10. Run engine at 2500 rpm. Use a piece of cardboard to partially cover air cleaner intake. Increase the restriction until air cleaner indicator light goes on, and note vacuum reading.
11. Air cleaner restriction warning switch should close at a vacuum of 5.5 to 6.5 kPa (55 to 65 mbar; 22 to 26 in. water head). If not, replace switch.

Exhaust System

Inspect exhaust system for any leaks or restrictions. Correct as necessary.

Measuring Blow-By

NOTE: Measuring blow by (See CTM-4, Engines).

Crankcase Vent Tube



L23946

Fig. 5—Crankcase Vent Tube

1. Inspect crankcase vent tube for restriction. Lack of ventilation causes sludge to form in engine crankcase. This can lead to clogging of oil passages and filter, resulting in serious engine damage.
2. If necessary, clean vent tube in solvent.

Cooling System

Cleaning Radiator

1. Clean radiator grille screens, if necessary.

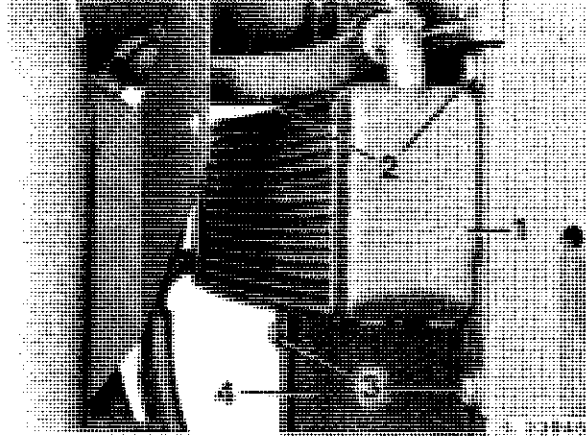

L23946

- | | |
|--------------|--------------|
| 1—Oil Cooler | 3—Cap Screws |
| 2—Cap Screws | 4—Radiator |

Fig. 6—Radiator and Oil Cooler

2. Clean radiator and oil cooler. To clean portion of radiator behind oil cooler, remove cap screws (2 and 3, Fig. 6).

Flushing Cooling System

1. Drain cooling system by opening drain cocks on radiator and engine block.
2. turn on cab heating (if equipped) and keep in operating position until cleaning is completed.
3. Close drain cocks and fill cooling system with clean water.
4. Run engine until it reaches operating temperature to stir up possible rust or sediment.



L20947

Fig. 7—Cooling System Drain Cocks

5. Stop engine and drain coolant before rust or sediment settles.
6. Close drain cocks and fill cooling system with a solution of John Deere cooling system cleaner or its equivalent and water. Follow the instructions with the cleaner.
7. After cleaning, flush the system with clean water.
8. Fill cooling system with clean, soft water and antifreeze. use a permanent-type, ethylene glycol antifreeze which contains a rust inhibitor but does not contain a stop-leak additive.
9. Recheck coolant level after starting engine. Coolant level should be midway between the filler neck and top of radiator core.
10. Cooling system capacity:

without SOUND-GARD Body	17 L
	4.50 U.S. gal.
with SOUND-GARD Body	19 L
	5.00 U.S. gal.

Checking Radiator for Leaks

1. Remove radiator.
2. Install radiator cap and plug top connection.
3. Attach compressed air hose to bottom connection.
4. Submerge radiator in clean tank filled with clear water.
5. Apply 50 kPa (0.5 bar; 7 psi) pressure to radiator and check whether this pressure is maintained. If not, correct the problem.

NOTE: Radiator repairs should only be made in specialised repair shops.

Radiator Cap

1. Check radiator cap, rubber seal and spring for serviceability. The seal must fit tightly and feels soft.
2. Using a commercially available special tester, check whether high pressure valve can hold a pressure of 40—50 kPa (0.4—0.5 bar; 6—7 psi) or opens at a higher pressure.
3. Low pressure valve should open at 0—4 kPa (0.04 bar; 0.6 psi). Replace radiator cap, if necessary.

Checking Thermostats

NOTE: Checking thermostats, See CTM-4, Engines.

Fuel System

1. Clean fuel transfer pump strainer.

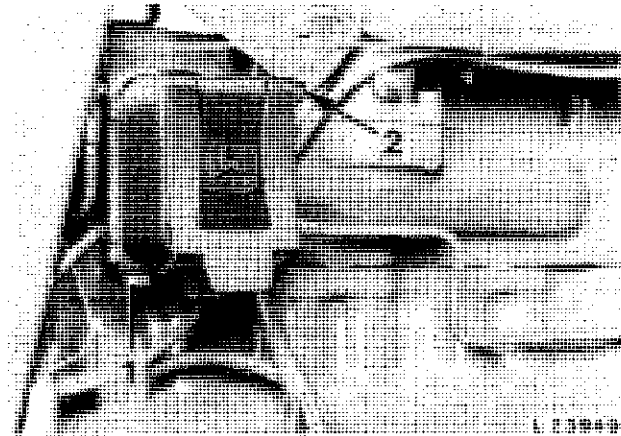

L23949

1—Drain Plug

2—Bleed Screw

Fig. 8—Fuel Filter Installed

2. Check fuel filter for water or sediment. If any is present, remove drain plug (1, Fig. 8) and drain it out. Caution customer about importance of proper fuel storage.

NOTE: Fuel filters must be replaced periodically to prevent excessive restriction. During a tune-up is a good time to perform this service.

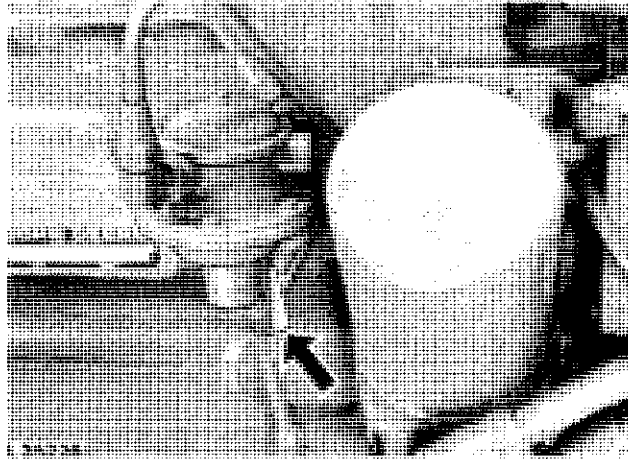

L35226

Fig. 9—Fuel Transfer Pump Primer Lever

3. After draining fuel filter, bleed fuel system. Loosen bleed screw (2, Fig. 8) and work primer lever (Fig. 9) until fuel flow free of air bubbles. Tighten bleed screw.

NOTE: If the primer lever will not pump fuel and no resistance is felt at upper end of stroke, turn engine with starter to change position of fuel pump drive lobe on camshaft. When bleeding is completed, be sure to leave primer lever at lowest point of stroke.

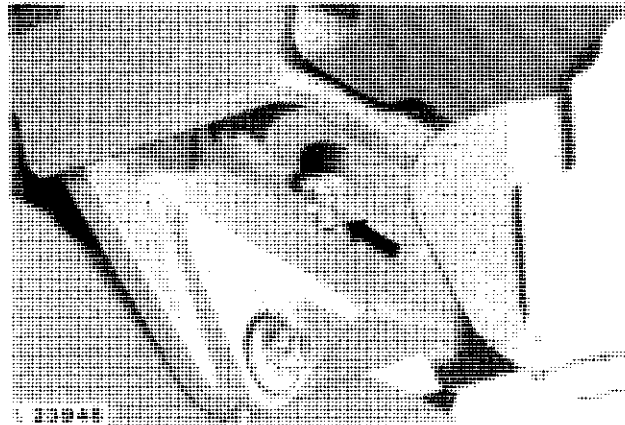

L23948

Fig. 10—Fuel Tank Drain Tap

4. Open fuel tank drain tap and drain any water or sediment deposits.
5. Check entire fuel system for leaks. Correct as necessary.
6. Check injection pump timing (See CTM-4, Engines). Time injection pump, if necessary.

7. Check idle speeds
 Slow idle 700 to 800 rpm
 Fast idle 2610 to 2660 rpm
8. Adjust speed control linkage, if necessary (see Section 30, Group 20).

Electrical System

1. Clean batteries, cables, and compartments with a clean cloth. If corrosion is present, remove it with a wire brush.
2. Coat battery terminals and connectors with petroleum jelly to retard corrosion.
3. Test batteries as instructed in Section 40, Group 05. If batteries are not near full charge, try to find out why.
4. Check level of electrolyte in each battery cell. Level should be to bottom of filler neck. Use distilled water to fill cell.

If water must be added to batteries more often than every 200 hours, alternator may be overcharging. Refer to Section 40, Group 35.

5. If batteries appear to be either undercharged or overcharged check alternator and charging circuit (see Section 40, Group 35).
6. Check tension of fan belt and compressor belt (if equipped) and adjust, if necessary.
7. The fan belt should have 19 mm (3/4 in.) flex with 90 N (20 lb) pull midway between crankshaft and alternator or water pump.
8. Compressor belt (if equipped) should deflect 19 mm (3/4 in.) when a 60 N (13 lb) force is applied midway between pulleys.
9. Check lighting system for proper operation. In case of a malfunction, refer to Section 40, Group 20.

10. Check operation of start safety switch. Starter should only operate when main switch key is in position "1" and range shift lever in neutral position.

11. Start engine and check operation of starting motor, gauges and indicator lights.

Final Engine Test

Repeat dynamometer test. Compare performance with test carried out before tune-up.

PTO horsepower* at 2500 rpm rated engine speed
 (PTO speed 565 or 1040 rpm) according
 to SAE 816b 63 kW
 (85 hp)

CHECKING TRACTOR OPERATION

Check the following as outlined in Group 05 of this Section (starting from page 11).

1. Power Train
2. Steering and Brakes
3. Hydraulic System
4. Miscellaneous
5. SOUND-GARD Body





In case of a malfunction refer to relevant group in this technical manual.

Torques

Tighten all accessible cap screws and nuts (see charts on following pages).

* With engine run in (more than 100 hours of operation) and having reached operating temperature (engine and transmission). Permissible variation ± 5 percent.

STANDARD TORQUES

RECOMMENDED TORQUES IN N:m, AND FT-LBS FOR UNC AND UNF CAP SCREWS				
Head Marking (identifying strength)	  or 10.9*		  or 12.9**	
Thread-O.D. (in.)	N:m	ft-lbs	N:m	ft-lbs
1/4	15	10	20	15
5/16	30	20	40	30
3/8	50	35	70	50
7/16	80	55	110	80
1/2	120	85	170	120
9/16	180	130	240	175
5/8	230	170	320	240
3/4	400	300	580	425
7/8	600	445	930	685
1	910	670	1400	1030
1-1/8	1240	910	1980	1460
1-1/4	1700	1250	2800	2060

RW7097

NOTE: A variation of $\pm 10\%$ is permissible for all torques indicated in this chart.

Torques figures indicated above and in the Specifications sections of this manual are valid for non-greased or non-oiled threads and heads unless otherwise specified. Therefore, do not grease or oil bolts or cap screws unless otherwise specified in this manual.

* Tempered steel high-strength bolts and cap screws

** Tempered steel extra high-strength bolts and cap screws

RECOMMENDED TORQUES IN N:m, AND FT-LBS FOR METRIC CAP SCREWS						
Head Marking (identifying strength)	8.8*		10.9**		12.9***	
	N:m	ft-lbs	N:m	ft-lbs	N:m	ft-lbs
M5	7	5	9	6.5	10	8.5
M6	10	8.5	15	10	20	15
M8	30	20	40	30	40	30
M10	50	35	80	60	90	70
M12	100	75	140	100	160	120
M14	160	120	210	155	260	190
M16	240	175	350	260	400	300
M20	480	355	650	480	780	575
M24	820	605	1150	850	1350	995
M30	1640	1210	2250	1660	2700	1990
M36	2850	2110	4000	2950	4700	3465

RW7095

NOTE: A variation of $\pm 10\%$ is permissible for all toques indicated in this chart.

Torques figures indicated above and in the Specifications sections of this manual are valid for non-greased or non-oiled threads and heads unless otherwise specified. Therefore, do not grease or oil bolts or cap screws unless otherwise specified in this manual.

- * Regular bolts and cap screws
- * Tempered steel high-strength bolts and cap screws
- ** Tempered steel extra high-strength bolts and cap screws

RECOMMENDED TORQUES IN N:m, AND FT-LBS FOR PIPE AND HOSE CONNECTIONS				
Thread size	with O-rings		with Cone	
	N:m	ft-lbs	N:m	ft-lbs
3/8-24 UNF	7.5	5.5	8	6
7/16-20 UNF	10	7	12	9
1/2-20 UNF	12	9	15	11
9/16-18 UNF	15	11	25	18
3/4-16 UNF	25	20	45	35
7/8-14 UNF	40	30	60	45
1-1/16-12 UNC	60	45	100	75
1-3/16-12 UNC	70	50	120	90
1-5/16-12 UNC	80	60	140	105
1-5/8-12 UNC	110	80	190	140
1-7/8-12 UNC	150	110	220	160

RW7096



Suggest:

If the above button click is invalid.

Please download this document

first, and then click the above link

to download the complete manual.

Thank you so much for reading

Group 20 TRACTOR SEPARATION

SEPARATING BETWEEN ENGINE AND TRACTOR FRONT END

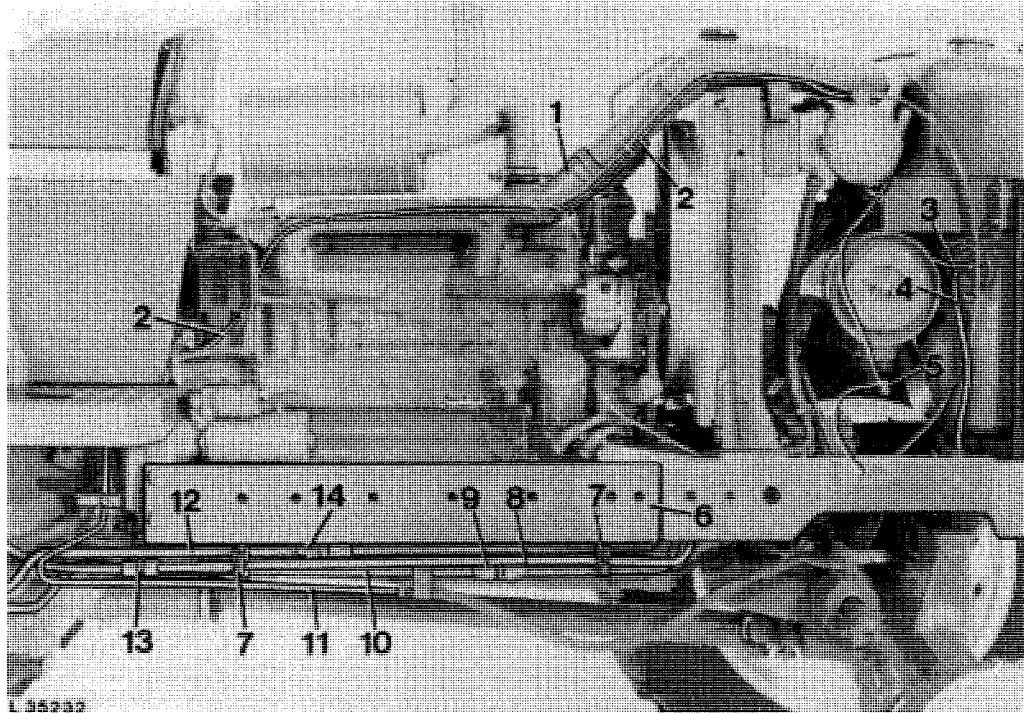

- | | | | |
|------------------------------------|--------------------------------|---------------------------------------|---------------|
| 1—Air Intake Line | 4—Fuel Inlet Line | 9—Connection | 13—Connection |
| 2—Leak-Off and Vent Line | 5—Connector | 10—Oil Cooler Return Line | 14—Connection |
| 3—Cable of Fuel Gauge Sending Unit | 6—Side Frame | 11—Hydrostatic Steering Pressure Line | |
| | 7—Spacer Clamps | 12—Hydraulic Pump Inlet Line | |
| | 8—Hydraulic Pump Pressure Line | | |

Fig. 1 - Separating Between Tractor Front End and Engine Right-Hand Side

⚠ CAUTION: Do not lubricate or adjust tractor while engine is running unless recommended.

When servicing mechanical front-wheel drive equipped tractor with rear wheels supported off ground and engine running, always support front wheels in a similar manner. Loss of electrical power or transmission-hydraulic system pressure will engage front driving wheels, pulling rear wheels off support if front wheels are not raised.

Under these conditions, note that the front drive wheels can engage even with switch in disengaged position.

IMPORTANT: After having serviced, cleaned or repaired you tractor, always reinstall any safety guards or shields removed before operating.

<https://www.ebooklibonline.com>

Hello dear friend!

Thank you very much for reading.

Enter the link into your browser.

The full manual is available for immediate download.

<https://www.ebooklibonline.com>