

JOHN DEERE
WORLDWIDE COMMERCIAL & CONSUMER
EQUIPMENT DIVISION

Sabre Garden Tractors
2048HV, 2254HV, and 2554HV

OPERATOR'S MANUAL



OMM140479 I9

North American Version
Litho in U.S.A.

INTRODUCTION

Thank You for Purchasing a John Deere Product

We appreciate your business and wish you many years of safe and satisfied use of your machine.

Using Your Operator's Manual

This manual is an important part of your machine and should remain with the machine when you sell it.

Reading your operator's manual will help you and others avoid personal injury or damage to the machine. Information given in this manual will provide the operator with the safest and most effective use of the machine. Knowing how to operate this machine safely and correctly will allow you to train others who may operate this machine.

Section in your operator's manual are placed in a specific order to help you understand all the safety messages and learn the controls so you can operate this machine safely. You can also use this manual to answer any specific operating or servicing questions. A convenient index located at the end of this book will help you to find needed information quickly.

The machine shown in this manual may differ slightly from your machine, but will be similar enough to help you understand our instructions.

RIGHT-HAND and LEFT-HAND sides are determined by facing in the direction the machine will travel when going forward. When you see a broken line arrow (----->), the item referred to is hidden from view.

Special Messages

Your manual contains special messages to bring attention to potential safety concerns, machine damage as well as helpful operating and servicing information. Please read all the highlighted information carefully to avoid injury and machine damage.

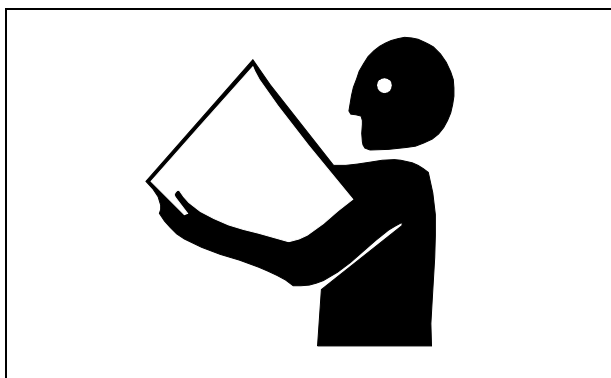

CAUTION: Avoid injury!

This symbol and text highlight potential hazards or death to the operator or bystanders may occur if the hazards or procedures are ignored.

IMPORTANT: Avoid machine damage! This text is used to tell the operator of actions or conditions that might result in damage to the machine.

NOTE: General information is given throughout the manual that may help the operator in the operation of the machine.

CALIFORNIA Proposition 65 Warning



WARNING: The Engine Exhaust from this product contains chemicals known to the State of California to cause cancer, birth defects or other reproductive harm.

PRODUCT IDENTIFICATION

Record Identification Numbers

Sabre Garden Tractors

2048HV, 2254HV & 2554HV PIN No. (020001 -)

If you need to contact an Authorized Service Center for information on servicing, always provide the product model and serial number.

You will need to locate the identification number for the machine and for the engine. Record the information in the spaces provided below.

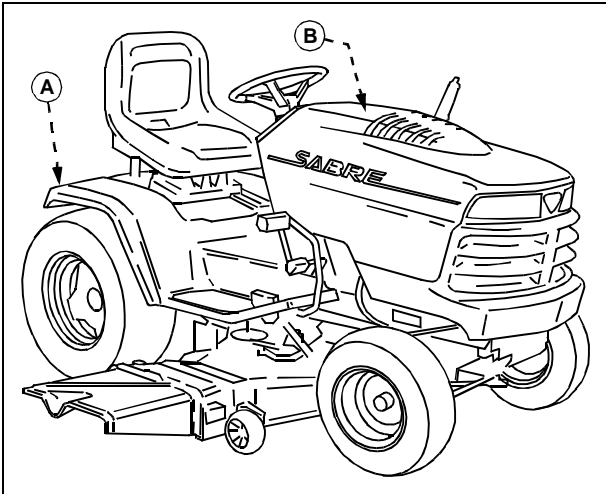

DATE OF PURCHASE:

DEALER NAME:

DEALER PHONE:

PRODUCT IDENTIFICATION NUMBER (A):

ENGINE SERIAL NUMBER (B):

<https://www.ebooklibonline.com>

Hello dear friend!

Thank you very much for reading.

Enter the link into your browser.

The full manual is available for immediate download.

<https://www.ebooklibonline.com>

TABLE OF CONTENTS

Contents

Safety Signs	1
Operating	7
Replacement Parts	19
Service Interval Chart	21
Service Lubrication	23
Service Engine	24
Service Transmission	28
Service Mower	29
Service Electrical	33
Service Miscellaneous	37
Troubleshooting	41
Storing Machine	45
Assembly	47
Specifications	52
Warranty	55
Index	58
Sabre by John Deere Quality Statement	63
Service Record	64

All information, illustrations and specifications in this manual are based on the latest information at the time of publication. The right is reserved to make changes at any time without notice.

COPYRIGHT© 1999
Deere & Co.
John Deere Worldwide Commercial and
Consumer Equipment Division
Horicon, WI
All rights reserved
Previous Editions
COPYRIGHT© 1998 and 1997

English

SAFETY

Understanding The Machine Safety Labels

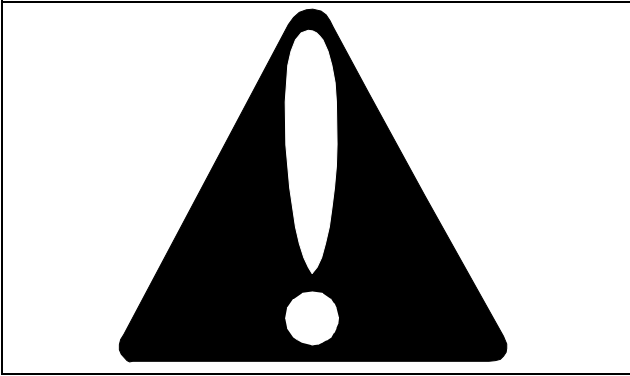

The machine safety labels shown in this section are placed in important areas on your machine to draw attention to potential safety hazards.

On your machine safety labels, the words DANGER, WARNING, and CAUTION are used with this safety-alert symbol, (▲). DANGER identifies the most serious hazards.

The operator's manual also explains any potential safety hazards whenever necessary in special safety messages that are identified with the word, CAUTION, and the safety-alert symbol, (▲).

DANGER: ROTATING BLADES CUT OFF ARMS AND LEGS



- Do not mow when children or others are around
- Do not mow in reverse
- Look down and behind before and while backing
- Never carry children

WARNING: AVOID SERIOUS INJURY OR DEATH

- Drive up and down slopes, not across
- Avoid sudden turns
- If machine stops going uphill, stop blade and back down slowly
- Keep safety devices (guards, shields, and switches) in place and working
- Read operator's manual
- When leaving machine:
 - Stop engine
 - Set park brake
 - Remove key

WARNING: LOADED SPRING

Lock lift lever forward before changing attachments.



Picture Note: One decal on each side of tractor frame

SAFETY

DANGER/POISON

Shield eyes.



Picture Note: Located on Battery

Explosive gases can cause blindness or injury.

NO

- Sparks
- Flames
- Smoking

Sulfuric acid can cause blindness or severe burns

Flush eyes immediately with water.

Get medical help fast.

Maintenance-free

Keep out of the reach of children. Do not tip. Do not open battery!

DANGER: ROTATING BLADE



Do not put hands or feet under or into mower when engine is running.

THROWN OBJECTS

Before mowing, clear area of objects that may be thrown by blade.

Do not operate mower without discharge chute or entire grass catcher in place.

DANGER

ROTATING BLADE



Picture Note: Located on Left-Hand side of deck

Do not put hands or feet under or into mower when engine is running.

Certification Label

This OPEI label on your mower indicates that this model has been certified by an independent laboratory for compliance with American National Standard B-71.1-1996, "Safety Specifications" for Power Lawn Mowers, Lawn and Garden Tractors, and Lawn Tractors.

SAFETY

Operate Safely

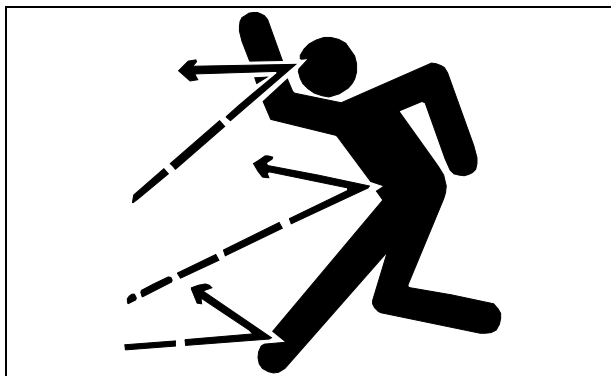

- In addition to reading your Operator's Manual, view your John Deere Mowing Safety Video.
- Check brake action before you operate. Adjust or service brakes as necessary.
- Inspect machine before you operate. Be sure hardware is tight. Repair or replace damaged, badly worn, or missing parts. Be sure guards and shields are in good condition and fastened in place. Make any necessary adjustments before you operate.
- Clear work area of objects that might be thrown. Keep people and pets out of the work area. Stop machine if anyone enters the area.
- If you hit an object, stop the machine and inspect it. Make repairs before you operate. Keep machine and attachments properly maintained and in good working order.
- DO NOT leave machine unattended when it is running.
- Only operate during daylight or with good artificial light.
- Be careful of traffic when operating near or crossing roadways.
- Do not wear radio or music headphones while operating the machine. Safe operation requires your full attention.
- Older adults are involved in a large percentage of riding mower accidents involving injury. These operators should evaluate their ability to operate a mower safely enough to protect the operator and others from serious injury.

Park Safely

- Stop machine on a level surface, not on a slope.
- Disengage mower blades.
- Lower attachments to the ground.
- Engage park brake.
- STOP engine.
- Remove key.

- Before you leave the operator's seat, wait for engine and all moving parts to STOP.

Rotating Blades are Dangerous - Protect Children and Prevent Accidents

PROTECT CHILDREN:

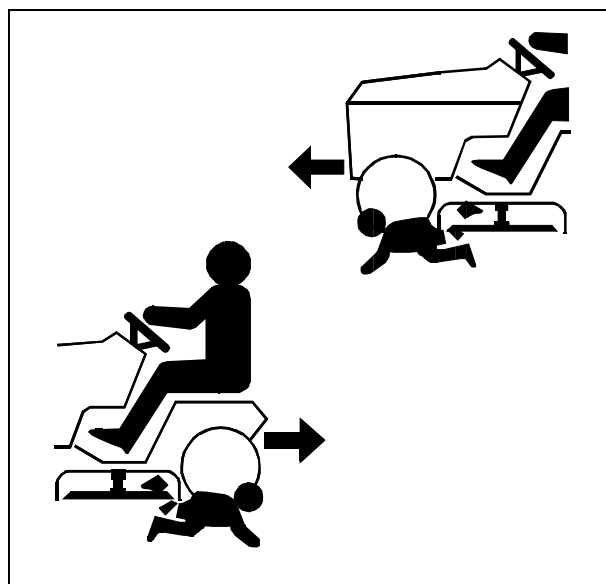

- Never assume that children will remain where you last saw them. Children are attracted to mowing activity, stay alert to the presence of children.
- Keep children in the house when you are operating the machine.
- Turn machine off if a child enters the mowing area.
- Use extra care when you come to blind corners, shrubs, trees, or other objects that may block your vision.
- DO NOT let children or an untrained person operate the machine.
- DO NOT carry or let children ride on machine or any attachment. DO NOT tow children in a cart or trailer.

HELP PREVENT SERIOUS OR FATAL ACCIDENTS:

- Be alert at all times, drive forward carefully. People especially children can move quickly into the mowing area before you know it.
- Back carefully. Disengage mower blades and look behind the machine carefully, especially for children, before you back up.
- DO NOT mow in reverse unless it is absolutely necessary.
- Disengage mower blades when you are not mowing.
- DO NOT operate machine if you are under the influence

SAFETY

of drugs or alcohol.

Avoid Tipping

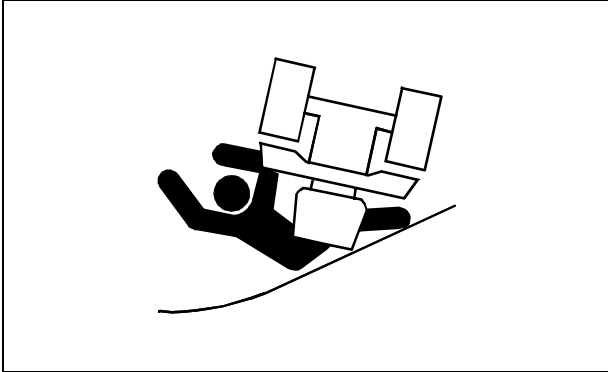

- DO NOT drive where machine could slip or tip.
- Stay alert for holes and other hidden hazards in the terrain.
- Keep away from drop-offs.
- Slow down before you make a sharp turn or operate on a slope.
- When pulling loads or using heavy equipment, use only approved hitches, limit loads to those you can safely control, and use counterweights or wheel weights when required per this manual or your attachment manual.
- Drive up and down a hill—not across. Be careful when you change direction on a slope.
- DO NOT stop when going up hill or down hill. If machine stops going up hill, DISENGAGE mower blades and back down slowly.
- DO NOT mow wet grass. Reduced traction could cause sliding.
- DO NOT try to stabilize the machine by putting your foot on the ground.

Keep Riders Off



- Only allow the operator on the machine. Keep riders off.
- Riders on the machine or attachment may be struck by foreign objects or thrown off the machine causing serious injury.
- Riders obstruct the operator's view resulting in the machine being operated in an unsafe manner.

Stay Clear of Rotating Drivelines

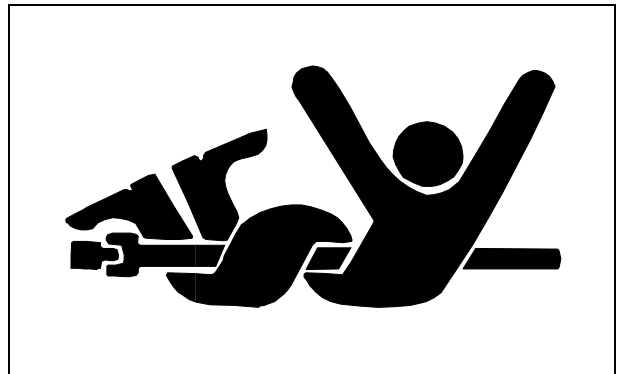

Entanglement in rotating driveline can cause serious injury or death:

- Wear close fitting clothing.
- STOP the engine and be sure PTO driveline is stopped before getting near it.

SAFETY

Transport Safely

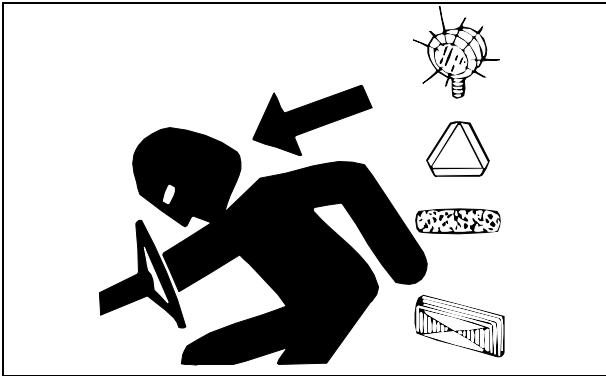

- Use safety lights and devices. Slow moving machines when driven on public roads are hard to see, especially at night. Avoid personal injury or death resulting from a collision with a vehicle.
- Whenever driving on public roads, use flashing warning lights and turn signals according to local regulations. Extra flashing warning lights may need to be installed.

Operating Mower Safely

- In addition to reading your Operator's Manual, view your John Deere Mowing Safety Video.

Check Ground Conditions

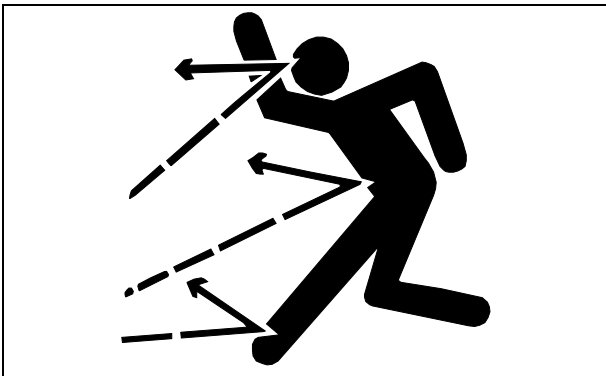

- Clear mowing area of objects that might be thrown. Keep people and pets out of mowing area.
- Study mowing area. Set up safe mowing pattern. Do not mow under conditions where traction or stability is doubtful.
- First, test drive area with PTO switch DISENGAGED and mower lowered. Slow down when you travel over rough ground.

Avoid Injury From Contacting Blades

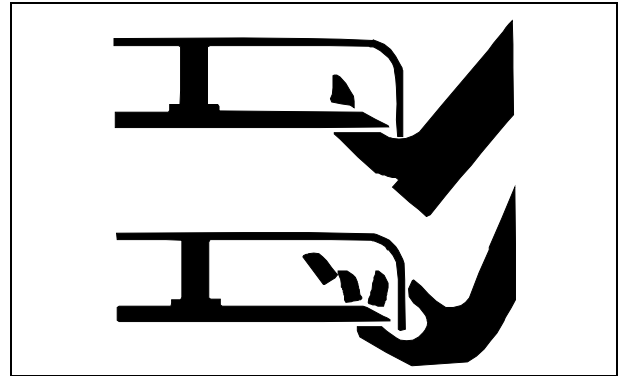

Before you dismount to unplug or adjust mower:

- DISENGAGE PTO switch to stop mower blades.
- STOP the engine.
- LOCK the park brake.
- Remove key.
- Wait for mower blades to STOP.
- Keep hands, feet and clothing away from mower deck when engine is running.
- DISENGAGE PTO switch to stop mower blades when you are not using mower.

Practice Safe Maintenance



- Understand service procedure before doing work. Keep area clean and dry.
- Never lubricate, service, or adjust machine while it is moving. Keep safety devices in place and in working condition. Keep hardware tight.
- To prevent them from getting caught, keep hands, feet, clothing, jewelry, and long hair away from any moving parts.
- Before servicing machine, disengage all power and stop the engine. Let engine cool.
- Securely support any machine elements that must be

SAFETY

raised for service work.

- Keep all parts in good condition and properly installed. Fix damage immediately. Replace worn or broken parts. Remove any buildup of grease, oil, or debris.
- Unauthorized modifications to the machine may impair its function and safety.

Wear Appropriate Clothing

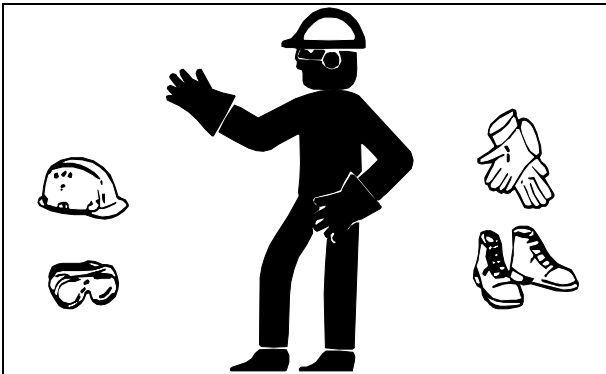

- Wear close fitting clothing and safety equipment appropriate for the job.
- Loud noise can cause impairment or loss of hearing, wear a suitable protective device such as earplugs.
- Do not wear radio or music headphones while servicing the machine. Safe service requires your full attention.

Avoid Injury From Contacting Blades

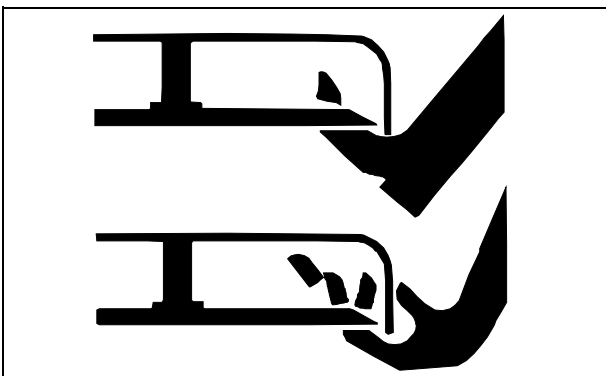

Before you unplug or adjust machine:

- STOP the engine.
- Remove key.
- Wait for blades to STOP.
- Keep hands, feet and clothing away from blades when engine is running.

Handling Waste Product and Chemicals

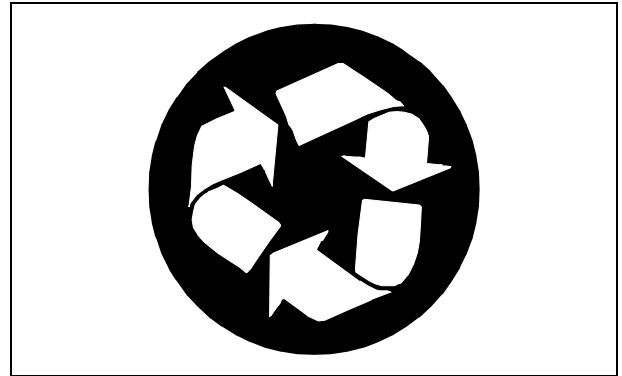

- Waste products such as used oil, fuel, coolant, brake fluid, and batteries, can harm the environment and people.
- DO NOT use beverage containers for waste fluids - someone may drink from them.
- See your local Recycling Center or John Deere dealer to learn how to recycle or get rid of waste products.
- A Material Safety Data Sheet (MSDS) provides specific details on chemical products: physical and health hazards, safety procedures, and emergency response techniques. See your John Deere dealer for the MSDS on chemical products used with your machine.

OPERATING

Daily Operating Checklist

- Test safety systems.
- Check tire pressure.
- Check fuel level.
- Check engine oil level.
- Remove grass and debris from machine.

Controls

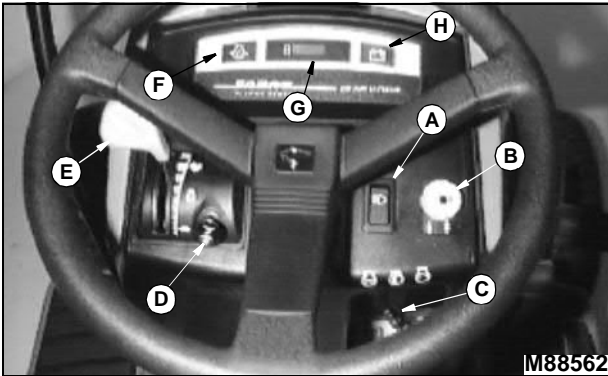

- A - Light Switch
- B - PTO Switch/RIO Switch
- C - Key Switch
- D - Choke Knob
- E - Throttle Lever
- F - Engine Oil Pressure Light
- G - Hour Meter
- H - Battery Discharge Light
- I - Cut Height Adjustment Lever
- J - Park Brake Lever
- K - Brake Pedal
- L - Forward Travel Pedal
- M - Reverse Travel Pedal
- N - Mower Deck Lift Lever

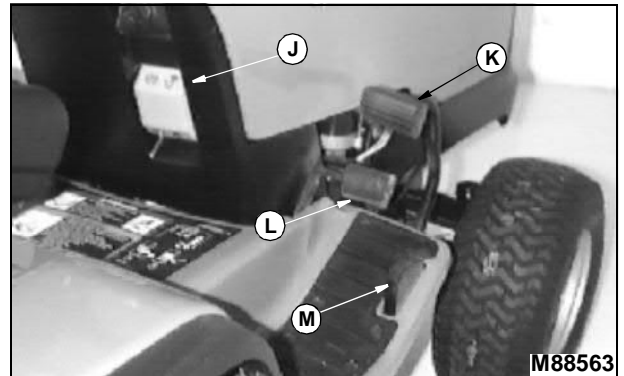
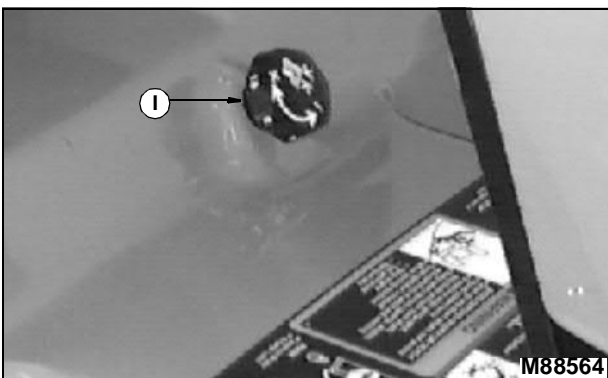

Adjusting Seat

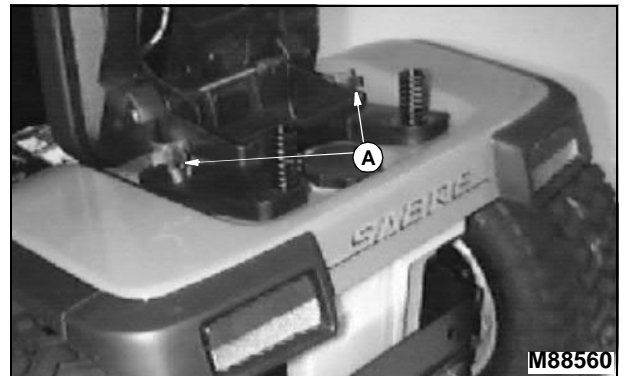

1. Tip seat forward and loosen two knobs (A) to slide seat assembly forward or rearward to most comfortable OPERATOR position.
2. Tighten knobs after adjustment to keep seat in place.

OPERATING

Adjusting Cutting Height

IMPORTANT: Avoid machine damage, lift lever must be in TRANSPORT (upper) position before turning cutting height knob.

NOTE: Adjust mower deck gage wheels after you change cutting height. (See Adjusting Mower Gage Wheels in this section.)

Cutting height can be adjusted from approximately 25–100 mm (1–4 in).

When lift lever is in TRANSPORT (upper) position (lift lever all the way back), cutting height is approximately 100 mm (4 in).

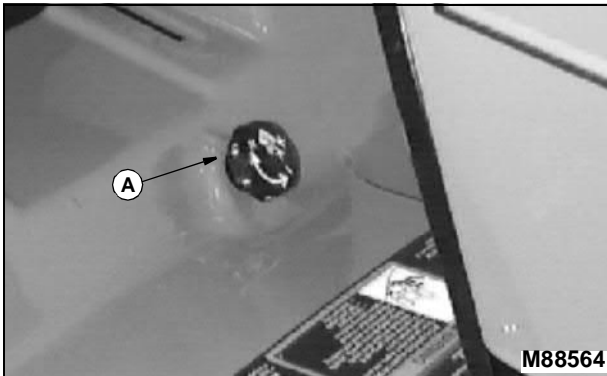

Knob (A) has cutting height identification numbers embossed in it. To change or attain cutting height desired:

- Pull lift lever all the way back to TRANSPORT (upper) position.
- Turn cutting height knob (A) to desired cutting height position. Mower will be at this cutting height each time you lower it.

Adjusting Mower Gage Wheels

CAUTION: Avoid injury, before you adjust gage wheels:
STOP engine.
Remove key.
Wait for blades to STOP.

IMPORTANT: Avoid machine damage, mower gage wheels must not ride on ground to support mower weight. Adjust gage wheels each time you change cutting height.

1. Check tractor tire pressure. Inflate tires to the correct pressure. (See Checking Tire Pressure in Service - Miscellaneous section.)
2. Raise mower lift lever to TRANSPORT (upper) position and adjust cutting height. (See Adjusting Cutting Height in this section.)

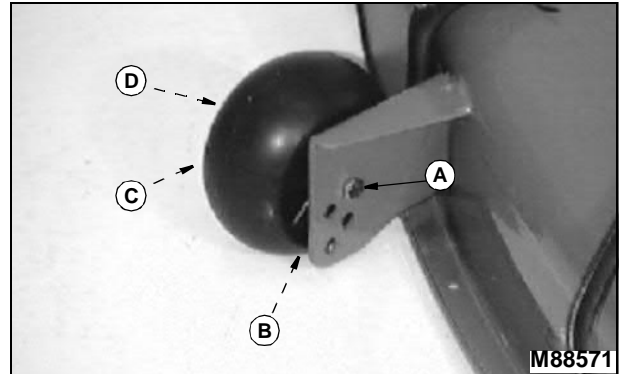

3. Remove bolt (A), bushing (B), washer (C), and tighten with nut (D).
4. Move mower gage wheels, one on each side, to one of four holes for desired position.
5. Install bolt and tighten with nut.
6. Move lift lever forward to MOWING (lower) position.
7. Bottom of gage wheels should be approximately 6-13 mm (1/4-1/2 in) from the ground when properly adjusted.

Adjusting Mower Level (Side-to-Side)

CAUTION: Avoid injury, before you adjust mower:
STOP engine.
Remove key.
Wait for blades to STOP.
Be careful of sharp edges on mower blades. Always wear gloves when handling mower blades.

NOTE: A deck leveling gauge (Part Number TY15272) to aid in deck leveling may be obtained through your local SABRE Service Center at a nominal cost.

1. Park tractor on a hard, level surface.
2. Stop engine and remove key.

OPERATING

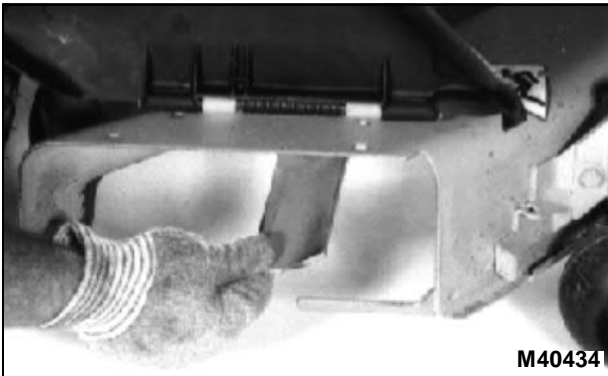

3. CHECK: Tire pressures must be correct. (See Checking Tire Pressure in Service – Miscellaneous section.)
4. Adjust cutting height to 50 mm (2 in). (See Adjusting Cutting Height in this section.)

NOTE: Mower gage wheels should not contact the ground.

5. Put mower lift lever in MOWING (lower) position.
6. Turn left blade by hand parallel to tractor axle. Hold drive belt and turn right blade parallel to axle.

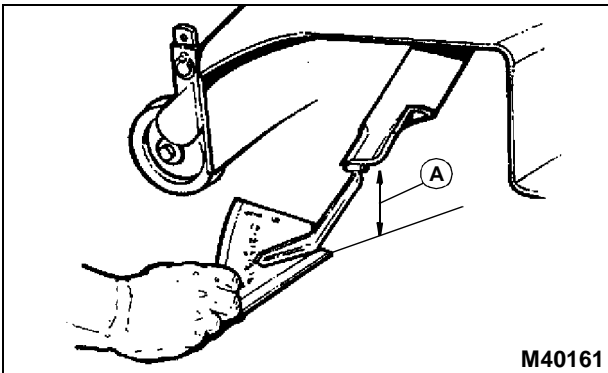

7. Measure from each outside blade tip (A) to the level surface. The difference between measurements must not be more than 3 mm (1/8 in).

NOTE: Adjustable lift links are on both sides of mower. Cutting height can closely match knob setting by using adjustment on both sides. DO NOT adjust deck too high or it will not lock in transport (upper) position.

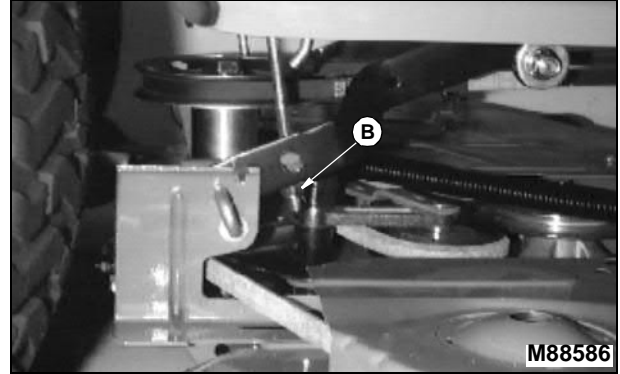

8. Turn nut (B), (right side shown): Clockwise to RAISE right side of mower and counterclockwise to LOWER right side of mower.
9. Check side-to-side measurements and readjust if necessary.

Adjusting Mower Level (Front-to-Rear)



CAUTION: Avoid injury, before you adjust mower:

STOP engine.

Remove key.

Wait for blades to **STOP**.

Be careful of sharp edges on mower blades. **Always wear** gloves when handling mower blades.

NOTE: Mower gage wheels should not contact the ground during leveling.

1. Park tractor on a hard, level surface.
2. Stop engine and remove key.
3. CHECK: Tire pressure must be correct. (See Checking Tire Pressure in Service – Miscellaneous section.)
4. Pull lift lever all the way back to TRANSPORT (upper) position.

OPERATING

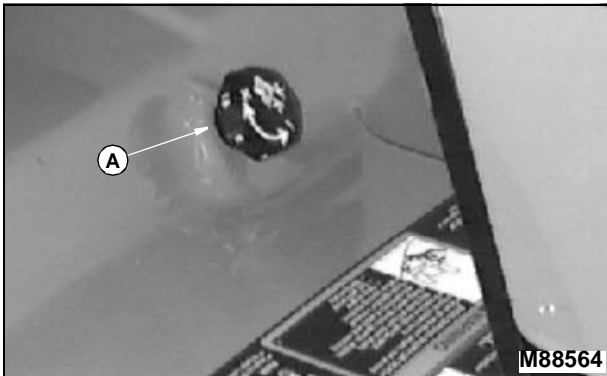

5. Turn mower depth control knob (A) to adjust cutting height to 50 mm (2 in).
6. Move lift lever forward to MOWING (lower) position.
7. Turn left blade so blade tip points straight forward.
8. Hold drive belt and turn right blade straight forward.
9. Measure from the front of each blade tip to the level surface. The front blade tips must be **6–9 mm (1/4–3/8 in.)** lower than rear blade tips or blades will cut grass twice and tips will turn brown.

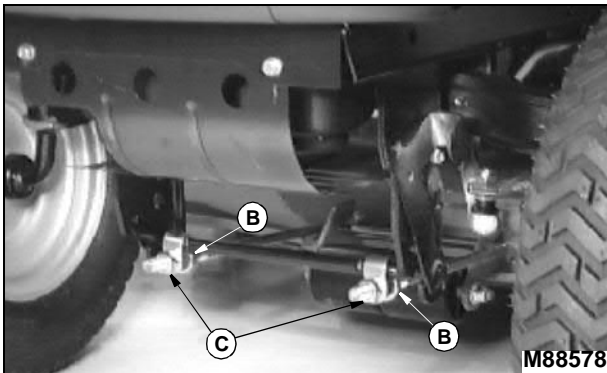

10. Loosen two rear nuts (B) on front lift rod assembly and turn two front nuts (C) clockwise to RAISE front of mower deck or counterclockwise to LOWER front of mower deck.
11. Tighten rear nuts (B) after adjustment is completed.
12. Check front-to-rear deck measurements and readjust if necessary.

Testing Safety Systems



CAUTION: Avoid injury, engine exhaust fumes can cause sickness or death.

If it is necessary to run an engine in an enclosed area, remove the exhaust fumes from the area with an exhaust pipe extension.

If you do not have an exhaust pipe extension, open the doors and get outside air into the area.

NOTE: Your Garden Tractor is equipped with a **ELECTRONIC SAFETY INTERLOCK**. Engine will not start unless: **PTO switch is DISENGAGED and brake pedal is depressed OR parking brake is set.**

Use the following checkout procedure to check for normal operation of tractor.

If there is a malfunction during one of these procedures, DO NOT operate tractor. (See your Sabre Service Center for service.)

Perform these tests in a clear open area. Keep bystanders away.

Test 1

Check operation of indicator lights:

1. Turn key to RUN position.

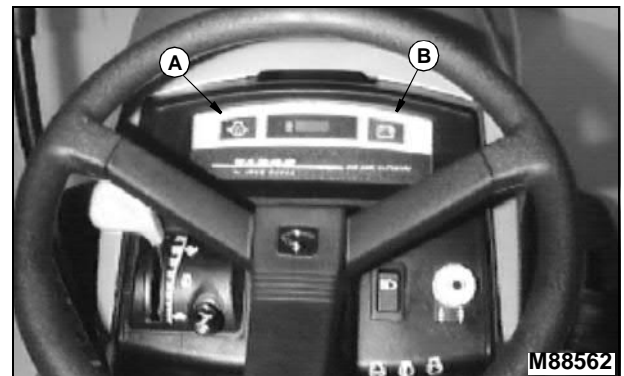

2. LOOK:

- 2554HV Only, Engine Oil Pressure Light (A) on MUST light.
- Battery Discharge Light (B) will momentarily light, this indicates the system is functioning properly. If the light remains on start engine and move throttle to high idle, the light should go out.



Suggest:

If the above button click is invalid.

Please download this document

first, and then click the above link

to download the complete manual.

Thank you so much for reading

OPERATING

NOTE: The battery discharge light may remain on for several minutes while the battery is being charged.

3. If one indicator does not light, see Replacing Indicator Light Bulb in Service – Electrical section.
4. If new indicator bulb does not light or no indicators work, see your Sabre Service Center for service.

Test 2

1. Operator on seat.



2. Unlock the park brake (A).
3. Push PTO switch (B) down to DISENGAGE.
4. Try to start engine.
5. Engine MUST NOT start. If engine starts, there is a problem with your safety interlock circuit.

Test 3

1. Operator on seat.



2. Lock the park brake (A).
3. Pull PTO switch (B) up to ENGAGE.
4. Try to start engine.
5. Engine MUST NOT start. If engine starts, there is a problem with your safety interlock circuit.

Test 4

1. Operator on seat.
2. Lock the park brake.

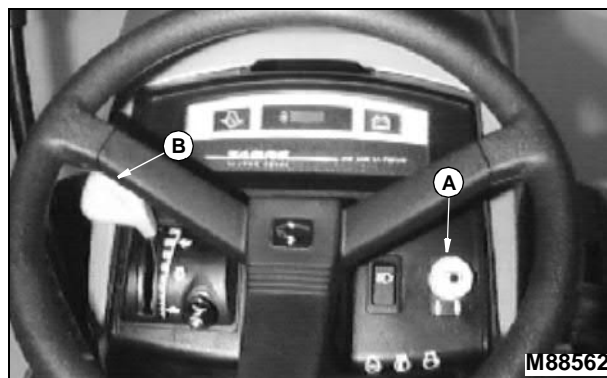

3. Push PTO switch (A) down to DISENGAGE.
4. Start engine and move throttle lever (B) to HALF-SPEED (⚡) position.
5. Pull PTO switch (A) up to ENGAGE.
6. Move throttle lever (B) to FAST (🔥) speed position.
7. Raise up off of seat. DO NOT get off tractor.
8. Engine MUST stop. If engine does not stop, there is a problem with your safety interlock circuit.

Test 5

1. Operator on seat.
2. Push brake pedal down.

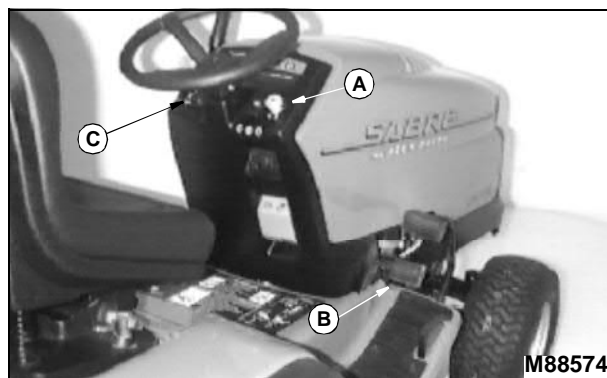

3. Push PTO switch (A) down to DISENGAGE.
4. Release forward travel pedal (B) to N (NEUTRAL) position.
5. Start engine and move throttle lever (C) to FAST (🔥) speed position.
6. Release brake slowly.
7. Raise up off of seat. DO NOT get off tractor.

<https://www.ebooklibonline.com>

Hello dear friend!

Thank you very much for reading.

Enter the link into your browser.

The full manual is available for immediate download.

<https://www.ebooklibonline.com>