

Sabre Yard Tractors

1842GV and 1842HV

1848GV and 1848HV

Serial No. (020,001-)



OPERATOR'S MANUAL

John Deere
Worldwide Commercial And
Consumer Equipment Division
OMM138147 J8

North American Version
Litho in U.S.A.
English

INTRODUCTION

THANK YOU for purchasing a John Deere product.

Read this manual and your attachment manual thoroughly. Failure to do so could result in personal injury or equipment damage.

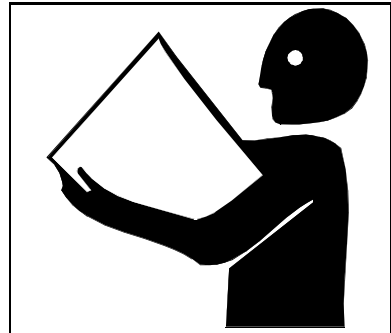

WARNING: The Engine Exhaust from this product contains chemicals known to the State of California to cause cancer, birth defects or other reproductive harm.

CALIFORNIA Proposition 65 Warning

This manual should be considered a permanent part of your machine and should remain with the machine when you sell it.

Product warranty is provided as part of John Deere's support program for customers who operate and maintain their equipment as described in this manual. The product warranty is explained on the warranty certificate you received from your dealer.

Measurements in this manual are metric units and their U.S. customary equivalents. RIGHT-HAND and LEFT-HAND sides are determined by facing in the direction the machine will travel when going forward. When you see a broken line arrow (----->), it indicates the part it is pointing to is hidden.

Record identification numbers below. Be sure to record all the numbers to help in tracing the machine if it is stolen. You also need to give these numbers to your dealer when you order parts.

DATE OF PURCHASE: _____

DEALER NAME: _____

DEALER PHONE: _____

Sabre® is a registered trademark of Deere & Company

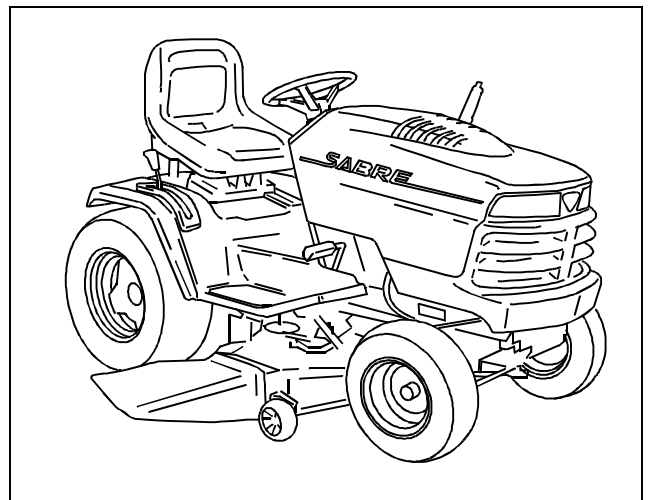

INTRODUCTION

Vehicle Serial Number:

□	□	□	□	□	□	□	□	□	□	□	□	□
---	---	---	---	---	---	---	---	---	---	---	---	---

Located on Rear of Tractor



Briggs & Stratton Engine Information

Model	Type	Code
□□□□□□	□□□□□□	□□□□□□□□

Located on Engine

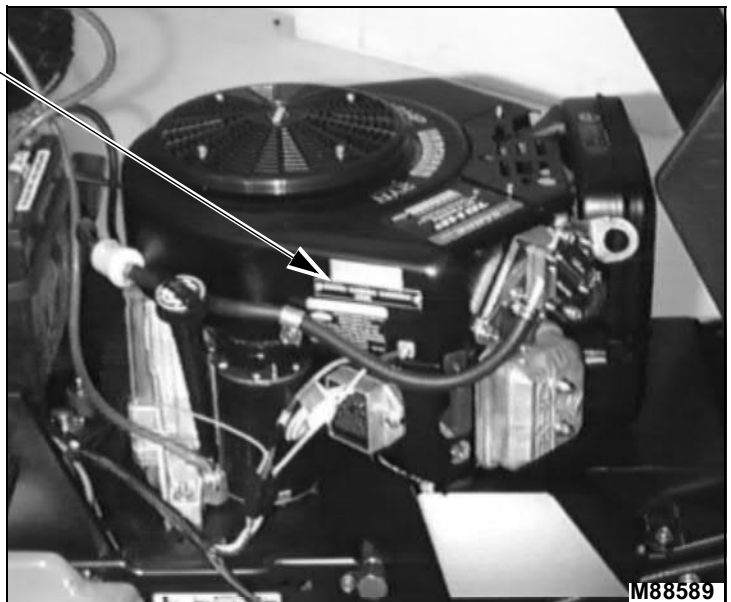

<https://www.ebooklibonline.com>

Hello dear friend!

Thank you very much for reading.

Enter the link into your browser.

The full manual is available for immediate download.

<https://www.ebooklibonline.com>

TABLE OF CONTENTS

Assembly	1
Safety Signs.....	8
Controls	11
Operating the Machine	13
Operating the Mower	30
Replacement Parts	37
Service Machine Safely	39
Service Interval Chart.....	41
Service Engine	43
Service Transmission.....	48
Service Mower	49
Service Electrical	56
Service Miscellaneous.....	61
Removing Mower	69
Installing Mower.....	71
Troubleshooting	72
Storing Machine.....	77
Specifications.....	80
Warranty	83
Index.....	89
Service Literature	93

All information, illustrations and specifications in this manual are based on the latest information at the time of publication. The right is reserved to make changes at any time without notice.

COPYRIGHT© 1998
Deere & Co.

John Deere Worldwide Commercial and
Consumer Equipment Division
Horicon, WI

All rights reserved
Previous Editions
COPYRIGHT© 1997

OMM138147 J8

ASSEMBLY

1842GV and 1842HV Only - Box of Parts

NOTE: *If you are missing any parts see the Replacement Parts section for additional service part numbers.*

- | | | |
|---|---|--------------------|
| A | Sabre Operator's Manual
Safety Video | M135884
M134321 |
| B | Steering Wheel | AM121918 |
| C | Bag of Hardware | H63686 |
| | • 1 - Shoulder bolt-Steering Wheel | M87404 |
| | • 1 - Nut- Steering Wheel | M63662 |
| | • 1 - Washer- Steering Wheel | 24H1721 |
| | • 2 - M8x16 Bolts- Battery | 19M7775 |
| | • 2 - M8x16 Nut- Battery | 14M7303 |
| | • 2 - Keys | M127340 |

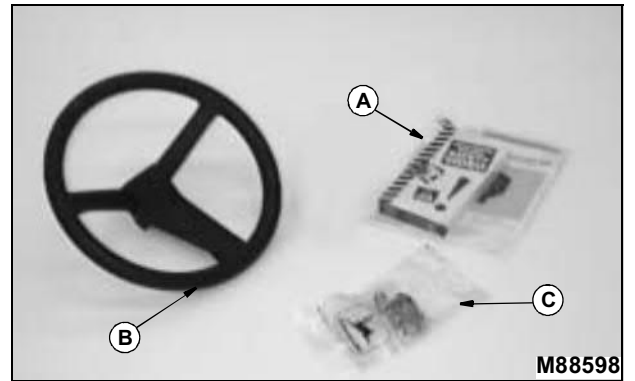

ASSEMBLY

1848GV and 1848HV Only - Box of Parts

NOTE: If you are missing any parts see the **Replacement Parts** section for additional service part numbers.

A	Sabre Operator's Manual Safety Video	M135884 M134321
B	Mower Gage Wheels (2)	M111489
C	Mower Drive Belt	M110312
D	Mower Discharge Chute with: Chute Pin Chute Spring Chute Hinge	M123859 M112899 M83410 M83411
E	Front Lift Rod Assembly: Rod Welded Pivot Clevis (2) Spacers (2) Lock Nuts (2) Jam Nuts (2)	M132735 AM119811 M113014 M110875 M85540 14M7275
F	Steering Wheel	AM121918
G	Bag of Hardware • 2 - Bolts • 2 - Nuts • 2 - Bushings • 2 - Washers • 1 - Shoulder Bolt-Steering Wheel • 1 - Nut-Steering Wheel • 1 - Washer-Steering Wheel • 2 - M8x16 Bolts-Battery • 2 - M8x16 Nut-Battery • 2 - M8x20 Bolts-Chute • 2 - M8x20 Nuts-Chute • 2 - Keys	H63686 19M7274 14M7396 M111491 M110698 M87404 M63662 24H1721 19M7775 14M7303 03M7184 14M7464 M127340

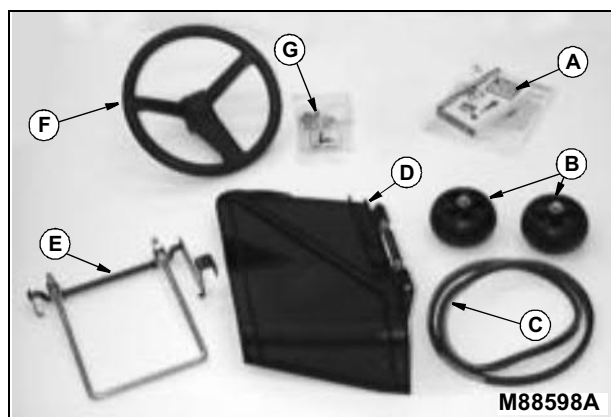

ASSEMBLY

Remove Packaging

CAUTION: Avoid eye injury. Wear eye protection when removing wire bands. Wire bands are under tension and could snap when removed.

Remove plastic and paper.

Remove wire bands (A) from front and rear tires.

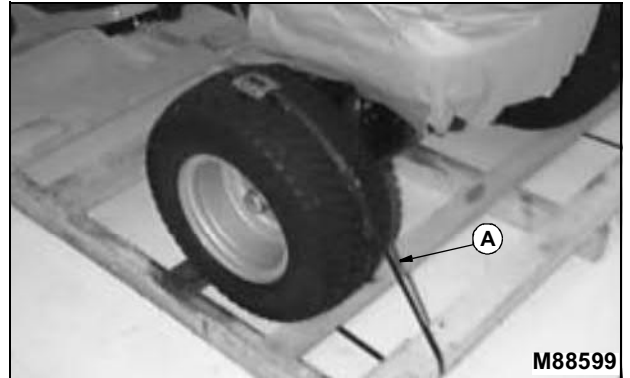

1848GV and 1848HV Only - Remove Mower Deck from Side of Crate

CAUTION: •Mower Deck is heavy. To avoid injury, use a hoist or safe lifting device when removing mower deck from crate.
•Mower Blades are sharp. Always wear gloves when handling mower deck.

1. Remove two bolts (A) from crate.
2. Using a hoist or a safe lifting device, remove mower deck from crate.



Install Steering Wheel

1. Put front wheels in the straight forward position.
2. Lubricate the steering shaft.
3. Install steering wheel with Sabre logo in the upright position.
4. Install shoulder bolt (A). Drive bolt in until head of bolt contacts steering wheel.
5. Install washer and nut (B).
6. Tighten lock nut until it is snug. Do not tighten lock nut to pull washer or head of bolt into steering wheel.

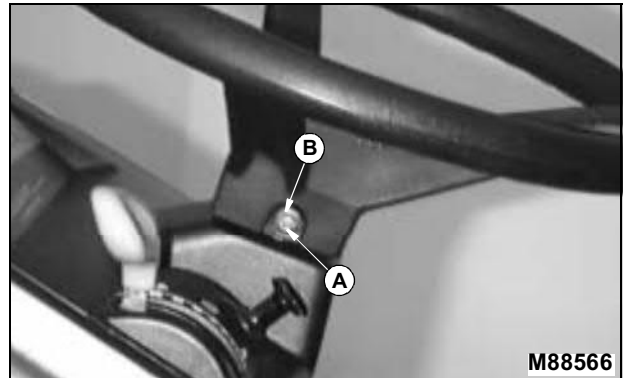

Remove Tractor from Crate

1. GEAR MODEL: Put transmission shift lever in N (Neutral).
AUTOMATIC MODEL: Pull out free-wheeling lever (A).
2. Carefully push tractor off crate.
3. Lock park brake.
4. AUTOMATIC MODEL: Push free-wheeling lever (A) IN before operating tractor.



ASSEMBLY

Connect and Check Battery

⚠ CAUTION: Prevent Battery Explosions:

- Keep sparks, lighted matches, and open flame away from the top of battery. Battery gas can explode.
- Never check battery charge by placing a metal object across the posts. Use a voltmeter or hydrometer.
- Do not charge a frozen battery; it may explode. Warm battery to 16° C (60° F)



IMPORTANT: This battery comes fully charged. If the mower is not used by the Service Expiration Date indicated on the battery, charge the battery. (See Charging the Battery in the Service - Electrical section.)

⚠ CAUTION: DO NOT attempt to open, add fluid or service battery. Any attempt to do so will void warranty and lead to possible injury.

NOTE: Do not remove the **BLACK negative (-) protective cap at this time.**

1. Remove and discard the RED positive (+) protective cap from the positive (+) battery terminal.
2. Connect blue harness wire (B) and RED positive (+) cable (A) to battery. Apply petroleum jelly or silicone spray to terminal to prevent corrosion. Make sure connection is tight. Install the red terminal cover.
3. Remove and discard the BLACK (-) protective cap from the negative battery terminal.
4. Connect black negative (-) cable (C) to battery. Apply petroleum jelly or silicone spray to terminal to prevent corrosion. Make sure connection is tight.

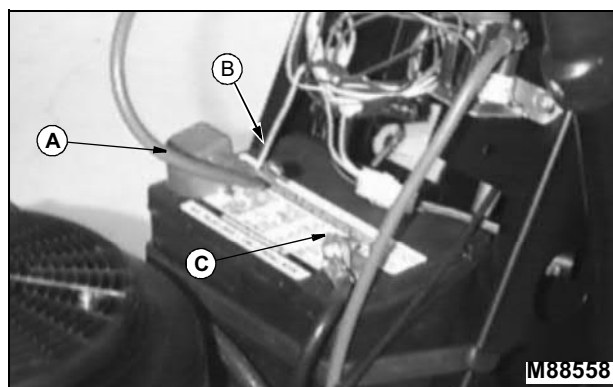

ASSEMBLY

1848GV and 1848HV Only - Assemble and Install Mower Deck

Install Rear Gage Wheels

1. Install rear gage wheels, one on each side, using bolt (A), bushing (B), washer (C), and tighten with nut (D).
2. Adjust gage wheels after mower deck is installed. (See Adjust Mower Gage Wheels in Operating the Mower section.)

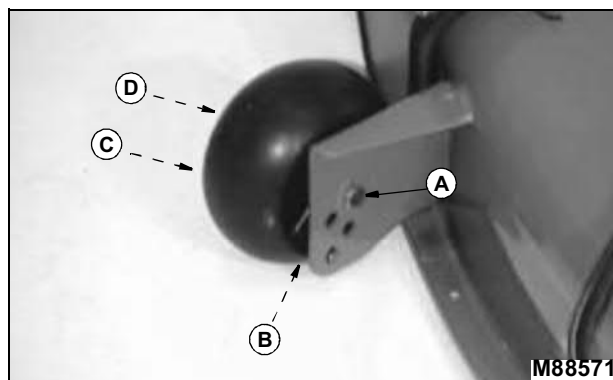

Install Mower Deck



CAUTION: Avoid injury, before installing mower on machine: **STOP** engine. Remove key. Wait for all moving parts to **STOP**.

Avoid injury from loaded spring: **LOCK** lift lever before installing mower.

Avoid injury from spring loaded rod: Make sure you have a tight grip on drive belt tension rod when installing.

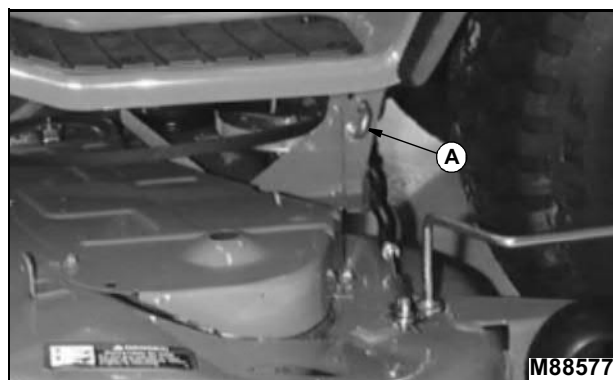

1. STOP engine, LOCK park brake, push PTO switch down to DISENGAGE, turn key to the OFF position, and remove key.
2. Raise mower lift lever to TRANSPORT (upper) position.
3. Slide mower under the tractor.
4. Put wood blocks under each side of mower.
5. Put mower lift lever in the MOWING (lower) position.
6. Install rear draft arms, one on each side of tractor, to mower lift brackets with spring loaded J-pins (A).
7. Put front lift rod assembly (B) in slotted brackets (C) on mower deck and install the front lift rod assembly to the front of the tractor frame.
8. Push up on lever (D) and lock into tractor frame.

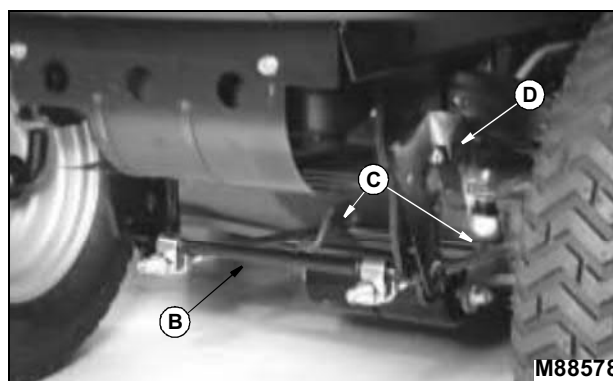

ASSEMBLY

- Put mower drive belt (E) on engine drive sheave.
- Push drive belt tension rod (F) into bracket (G).
- Raise mower lift lever to TRANSPORT (upper) position.
- Remove wood blocks from both sides of mower.
- Level mower. (See Leveling Mower in Operating the Mower section.)

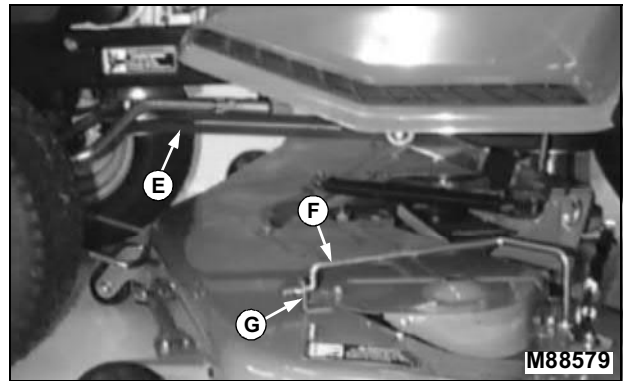

Install Mower Discharge Chute



CAUTION: To avoid injury: -NEVER operate mower without chute in place.

-Hold chute firmly on mower deck when installing, mower discharge chute is spring loaded.

-After installing chute on deck check to make sure hinge on chute is working properly by opening chute and releasing it. Chute **MUST** spring back to the **LOWERED** position.

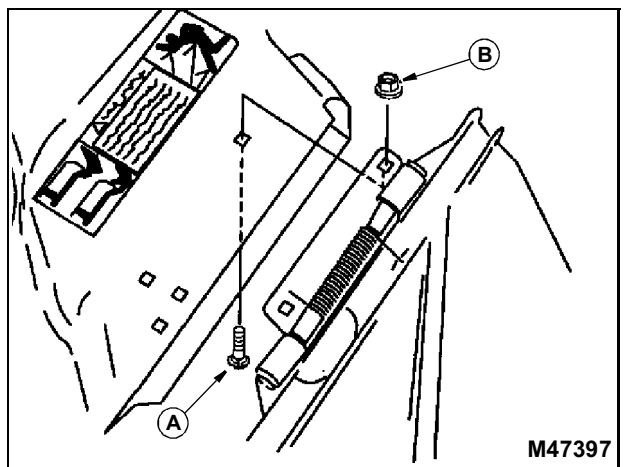

- Install mower discharge chute to mower deck with two M8 x 20 bolts (A) and lock nuts (B).
- Tighten nuts to 20 N•m (15 ft-lb).

Break-In Electric PTO Clutch

- Start engine and push throttle lever (A) up to full throttle (🐿) position.
- With no load on mower, ENGAGE PTO (B) and allow mower to run for 10 seconds.
- DISENGAGE PTO and wait 10 seconds.
- Repeat Step 2 for 12-15 cycles.
- PTO clutch is now properly burnished.



ASSEMBLY

Check Machine Safety System

Perform safety system check to make sure the electronic safety interlock circuit is functioning properly. Perform all six Tests. (See Testing Safety System in the Operating section)

Checking Tire Pressure

- ⚠ CAUTION:** Explosive separation of a tire and rim parts can cause serious injury or death:
- Do not attempt to mount a tire without the proper equipment and experience to perform the job.
 - Always maintain the correct tire pressure. Do not inflate the tires above the recommended pressure. Never weld or heat a wheel and tire assembly. The heat can cause an increase in air pressure resulting in a tire explosion. Welding can structurally weaken or deform the wheel.
 - When inflating tires, use a clip-on chuck and extension hose long enough to allow you to stand to one side and NOT in front of or over the tire assembly.
 - Check tires for low pressure, cuts, bubbles, damaged rims or missing lug bolts and nuts.



1. Check tires for damage.
2. Check tire pressure with an accurate gauge.
3. Add or remove air, if necessary:

Tire Size	Pressure-kPa (psi)
Front: 16 x 6.5	97 kPa (14 psi)
Rear: 23 x 9.5	83 kPa (12 psi)

SAFETY SIGNS

Safety-Alert Symbol

Read and recognize safety information. Be alert to the potential for personal injury when you see this safety-alert symbol.

On your machine safety labels, the words DANGER, WARNING, and CAUTION are used with this safety-alert symbol. DANGER identifies the most serious hazards.

In this manual, the word CAUTION and this symbol call attention to safety messages.

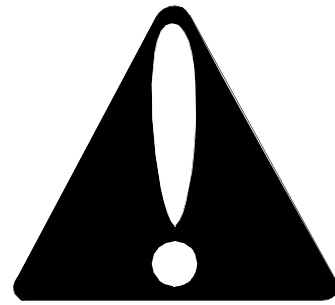

Machine Safety Labels

DANGER

ROTATING BLADES CUT OFF ARMS AND LEGS

- Do not mow when children or others are around
- Do not mow in reverse
- Look down and behind before and while backing
- Never carry children

WARNING

AVOID SERIOUS INJURY OR DEATH

- Drive up and down slopes, not across
- Avoid sudden turns
- If machine stops going uphill, stop blade and back down slowly
- Keep safety devices (guards, shields, and switches) in place and working
- Read operator's manual
- When leaving machine:
 - Stop engine
 - Set park brake
 - Remove key



SAFETY SIGNS

WARNING

LOADED SPRING

LOCK LIFT LEVER FORWARD BEFORE CHANGING ATTACHMENTS

Picture Note: One decal on each side of tractor frame



DANGER/POISON

SHIELD EYES.

EXPLOSIVE GASES CAN CAUSE BLINDNESS OR INJURY.

NO

- SPARKS
- FLAMES
- SMOKING

SULFURIC ACID CAN CAUSE BLINDNESS OR SEVERE BURNS

FLUSH EYES IMMEDIATELY WITH WATER.

GET MEDICAL HELP FAST.

MAINTENANCE-FREE

KEEP OUT OF THE REACH OF CHILDREN. DO NOT TIP. DO NOT OPEN BATTERY!

Picture Note: Located on Battery





Suggest:

If the above button click is invalid.

Please download this document

first, and then click the above link

to download the complete manual.

Thank you so much for reading

SAFETY SIGNS

DANGER

ROTATING BLADE

DO NOT PUT HANDS OR FEET UNDER OR INTO MOWER WHEN ENGINE IS RUNNING

THROWN OBJECTS

BEFORE MOWING, CLEAR AREA OF OBJECTS THAT MAY BE THROWN BY BLADE

DO NOT OPERATE MOWER WITHOUT DISCHARGE CHUTE OR ENTIRE GRASS CATCHER IN PLACE

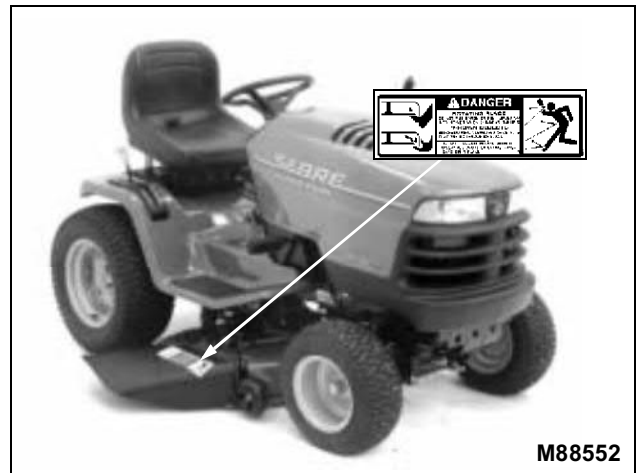

DANGER

ROTATING BLADE

DO NOT PUT HANDS OR FEET UNDER OR INTO MOWER WHEN ENGINE IS RUNNING

Picture Note: Located on Left-Hand side of deck



Certification Label

This OPEI label on your mower indicates that this model has been certified by an independent laboratory for compliance with American National Standard B-71.1-1996, "Safety Specifications" for Power Lawn Mowers, Lawn and Garden Tractors, and Lawn Tractors.



<https://www.ebooklibonline.com>

Hello dear friend!

Thank you very much for reading.

Enter the link into your browser.

The full manual is available for immediate download.

<https://www.ebooklibonline.com>