

**John Deere
JD850
Crawler Bulldozer**

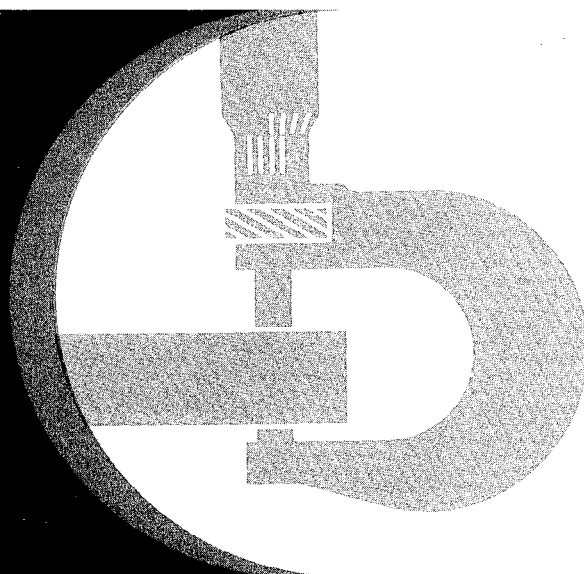

TECHNICAL MANUAL

**John Deere Dubuque Works
TM-1164 (Mar-86)**



Litho in U.S.A.

SECTION AND GROUP CONTENTS OF THIS MANUAL

SECTION I - GENERAL INFORMATION

- Group I - Contents, Index and Page List
- Group II - Introduction and Safety Information
- Group III - General Specifications
- Group IV - Predelivery, Delivery and After-Sale Services
- Group V - Lubrication

SECTION 1 - TRACKS

- Group 0130 - Track Systems
- Group 0199 - Specifications and Special Tools

SECTION 2 - AXLES AND SUSPENSION SYSTEMS

- Group 0201 - Drive Axle Housing and Support
- Group 0250 - Axle Shaft, Bearings and Reduction Gears
- Group 0299 - Specifications and Special Tools

SECTION 3 - TRANSMISSION

- Group 0315 - Controls
- Group 0325 - Input Drive Shafts and U-Joints
- Group 0360 - Hydraulic System
- Group 0370 - Clutch Disconnect and Controls
- Group 0399 - Specifications and Special Tools

SECTION 4 - ENGINE

- Group 0400 - Engine Removal and Installation
- Group 0401 - Crankshaft and Main Bearings
- Group 0402 - Camshaft and Valve Actuating Means
- Group 0403 - Connecting Rods and Pistons
- Group 0404 - Cylinder Block
- Group 0407 - Oiling System
- Group 0408 - Ventilating System
- Group 0409 - Cylinder Head and Valves
- Group 0410 - Exhaust Manifold
- Group 0413 - Fuel Injection System
- Group 0414 - Intake Manifold
- Group 0416 - Turbocharger
- Group 0417 - Water Pump
- Group 0418 - Thermostats, Housings and Piping
- Group 0419 - Oil Cooler
- Group 0420 - Fuel Filter
- Group 0421 - Fuel Transfer Pump
- Group 0422 - Starting Motor and Fastenings
- Group 0423 - Alternator and Generator Mounting
- Group 0429 - Fan Drive
- Group 0433 - Flywheel, Housing and Fasteners
- Group 0499 - Specifications and Special Tools

SECTION 5 - ENGINE AUXILIARY SYSTEMS

- Group 0505 - Cold Weather Starting Aids
- Group 0510 - Cooling System
- Group 0515 - Speed Controls
- Group 0520 - Intake System
- Group 0530 - External Exhaust System
- Group 0540 - Mounting Frame
- Group 0560 - External Fuel Supply System
- Group 0599 - Specifications and Special Tools

SECTION 8 - TRANSFER DRIVE

- Group 0841 - Housing and Covers
- Group 0851 - Gears, Shafts, Bearings
- Group 0899 - Specifications and Special Tools

SECTION 11 - PARKING-EMERGENCY BRAKE

- Group 1111 - Active Elements
- Group 1115 - Controls Linkage
- Group 1160 - Hydraulic System
- Group 1199 - Specifications and Special Tools

SECTION 15 - EQUIPMENT ATTACHING

- Group 1511 - Drawbar
- Group 1512 - Towbar

SECTION 16 - ELECTRICAL SYSTEM

- Group 1671 - Batteries, Supports and Cables
- Group 1672 - Alternator, Regulator and Charging System Wiring
- Group 1673 - Lighting System
- Group 1674 - Wiring Harness and Switches
- Group 1675 - System Controls
- Group 1676 - Instruments and Indicators
- Group 1699 - Specifications and Special Tools

SECTION 17 - FRAME, CHASSIS OR SUPPORTING STRUCTURE

- Group 1740 - Frame Installation
- Group 1746 - Frame Bottom Guards

SECTION 18 - OPERATOR'S STATION

- Group 1810 - Operator Enclosure
- Group 1821 - Seat
- Group 1830 - Heating and Air Conditioning
- Group 1899 - Specifications and Special Tools

SECTION AND GROUP CONTENTS OF THIS MANUAL—Continued

SECTION 19 - SHEET METAL AND STYLING

- Group 1910 - Hood or Engine Enclosure
- Group 1921 - Grille and Grille Housing
- Group 1927 - Fenders

SECTION 20 - SAFETY, CONVENIENCE AND MISCELLANEOUS

- Group 2003 - Fire Extinguisher
- Group 2004 - Horn and Warning Devices
- Group 2006 - Cigar Lighter

SECTION 32 - BULLDOZER

- Group 3201 - Blade
- Group 3215 - Controls Linkage
- Group 3240 - Frames
- Group 3260 - Hydraulic System
- Group 3299 - Specifications and Special Tools

SECTION 40 - PTO OR WINCH DRIVE

- Group 4041 - Housing and Covers

SECTION 42 - GROUND CONDITIONING TOOL

- Group 4215 - Controls Linkage
- Group 4260 - Hydraulic System

SECTION 90 - SYSTEM TESTING

- Group 9005 - General Information - Seven Basic Steps of Diagnosis and Testing and Operational Checkout Procedure

Group 9010 - Engine

Group 9015 - Electrical System

Group 9020 - Power Train

Group 9025 - Hydraulic System (Flow Meter)

Group 9025A - Hydraulic System (Analyzer)

Group 9026 - Hydrostatic System

Group 9030 - Miscellaneous Components

Group 9031 - Heating and Air Conditioning

Group 9035 - Specifications and Special Tools

<https://www.ebooklibonline.com>

Hello dear friend!

Thank you very much for reading.

Enter the link into your browser.

The full manual is available for immediate download.

<https://www.ebooklibonline.com>

ALPHABETICAL INDEX

A

After-sale inspection	I-IV-18 - I-IV-32
Air cleaner	I-IV-22
Air intake hose	I-IV-22
Alternator-fan compressor	
belt tension	I-IV-22
Batteries	I-IV-28
Cab air filter	I-IV-28
Charging system	I-IV-31
Engine coolant conditioner	
filter	I-IV-24
Engine crankcase oil and	
filter element	I-IV-19
Final drive housing oil level	I-IV-21
Fluid leakage	I-IV-32
Fuel tank sump	I-IV-24 - I-IV-25
Hydraulic brake (park brake)	I-IV-31
Hydraulic oil level	I-IV-20
Hydrostatic transmission	
oil level	I-IV-20
Indicator lights and gauges	I-IV-29 - I-IV-30
Lubrication	I-IV-27 - I-IV-28
Radiator coolant level	I-IV-24
Splitter gearbox oil level	I-IV-21
Track shoe cap screws	I-IV-27
Track tension adjustment	I-IV-25 - I-IV-26
Air conditioning relay	1674-4
Air conditioning system	1830-5 - 1830-30
Blower motor	1830-29
Components	1830-30
Compressor	1830-5 - 1830-20
Compressor relief valve	1830-26
Condenser	1830-21 - 1830-22
Evaporator	1830-24
Expansion valve	1830-25
High temperature switch	1830-28
Receiver - dryer	1830-23
Superheat shut-off switch	1830-27
Thermal fuse	1830-27
Thermostatic temperature control	
switch	1830-25 - 1830-26
Air conditioning system testing	9031-2 - 9031-19
Component location	9031-2 - 9031-3
Diagnosing malfunctions	9031-8
Diagnosis flow chart	9031-10
Operational diagnostic chart	9031-9
Safety precautions	9031-11
Schematic	9031-11

Air conditioning system testing—Continued

System service	9031-12 - 9031-19
Adding refrigerant - 12 to	
system	9031-18
Charging system	9031-16 - 9031-17
Discharging system	9031-14
Electrical testing	9031-14
Evacuating system	9031-15
Flushing system components	9031-19
Inspecting refrigerant	
hoses and tubing	9031-20
Leak testing	9031-19
Operational test	9031-14
Purging the system	9031-20
Pressure gauges	9031-12 - 9031-13
Visual operating checks	9031-7
Visual preliminary checks	9031-7
Air intake system, engine	0520-1 - 0520-2
Air restriction indicator	1676-2
Alarm, reverse warning	2004-2
Alternator and generator	
mounting	0423-1
Alternator, 16 amp	1672-2 - 1672-13
Components	1672-4
Test after assembly	1672-13
Alternator, 50 amp	1672-14 - 1672-26
Components	1672-16
Automatic control valve shut-	
off valve control	0315-15 - 0315-16
Automatic control valve variable	
orifice linkage	0315-12 - 0315-13
Auxiliary control linkage	4215-3 - 4215-6
Axle shaft, bearings, and	
reduction gears	0250-1 - 0250-18
Components	0250-1
Final drive housing cover with	
gears and shafts	0250-12 - 0250-18
Planet housing with pinions and	
shafts	0250-2 - 0250-11
Axles and suspension systems:	
Axle shaft, bearings and reduc-	
tion gears	0250-1 - 0250-18
Drive axle housing and support	0201-3 - 0201-6

B

Batteries, support and cables	1671-3 - 1671-7
Charging battery	1671-7
Inspection	1671-4 - 1671-5
Testing	1671-5 - 1671-6
Battery disconnect switch	1674-2
Blades, bulldozer	3201-3 - 3201-5

Block, cylinder	0404-1 - 0404-6
Blower motor	1830-29
Brake valve	1160-1 - 1160-4
Brakes, parking-emergency:	
Active elements	1111-3 - 1111-5
Controls linkage	1115-1 - 1115-2
Hydraulic system	1160-1 - 1160-4
Brush shields	1910-6
Bulldozer:	
Blades	3201-3 - 3201-5
Controls linkage	3215-1 - 3215-2
Frames	3240-1 - 3240-5
Hydraulic system	3260-1 - 3260-21
Control valve	3260-7 - 3260-12
Components	3260-9 - 3260-10
Cylinders	3260-13 - 3260-21
Dozer pump	3260-1 - 3260-4
Reservoir and filters	3260-5 - 3260-6
Bypass valve, transmission	0360-38 - 0360-39

C

Cab	1810-3 - 1810-6
Cab relay	1674-4
Camshaft and valve actuating means	0402-1 - 0402-4
Carrier rollers	0130-4 - 0130-6
Center frame	1740-5
Chain, track	0130-14 - 0130-23
Cigar lighter	2006-1
Circuit breakers	1674-5
Charge pump	0360-31 - 0360-32
Clutch disconnect and controls	0370-1 - 0370-6
Clutch elements	0370-3 - 0370-6
Controls	0370-1 - 0370-2
Cold weather starting aids	0505-3 - 0505-5
Engine coolant heater	0505-5
Starting aid adapter, line and nozzle	0505-4
Starting aid solenoid	0505-3 - 0505-4
Starting aid switch	0505-4
Component location:	
Air conditioning system	9031-2 - 9031-3
Electrical system	9015-2 - 9015-5
Engine system	9010-2 - 9010-4
Heating system	9031-2 - 9031-3
Hydraulic system (flow meter)	9025-3
Power train system	9020-2 - 9020-3
Compressor	1830-5 - 1830-20
Compressor relief valve	1830-26
Condenser	1830-21 - 1830-22
Connecting rods and pistons	0403-1 - 0403-6
Control valve, bulldozer	3260-7 - 3260-12
Controls linkage, bulldozer	3215-1 - 3215-2
Coolant filter/conditioner	0510-1 - 0510-3

Cooling systems, engine	0510-1 - 0510-3
Cover, PTO	4041-3
Cowl	1910-4
Crankshaft and main bearings	0401-1 - 0401-7
Crossbar and support	0130-11 - 0130-12
Cylinder block	0404-1 - 0404-6
Cylinder, bulldozer	3260-13 - 3260-21
Cylinder head and valves	0409-1 - 0409-6
Cylinder, track adjuster	0130-30 - 0130-32

D

Delco-Remy starting motor	0422-1 - 0422-10
Delivery service	I-IV-18
Diagnosing malfunctions:	
Air conditioning system	9031-8
Electrical system	9015-8 - 9015-10
Engine system	9010-5 - 9010-7
Heating system	9031-1
Hydraulic system (flow meter)	9025-19 - 9025-21
Power train system	9020-10 - 9020-11
Track	9030-1
Double selector valve	4260-1 - 4260-2
Dozer - see bulldozer	
Dozer pump	3260-1 - 3260-4
Drawbar	1511-3
Drive axle housing and support	0201-3 - 0201-6

E

Electrical sensing gauges and indicators	1676-4 - 1676-6
Electrical system testing	9015-1 - 9015-32
Block diagram	9015-6
Component location	9015-2 - 9015-5
Diagnosing malfunctions	9015-8 - 9015-10
Precautions	9015-11 - 9015-12
Schematic	9015-7, 9015-31
Testing and adjustments	9015-13 - 9015-30
Visual inspection	9015-12
Wiring diagram	9015-7, 9015-32
Electrical systems:	
Alternator, regulator and charging system wiring	1672-1 - 1672-26
Batteries, support and cables	1671-3 - 1671-7
Instruments and indicators	1676-1 - 1676-6
Lighting system	1673-1 - 1673-2
Wiring harness and switches	1674-1 - 1674-6
Engine:	
Alternator and generator mounting	0423-1
Camshaft and valve actuating means	0402-1 - 0402-5
Connecting rods and pistons	0403-1 - 0403-7
Crankshaft and main bearings	0401-1 - 0401-7
Cylinder block	0404-1 - 0404-7

Engine—Continued

Cylinder head and valves	0409-1 - 0409-6
Exhaust manifold	0410-1- 0410-2
Fan drive	0429-1
Flywheel, housing and fastenings	0433-1 - 0433-2
Fuel filter	0420-1- 0420-2
Fuel injection system	0413-1 - 0413-11
Fuel transfer pump	0421-1 - 0421-4
Intake manifold	0414-1
Oil cooler	0419-1 - 0419-2
Oiling system	0407-1 - 0407-4
Removal and installation	0400-5- 0400-9
Starting motor and fastenings	0422-1 - 0422-10
Thermostats, housing and water piping	0418-1- 0418-2
Turbocharger	0416-1 - 0416-8
Ventilating system	0408-1
Water pump	0417-1- 0417-6
Engine auxiliary systems:	
Cold weather starting aids	0505-3 - 0505-5
Cooling systems	0510-1- 0510-3
External exhaust systems	0530-1
External fuel supply systems	0560-1 - 0560-2
Intake system	0520-1- 0520-2
Mounting frame	0540-1
Speed controls	0515-1 - 0515-6
Engine coolant temperature gauge	1676-2
Engine oil pressure gauge	1676-3
Engine side shields	1910-5
Engine system testing	9010-1- 9010-14
Component location	9010-2 - 9010-4
Diagnosing malfunctions	9010-5 - 9010-7
Testing and adjustments	9010-10- 9010-14
Theory of operation	9010-1
Visual inspection	9010-8 - 9010-9
Evaporator	1830-24
Exhaust manifold	0410-1 - 0410-2
Exhaust systems, engine	0530-1
Expansion valve	1830-25
External exhaust system	0530-1
Extinguisher, fire	2003-3 - 2003-4

F

Fan drive	0429-1
Fenders	1927-1
Filter, fuel	0420-1 - 0402-2
Filters, transmission	0360-109
Fire extinguisher	2003-3 - 2003-4
Flywheel, housing and fastenings	0433-1 - 0433-2
Forward and reverse speed control	0315-8 - 0315-11
Frame bottom guards	1746-1 - 1746-2
Frame, center	1740-5
Frame, engine mounting	0540-1

Frame, main	1740-3 - 1740-4
Frame, track	0130-34- 0130-39
Frames, bulldozer	3240-1 - 3240-5
Front crossbar and support	0130-11 - 0130-12
Front idler	0130-24- 0130-29
Fuel filter	0420-1 - 0420-2
Fuel injection system	0413-1 - 0413-11
Fuel injection nozzles	0413-8- 0413-11
Fuel injection pump	0413-1 - 0413-7
Repair	0413-13 - 0413-19
Fuel tank, engine	0560-1- 0560-2
Fuel transfer pump	0421-1 - 0421-4
Fuses	1674-6

G

Gauge, engine coolant temperature	1676-2
Gauge, engine oil pressure	1676-3
Gauge, transmission oil pressure	1676-1
Gauge, transmission oil temperature	1676-2
Greases	I-V-2
Grille and grille housing	1921-1 - 1921-2
Guard, frame bottom	1746-1- 1746-2

H

Heating system	1830-1- 1830-3
Heating system testing	9031-1 - 9031-3
High temperature switch	1830-28
Hood	1910-3
Horn	2004-1
Hour meter	1676-4
Hydraulic system (analyzer)	
testing	9025A-1 - 9025A-12
Hydraulic system pretest check sheet	9025A-4
Operational checks	9025A-3
Pretest inspection	9025A-3
Symptom index	9025A-5
Tests	9025A-6 - 9025A-12
Hydraulic system (flow meter)	
testing	9025-1 - 9025-28
Component location	9025-3
Diagnosing malfunctions	9025-19 - 9025-21
Testing and adjustment	9025-23 - 9025-28
Theory of operation	9025-5 - 9025-18
Visual inspection	9025-22
Hydraulic system, ground conditioning tool	4260-1 - 4260-4
Hydraulic system, hydrostatic transmission	0360-1 - 0369-110
Hydraulic system, parking-emergency brakes	1160-1 - 1160-4

Hydrostatic system testing 9026-2 - 9026-155
Adjustment procedures 9026-111 - 9026-155
Automatic control valve P4
pressure adjustment 9026-133 - 9026-134
Automatic control valve vari-
able orifice installation
adjustment 9026-125 - 9026-126
Automatic control valve vari-
able orifice pressure
adjustment 9026-127 - 9026-128
Bleeding of the transmission
control circuit 9026-138 - 9026-140
Brake valve cable adjustment 9026-114
Engine speed adjustment 9026-153
Engine speed and transmission
control valve synchroniza-
tion 9026-117 - 9026-120
FNR speed control lever
linkage neutral
adjustment 9026-115 - 9026-116
Initial start-up of crawler
after transmission repair 9026-113
Pump displacement control
valve neutral adjust-
ment 9026-154 - 9026-155
Return-to-neutral cable
adjustment 9026-148 - 9026-149
Steering linkage adjust-
ment 9026-143 - 9026-144
Steering neutral stop
adjustment 9026-145 - 9026-149
Steering valve stop adjust-
ment on the transmission
control valve 9026-141 - 9026-142
Transmission automatic con-
trol valve shutoff valve
cable adjustment 9026-152
Transmission control valve
P1 overpressure relief
valve adjustment 9026-123
Transmission control valve
P2 pressure regulating
valve adjustment 9026-124
Transmission control valve
P3 speed control valve
adjustment 9026-129 - 9026-132
Transmission fluid heat-up
procedure 9026-121
Transmission full speed ad-
justment 9026-135 - 9026-137
Component location 9026-36 - 9026-42

Hydrostatic system testing—Continued
Diagnosing malfunctions 9026-43 - 9026-107
Diagnostic equipment 9026-44
Diagnostic procedures 9026-45 - 9026-72
Automatic control valve
accumulator (P9 check) 9026-70 - 9026-72
Automatic control valve
operational check 9026-66 - 9026-69
Engine horsepower check 9026-49 - 9026-50
Transmission charge pres-
sure loss isolation 9026-57 - 9026-58
Transmission control sys-
tem tracking check 9026-59 - 9026-65
Transmission pressures
test 9026-55 - 9026-56
Transmission volumetric ef-
ficiency test 9026-51 - 9026-54
Diagnostic symptoms 9026-73 - 9026-108
Symptoms index 9026-74
General Information 9026-2 - 9026-34
Brake valve 9026-32
Hydrostatic transmission 9026-2 - 9026-17
Oil cooler bypass valve 9026-33
Transmission control valve 9026-18 - 9026-32
Visual inspection 9026-34
Hydrostatic transmission 0360-1 - 0360-110
Bypass valve 0360-38 - 0369-39
Charge pump 0360-31 - 0360-32
Cleanliness 0360-2
Components 0360-1
Hydrostatic transmission sump 0360-108
Installation 0360-4
Manifold valve assembly 0360-64 - 0360-67
Motor displacement control
valve 0360-61 - 0360-63
Oil cooler 0360-103
Oil cooler bypass valve 0360-104 - 0360-105
Pump displacement control
valve 0360-33 - 0360-37
Start-up procedure 0360-5
Transmission control valve 0360-68 - 0360-102
Assembly 0360-86 - 0360-101
Automatic control valve 0360-88 - 0360-90
Automatic control valve
shutoff valve 0360-87
Automatic control valve
variable orifice 0360-92 - 0360-94
FNR valve 0360-99 - 0360-100
P1 over pressure relief
valve 0360-86
P2 pressure regulator
valve 0360-86
Port plate and cover
assembly 0360-101

Hydrostatic transmission—Continued

Assembly—Continued

Speed control valve 0360-97 - 0360-98

Steering valve 0360-95 - 0360-96

Steering valve orifices 0360-91

Disassembly 0360-70 - 0360-84

Automatic control valve . . 0360-73 - 0360-75

Automatic control valve
 shutoff valve 0360-73

Automatic control valve
 variable orifice 0360-76 - 0360-77

FNR valve 0360-82 - 0360-83

P1 over pressure relief
 valve 0360-72

P2 pressure regulator
 valve 0360-72

Speed control valve 0360-84

Steering valve 0360-79 - 0360-81

Steering valve orifices 0360-75

Transmission control valve
 assembly 0360-78

Transmission filters 0360-109

Transmission motor 0360-40 - 0360-60

Transmission operating pres-
 sure valve 0360-106 - 0360-107

Transmission pump 0360-6 - 0360-30

Hydrostatic transmission sump 0360-108

I

Idler, track 0130-24 - 0130-29

Input drive shafts and U-joints 0325-1 - 0325-2

Instrument panel 1676-1

Instruments and indicators 1676-1 - 1676-6

Electrical sensing gauges
 and indicators 1676-4 - 1676-6

Mechanical sensing gauges and
 indicators 1676-1 - 1676-3

Intake manifold 0414-1

Intake system, engine 0520-1 - 0520-2

K

Key switch 1674-3

L

Light switch 1673-2

Lighter, cigar 2006-1

Lights 1673-1

Lubrication I-V-1 - I-V-2

M

Main bearings and crankshaft 0401-1 - 0401-7

Main frame 1740-3 - 1740-4

Malfunctions, diagnosing:

Air conditioning system 9031-8

Electrical system 9015-8 - 9015-10

Engine system 9010-5 - 9010-7

Heating system 9031-1

Hydraulic system (flow meter) 9025-19 - 9025-21

Power train system 9020-10 - 9020-11

Track 9030-1

Manifold, exhaust 0410-1 - 0410-2

Manifold, intake 0414-1

Manifold valve assembly 0360-64 - 0360-67

Mechanical sensing gauges and
 indicators 1676-1 - 1676-3

Motor, Delco-Remy starting 0422-1 - 0422-10

Motor displacement control valve 0360-61 - 0360-63

Motor, transmission 0360-40 - 0360-60

Mounting frame, engine 0540-1

Muffler 0530-1

N

Nozzle, fuel injection 0413-8 - 0413-11

O

Oil cooler bypass valve 0360-104 - 0360-105

Oil cooler, engine 0419-1 - 0419-2

Oil cooler, transmission 0360-103

Oiling system, engine 0407-1 - 0407-4

Oil pump 0407-1 - 0407-3

Components 0407-2

Oils I-V-2

P

Parking-emergency brakes:

Active elements 1111-3 - 1111-5

Controls linkage 1115-1 - 1115-2

Hydraulic system 1160-1 - 1160-4

Pistons and connecting rods 0403-1 - 0403-6

Power train system testing 9020-1 - 9020-12

Block diagram 9020-9

Component location 9020-2 - 9020-3

Diagnosing malfunctions 9020-10 - 9020-11

Parking brake and final
 drive cross section 9020-8

Theory of operation 9020-5 - 9020-7

Visual inspection 9020-11

Predelivery service I-IV-1 - I-IV-17

Air cleaner I-IV-1

Air intake hose I-IV-2

Alternator - fan compressor
 belt tension I-IV-6 - I-IV-7

Batteries I-IV-2

Crankcase oil level I-IV-3

Engine speeds I-IV-7 - I-IV-10

Final check I-IV-17

Predelivery service—Continued

Final drive housing oil level	I-IV-4
Fuel filters	I-IV-2
Fuel tank	I-IV-2
Fuel tank sump	I-IV-3
Hardware torque valves	I-IV-17
Hydraulic brake (park brake)	I-IV-14
Hydraulic oil level	I-IV-5
Hydrostatic transmission oil level	I-IV-5
Indicator lights and gauges	I-IV-12 - I-IV-13
Lights	I-IV-14
Lubrication	I-IV-15 - I-IV-16
Neutral lock lever operation	I-IV-16
Radiator	I-IV-3
Seat operation	I-IV-12
Splitter gearbox oil level	I-IV-4
Steering	I-IV-15
Track rollers, upper idlers and front idler oil levels	I-IV-3
Track tension adjustment	I-IV-10 - I-IV-11
Transmission shifting	I-IV-14
PTO cover	4041-3
Pump displacement control valve	0360-33 - 0360-37
Pump, dozer	3260-1 - 3260-4
Pump, engine oil	0407-1 - 0407-3
Pump, engine water	0417-1 - 0417-6
Pump, fuel injection	0413-1 - 0413-7
Pump, fuel transfer	0421-1 - 0421-4
Pump, transmission	0360-6 - 0360-30
Pump, transmission charge	0360-31 - 0360-32

R

Radiator	0510-1 - 0510-3
Receiver-dryer	1830-23
Recoil spring	0130-32 - 0130-34
Relays	1674-4
Reservoir and filters, bulldozer	3260-5 - 3260-6
Reverse warning alarm	2004-2
Rock guards and track guides	0130-3
Rocker arm assembly	0402-2, 0402-3, 0409-2
Roller, track	0130-7 - 0130-10
ROPS, with cab	1810-7
ROPS, without cab	1810-8

S

Safety information	I-II-1 - I-II-7
Seat	1821-1 - 1821-5
Service, delivery	I-IV-18
Shield, brush	1910-6
Shield, engine side	1910-5
Shoe track	0130-13
Side shields, engine	1910-5

Special tools:

Air conditioning system	1899-3
Alternator, regulator and charging system wiring	1699-8 - 1699-9
Batteries, support and cables	1699-7
Bulldozer hydraulic system	3299-5
Camshaft and valve actuating means	0499-28 - 0499-29
Clutch disconnect and controls	0399-21
Connecting rods and pistons	0499-30
Crankshaft and main bearings	0499-27
Cylinder block	0499-31
Cylinder head and valves	0499-32 - 0499-33
Drive axle housing and support	0299-5 - 0299-6
Electrical system testing	9035-11
Engine removal and installation	0499-26
Engine system testing	9035-3 - 9035-5
Fuel injection system	0499-34 - 0499-36
Heating and air conditioning system testing	9035-20
Hydraulic system	0399-15 - 0399-20
Hydraulic system testing	9035-15
Hydrostatic system testing	9035-18
Starting motor and fastenings	0499-39 - 0499-40
Track systems	0199-6 - 0199-8
Transfer drive gears, shafts, bearings	0899-2
Turbocharger	0499-37
Water pump	0499-38
Specifications and torque values	
Air conditioning system	1899-1 - 1899-2
Alternator and generator mounting	0499-24
Alternator, regulator and charging system wiring	1699-1 - 1699-5
Axle shaft, bearings and reduction gears	0299-2 - 0299-5
Batteries, support and cables	1699-1
Bulldozer frames	3299-1
Bulldozer hydraulic system	3299-2 - 3299-4
Camshaft and valve actuating means	0499-5 - 0499-6
Center frame	1799-1
Clutch disconnect and controls	0399-14
Connecting rods and pistons	0499-7 - 0499-8
Controls	0399-1
Cooling systems, engine	0599-1
Crankshaft and main bearings	0499-3 - 0499-4
Cylinder block	0499-9 - 0499-10
Cylinder head and valves	0499-12 - 0499-15
Drive axle housing and support	0299-1
Electrical system testing	9035-6 - 9035-9
Engine break-in	0499-1
Engine removal and installation	0499-2
Engine system testing	9035-1 - 9035-2

Specifications and torque values—Continued

Exhaust manifold	0499-15
External exhaust system	0599-11
External fuel supply system, engine	0599-1
Fan drive	0499-25
Flywheel, housing and fastenings	0499-25
Fuel filter	0499-20
Fuel injection system	0499-16 - 0499-17
Fuel transfer pump	0499-21
General	I-III-1 - I-III-4
Angle dozer dimensions	I-III-4
Blade	I-III-2
Brakes	I-III-1
Bulldozer dimensions	I-III-3
Capacities	I-III-2
Drawbar pull	I-III-1
Engine	I-III-1
Hydraulic cylinders	I-III-2
Hydraulic system	I-III-2
Power	I-III-1
Special equipment	I-III-2
Standard equipment	I-III-2
Steering	I-III-1
Tracks	I-III-2
Transmission	I-III-1
Heating and air conditioning sys- tem testing	9035-19
Hydraulic system	0399-3 - 0399-13
Hydraulic system (analyzer) testing	9035-14
Hydraulic system (flow meter) testing	9035-13
Hydrostatic system testing	9035-16 - 9035-17
Input drive shafts and U-joints	0399-2
Instruments and indicators	1699-6
Intake manifold	0499-17
Lighting system	1699-5
Miscellaneous components system testing	9035-21 - 9035-22
Mounting frame, engine	0599-1
Oil cooler	0499-21
Oiling system	0499-11 - 0499-12
Parking-emergency brakes active elements	1199-1
Parking-emergency brakes hydraulic system	1199-2
Power train system testing	9035-12
Speed controls, engine	0599-1
Starting motor and fastenings	0499-22 - 0499-24
Thermostats, housings and water piping	0499-20
Track systems	0199-1 - 0199-5
Transfer drive gears, shafts, bearings	0899-1 - 0899-2

Specifications and torque values—Continued

Turbocharger	0499-27 - 0499-20
Water pump	0499-19 - 0499-20
Wiring harness and switches	1699-6
Speed control, forward and reverse	0315-8 - 0315-10
Speed control support	0315-14
Speed controls, engine	0515-1 - 0515-6
Splitter housing:	
Gears, shafts, bearings	0851-1 - 0851-7
Housings and covers	0841-3 - 0841-4
Sprocket	0130-39 - 0130-40
Start-up procedure, transmission	0360-5
Starter switch	1674-3
Starting aids, cold weather	0505-3 - 0505-5
Starting circuit relay	1674-4
Starting motor and fastenings	0422-1 - 0422-10
Assembly	0422-9 - 0422-10
Components	0422-5 - 0422-6
Installation	0422-10
Operational theory	0422-1 - 0422-2
Repair	0422-5 - 0422-9
Testing solenoid	0422-3 - 0422-4
Steering linkage	0315-4 - 0315-7
Storage of crawler	I-IV-1
Sump, hydrostatic transmission	0360-108
Superheat shut-off switch	1830-27
Switch, battery disconnect	1674-2
Switch, high temperature	1830-28
Switch, key	1674-3
Switch, light	1673-2
Switch, starter	1674-3
Switch, starting aid	0505-4
Switch, superheat shut-off	1830-27
Switch, thermostatic temperature control	1830-25 - 1830-26
Switch, wiper	1674-3

T

Tests and adjustments:

Air conditioning system	9031-12 - 9031-19
Adding Refrigerant-12 to system	9031-18
Charging system	9031-16 - 9031-17
Discharging system	9031-14
Electrical testing	9031-14
Evacuating system	9031-15
Flushing system components	9031-19
Inspecting refrigerant hoses and tubing	9031-19
Leak testing	9031-19
Operational test	9031-14
Pressure gauges	9031-12 - 9031-13

Tests and adjustments—Continued

Battery 1671-5 - 1671-6
 High-rate discharge test 1671-6
 Specific gravity cell comparison test 1671-5
Compressor leak testing 1830-18 - 1830-19
 Discharge to suction side
 leak test 1830-19
 Shaft seal leak test 1830-18
Electrical system 9015-13 - 9015-30
 Accessory circuits 9015-25 - 9015-30
 Batteries 9015-13
 Charging circuit - 16 amp
 alternator 9015-20 - 9015-22
 Charging circuit - 50 amp
 alternator 9015-23 - 9015-25
 Starting circuit 9015-14 - 9015-19
 System short test 9015-13
Engine system 9010-10 - 9010-14
 Air restriction indicator
 test 9010-14
 Alternator and fan belt
 adjustments 9010-12
 Aneroid adjustments 9010-14
 Compression pressure test 9010-10
 Engine oil pressure check 9010-10
 Engine output check 9010-10 - 9010-11
 Fuel transfer pump pressure
 test 9010-12
 Intake manifold pressure test 9010-14
 Radiator leakage check 9010-11
 Speed control adjustment 9010-13
Heating system 9031-1 - 9031-3
Hydraulic system (analyzer) 9025A-6 - 9025A-12
 Cylinder leakage test 9025A-10 - 9025A-11
 Function leakage test 9025A-9 - 9025A-10
 Hydraulic pump test 9025A-7 - 9025A-9
 Parts list for tests 9025A-12
 System relief valve test 9025A-6 - 9025A-7
Hydraulic system (flow meter) 9025-23 - 9025-28
 Cycle time check 9025-25
 Dozer circuit leakage check 9025-23
 Flow meter tests 9025-26
 Hydraulic circuit tests 9025-28
 Hydraulic sump check 9025-25
 Lift control valve lift
 check test 9025-23
 Lift cylinder leakage check 9025-25
 Oil lines and hoses check 9025-23
 Pump flow tests 9025-26 - 9025-27
 System relief pressure setting check 9025-25
 Test diagnosis 9025-28

Tilt control valve lift
 check test 9025-24
 Tilt cylinder leakage check 9025-24
Power train 9020-12
Track adjustment 9030-2 - 9030-3
Turbocharger 0416-2
Thermal fuse 1830-27
Thermostatic temperature control
 switch 1830-25 - 1830-26
Thermostats, housing and water
 piping 0418-1 - 0418-2
Towbar 1512-1
Track systems 0130-3 - 0130-40
 Carrier rollers 0130-4 - 0130-6
 Front idler 0130-24 - 0130-29
 Front crossbar and support 0130-11 - 0130-12
 Recoil spring 0130-32 - 0130-34
 Rock guards and track guides 0130-3
 Sprocket 0130-39 - 0130-40
 Track adjuster cylinder 0130-30 - 0130-32
 Track chain assembly 0130-14 - 0130-23
 Track frame and pivot shaft 0130-34 - 0130-39
 Track rollers 0130-7 - 0130-10
 Track shoes 0130-13
Track testing 9030-1 - 9030-3
 Adjustment 9030-2 - 9030-3
 Diagnosing malfunctions 9030-1
Transfer drive:
 Gears, shafts, bearings 0851-1 - 0851-7
 Housings and covers 0841-3 - 0841-4
Transmission control valve 0360-68 - 0360-102
 Assembly 0360-86 - 0360-101
 Automatic control valve 0360-88 - 0360-90
 Automatic control valve
 shutoff valve 0360-87
 Automatic control valve
 variable orifice 0360-92 - 0360-94
 FNR valve 0360-99 - 0360-100
 P1 over pressure relief valve 0360-86
 P2 pressure regulator valve 0360-86
 Port plate and cover
 assembly 0360-101
 Speed control valve 0360-97 - 0360-98
 Steering valve 0360-95 - 0360-96
 Steering valve orifices 0360-91
Disassembly 0360-70 - 0360-84
 Automatic control valve 0360-73 - 0360-75
 Automatic control valve
 shutoff valve 0360-73
 Automatic control valve
 variable orifice 0360-76 - 0360-77
 FNR valve 0360-82 - 0360-83

Transmission control valve—Continued
Assembly—Continued
P1 over pressure relief valve 0360-72
P2 pressure regulator valve 0360-72
Speed control valve 0360-84
Steering valve 0360-79 - 0360-81
Steering valve orifices 0360-75
Transmission control valve
assembly 0360-78
Transmission controls 0315-3 - 0315-16
Automatic control valve shut-
off valve control 0315-15 - 0315-16
Automatic control valve variable
orifice linkage 0315-12 - 0315-13
Components 0315-3
Forward and reverse speed
control 0315-3 - 0315-10
Speed control support 0315-14
Steering linkage 0315-4 - 0315-7
Transmission filters 0360-109
Transmission motor 0360-40 - 0360-60
Transmission oil filter indicator 1676-5
Transmission oil pressure gauge 1676-1
Transmission oil temperature gauge 1676-2
Transmission operating pressure
valve 0360-106 - 0360-107
Transmission pump 0360-6 - 0360-30
Turbocharger 0416-1 - 0416-8
Repair 0416-3 - 0416-6
Testing 0416-2

V

Vacuum relief valve 0360-110
Valve, brake 1160-1 - 1160-4
Valve, compressor relief 1830-26
Valve, double selector 4260-1 - 4260-2
Valve, expansion 1830-24
Valve, manifold transmission 0360-64 - 0360-67
Valve, motor displacement
control 0360-61 - 0360-63
Valve, oil cooler bypass 0360-104 - 0360-105
Valve, pump displacement control
valve 0360-33 - 0360-37
Valve, transmission bypass 0360-38 - 0360-39

Valve, transmission control 0360-68 - 0360-102
Assembly 0360-86 - 0360-101
Automatic control valve 0360-88 - 0360-90
Automatic control valve
shutoff valve 0360-87
Automatic control valve
variable orifice 0360-92 - 0360-94
FNR valve 0360-99 - 0360-100
P1 over pressure relief valve 0360-86
P2 pressure regulator valve 0360-86
Port plate and cover assembly 0360-101
Speed control valve 0360-97 - 0360-98
Steering valve 0360-95 - 0360-96
Steering valve orifices 0360-91
Disassembly 0360-70 - 0360-84
Automatic control valve 0360-73 - 0360-75
Automatic control valve
shutoff valve 0360-73
Automatic control valve
variable orifice 0360-76 - 0360-77
FNR valve 0360-82 - 0360-83
P1 over pressure relief valve 0360-72
P2 pressure regulator valve 0360-72
Speed control valve 0360-84
Steering valve 0360-79 - 0360-81
Steering valve orifices 0360-75
Transmission control valve
assembly 0360-78
Valve, transmission operating
pressure 0360-106 - 0360-107
Valve, vacuum relief 0360-110
Valves and cylinder head, engine 0409-1 - 0409-6
Ventilating system, engine 0408-1
Vibration damper 0415-1 - 0415-2

W

Water manifold 0418-1 - 0418-2
Water pump, engine 0417-1 - 0417-6
Windshield, ROPS without cab 1810-7
Windshield washer 1810-10 - 1810-11
Windshield wiper, front 1810-9
Windshield wiper, rear 1810-10
Wiper switch 1674-3
Wiring harness 1674-1







**COMPLETE PAGE LISTING
 WITH LATEST DATE LINES**

I-I-1,2	(Feb-78)	1-0130-23,24	(Feb-78)	3-0360-25,26	(Feb-78)
I-I-3,4	(Feb-78)	1-0130-25,26	(Feb-78)	3-0360-27,28	(Feb-78)
I-I-5,6	(Feb-78)	1-0130-27,28	(Feb-78)	3-0360-29,30	(Feb-78)
I-I-7,8	(May-79)	1-0130-29,30	(May-79)	3-0360-31,32	(May-79)
I-I-9,10	(May-79)	1-0130-31,32	(Feb-78)	3-0360-33,34	(Feb-78)
I-I-11,12	(May-79)	1-0130-33,34	(May-79)	3-0360-35,36	(Feb-78)
I-I-13,14	(May-79)	1-0130-35,36	(Feb-78)	3-0360-37,38	(Feb-78)
I-I-15,16	(May-79)	1-0130-37,38	(Feb-78)	3-0360-39,40	(Feb-78)
I-I-17,18	(May-79)	1-0130-39,40	(May-79)	3-0360-41,42	(Feb-78)
I-I-19,20	(May-79)	1-0199-1,2	(May-79)	3-0360-43,44	(Feb-78)
I-I-21,22	(May-79)	1-0199-3,4	(May-79)	3-0360-45,46	(Feb-78)
I-I-23,24	(May-79)	1-0199-5,6	(Feb-78)	3-0360-47,48	(Feb-78)
I-I-25,26*	(Feb-78)	1-0199-7,8	(Feb-78)	3-0360-49,50	(May-79)
I-I-27,28*	(Feb-78)			3-0360-51,52	(Feb-78)
I-I-29,30*	(Feb-78)	2-0201-1,2	(May-79)	3-0360-53,54	(May-79)
I-I-31,32*	(Feb-78)	2-0201-3,4	(May-79)	3-0360-55,56	(Feb-78)
I-II-1,2	(Feb-78)	2-0201-5,6	(May-79)	3-0360-57,58	(Feb-78)
I-II-3,4	(Feb-78)	2-0250-1,2	(Feb-78)	3-0360-59,60	(Feb-78)
I-II-5,6	(Feb-78)	2-0250-3,4	(Feb-78)	3-0360-61,62	(Feb-78)
I-II-7,8	(Feb-78)	2-0250-5,6	(Feb-78)	3-0360-63,64	(Feb-78)
I-III-1,2	(Feb-78)	2-0250-7,8	(Feb-78)	3-0360-65,66	(Feb-78)
I-III-3,4	(Feb-78)	2-0250-9,10	(Feb-78)	3-0360-67,68	(Feb-78)
I-IV-1,2	(Feb-78)	2-0250-11,12	(May-79)	3-0360-69,70	(Feb-78)
I-IV-3,4	(Feb-78)	2-0250-13,14	(May-79)	3-0360-71,72	(Feb-78)
I-IV-5,6	(Feb-78)	2-0250-15,16	(Feb-78)	3-0360-73,74	(Feb-78)
I-IV-7,8	(Feb-78)	2-0250-17,18	(May-79)	3-0360-75,76	(May-79)
I-IV-9,10	(May-79)	2-0250-19,20	(May-79)	3-0360-77,78	(May-79)
I-IV-11,12	(May-79)	2-0299-1,2	(Feb-78)	3-0360-79,80	(Feb-78)
I-IV-13,14	(Feb-78)	2-0299-3,4	(Feb-78)	3-0360-81,82	(May-79)
I-IV-15,16	(Feb-78)	2-0299-5,6	(Feb-78)	3-0360-83,84	(May-79)
I-IV-17,18	(Feb-78)	3-0315-1,2	(May-79)	3-0360-85,86	(May-79)
I-IV-19,20	(Feb-78)	3-0315-3,4	(Feb-78)	3-0360-87,88	(Feb-78)
I-IV-21,22	(Feb-78)	3-0315-5,6	(Feb-78)	3-0360-89,90	(Feb-78)
I-IV-23,24	(Feb-78)	3-0315-7,8	(Feb-78)	3-0360-91,92	(May-79)
I-IV-25,26	(May-79)	3-0315-9,10	(May-79)	3-0360-93,94	(May-79)
I-IV-27,28	(Feb-78)	3-0315-11,12	(Feb-78)	3-0360-95,96	(Feb-78)
I-IV-29,30	(Feb-78)	3-0315-13,14	(Feb-78)	3-0360-97,98	(Feb-78)
I-IV-31,32	(Feb-78)	3-0315-15,16	(Feb-78)	3-0360-99,100	(May-79)
I-V-1,2	(Feb-78)	3-0325-1,2	(Feb-78)	3-0360-101,102	(Feb-78)
		3-0360-1,2	(Feb-78)	3-0360-103,104	(Feb-78)
1-0130-1,2	(Feb-78)	3-0360-3,4	(May-79)	3-0360-105,106	(Feb-78)
1-0130-3,4	(Feb-78)	3-0360-5,6	(May-79)	3-0360-107,108	(Feb-78)
1-0130-5,6	(May-79)	3-0360-7,8	(Feb-78)	3-0360-109,110	(May-79)
1-0130-7,8	(Feb-78)	3-0360-9,10	(Feb-78)	3-0399-1,2	(Feb-78)
1-0130-9,10	(May-79)	3-0360-11,12	(Feb-78)	3-0399-3,4	(Feb-78)
1-0130-11,12	(May-79)	3-0360-13,14	(Feb-78)	3-0399-5,6	(Feb-78)
1-0130-13,14	(Feb-78)	3-0360-15,16	(May-79)	3-0399-7,8	(Feb-78)
1-0130-15,16	(Feb-78)	3-0360-17,18	(Feb-78)	3-0399-9,10	(Feb-78)
1-0130-17,18	(Feb-78)	3-0360-19,20	(May-79)	3-0399-11,12	(Feb-78)
1-0130-19,20	(Feb-78)	3-0360-21,22	(Feb-78)	3-0399-13,14	(Feb-78)
1-0130-21,22	(Feb-78)	3-0360-23,24	(Feb-78)	3-0399-15,16	(Feb-78)

I Vertical lines indicate pages included in this revision.

* Remove these pages from manual.

3-0399-17,18	(Feb-78)	4-0419-1,2	(May-79)	8-0851-5,6	(May-79)
3-0399-19,20	(May-79)	4-0420-1,2	(May-79)	8-0851-7,8	(May-79)
3-0399-21,22	(Feb-78)	4-0421-1,2	(May-79)	8-0899-1,2	(May-79)
4-0400-1,2	(May-79)	4-0421-3,4	(May-79)	11-1111-1,2	(Feb-78)
4-0400-3,4	(May-79)	4-0422-1,2	(May-79)	11-1111-3,4	(Feb-78)
4-0400-5,6	(May-79)	4-0422-3,4	(May-79)	11-1111-5,6	(Feb-78)
4-0400-7,8	(May-79)	4-0422-5,6	(May-79)	11-1115-1,2	(Feb-78)
4-0400-9,10*	(Feb-78)	4-0422-7,8	(May-79)	11-1115-1,2	(Feb-78)
4-0401-1,2	(May-79)	4-0422-9,10	(May-79)	11-1160-1,2	(Feb-78)
4-0401-3,4	(May-79)	4-0422-9,10	(May-79)	11-1160-3,4	(Feb-78)
4-0401-5,6	(May-79)	4-0423,1,2	(May-79)	11-1199-1,2	(Feb-78)
4-0401-7,8	(May-79)	4-0429-1,2	(May-79)	15-1511-1,2	(Feb-78)
4-0402-1,2	(May-79)	4-0433-1,2	(May-79)	15-1511-3,4	(Feb-78)
4-0402-3,4	(May-79)	4-0499-1,2	(May-79)	15-1512-1,2	(Feb-78)
4-0402-5,6	(May-79)	4-0499-3,4	(May-79)	16-1671-1,2	(Feb-78)
4-0403-1,2	(May-79)	4-0499-5,6	(May-79)	16-1671-3,4	(Feb-78)
4-0403-3,4	(May-79)	4-0499-7,8	(May-79)	16-1671-5,6	(May-79)
4-0403-5,6	(May-79)	4-0499-9,10	(May-79)	16-1671-7,8	(Feb-78)
4-0403-7,8	(May-79)	4-0499-11,12	(May-79)	16-1672-1,2	(Feb-78)
4-0404-1,2	(May-79)	4-0499-13,14	(May-79)	16-1672-3,4	(Feb-78)
4-0404-3,4	(May-79)	4-0499-15,16	(May-79)	16-1672-5,6	(Feb-78)
4-0404-5,6	(May-79)	4-0499-17,18	(May-79)	16-1672-7,8	(Feb-78)
4-0404-7,8	(May-79)	4-0499-19,20	(May-79)	16-1672-9,10	(Feb-78)
4-0404-9,10	(May-79)	4-0499-21,22	(May-79)	16-1672-11,12	(Feb-78)
4-0407-1,2	(May-79)	4-0499-23,24	(May-79)	16-1672-13,14	(Feb-78)
4-0407-3,4	(May-79)	4-0499-25,26	(May-79)	16-1672-15,16	(Feb-78)
4-0408-1,2	(May-79)	4-0499-27,28	(May-79)	16-1672-17,18	(Feb-78)
4-0409-1,2	(May-79)	4-0499-29,30	(May-79)	16-1672-19,20	(Feb-78)
4-0409-3,4	(May-79)	4-0499-31,32	(May-79)	16-1672-21,22	(Feb-78)
4-0409-5,6	(May-79)	4-0499-33,34	(May-79)	16-1672-23,24	(Feb-78)
4-0410-1,2	(May-79)	4-0499-35,36	(May-79)	16-1672-25,26	(Feb-78)
4-0413-1,2	(May-79)	4-0499-37,38	(May-79)	16-1673-1,2	(Feb-78)
4-0413-3,4	(May-79)	4-0499-39,40	(May-79)	16-1674-1,2	(Feb-78)
4-0413-5,6	(May-79)	4-0499-41,42*	(Feb-78)*	16-1674-3,4	(Feb-78)
4-0413-7,8	(May-79)	5-0505-1,2	(Feb-78)	16-1674-5,6	(Feb-78)
4-0413-9,10	(May-79)	5-0505-3,4	(Feb-78)	16-1676-1,2	(Feb-78)
4-0413-11,12	(May-79)	5-0505-5,6	(Feb-78)	16-1676-3,4	(May-79)
4-0413-13,14	(May-79)	5-0510-1,2	(Feb-78)	16-1676-5,6	(May-79)
4-0413-15,16	(May-79)	5-0510-3,4	(May-79)	16-1699-1,2	(Feb-78)
4-0413-17,18	(May-79)	5-0515-1,2	(Feb-78)	16-1699-3,4	(Feb-78)
4-0413-19,20	(May-79)	5-0515-3,4	(Feb-78)	16-1699-5,6	(Feb-78)
4-0414-1,2	(May-79)	5-0515-5,6	(Feb-78)	16-1699-7,8	(May-79)
4-0415-1,2*	(Feb-78)	5-0520-1,2	(Feb-78)	16-1699-9,10	(Feb-78)
4-0416-1,2	(May-79)	5-0530-1,2	(May-79)	17-1740-1,2	(Feb-78)
4-0416-3,4	(May-79)	5-0540-1,2	(Feb-78)	17-1740-3,4	(Feb-78)
4-0416-5,6	(May-79)	5-0560-1,2	(Feb-78)	17-1740-5,6	(May-79)
4-0416-7,8	(May-79)	5-0599-1,2	(May-79)	17-1746-1,2	(Feb-78)
4-0417-1,2	(May-79)	8-0841-1,2	(May-79)	17-1799-1,2	(May-79)
4-0417-3,4	(May-79)	8-0841-3,4	(May-79)		
4-0417-5,6	(May-79)	8-0851-1,2	(Feb-78)		
4-0418-1,2	(May-79)	8-0851-3,4	(Feb-78)		

I Vertical lines indicate pages included in this revision.

* Remove pages from manual.

18-1810-1,2	(May-79)	32-3260-13,14	(May-79)	90-9025-5,6	(May-79)
18-1810-3,4	(Feb-78)	32-3260-15,16	(May-79)	90-9025-7,8	(May-79)
18-1810-5,6	(Feb-78)	32-3260-17,18	(May-79)	90-9025-9,10	(Feb-78)
18-1810-7,8	(May-79)	32-3260-19,20	(May-79)	90-9025-11,12	(May-79)
18-1810-9,10	(Feb-78)	32-3260-21,22	(May-79)	90-9025-13,14	(May-79)
18-1810-11,12	(Feb-78)	32-3299-1,2	(May-79)	90-9025-15,16	(May-79)
18-1821-1,2	(Feb-78)	32-3299-3,4	(May-79)	90-9025-17,18	(May-79)
18-1821-3,4	(Feb-78)	32-3299-5,6	(May-79)	90-9025-19,20	(May-79)
18-1821-5,6	(Feb-78)			90-9025-21,22	(Feb-78)
18-1830-1,2	(Feb-78)	40-4041-1,2	(Feb-78)	90-9025-23,24	(Feb-78)
18-1830-3,4	(May-79)	40-4041-3,4	(Feb-78)	90-9025-25,26	(May-79)
18-1830-5,6	(Feb-78)			90-9025-27,28	(Feb-78)
18-1830-7,8	(Feb-78)	42-4215-1,2	(Feb-78)	90-9025A-1,2	(Feb-78)
18-1830-9,10	(Feb-78)	42-4215-3,4	(May-79)	90-9025A-3,4	(Feb-78)
18-1830-11,12	(Feb-78)	42-4215-5,6	(Feb-78)	90-9025A-5,6	(Feb-78)
18-1830-13,14	(Feb-78)	42-4260-1,2	(Feb-78)	90-9025A-7,8	(May-79)
18-1830-15,16	(Feb-78)	42-4260-3,4	(May-79)	90-9025A-9,10	(May-79)
18-1830-17,18	(May-79)			90-9025A-11,12	(Feb-78)
18-1830-19,20	(May-79)	90-9005-1,2	(May-79)	90-9026-1,2	(May-79)
18-1830-21,22	(May-79)	90-9005-3,4	(Feb-78)	90-9026-3,4	(Feb-78)
18-1830-23,24	(May-79)	90-9010-1,2	(Feb-78)	90-9026-5,6	(Feb-78)
18-1830-25,26	(May-79)	90-9010-3,4	(Feb-78)	90-9026-7,8	(Feb-78)
18-1830-27,28	(May-79)	90-9010-5,6	(Feb-78)	90-9026-9,10	(Feb-78)
18-1830-29,30	(May-79)	90-9010-7,8	(Feb-78)	90-9026-11,12	(Feb-78)
18-1830-31,32	(May-79)	90-9010-9,10	(Feb-78)	90-9026-13,14	(Feb-78)
18-1899-1,2	(May-79)	90-9010-11,12	(May-79)	90-9026-15,16	(May-79)
18-1899-3,4	(May-79)	90-9010-13,14	(May-79)	90-9026-17,18	(Feb-78)
19-1910-1,2	(Feb-78)	90-9010-15,16	(May-79)	90-9026-19,20	(May-79)
19-1910-3,4	(Feb-78)	90-9015-1,2	(Feb-78)	90-9026-21,22	(Feb-78)
19-1910-5,6	(Feb-78)	90-9015-3,4	(Feb-78)	90-9026-23,24	(Feb-78)
19-1921-1,2	(May-79)	90-9015-5,6	(Feb-78)	90-9026-25,26	(Feb-78)
19-1927-1,2	(Feb-78)	90-9015-7,8	(Feb-78)	90-9026-27,28	(Feb-78)
		90-9015-9,10	(Feb-78)	90-9026-29,30	(Feb-78)
20-2003-1,2	(Feb-78)	90-9015-11,12	(Feb-78)	90-9026-31,32	(Feb-78)
20-2003-3,4	(Feb-78)	90-9015-13,14	(Feb-78)	90-9026-33,34	(Feb-78)
20-2004-1,2	(Feb-78)	90-9015-15,16	(Feb-78)	90-9026-35,36	(Feb-78)
20-2006-1,2	(Feb-78)	90-9015-17,18	(Feb-78)	90-9026-37,38	(Feb-78)
		90-9015-19,20	(Feb-78)	90-9026-39,40	(Feb-78)
32-3201-1,2	(Feb-78)	90-9015-21,22	(Feb-78)	90-9026-41,42	(Feb-78)
32-3201-3,4	(May-79)	90-9015-23,24	(Feb-78)	90-9026-43,44	(May-79)
32-3201-5,6	(Feb-78)	90-9015-25,26	(Feb-78)	90-9026-45,46	(Feb-78)
32-3215-1,2	(May-79)	90-9015-27,28	(Feb-78)	90-9026-47,48	(Feb-78)
32-3240-1,2	(Feb-78)	90-9015-29,30	(Feb-78)	90-9026-49,50	(May-79)
32-3240-3,4	(Feb-78)	90-9015-31,32	(Feb-78)	90-9026-51,52	(Feb-78)
32-3240-5,6	(Feb-78)	90-9020-1,2	(Feb-78)	90-9026-53,54	(May-79)
32-3260-1,2	(Feb-78)	90-9020-3,4	(Feb-78)	90-9026-55,56	(May-79)
32-3260-3,4	(Feb-78)	90-9020-5,6	(Feb-78)	90-9026-57,58	(May-79)
32-3260-5,6	(Feb-78)	90-9020-7,8	(Feb-78)	90-9026-59,60	(Feb-78)
32-3260-7,8	(Feb-78)	90-9020-9,10	(Feb-78)	90-9026-61,62	(Feb-78)
32-3260-9,10	(Feb-78)	90-9020-11,12	(Feb-78)	90-9026-63,64	(May-79)
32-3260-11,12	(May-79)	90-9025-1,2	(Feb-78)	90-9026-65,66	(Feb-78)
		90-9025-3,4	(Feb-78)	90-9026-67,68	(Feb-78)

| Vertical lines indicate pages included in this revision.

90-9026-69,70	(Feb-78)	90-9026-115,116	(May-79)	90-9030-3,4	(Feb-78)
90-9026-71,72	(Feb-78)	90-9026-117,118	(May-79)	90-9031-1,2	(May-79)
90-9026-73,74	(Feb-78)	90-9026-119,120	(May-79)	90-9031-3,4	(Feb-78)
90-9026-75,76	(May-79)	90-9026-121,122	(May-79)	90-9031-5,6	(Feb-78)
90-9026-77,78	(May-79)	90-9026-123,124	(May-79)	90-9031-7,8	(May-79)
90-9026-79,80	(May-79)	90-9026-125,126	(May-79)	90-9031-9,10	(May-79)
90-9026-81,82	(Feb-78)	90-9026-127,128	(May-79)	90-9031-11,12	(May-79)
90-9026-83,84	(May-79)	90-9026-129,130	(May-79)	90-9031-13,14	(May-79)
90-9026-85,86	(May-79)	90-9026-131,132	(May-79)	90-9031-15,16	(Feb-78)
90-9026-87,88	(Feb-78)	90-9026-133,134	(May-79)	90-9031-17,18	(Feb-78)
90-9026-89,90	(May-79)	90-9026-135,136	(May-79)	90-9031-19,20	(May-79)
90-9026-91,92	(Feb-78)	90-9026-137,138	(May-79)	90-9035-1,2	(Feb-78)
90-9026-93,94	(Feb-78)	90-9026-139,140	(May-79)	90-9035-3,4	(Feb-78)
90-9026-95,96	(May-79)	90-9026-141,142	(May-79)	90-9035-5,6	(May-79)
90-9026-97,98	(May-79)	90-9026-143,144	(May-79)	90-9035-7,8	(Feb-78)
90-9026-99,100	(Feb-78)	90-9026-145,146	(May-79)	90-9035-9,10	(Feb-78)
90-9026-101,102	(Feb-78)	90-9026-147,148	(May-79)	90-9035-11,12	(Feb-78)
90-9026-103,104	(Feb-78)	90-9026-149,150	(May-79)	90-9035-13,14	(May-79)
90-9026-105,106	(Feb-78)	90-9026-151,152	(May-79)	90-9035-15,16	(May-79)
90-9026-107,108	(May-79)	90-9026-153,154	(May-79)	90-9035-17,18	(May-79)
90-9026-109,110	(May-79)	90-9026-155,156	(May-79)	90-9035-19,20	(May-79)
90-9026-111,112	(May-79)	90-9030-1,2	(Feb-78)	90-9035-21,22	(May-79)
90-9026-113,114	(May-79)				

I Vertical lines indicate pages included in this revision.

Group II INTRODUCTION AND SAFETY INFORMATION INTRODUCTION



Use FOS Manuals for Reference

This technical manual is part of a twin concept of service:

The two kinds of manuals work as a team to give you both the general background and technical details of shop service.

•FOS Manuals—for reference

Fundamentals of Service (FOS) Manuals cover basic theory of operation, *fundamentals* of trouble shooting, *general* maintenance, and *basic* types of failures and their causes. FOS Manuals are for training new personnel and for reference by experienced service technicians.



When a service technician should refer to a FOS Manual for more information, a FOS symbol like the one at the left is used in the TM to identify the reference.

•Technical Manuals—for actual service

Technical Manuals are concise service guides for a *specific* machine. Technical manuals are on-the-job guides containing only the vital information needed by an experienced service technician.

Litho in U.S.A.

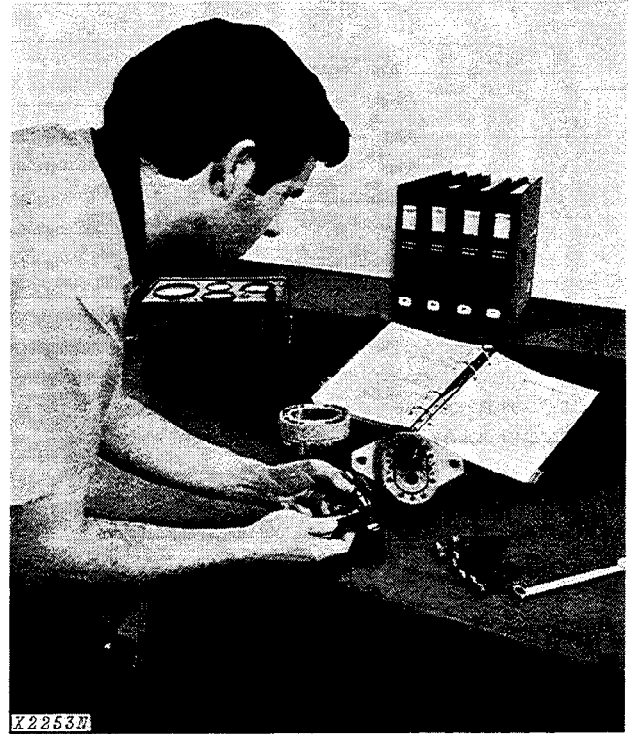

Use Technical Manuals for Actual Service

This technical manual was planned and written for you—an experienced service technician. Keep it in a permanent binder in the shop where it is handy. Refer to it whenever in doubt about correct service procedures or specifications.

Some features of this manual:

- Inside front cover - "Table of Contents".
- Section 1 - Contents, safety information, general specifications and general services.
- Sections 1 through 42 - Removal, repair, testing (components removed), installation, and adjustment.
- Section 90 - Detailed explanation of system operation, diagnosis, visual inspection, testing, and adjustments.
- Specifications grouped and illustrated at the end of each section.

MAINTENANCE WITHOUT ACCIDENT WORK SAFELY



T27999N

 This safety alert symbol is used for important safety messages. When you see this symbol, the possibility of personal injury exists if safety message is not followed.

**EVERY EMPLOYER HAS A
SAFETY PROGRAM. KNOW
WHAT IT IS!**



T27501N

Consult your shop supervisor for specific instructions on a job, and the safety equipment required.

For instance, you may need: Hard hat, safety shoes, safety goggles, heavy gloves, reflector vests, ear protectors, respirators.

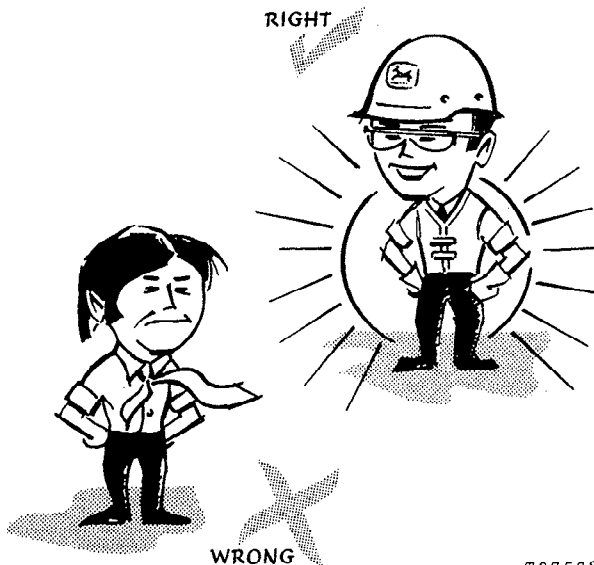

T27502N

ALWAYS AVOID loose clothing or any accessory—flopping cuffs, dangling neckties and scarves, or rings and wrist watches—that can catch in moving parts and put you out of work.

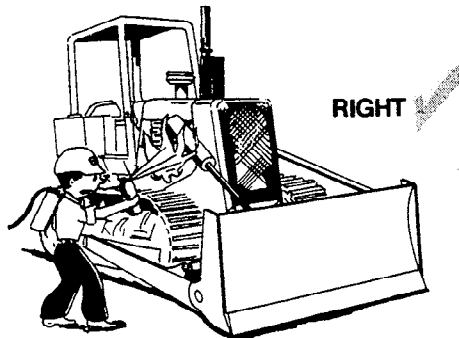

T56994N

BE ALERT!

Plan ahead — work safely — avoid accidental damage and injury. If a careless moment does cause an accident or fire, react quickly with the tools and skills at hand — know how to use a first aid kit and a fire extinguisher — and where to get aid and assistance. In an emergency, split-second action is the key to safety.

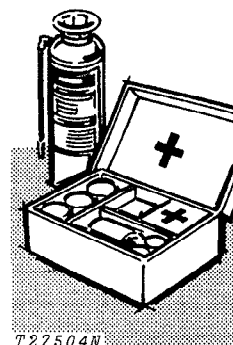

T27504N

MAINTENANCE WITHOUT ACCIDENT

Specific safety procedures should always be observed, whether servicing or making repairs on the crawler. Remembering these—in time!—can prevent an injury...or save your life...

AVOID FIRE HAZARDS—

Fuel Is Dangerous!

- Don't smoke while refueling.
- Don't smoke while handling highly flammable material.
- Engine should be shut off when refueling.
- Use care in refueling if the engine is hot.

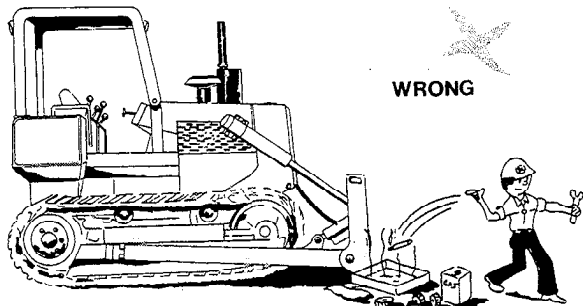

T56995N

Don't use open pans of gasoline or diesel fuel for cleaning parts. Good commercial, nonflammable solvents are preferred.

Battery Gas Is Highly Flammable!

Provide adequate ventilation when charging batteries.



T27508N

- Don't check battery charge by placing metal objects across the posts.
- Don't allow sparks or open flame near batteries.
- Don't smoke near battery.

Flame Is Not a Flashlight!

- Never check fuel, battery electrolyte or coolant levels with an open flame.
- Never use an open flame to look for leaks anywhere on the equipment.

Never use an open flame as a light anywhere on or around the equipment.

KNOW WHERE FIRE EXTINGUISHERS ARE KEPT!

UNDER ALL MAINTENANCE CONDITIONS—

Do not perform any work on the crawler unless authorized to do so. Then be sure you understand the services required. Follow recommended procedures.

Never service the equipment while it is being operated.

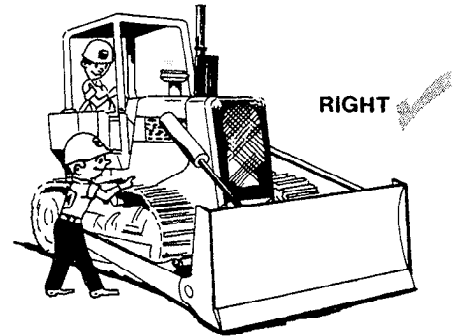

T56996N

Avoid working on equipment with the engine running. If it is necessary to make checks with the engine running, **ALWAYS USE TWO SERVICE TECHNICIANS**—one, the operator, at the controls, the other checking in view of the operator. Also, put the forward-reverse speed control lever in neutral, set the park brake, and apply any safety locks provided. **KEEP HANDS AWAY FROM MOVING PARTS.**

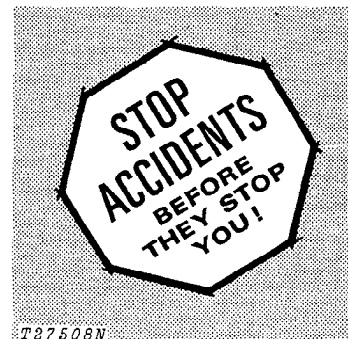

T27508N

MAINTENANCE WITHOUT ACCIDENT

Before servicing, adjusting, or repairing crawlers which have attachments such as blades, etc—**LOWER** attachments to the ground—or, if necessary to raise them for access to certain parts, **SECURELY SUPPORT** by external means. **DO NOT** rely on controls to support or position attachments for maintenance.

Never allow **ANYONE** to walk under equipment that is raised and not properly blocked.

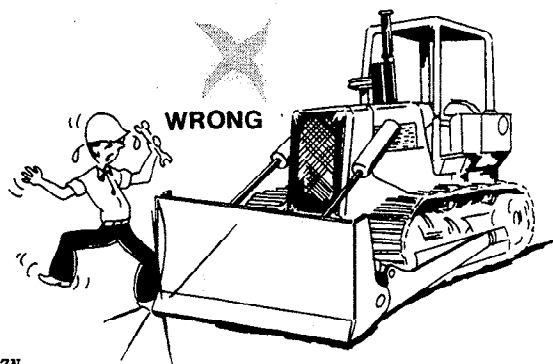

T56997N

Avoid working directly under raised and blocked equipment unless absolutely necessary.

If the crawler is on an incline, block it securely.

Use hoisting equipment for lifting heavy parts. **TAKE CARE! WATCH OUT FOR OTHER PEOPLE IN THE VICINITY.**

Use extreme caution in removing radiator caps, drain plugs, grease fittings, or hydraulic pressure caps.

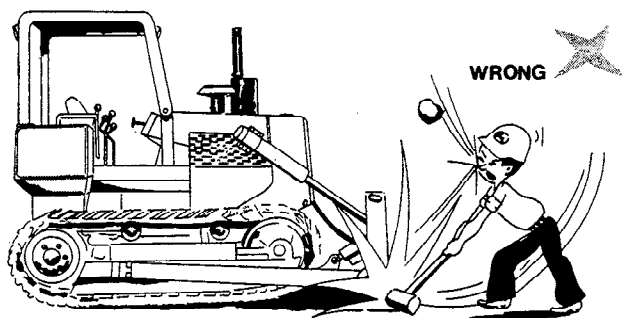

T56998N

Wear safety glasses when drilling, grinding, or hammering metal.

Make sure the maintenance area is adequately vented.

Keep maintenance area **CLEAN AND DRY**. Oily and wet floors are slippery; greasy rags are a fire hazard; wet spots are dangerous when working with electrical equipment.

Store starting aids in a cool and well-ventilated place, out of the reach of unauthorized personnel.

SERVICING PRECAUTIONS

Stop the engine before cleaning or lubricating the crawler.

Lower blade and ripper to the ground *carefully*.

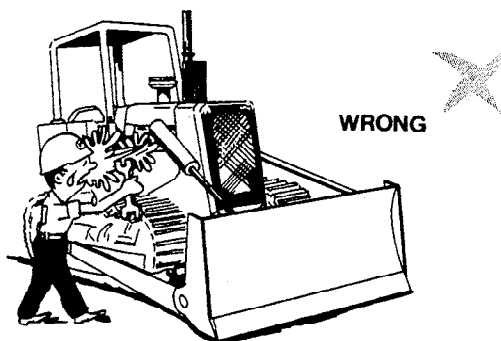

T56999N

Engine coolant gets hot! Don't remove the radiator cap until coolant temperature is below the boiling point. Then turn cap slightly to relieve pressure before removing.

Exhaust gases are dangerous! Periodically check exhaust system for excessive leakage.

Don't forget a hydraulic system may be pressurized! To relieve system pressure, stop engine, lower blade and ripper and operate blade and ripper control levers until system fails to respond.

When checking hydraulic pressure, be sure to use the correct test gauge for the pressure in the particular system.

MAINTENANCE WITHOUT ACCIDENT

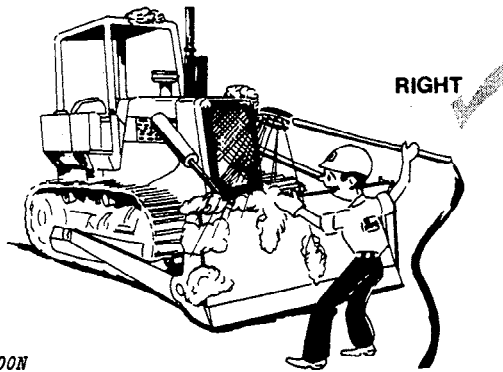

T57000N

Keep ALL components free of dirt and oil. This attention will minimize fire hazards and facilitate spotting of loose or defective parts.

When preparing engine for storage, remember that inhibitor is volatile and therefore dangerous. Seal and tape openings after adding the inhibitor. Keep container tightly closed when not in use.

ADJUSTING PRECAUTIONS

... for Operating Adjustments

Before making adjustments, stop engine.

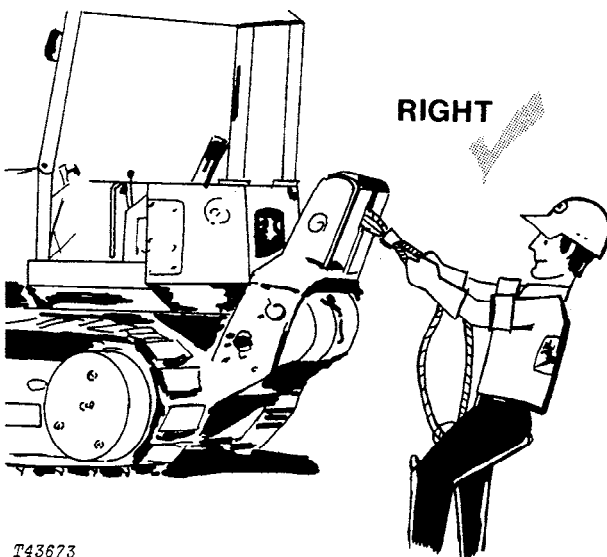

T43673

Always wear gloves when handling cable.



T67066N

Before removing any housing covers, stop engine. Take all objects from your pockets which could fall into the opened housings. Don't let adjusting wrenches fall into opened housings.

... for Maintenance Adjustments

Don't attempt to check belt tension while the engine is running.

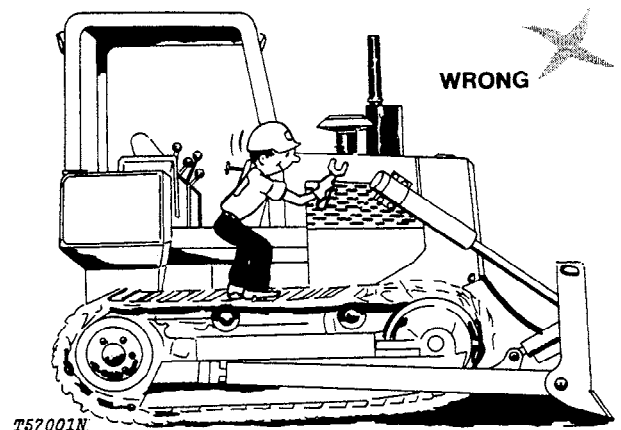

T57001N

Don't adjust the fuel system while the machine is in motion.

MAINTENANCE WITHOUT ACCIDENT

PRECAUTIONS DURING REPAIR

Before working on the engine fuel system—close fuel shutoff valve.

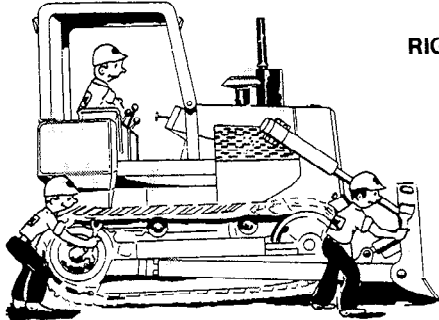

T57002N

Before repairing the electrical system, or performing a major overhaul, make sure the batteries are disconnected.

Stop the engine and securely block the blade.

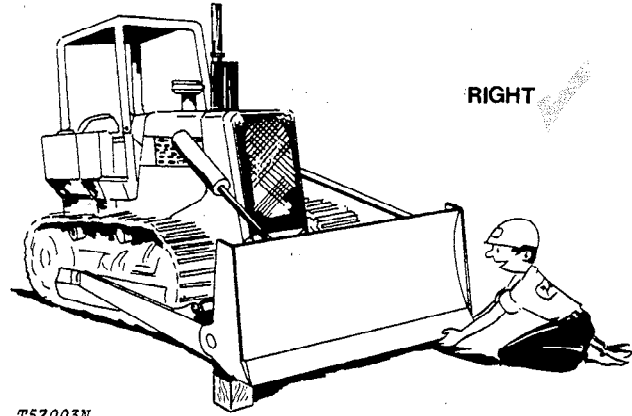

T57003N

Never let your bare hands come in contact with sharp edges. WEAR GLOVES.

MAINTENANCE WITHOUT ACCIDENT

KNOW EQUIPMENT IS READY!

Check guards, ROPS, safety bars—all protective devices installed on the crawler. Every one should be in place and secure.

CHECK IT OUT!

- GUARDS
- SHIELDS
- PROTECTIVE DEVICES
- ROLL-OVER PROTECTIVE STRUCTURES
- SEAT BELTS
- FIRE EXTINGUISHER, ETC.

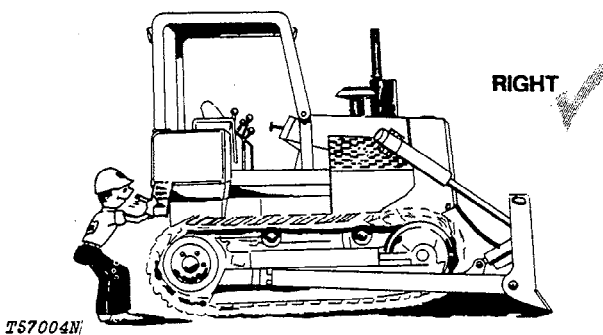

Carefully inspect equipment for visual defects—leaks in fuel, lubrication, and hydraulic systems. Do not search for pressurized fluid leaks with your hands. Use cardboard or wood to search for leaks.

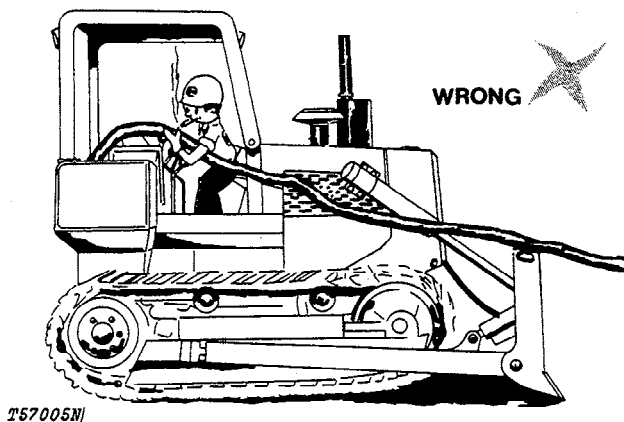

Check levels of fuel, coolant, hydraulic fluid, and lubricating oil. If fuel must be added—**FIRST, PUT OUT THAT CIGARET.**

Check and secure all caps and filler plugs for fuel, oils, radiator, etc.

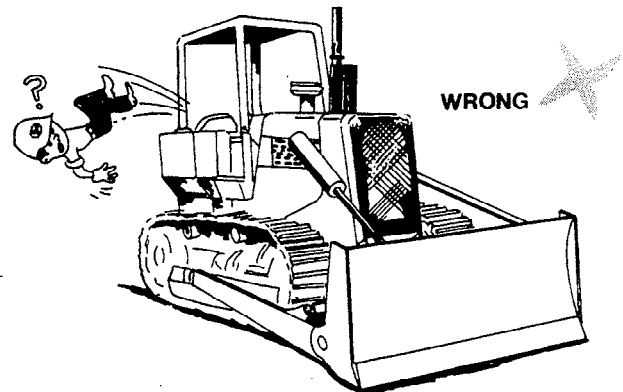

Be sure to clean any oil, grease or mud accumulation from floor of operator's compartment, stepping points, and grab rails to minimize the danger of slipping.

In freezing weather beware of snow or ice deposits on stepping points, grab rails, and floor.

Remove loose bolts, tools, or other objects from floor of operator's compartment.

Although it is impractical to try to cover every possible maintenance situation, the safety precautions recommended here should serve to develop and promote safe maintenance procedures.

The information contained in this manual is not intended to replace safety codes, insurance requirements, federal, state, and local laws, rules and regulations. In particular, your service area or jobsite activities may be subject to state safety rules and/or federal regulation under the Occupational Safety and Health Act (OSHA). Familiarize yourself with all regulations applicable to your situation in order to avoid possible safety violations.

Illustrations and copy reproduced in part by permission of Construction Industry Manufacturers' Association (CIMA).

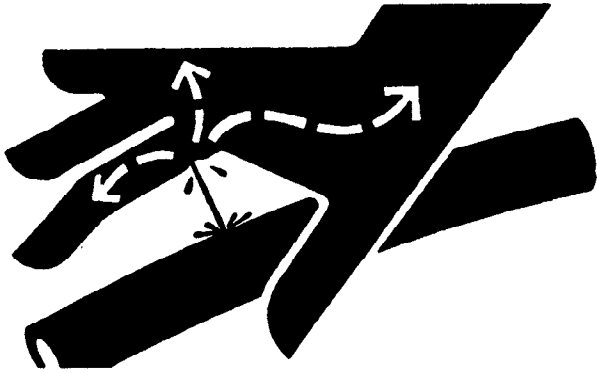

Escaping fluid under pressure can penetrate the skin causing serious injury. Relieve pressure before disconnecting hydraulic or other lines. Tighten all connections before applying pressure. Keep hands and body away from pinholes and nozzles which eject fluids under high pressure. Use a piece of cardboard or paper to search for leaks. Do not use your hand.

If ANY fluid is injected into the skin, it must be surgically removed within a few hours by a doctor familiar with this type injury or gangrene may result.

High pressure may be present in track cylinder. If grease does not immediately escape from vent hole, drive crawler forward and backward slowly, then tighten check valve.

Use extreme care when servicing area of track adjuster and recoil spring. Do not attempt to disassemble without proper tools and knowledge of disassembly procedure.

If ROLL-GARD® protective frame or ROLL-OVER protective equipment is loosened or removed for any reason, make certain all parts are reinstalled correctly. Tighten mounting bolts to proper torque. The protection offered by ROPS will be impaired if the ROPS is subject to structural damage, has been involved in an overturn incident or is in anyway altered. Damaged ROPS should be replaced, not reused.

Prevent Fires Before Starting Engine

Check the fire extinguisher for correct charge.

Open both side shields and grille and remove trash.

Remove trash from bottom guards, drive lines, batteries, hydraulic lines, fuel tank and operator's station.

Check for leaking fuel lines, hydraulic lines, hoses, or fittings with a piece of cardboard or wood. Do not use your hands. Tighten loose fittings. If lines are bent or hoses kinked, install new parts.

Prevent Fires After Stopping Engine

Temperature in engine compartment may go up immediately after you stop the engine. **BE ON GUARD FOR FIRES.**

Before you clean trash from the engine compartment, wait until the engine has cooled. Open side shields to cool the engine faster. While the engine cools, clean trash from other areas.

Avoid possible injury or death from machinery runaway.

Do not start engine by shorting across starter terminals. Machine will start in gear and will move if normal circuitry is bypassed.

NEVER start engine while standing on ground. Start engine only from operator's seat, with forward and reverse control lever in neutral, neutral lock lever in locked position and park brake applied.

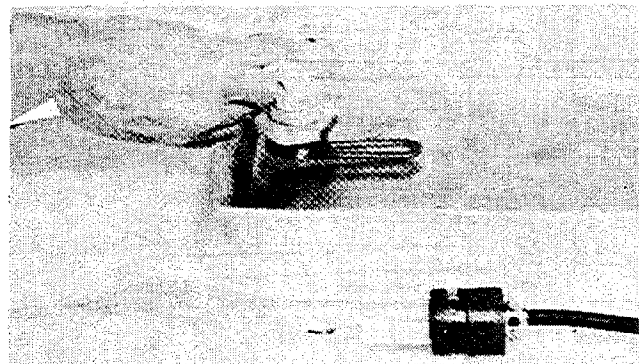

Use a heavy-duty grounded cord to connect coolant heater to electrical power.

Do not plug into electrical power unless heating element is immersed in coolant. Sheath could burst and result in personal injury.

Group III GENERAL SPECIFICATIONS

Specifications and design subject to change without notice. Wherever applicable, specifications are in accordance with ICED, and SAE Standards. Except where otherwise noted, these specifications are based on a unit equipped with roll-over protective canopy, 20 in. (508 mm) grousers, full fuel tank, 175 lb (79 kg) operator, and standard equipment.

Power (@ 1800 rpm):	SAE	
Gross	165 hp (123 kW*)	
Net	145 hp (108 kW*)	147 PS

Net engine flywheel power is for an engine equipped with fan, air cleaner, water pump, lubricating oil pump, fuel pump, alternator and muffler. The gross engine power is without fan. Flywheel power ratings are under SAE standard conditions of 500 ft. (150 m) altitude and 85°F (29°C) temperature, and DIN 6270 conditions (non-corrected). No derating is required up to 10,000 feet (3 000 m) altitude.

* In the international System of units (SI), power is expressed in kilowatts (kW).

Engine:

John Deere turbocharged diesel, 6-cylinder, 4-stroke cycle.

Bore and stroke	5.12 x 5 in. (130 x 127 mm)
Piston displacement	619 cu. in. (10 144 cm ³)
Compression ratio	15.2 to 1
Maximum torque @ 1200 rpm	550 lb-ft (746 N·m) (76.1 kg/m)
NACC or AMA (U.S. Tax) horsepower	62.9
Lubrication	Pressure sytem with full flow filters
Main bearings	7
Cooling	Pressurized with thermostat and controlled bypass
Fan	Blower
Air cleaner with restriction indicator	Dry
Electrical system	24 volt with alternator
Batteries, two-12 volt	Reserve capacity: 180 minutes each

Transmission:

Cold weather starting . . . disconnect clutch completely disengages splitter drive, hydrostatic drive and all hydraulics.

Splitter drive . . . Pressure-lubricated helical gears drive both hydrostatic transmissions, main hydraulic pump, winch drive shaft and auxiliary pump drive.

Drive . . . Dual-path, full automatic, infinitely variable hydrostatic transmissions.

Speeds . . Infinite form 0 to 6.5 mph (0 to 10.5 km/h) forward or reverse.

Control . . . Single-lever, variable speed, forward and reverse.

Drawbar pull:

Maximum drawbar pull

65,000 lb.
(291 kN) (29 484 kg)
at 0.20 mph
(0.33 km/h)

Steering:

Fully modulated infinitely variable lever steering for live power turns and counter rotation. Pedal steering optional. No need for steering clutches or steering brakes.

Brakes:

Service

Hydrostatic

Parking Wet-disk brakes are automatically applied when engine is stopped, or manually applied with center pedal during normal operation.

850 GENERAL-PURPOSE CRAWLER

Hydraulic System: Open-center (optional)
 Control Single-lever, two-function control
 Pump Vane, 38 gpm (2.40 L/s) @ rated engine speed
 Pressure 2250 psi (15 514 kPa) (158.2 kg/cm²)

Tracks: 6-roller track frame w/front guide. DURA-TRAX™ deep-heat-treated sealed track links and through-hardened sealed rollers provide maximum wear resistance.

Grouser 20 in. (508 mm)
 Track shoes, each side 37
 Grounded contact area 3800 sq. in. (24 516 cm²)
 Ground pressure 8.58 psi (59.1 kPa) (0.60 kg/cm²)
 Length of track on ground 95 in. (2.41 m)
 Track gauge 74 in. (1.88 mm)
 Oscillation 10 in. (254 mm)
 Carrier rollers 2 each side
 Adjustment Hydraulic
 Minimum ground clearance 16.4 in. (417 mm)

Capacities:	U.S.	Liters
Cooling system	9 gal.	34.0
Fuel tank	82 gal.	310.4
Crankcase	32 qt.	30.3
Crankcase, including filter	34 qt.	32.2
Splitter drive	1.5 gal.	5.7
Final drive, each		
Inner compartment	5.5 gal.	20.8
Outer compartment	3.5 gal.	13.2
Hydraulic system (optional)	35 gal.	132.5
Hydrostatic drives	40 gal.	151.4

SAE Operating Weight w/ROPS 32,600 lb. (14 790 kg)

850/6540 ANGLED ODOZER

Hydraulic System: Open-center
 Control Single-lever, two function control
 Pump Vane, 38 gpm (2.40 L/s) @ rated engine speed
 Pressure 2250 psi (15 514 kPa) (158.2 kg/cm²)

Hydraulic Cylinders:	Bore	Stroke
Lift, two	4.25 in. (108 mm)	33.82 in. (859 mm)
Tilt, two	5.5 in. (140 mm)	4.33 in. (110 mm)
Cylinder rods	Ground, heat-treated, chrome-plated, polished	

Tracks: 6-roller track frame w/front and rear track guides and sprocket guard. DURA-TRAX™ deep-heat-treated sealed track links and through-hardened sealed rollers provide maximum wear resistance.

Grouser 20 in. (508 mm)
 Track shoes, each side 37
 Ground contact area 3800 sq. in. (24 516 cm²)
 Ground pressure 9.77 psi (67.4 kPa) (0.69 kg/cm²)
 Length of track on ground 95 in. (2.41 m)
 Track gauge 74 in. (1.88 mm)
 Oscillation 10 in. (254 mm)
 Carrier rollers 2 each side
 Adjustment Hydraulic
 Minimum ground clearance 16.4 in. (417 mm)

Blade:
 Cutting edge 3-piece
 Center section 0.75 in. (19 mm)
 End bits, boron steel 0.75 in. (19 mm)

Capacities:	U.S.	Liters
Cooling system	9 gal.	34.0
Fuel tank	82 gal.	310.4
Crankcase	32 qt.	30.3
Crankcase, including filter	34 qt.	32.2
Splitter drive	1.5 gal.	5.7
Final drive, each:		
Inner compartment	5.5 gal.	20.8
Outer compartment	3.5 gal.	13.2
Hydraulic system (optional)	35 gal.	132.5
Hydrostatic drives	40 gal.	151.4

SAE Operating Weight w/ROPS 37,120 lb. (16 840 kg)

850/6545 BULLDOZER

Hydraulic System: Open-center
 Control Single-lever, two function control
 Pump Vane, 38 gpm (2.40 L/s) @ rated engine speed
 Pressure 2250 psi (15 514 kPa) (158.2 kg/cm²)

Hydraulic Cylinders:	Bore	Stroke
Lift, two	4.25 in. (108 mm)	34.41 in. (874 mm)
Tilt, two	6.25 in. (159 mm)	4.41 in. (112 mm)
Cylinder rods	Ground, heat-treated, chrome-plated, polished	
Cylinder pivot pins	Hardened steel (replaceable bushings)	

Tracks: 6-roller track frame w/front and rear track guides and sprocket guard. DURA-TRAX™ deep-heat-treated sealed track links and through-hardened sealed rollers provide maximum wear resistance.

Grouser 20 in. (508 mm)
 Track shoes, each side 37
 Ground contact area 3800 sq. in. (24 516 cm²)
 Ground pressure 9.68 psi (66.7 kPa) (0.68 kg/cm²)
 Length of track on ground 95 in. (2.41 m)
 Track gauge 74 in. (1.88 mm)
 Oscillation 10 in. (254 mm)
 Carrier rollers 2 each side
 Adjustment Hydraulic
 Minimum ground clearance 16.4 in. (417 mm)

Blade:
 Cutting edge 3-piece
 Center section 0.75 in. (19 mm)
 End bits, boron steel 0.75 in. (19 mm)

Capacities:	U.S.	Liters
Cooling system	9 gal.	34.0
Fuel tank	82 gal.	310.4
Crankcase	32 qt.	30.3
Crankcase, including filter	34 qt.	32.2
Splitter drive	1.5 gal.	5.7
Final drive, each:		
Inner compartment	5.5 gal.	20.8
Outer compartment	3.5 gal.	13.2
Hydraulic system	35 gal.	132.5
Hydrostatic drives	40 gal.	151.4

SAE Operating Weight w/ROPS 36,785 lb. (16 690 kg)

850 LOW GROUND PRESSURE BULLDOZER

Hydraulic System: Open-center

Control Single-lever, two function control
 Pump Vane, 38 gpm (2.40 L/s) @ rated engine speed
 Pressure 2250 psi (15 514 kPa) (158.2 kg/cm²)

Hydraulic Cylinders:

	Bore	Stroke
Lift, two	4.25 in. (108 mm)	40.16 in. (1020 mm)
Tilt, two	6.25 in. (159 mm)	4.41 in. (112 mm)

Cylinder rods Ground, heat-treated, chrome-plated, polished

Tracks: 7-roller track frame w/front, center and rear track guides and sprocket guard. DURA-TRAX™ sealed chain, deep-hardened track links and rollers provide maximum wear resistance.

Shoe width 38 in. (965 mm)
 Track shoes, each side 43
 Ground contact area 9044 sq. in. (58 352 cm²)
 Ground pressure 4.86 psi (33.5 kPa) (0.34 kg/cm²)
 Length of track on ground 119 in. (3.02 m)
 Track gauge 88 in. (2.24 m)
 Oscillation (at front idler) 15.7 in. (399 mm)
 Carrier rollers 2 each side
 Adjustment Hydraulic
 Minimum ground clearance
 With single bar grouser (excluding
 grouser height) 16.0 in. (406 mm)
 With swamp shoe (including
 grouser height) 19.3 in. (490 mm)

Cutting Edge:

Center section, heat-treated boron
 steel, reversible 0.75 in. (19 mm)
 End bits, boron steel 0.75 in. (19 mm)

Capacities:	U.S.	Liters
Cooling system	9 gal.	34.0
Fuel tank	82 gal.	310.4
Crankcase	32 qt.	30.3
Crankcase, including full flow engine oil filter and engine oil bypass filter	36.5 qt.	34.5
Final drive, each: 1st reduction	10 gal.	37.9
2nd reduction	3.5 gal.	13.2
Hydraulic system	35 gal.	132.5
Hydrostatic drives	40 gal.	151.4
Splitter drive	1.5 gal.	5.7

SAE Operating Weight w/ROPS 44,000 lb. (19 960 kg)

850 GENERAL-PURPOSE CRAWLER DIMENSIONS

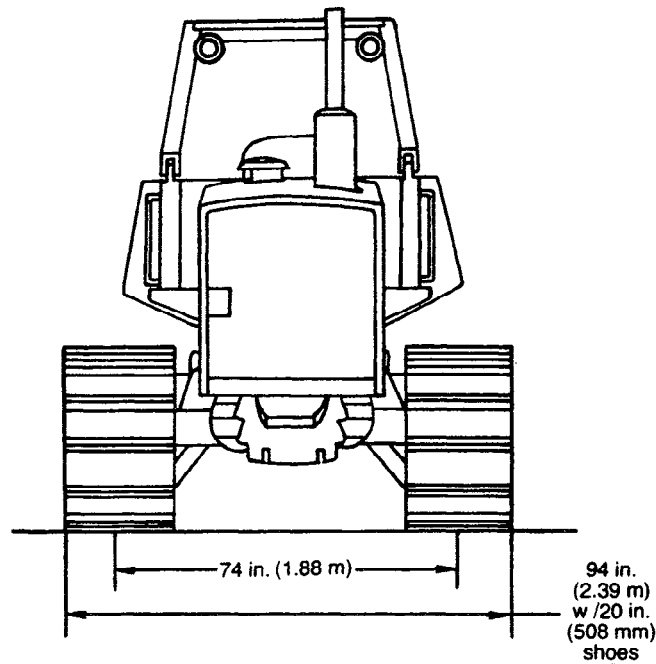
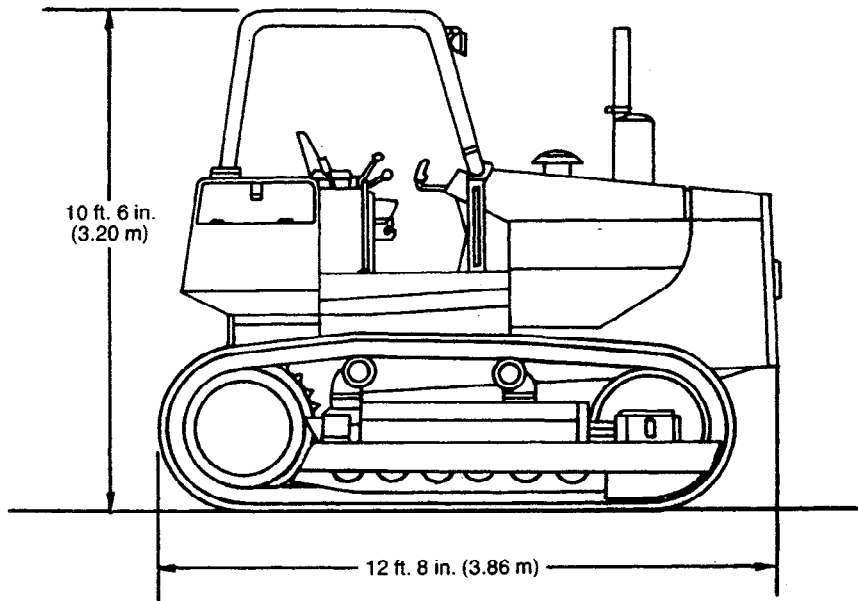

T94328

850/6540 ANGLEDOZER DIMENSIONS

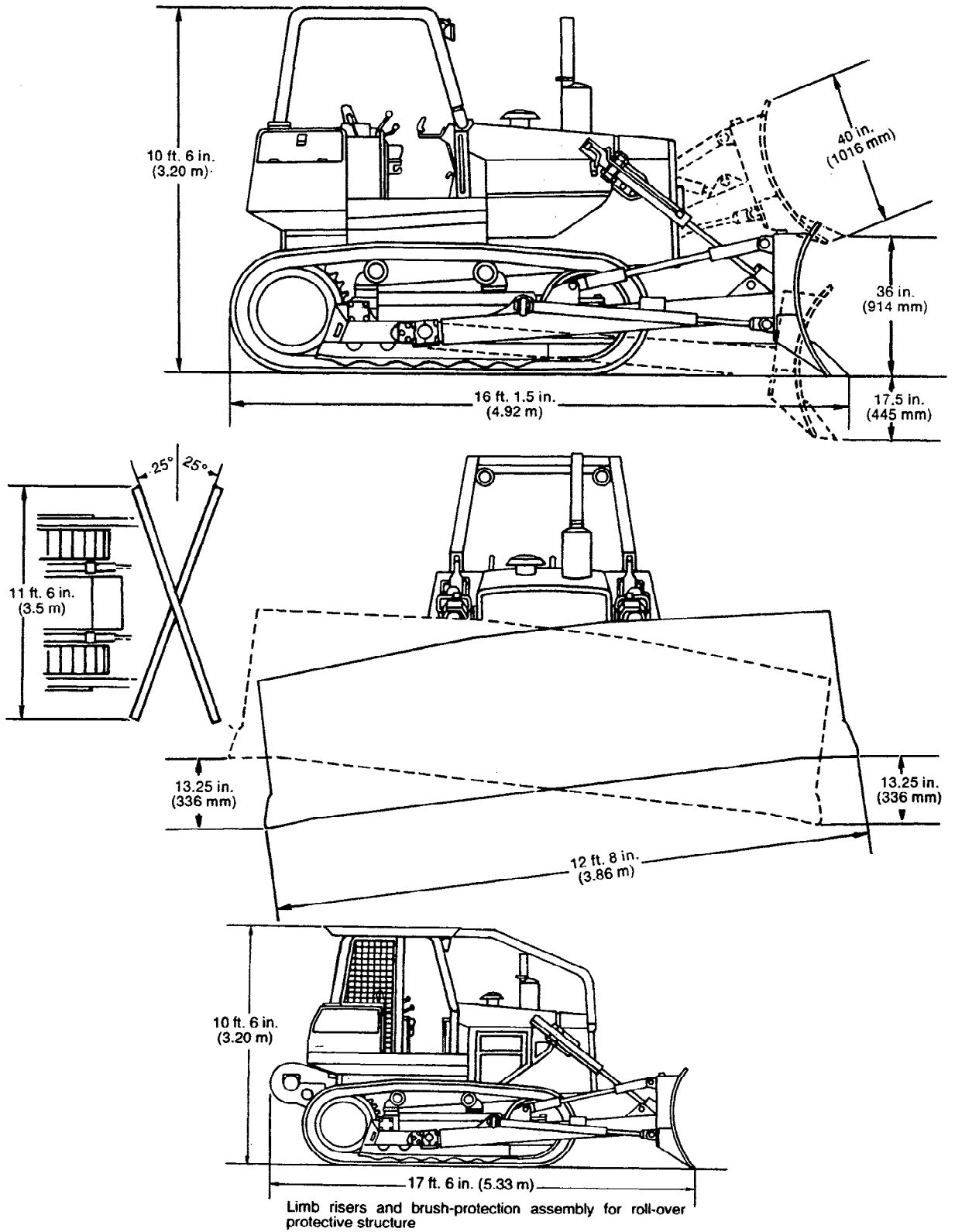

T94329

850/6545 BULLDOZER DIMENSIONS

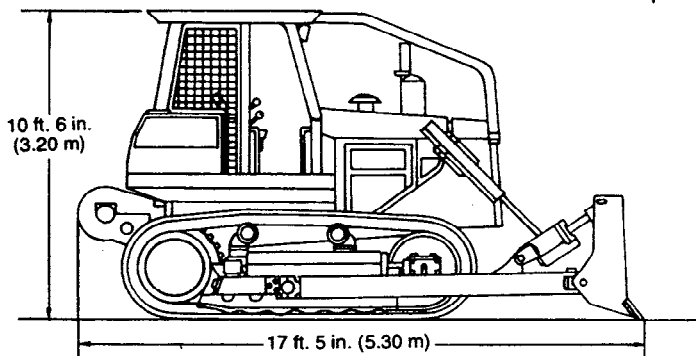
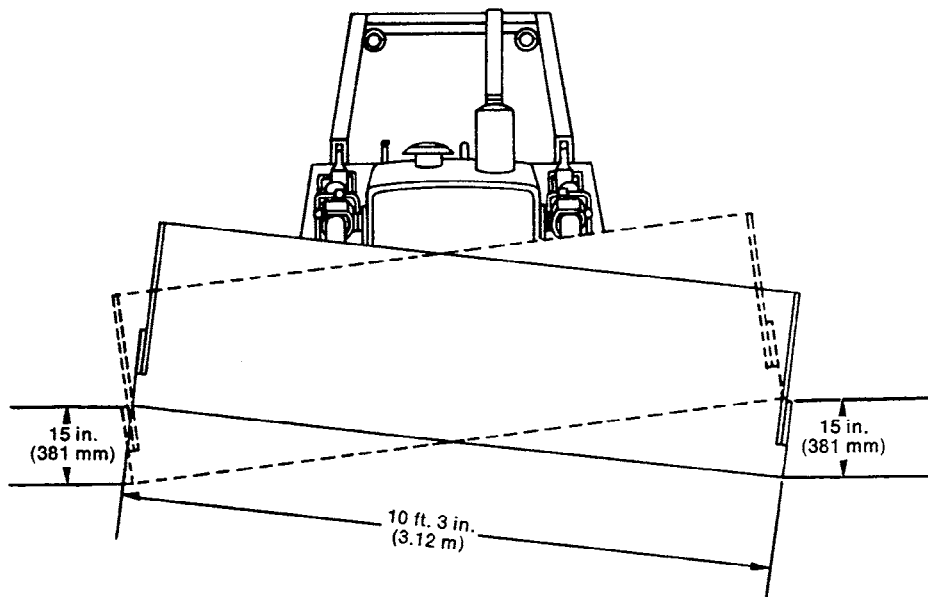
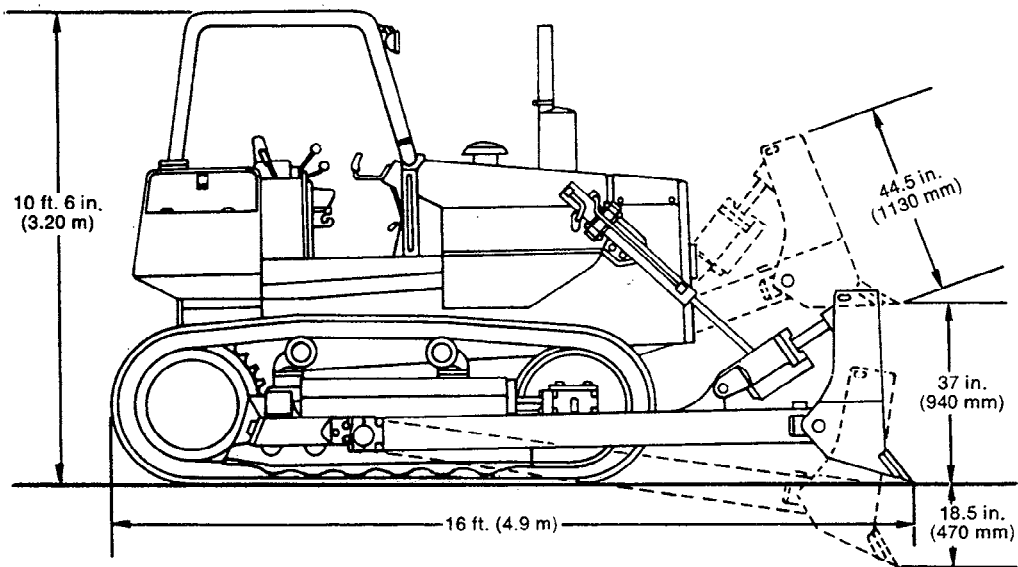

Limb risers and brush-protection assembly for roll-over protective structure

T94330

850 LOW GROUND PRESSURE BULLDOZER DIMENSIONS

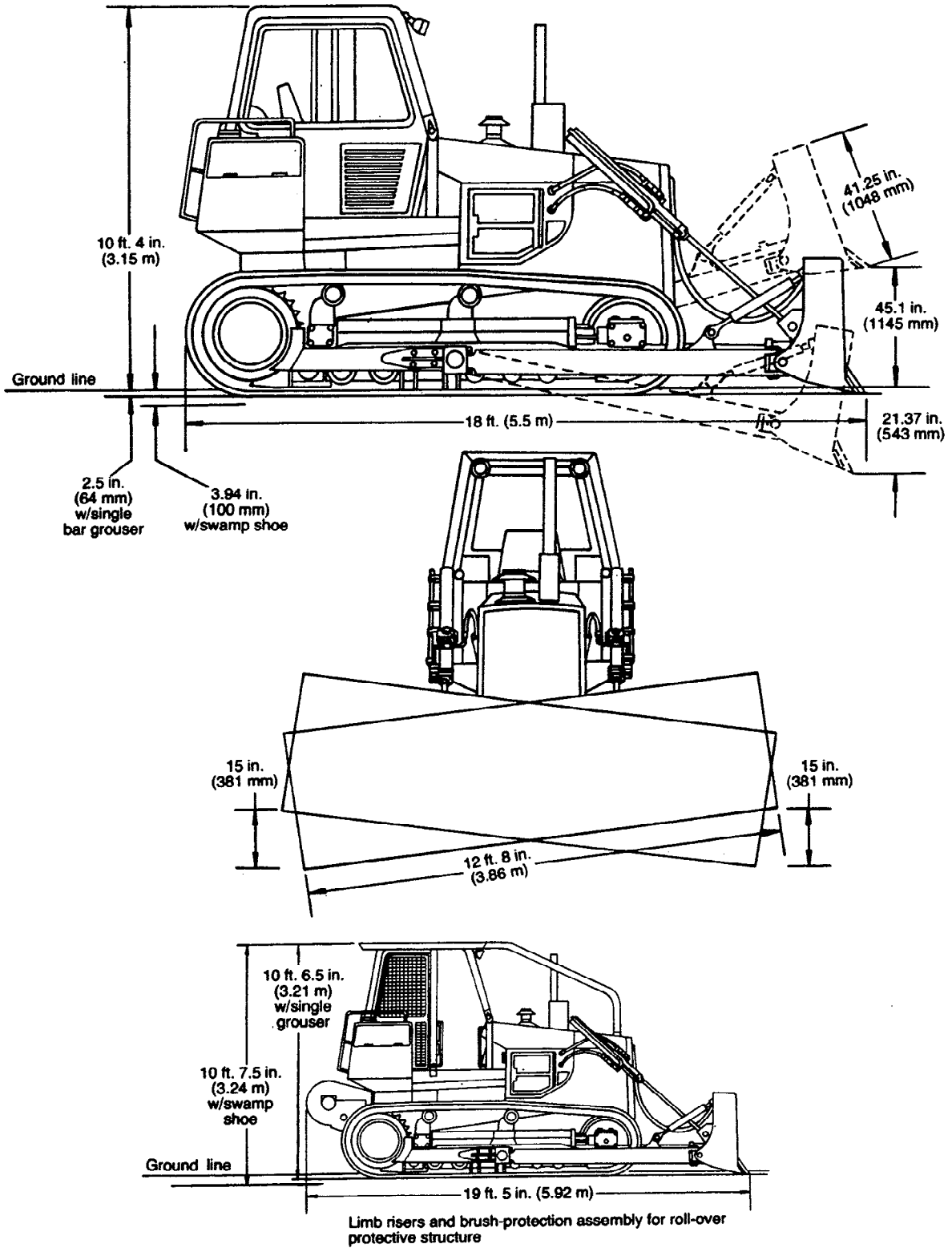

T94331

METRIC HARDWARE TORQUE SPECIFICATIONS

NOTE: Torques shown are for hardware with SAE 30W oil on threads.

NOTE: Torque wrench tolerance is ± 10 percent of specified torque.

Metric Standard Thread

Thread	8.8		10.9		12.9	
	N·m	(lb-ft)	N·m	(lb-ft)	N·m	(lb-ft)
M5	5.9	(4.4)	7.9	(5.8)	9.8	(7.2)
M6	9.8	(7.2)	13.8	(10.2)	16.7	(12.3)
M8	24.6	(18.1)	34.4	(25.4)	40.2	(29.6)
M10	48.1	(35.5)	67.8	(50.0)	81.5	(60.1)
M12	84.4	(62.2)	118.0	(87.0)	142.0	(105.0)
M14	133.0	(98.0)	187.0	(138.0)	226.0	(167.0)
M16	206.0	(152.0)	290.0	(214.0)	348.0	(257.0)
M18	285.0	(210.0)	398.0	(294.0)	476.0	(351.0)
M20	402.0	(296.0)	570.0	(420.0)	677.0	(499.0)
M22	540.0	(398.0)	765.0	(564.0)	914.0	(674.0)
M24	697.0	(514.0)	980.0	(723.0)	1180.0	(870.0)

Metric Fine Thread



Thread	8.8		10.9		12.9	
	N·m	(lb-ft)	N·m	(lb-ft)	N·m	(lb-ft)
M8 x 1	26.5	(19.5)	37.3	(27.5)	44.2	(32.6)
M10 x 1	47.1	(34.7)	68.8	(50.7)	81.5	(60.1)
M12 x 1.5	88.4	(65.2)	123.0	(91.0)	147.0	(108.0)
M14 x 1.5	147.0	(108.0)	206.0	(152.0)	246.0	(181.0)
M16 x 1.5	221.0	(163.0)	309.0	(228.0)	373.0	(275.0)
M18 x 1.5	319.0	(235.0)	451.0	(333.0)	540.0	(398.0)
M20 x 1.5	451.0	(333.0)	628.0	(463.0)	755.0	(557.0)
M22 x 1.5	559.0	(442.0)	845.0	(623.0)	1030.0	(760.0)
M24 x 2	765.0	(564.0)	1080.0	(796.0)	1275.0	(940.0)
M26 x 2	1130.0	(833.0)	1570.0	(1158.0)	1915.0	(1412.0)

CUSTOMARY HARDWARE TORQUE SPECIFICATIONS

NOTE: Torques shown are for dry (no lubrication on threads) hardware.

NOTE: Torque wrench tolerance is ± 10 percent of specified torque.

Customary Hardware

Cap Screw Size-Inches	 Grade B		 Grade D		 Grade F	
	lb-ft.	(N-m)	lb-ft.	(N-m)	lb-ft.	(N-m)
1/4	----	----	10	(14)	14	(19)
5/16	----	----	20	(27)	30	(41)
3/8	----	----	35	(47)	50	(68)
7/16	35	(47)	55	(75)	80	(108)
1/2	55	(75)	85	(115)	120	(163)
9/16	75	(102)	130	(176)	175	(237)
5/8	105	(142)	170	(230)	240	(325)
3/4	185	(251)	300	(407)	425	(576)
7/8	160	(217)	445	(603)	685	(929)
1	250	(339)	670	(908)	1030	(1396)
1-1/8	330	(447)	910	(1234)	1460	(1979)
1-1/4	480	(651)	1250	(1695)	2060	(2793)

T88804

O-RING BOSS FITTING SERVICE RECOMMENDATIONS

1. Inspect boss O-ring seat. It must be free of dirt and defects. If repeated leaks occur, inspect for defects with a magnifying glass. Some raised defects can be removed with a slip stone.

Occasionally a lower durometer O-ring will seal against a rough seat. If neither of these solutions work, the component must be replaced.

2. Put hydraulic oil, petroleum jelly or soap on the O-ring. Put a thimble over the threads to protect O-ring from nicks. Slide O-ring over the thimble and into the turned down section of fitting.

For angle fittings, loosen special nut and push special washer against threads so O-ring can be installed into the turned down section of fitting.

3. Turn fitting into the boss by hand until special washer or washer face (straight fitting) contacts boss face and O-ring is squeezed into its seat.

4. To position angle fittings, turn the fitting counter-clockwise a maximum of one turn.

5. Tighten straight fittings to the torque value shown in chart. For angle fittings, tighten the special nut to valve shown in the chart while holding body of fitting with a wrench.

STRAIGHT FITTING OR SPECIAL NUT TORQUE (1)

Thread Size	Torque ¹		Number Of Flats ²
	N·m	(lb-ft)	
3/8-24 UNF	8	(6)	2
7/16-20 UNF	12	(9)	2
1/2-20 UNF	16	(12)	2
9/16-18 UNF	24	(18)	2
3/4-16 UNF	46	(34)	2
7/8-14 UNF	62	(46)	1-1/2
1-1/16-12 UNF	102	(75)	1
1-3/16-12 UNF	122	(90)	1
1-5/16-12 UNF	142	(105)	3/4
1-5/8-12 UNF	190	(140)	3/4
1-7/8-12 UNF	217	(160)	1/2

1. Tolerance \pm 10%.

2. To be used if a torque wrench cannot be used. After tightening fitting by hand, put a mark on nut and boss; then tighten special nut or straight fitting the number of flats shown.

TUBE AND HOSE FITTING, 37° FLARE AND 30° CONE SEAT CONNECTOR SERVICE RECOMMENDATIONS

1. Inspect the flare and the flare seat. They must be free of dirt and defects. If repeated leaks occur, inspect for defects with a magnifying glass. If burrs and raised nicks on the connector body cannot be removed with a slip stone, replace the connector.

2. Defects in the tube flare cannot be repaired. Replace the tube. Overtightening a defective flared fitting will not stop leaks.

3. As a field repair, a ductile truncated cone shaped washer can be used between the tube flare and connector body. These washers are soft enough to fill defects in the seat and flare. They will also seal the connection. Ductile washers are available from industrial supply houses.

4. Align the tube with the fitting before attempting to start the nut. Failure to do so can cause a deformed flare and subsequent leaks. Install hoses without twists. A twisted hose attempts to straighten out when pressure is applied. This exerts a torque on the connection, eventually causing failure.

5. Lubricate the connection with hydraulic fluid, petroleum jelly or soap. Tighten the swivel nut by hand until it is snug.

6. Mark a line across the nut and connector body. This line will serve as a visual indicator as to whether the nut has been tightened and by how much.

7. Using two wrenches, one on the connector body and a torque wrench on the nut, tighten the nut to the torque value as shown in the chart. In the case of a hose, it may be necessary to use three wrenches to prevent twisting.

TUBE AND HOSE FITTING, 37° FLARE AND 30° CONE SEAT CONNECTOR TORQUE

Thread Size	N'm	Torque ¹ (lb-ft)	New ² Number of Flats	Used ³ Number of Flats
3/8-24 UNF	8	(6)	2-1/2	1
7/16-20 UNF	12	(9)	2-1/2	1
1/2-20 UNF	16	(12)	2-1/2	1
9/16-18 UNF	24	(18)	2	1
3/4-16 UNF	46	(34)	2	1
7/8-14 UNF	62	(46)	1-1/2	1
1-1/16-12 UN	102	(75)	1	3/4
1-3/16-12 UN	122	(90)	1	3/4
1-5/16-12 UN	142	(105)	3/4	3/4
1-5/8-12 UN	190	(140)	3/4	3/4
1-7/8-12 UN	217	(160)	1/2	1/2

1. Tolerance of $\pm 10\%$.

2. To be used if a torque wrench cannot be used. After tightening fitting by hand, put a mark across the fittings, then tighten fitting the number of flats shown.

3. Flare connection seal by deforming or squeezing the tube between the nut and the connector. More deformation is possible with new parts than with old. Therefore, if a torque wrench is not used for re-assembly, the values in this column must be used to prevent damage.

SAE FOUR BOLT FLANGE FITTING SERVICE RECOMMENDATIONS

1. Inspect the sealing surfaces for nicks or scratches, roughness or out-of-flat condition. Scratches cause leaks. Roughness causes seal wear. Out-of-flat causes seal extrusion. If these defects cannot be polished out, replace the component.

2. Install the correct O-ring (and backup washer if required) into the groove using petroleum jelly to hold it in place.

3. For split flange; loosely assemble split flange halves, being sure that the split is centrally located and perpendicular to the port. Hand tighten cap screws to hold parts in place. Do not pinch O-ring.

4. For single piece flange; put hydraulic line in the center of the flange and install four cap screws. With the flange centrally located on the port, hand tighten cap screws to hold it in place. Do not pinch O-ring.

5. For both single piece flange and split flange, be sure the components are properly positioned and cap screws are hand tight. Tighten one cap screw, then tighten the diagonally opposite cap screw. Tighten the two remaining cap screws. Tighten all cap screws within the specified limits shown in the chart.

DO NOT use air wrenches. DO NOT tighten one cap screw fully before tightening the others. DO NOT over-tighten.

SAE FOUR BOLT FLANGE FITTING TORQUE

Nominal Flange Size	Cap Screw Size ¹	Torque ²			
		N·m		(lb-ft)	
		Min.	Max.	Min.	Max.
1/2	5/16 - 18 UNC	20	31	(15)	(23)
3/4	3/8 - 16 UNC	28	54	(21)	(40)
1	3/8 - 16 UNC	37	54	(27)	(40)
1-1/4	7/16 - 14 UNC	47	85	(35)	(63)
1-1/2	1/2 - 13 UNC	62	131	(46)	(97)
2	1/2 - 13 UNC	73	131	(54)	(97)
2-1/2	1/2 - 13 UNC	107	131	(79)	(97)
3	5/8 - 11 UNC	158	264	(117)	(195)
3-1/2	5/8 - 11 UNC	158	264	(117)	(195)
4	5/8 - 11 UNC	158	264	(117)	(195)
5	5/8 - 11 UNC	158	264	(117)	(195)

1. SAE Grade 5 or better cap screws with plated hardware.

2. Tolerance $\pm 10\%$. The torques given are enough for the given size connection with the recommended working pressure. Torques can be increased to the maximum shown for each cap screw size if desired. Increasing cap screw torque beyond this maximum will result in flange and cap screw bending and connection failures.

O-RING FACE SEAL FITTING SERVICE RECOMMENDATIONS

1. Inspect the sealing surfaces for nicks or scratches, roughness, or out-of-flat condition. Scratches cause leaks. Roughness causes seal wear. Out-of-flat causes seal extrusion. If these defects cannot be polished out, replace the component.

2. Lubricate O-ring and male threads with petroleum jelly.

For O-ring face seal fittings, push O-ring into groove.

For O-ring boss fittings, put a thimble over the threads to protect O-ring from nicks. Slide O-ring over the thimble and into the turned down section of fitting.

For angle fittings, loosen special nut and push special washer against threads so O-ring can be installed into the turned down section of fitting.

3. Install fitting and hand tighten until snug. To position angle fittings, turn fitting counterclockwise a maximum of one turn.

4. Tighten fitting for nut to the torque value shown in chart. Use one wrench to hold connector body and another wrench to tighten nut. When tightening a fitting on a hose, it may be necessary to use three wrenches to prevent twisting hose; one on the connector body, one on the nut, and one on the body of the hose fitting.

O-RING FACE SEAL FITTING TORQUE (1)

Nominal		Dash Size	Thread Size in.	O-Ring Face Seal End				O-Ring Boss End		
Tube mm	O.D. in.			Swivel Nut Torque		Bulkhead Nut Torque		Thread Size in.	Straight Fitting or Jam Nut Torque	
				N'm	lb-ft	N'm	lb-ft		N'm	lb-ft
4.76	0.188	-3	— — —	—	—	—	—	3/8-24	8	6
6.35	0.250	-4	9/16-18	16	12	5.0	3.5	7/16-20	12	9
7.94	0.312	-5	— — —	—	—	—	—	1/2-20	16	12
9.52	0.375	-6	11/16-16	24	18	9.0	6.5	9/16-18	24	18
12.70	0.500	-8	13/16-16	50	37	17.0	12.5	3/4-16	46	34
15.88	0.625	-10	1-14	69	51	17.0	12.5	7/8-14	62	46
19.05	0.750	-12	1-3/16-12	102	75	17.0	12.5	1-1/16-12	102	75
22.22	0.875	-14	1-3/16-12	102	75	17.0	12.5	1-3/16-12	122	90
25.40	1.000	-16	1-7/16-12	142	105	17.0	12.5	1-5/16-12	142	105
31.75	1.250	-20	1-11/16-12	190	140	17.0	12.5	1-5/8-12	190	140
38.10	1.500	-24	2-12	217	160	17.0	12.5	1-7/8-12	217	160

1. Tolerance: +15-20%.

Group IV PREDELIVERY, DELIVERY, AND AFTER-SALE SERVICES

TEMPORARY STORAGE

After receiving your crawler from the factory and before putting the machine into temporary storage perform the following checks:

1. Check battery electrolyte level and charge the battery, if necessary.
2. Check coolant level in the radiator. The coolant should be maintained at a level midway between the radiator core and filler neck.
3. Fill the fuel tank.
4. Check crankcase oil level. Oil should be at top mark of dipstick after crawler has been shut down for 10 minutes.
5. Relieve hydraulic pressure by stopping engine, lowering all equipment and operating control levers until system fails to respond.

PREDELIVERY SERVICE

Because of the shipping factors involved, plus extra finishing touches that are necessary to promote customer satisfaction, proper predelivery service is of prime importance to the dealer and the customer.

If adjustments are required, procedures are found in the After-Sale section.

Install blade before starting the following predelivery points.

Use the following list when preparing a crawler bulldozer for delivery to the customer.

1. Air Cleaner

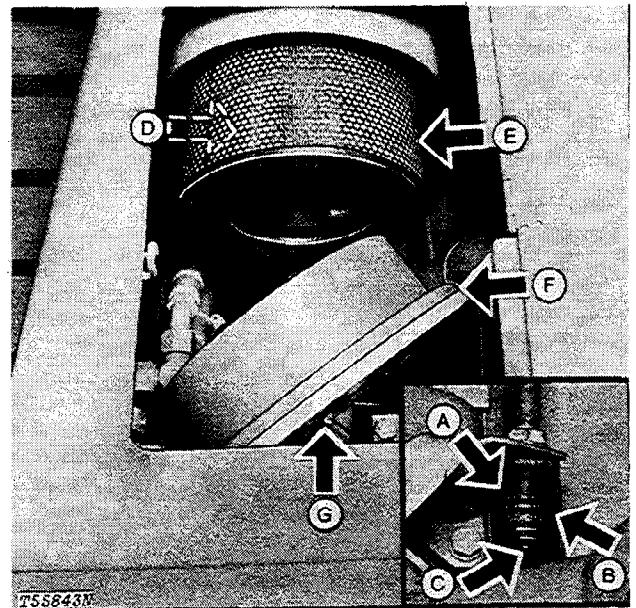

- | | |
|-------------------------|-------------------|
| A—Red Signal | E—Primary Element |
| B—Restriction Indicator | F—Cover |
| C—Reset Button | G—Wing Nut |
| D—Safety Element | |

Fig. 1—Air Cleaner

Check air filter restriction indicator. If red signal locks in full view, look for restriction or blockage in air intake system.

Air cleaner elements checked	Yes	No
Restriction in system	Yes	No

2. Fuel Filters



Fig. 2-Drain Plugs



Fig. 3-Hand Primer

Check fuel filters for sediment. Drain if necessary. To drain:

- 1 - Loosen drain plugs.
- 2 - Turn hand primer counterclockwise to loosen.
- 3 - Pull hand primer up and pump the primer until a solid stream of fuel, free from air bubbles, flows from the drain plug holes.
- 4 - Tighten drain plugs.
- 5 - Bleed fuel system as follows:
 - A - Loosen bleed plug.
 - B - Turn hand primer counterclockwise to loosen.
 - C - Pull hand primer up and pump the primer until a solid stream of fuel, free from air bubbles, flows from the bleed plug.
 - D - Tighten bleed plug.
 - E - Push hand primer down completely and hand tighten. Turn knob clockwise to tighten.

Sediment present in filters Yes No

3. Air Intake Hose

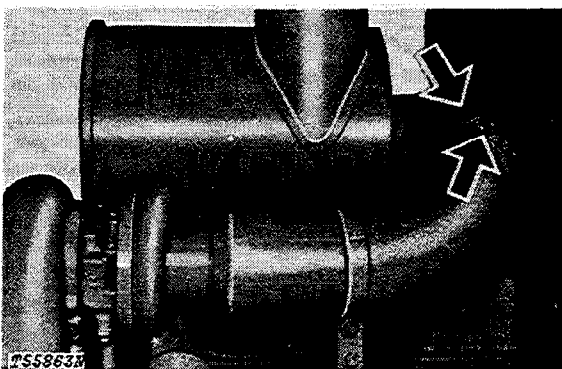

Fig. 4-Air Intake Hose Connections

Check clamps on hose connecting air cleaner and engine. Tighten two hose clamps. Inspect hose for cracks.

Air intake hose checked Yes No
 Loose connections Yes No

4. Batteries

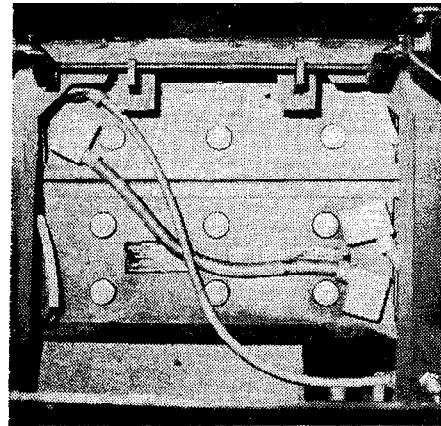

Fig. 5-Batteries

Check battery electrolyte level. If distilled water is not available, use clean soft water. Avoid use of hard water. Remove foreign material from top of battery and coat terminals with petroleum jelly.

IMPORTANT: Never add water to battery in freezing weather unless engine is to be run 2 or 3 hours to assure mixing of water and electrolyte.

Check battery connections.

Punch date code on battery.

Water added	Yes	No
Batteries checked and serviced	Yes	No

5. Fuel Tank

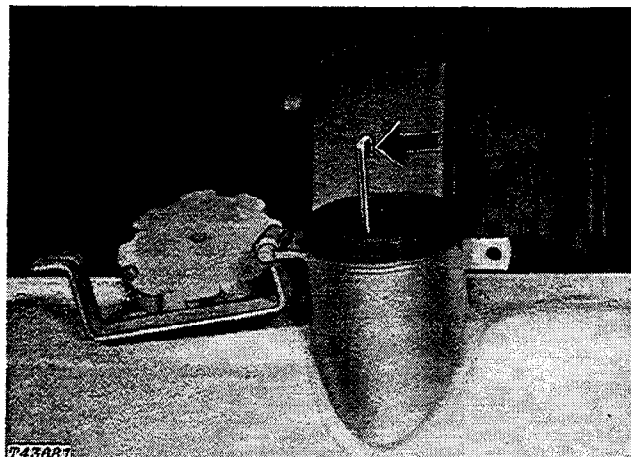

Fig. 6-Fuel Tank

Check fuel tank level. If low, add sufficient fuel to fill the tank. Capacity is 82 gal. (310.4 L). Check fuel system for leaks.

Fuel tank level	Full	1/2-Full	Empty	
-----------------	------	----------	-------	--

6. Fuel Tank Sump

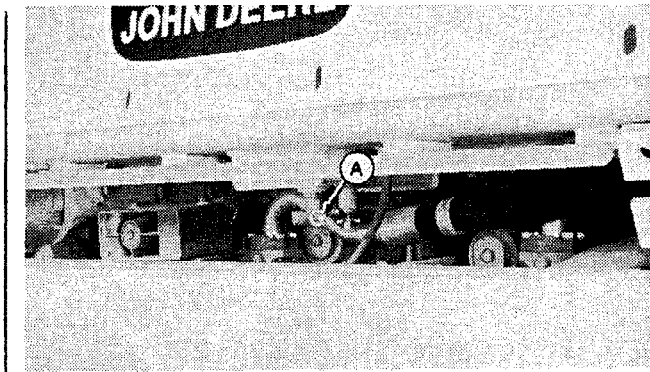

Fig. 7-Drain Cock

Drain sump after crawler has been stopped for 3-4 hours.

To drain sump:

- 1 - Loosen lower bolt on access cover and pivot cover down.
- 2 - Open drain cock.
- 3 - Drain fuel until it is clear of water, dirt, etc.
- 4 - Close drain cock.
- 5 - Replace access cover and tighten bolt.

Fuel tank sump checked	Yes	No
Fuel tank sump drained	Yes	No

7. Radiator

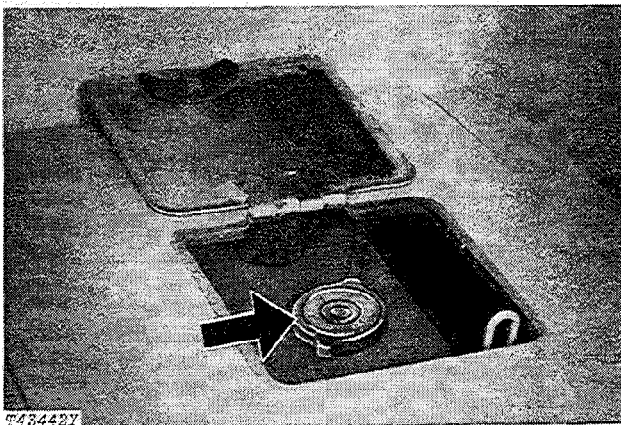

Fig. 8-Radiator Filler Cap

CAUTION: Do not remove radiator filler cap unless engine is cool. Then loosen cap slowly to the stop to relieve any excess pressure before removing cap completely.

Check coolant level in radiator. Coolant should be at the bottom of the filler neck.

The antifreeze-water ratio is approximately 50 percent each. This protects to at least -34°F (-37°C).

Check to make sure the two shut-off valves on both sides of the engine coolant conditioner-filter are opened completely.

Radiator coolant level checked	Yes	No
Coolant or antifreeze added	Yes	No

8. Crankcase Oil Level

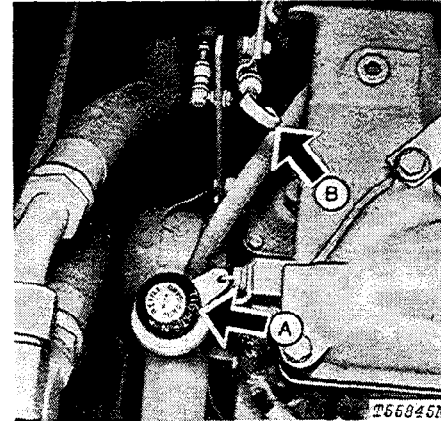

A—Oil Filler Cap

B—Dipstick

Fig. 9-Crankcase Oil Level

Check crankcase oil level with unit on level ground and engine shut off. Wait 10 minutes for oil to drain into oil pan. If oil level is at or below bottom mark on dipstick, add oil specified in the Lubrication section to bring oil level to between marks on dipstick. Do not operate engine with oil level below the bottom mark.

Crankcase oil level checked	Yes	No
Oil added	Yes	No

9. Front Idlers, Track Rollers and Carrier Rollers

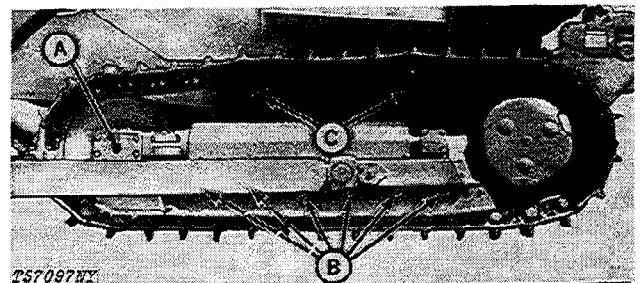

A—Front Idler Check Plug

C—Carrier Rollers Check Plugs

B—Track Rollers Check Plugs

Fig. 10-Track Area Oil Levels

Check oil level in the upper idlers. Oil level should be at check plug. If low, add oil specified in the Lubrication section to bring level up to check plug.

12. Hydrostatic Transmission Oil Level

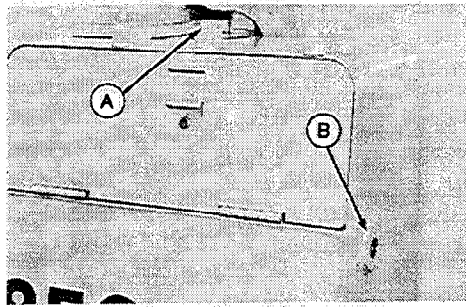

T90222

Fig. 14-Transmission Sump

Park the crawler on a level surface and stop the engine. Transmission oil level should be visible in oil level window (B).

CAUTION: The hydrostatic transmission system is a sealed design and has no vent. Remove filler plug (A) slowly to release pressure. When replacing the filler plug, be sure it is screwed down tight and the O-ring is in good condition.

If oil is not visible in window, add enough oil specified in the Lubrication section to bring up to this level. Check transmission system for leaks if oil level is low.

Transmission oil level checked	Yes	No
Oil added	Yes	No

13. Hydraulic Oil Level

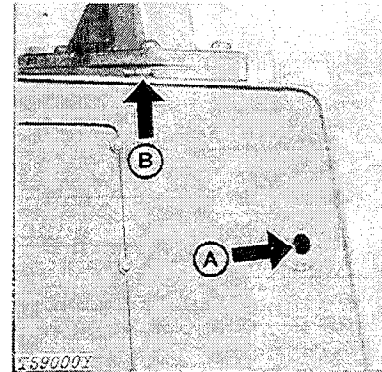

T59000

Fig. 15-Hydraulic Reservoir

Check oil level with crawler on a level surface, blade on ground, and ripper (if equipped) in transport position. Stop the engine.

Hydraulic oil level should be visible in oil level window (A).

CAUTION: The hydraulic reservoir is completely closed and pressurized. Slowly remove the fill plug (B) to relieve the reservoir pressure. When replacing the fill plug, be sure it is screwed down tight and the O-ring is in good condition.

If oil is not visible in window, add enough oil specified in the Lubrication section to bring up to this level. Check hydraulic system for leaks if oil level is low.

Hydraulic oil level checked	Yes	No
Oil added	Yes	No

14. Alternator-Fan-Compressor Belt Tension

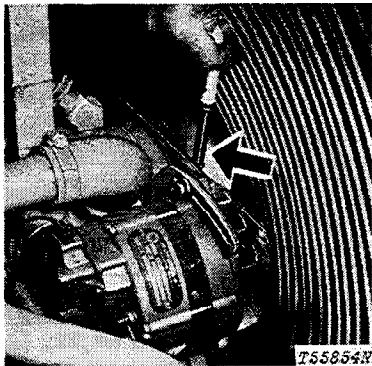

Fig. 16-Checking Belt Tension

Check alternator belt tension. A force of 18 lb (90 N) (8 kg) midway between pulleys should deflect belt 1/2-inch (13 mm).

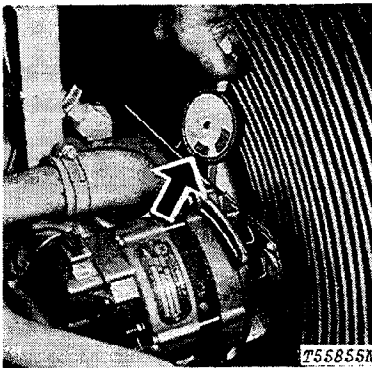

Fig. 17-Checking Strand Tension

If belt gauge is used, tighten used belt to 90 lb (400 N) (41 kg) strand tension. Tighten new belt to 135 lb (600 N) (61 kg).

If adjustment is required, see the After-Sale Inspection section.

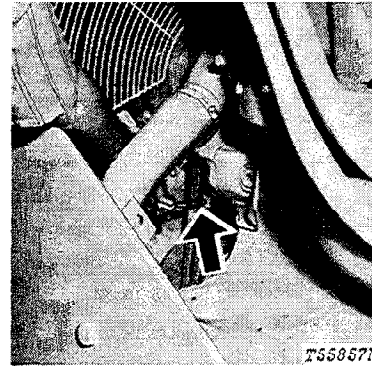

Fig. 18-Checking Belt Tension

Check fan belt tension. A force of 12 lb (53 N) (5 kg) midway between pulleys should deflect belt 1/2-inch (13 mm).

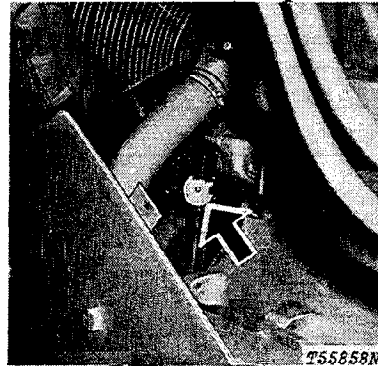

Fig. 19-Checking Strand Tension

If belt gauge is used, tighten used belt to 90 lb (400 N) (41 kg) strand tension. Tighten new belt to 100 lb (445 N) (45 kg).

If adjustment is required, see the After-Sale Inspection section.

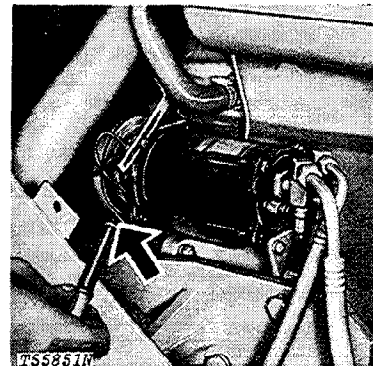

Fig. 20-Checking Belt Tension

Check compressor belt tension. A force of 15 lb (67 N) (7 kg) midway between pulleys should deflect belt 1/4-inch (6 mm).

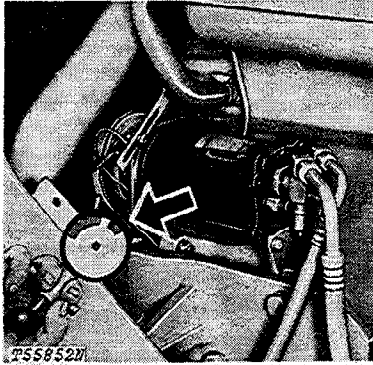

Fig. 21—Checking Strand Tension

If belt gauge is used, tighten used belt to 90 lb (400 N) (41 kg) strand tension. Tighten new belt to 135 lb (600 N) (61 kg).

If adjustment is required, see the After-Sale Inspection section.

Alternator belt tension	_____lbs. (N) (kg) tension
	_____inch (mm) flex
Fan belt tension	_____lbs. (N) (kg) tension
	_____inch (mm) flex
Compressor belt tension	_____lbs. (N) (kg) tension
	_____inch (mm) flex

15. Engine Speeds

Warm up engine and attach a tachometer in the engine rotation tool hole to check engine speeds.

Fast idle speed should be 1940—1980 rpm. Slow idle should be 975—1000 rpm.

If engine speeds need adjustment, proceed as follows:

NOTE: Use to set fast and slow idle for engine operation.

NOTE: If fuel and air filters require servicing, do so prior to this test.

A. Warm up the engine.

B. Disconnect engine speed control cable quick disconnect end from injection pump lever (3, Fig. 22).

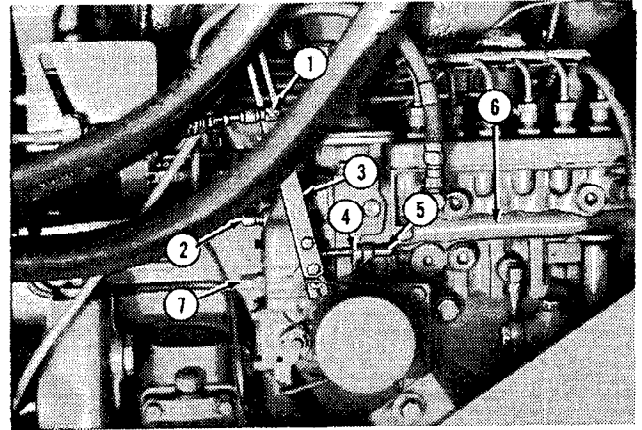

- | | |
|------------------------|----------------------------|
| 1—Speed Control Cable | 4—Fast Idle Screw |
| 2—Slow Idle Screw | 5—Fast Idle Screw Cap |
| 3—Injection Pump Lever | 6—Fuel Injection Pump |
| | 7—Supplementary Idle Screw |

Fig. 22—Engine Speed Adjustment

C. Check injection pump throttle lever for proper operation. Check to see that there is no debris between the fast idle screw and stop.

D. Run engine and rotate injection pump throttle lever fully forward until it touches the fast idle screw (4). Record engine speed. It should read 1940—1980 rpm. If not correct, adjust injection pump fast idle screw (4) to obtain specified speed.

E. Rotate injection pump lever to the rear until it contacts the slow idle stop. Record engine speed. It should read 975—1000 rpm. If not correct, turn supplementary idle screw (7) counterclockwise until engine rpm stops decreasing plus two more turns.

Turn slow idle screw (2) to adjust engine rpm to 960. Tighten lock nut.

Turn supplementary idle screw clockwise until rpm is 975—1000. Tighten lock nut. The best setting for supplementary idle screw is 25 rpm above slow idle screw setting.

NOTE: The slow idle screw (2) is protected by a cap. This cap must be removed to adjust the screw. Replace cap after adjustment is made.

IMPORTANT: Whenever either the fast or slow idle speeds are adjusted on the injection pump, the engine speed control lever to injection pump cable adjustment has to be made. Refer to Group 9026 for this adjustment.

Use the following test to check engine speed control linkage and automatic control valve linkage synchronization. This test requires a 100 ft (305 m) flat area to drive the machine.

1. Run the engine at slow idle.
2. Move the FNR speed control handle forward to approximately 3/4 speed position.
3. Slowly and evenly increase engine rpm at a rate in which the machine will travel approximately 100 ft (305 m) when fast idle position is obtained.
4. Run the engine at fast idle.
5. Slowly and evenly decrease engine speed at a rate in which the machine will travel approximately 100 ft (305 m) when slow idle position is obtained.
6. The machine must not slow down or stop at any point in the rpm range. If a rpm decrease (dead spot) occurs, the engine speed control linkage and automatic control valve linkage are not synchronized. See Section 90 of this manual for adjustment.

Engine speeds checked	Yes	No
Adjustment required	Yes	No

16. Track Sag Adjustment

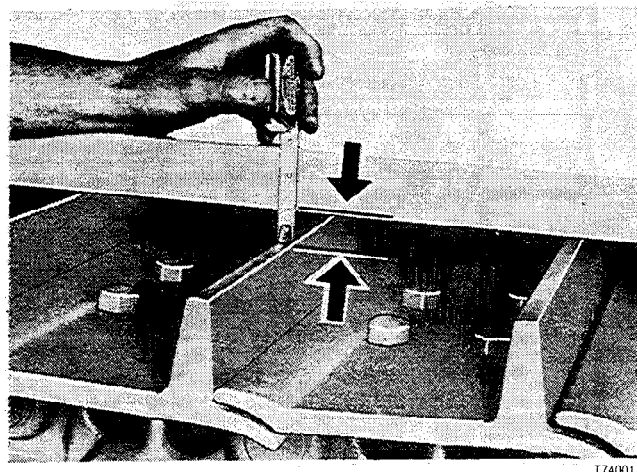

A—Front Idler
 B—Carrier Roller
 C—1 to 1-1/2 in.
 (25.4 to 38 mm)

Fig. 23-Measuring Track Sag

Check the amount of sag in center of track between front carrier roller and front idler. Sag should be 1 to 1-1/2 inches (25.4 to 38 mm). If adjustment is required, see the After-Sale Inspection section.

Check the vertical and horizontal movement of the front idler assembly on the track frame. If adjustment is required, see the After-Sale Inspection section.

Check the carrier rollers for proper alignment with the track. If adjustment is required, see the After-Sale Inspection section.

Track tension checked	Yes	No
Front idler carrier roller wear checked	Yes	No
Adjustment required	Yes	No

17. Seat Operation

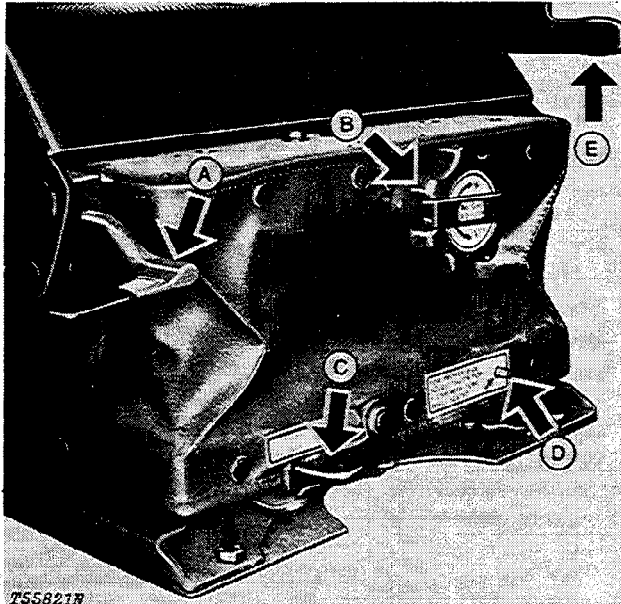

T558218
 A—Height Adjustment Lever D—Weight Adjustment Indicator
 B—Weight Adjustment Spinner E—Tilt Adjustment Lever
 C—Forward/Rearward Adjustment Lever

Fig. 30—Seat Adjustments

To adjust height, push down on lever (A, Fig. 30) to move seat to the desired position. Release lever. To adjust weight, turn spinner (B) until indicator (D) is flush with tube when seated. Use flip-out handle on the spinner for rapid adjustment. To adjust forward or rearward, lift up on lever (C) and slide seat to the desired position. Release lever. To adjust tilt, lift up on lever (E) to tilt seat backward or push down to tilt seat forward. Release lever.

Seat operational Yes No

18. Indicator Lights and Gauges

When operating the crawler, check the following gauges for correct operation.

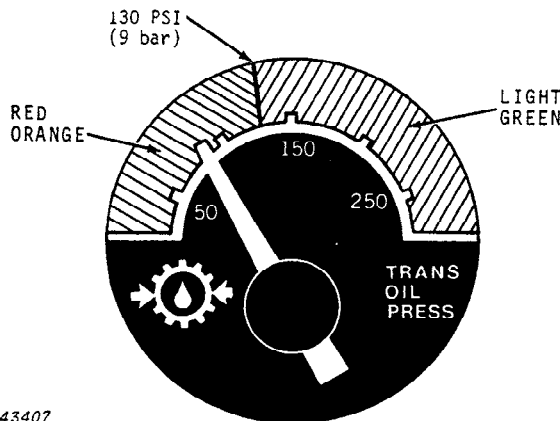

T43407
 Fig. 31—Transmission Oil Pressure Gauge

Litho in U.S.A.

Normal operating range is in the light green zone.

Check transmission oil pressure gauge during operation. If transmission oil pressure is not in the light green zone, shut off engine. Check transmission oil level. If oil is at proper level, troubleshoot the transmission system, checking for bent or broken lines and hoses. Also check for excessive leakage.

Transmission oil pressure may register slightly above the green zone in neutral or at full engine speed.

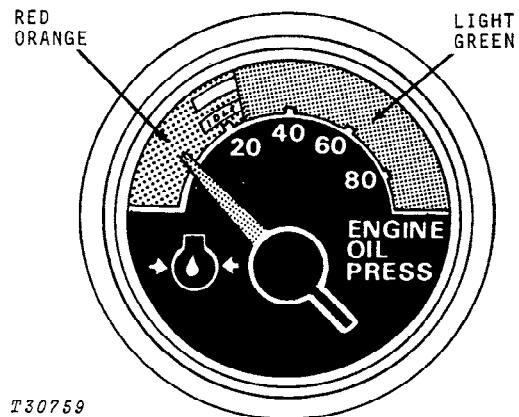

T30759

Fig. 32—Engine Oil Pressure Gauge

If the indicator hand of the engine oil pressure gauge drops into the red-orange zone, stop the crawler and check engine oil level. If oil level is not low, check for restrictions in oil lines or incorrect viscosity oil.

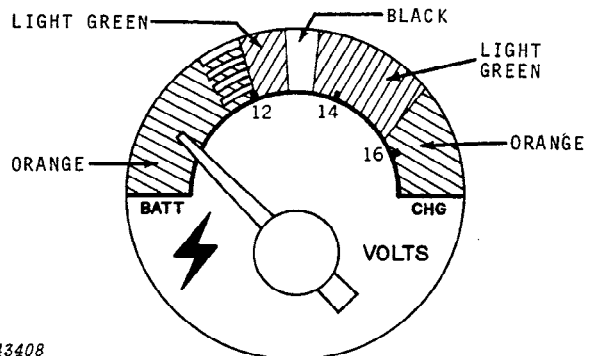

T43408

Fig. 33—Voltmeter

With key switch on and engine off, the indicator should be in the lower left light green zone.

When cranking the engine, the indicator will fall into the left-hand orange zone. When the engine starts, the indicator should move to stay in the right-hand light green zone.

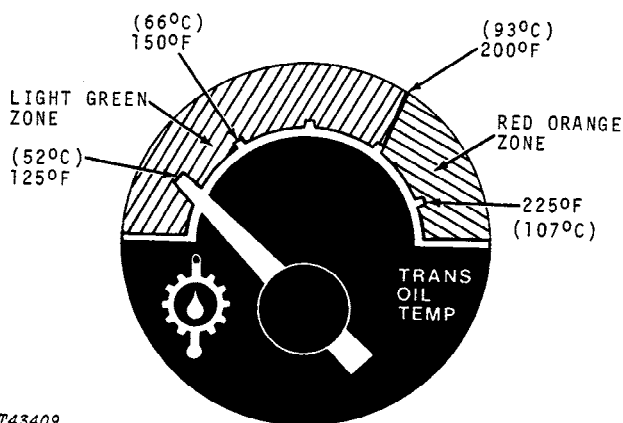

T43409

T43409

Fig. 34-Transmission Oil Temperature Gauge

Do not permit this temperature to exceed 200°F (93°C). If the temperature reaches this point during normal operation of the crawler, stop the engine and locate the trouble.

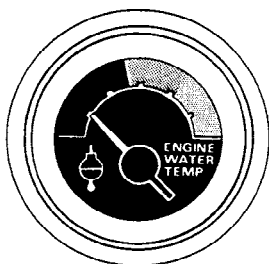

T30897N

T30897N

Fig. 35-Engine Water Temperature Gauge

Normal operating temperature is in the light green zone.

If the indicator hand of the engine water temperature gauge goes into the red-orange zone, stop engine and check cooling system.



T23111N

T23111N

Fig. 36-Transmission Oil Filter Restriction Indicator Light

NOTE: Light should glow, if operative, with key switch in start position and engine off.

When the engine is running, the transmission oil filter restriction indicator light should go out, indicating that there is no restriction in the transmission and oil filters. If light glows red while the engine is running, stop engine and determine cause.

The transmission oil filter restriction indicator light glows red also if the pressure switch located with the engine oil pressure sending unit is faulty, if the engine oil pressure is low, or if the oil is cold during initial startup.

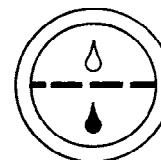

T38471N

T38471N

Fig. 37-Hydraulic Oil Filter Restriction Indicator Light

NOTE: Light should glow, if operative, with key switch in start position and engine off.

When the engine is running, the hydraulic oil filter indicator light should go out. If light glows red while the engine is running, stop engine and determine cause.

Lights may glow during initial operation until oil warms.

Gauges operational

Yes No

19. Light Operation

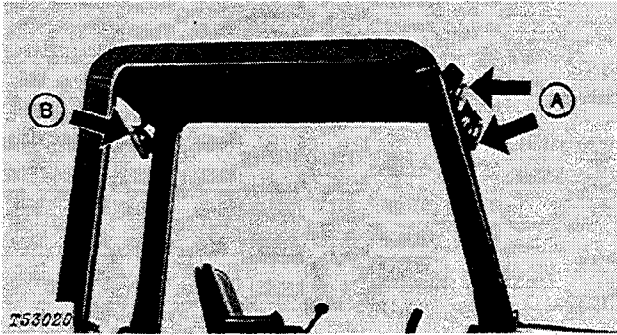

A—Front Lights

B—Rear Light

Fig. 38-Lights

All lights are controlled by the "push-pull" light switch. To turn on lights, pull out switch knob. To turn off lights, push in switch knob. The key switch must be in the "on" position before the lights will operate.

Lights operational Yes No

20. Transmission Control

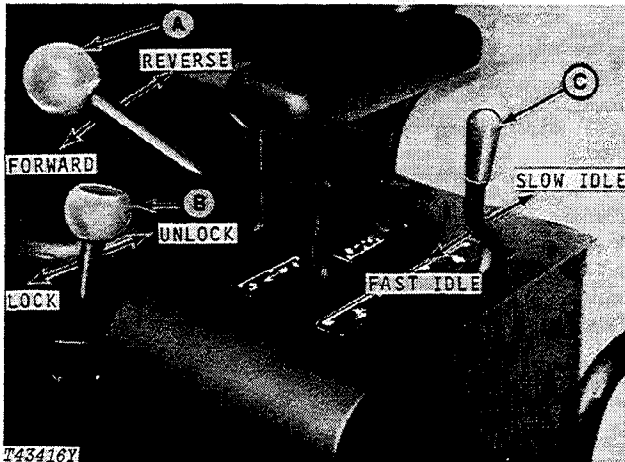

A—Forward and Reverse
 Speed Control Lever

B—Neutral Lock Lever
 C—Hand Throttle

Fig. 39-Transmission Shifting

Move the forward and reverse speed control lever forward from "neutral" to provide control of forward ground speeds from zero to maximum.

Move the lever rearward to control reverse ground speeds from zero to maximum. The forward and reverse speed control lever has a Z pattern movement to provide a positive location of the "neutral" position.

The forward and reverse speed control lever in "neutral" gives a braking effect. Engine braking is available as the control lever passes from forward or reverse speeds to neutral.

When the brake pedal is depressed, the forward and reverse speed control lever returns to the neutral position.

Transmission operational Yes No

21. Hydraulic Brake (Park Brake)

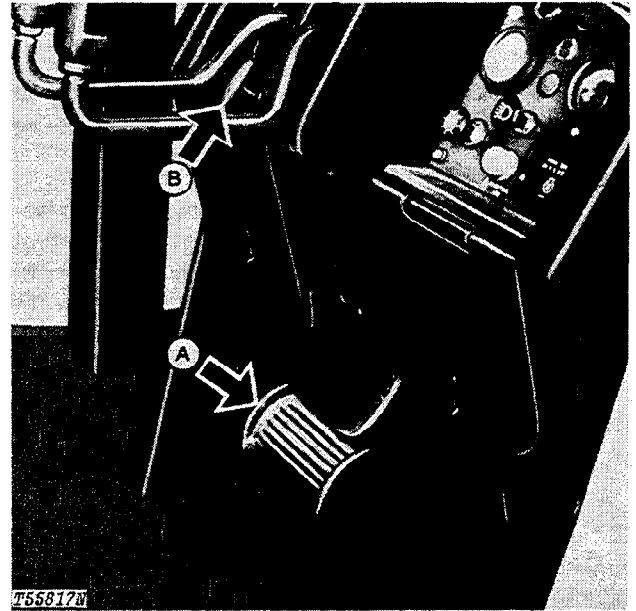

A—Park Brake Pedal

B—Park Brake Lock Knob

Fig. 40-Park Brake

When the brake pedal is depressed, the forward and reverse speed control lever returns to neutral automatically.

Operate the forward and reverse speed control lever to verify braking in neutral.

Brakes operational Yes No

22. Steering

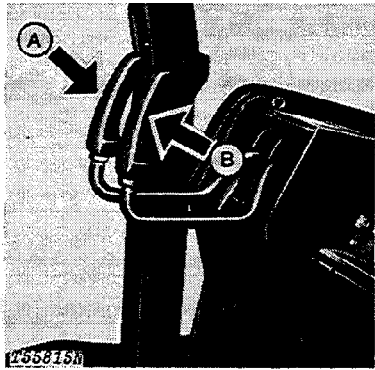

A—Left Steering Lever B—Right Steering Lever

Fig. 41-Steering Levers

Pull steering lever (right lever for right turn etc.) beyond the neutral position. This allows the tracks to travel in opposite directions. DO NOT attempt to pull both levers into this rearward position to reverse direction. A built-in locking feature prevents this from happening.

The same principle applies with pedal steering. Depressing pedal beyond neutral will reverse track rotation.

Steering operational Yes No

23. Lubrication

The crawler bulldozer was checked and lubricated before it left the factory. However, to insure customer satisfaction, check each lubrication point shown in the following pages. Lubricate with several strokes of John Deere Multi-Purpose Grease, if necessary.

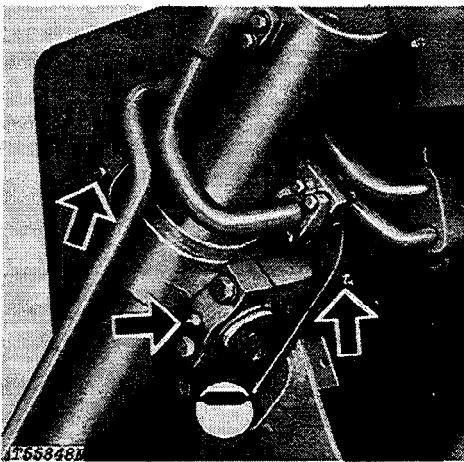

Fig. 42-Lift Cylinder Yokes and Trunnions (6 Points)

Lubricant required Yes No

Litho in U.S.A.

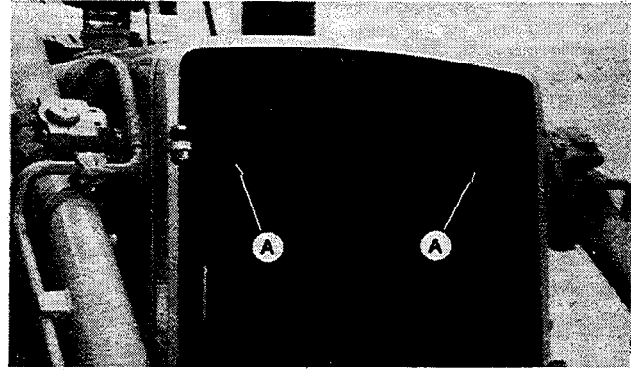

Fig. 42A-Crossmember (Low Ground Pressure)

Crossmember grease fittings (A) for Low Ground Pressure machines are serviced through the grille.

Lubricant required Yes No

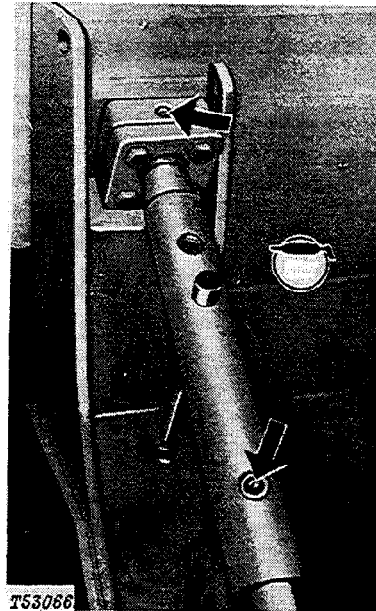

Fig. 43-Pitch Adjusting Jack and Socket (Dozer Blade) (2 Points)

Lubricant required Yes No

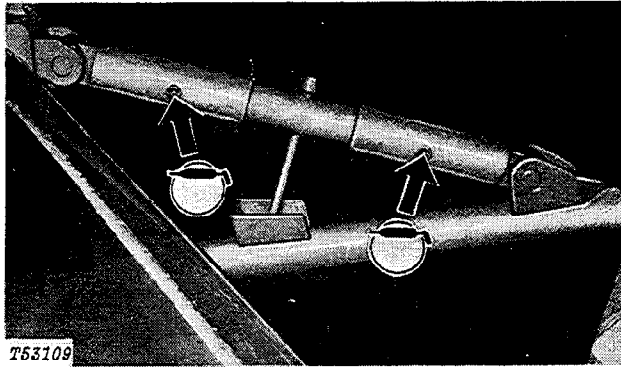

Fig. 44-Tilt Adjusting Jacks
 (Angle Dozer Blade) (4 Points)

Lubricant required Yes No

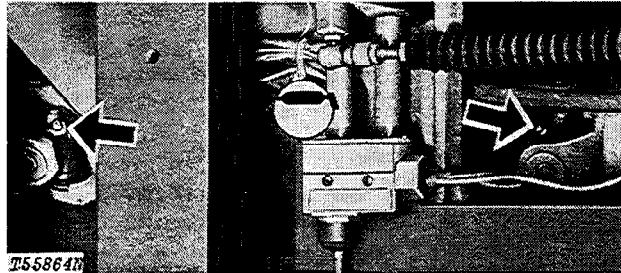

Fig. 45-Universal Joints (4 Points)

Lubricant required Yes No

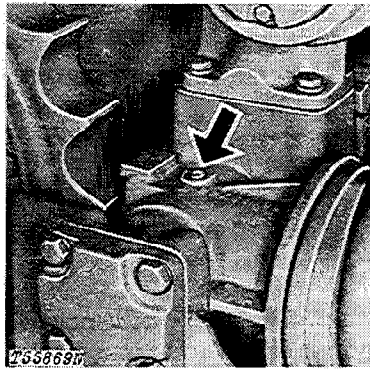

Fig. 46-Left and Right Track
 Frame Pivots (2 Points)

Remove plug. If fluid level is low, fill to top of shaft with a Multi-Purpose GL-5 Gear Oil - SAE 80W-90 weight meeting MIL-L-2105C specification or an equivalent. Replace plug.

Left and right track
 frame pivots checked Yes No
 Oil added Yes No

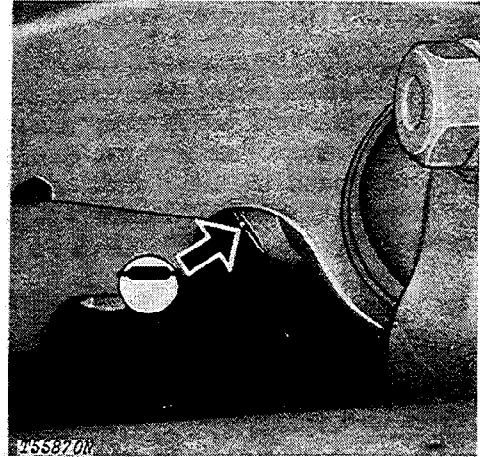
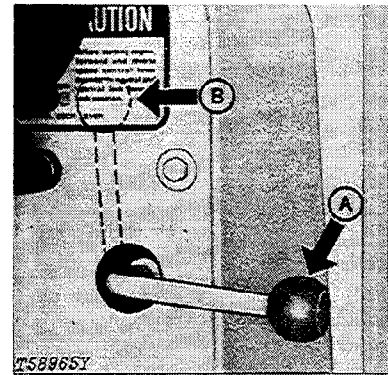

Fig. 47-Left and Right Track
 Frame Pivot Shaft (2 Points)

Lubricant required Yes No

24. Neutral Lock Lever Operation



A—Run Position B—Lock Position

Fig. 48-Neutral Lock Lever

Start crawler with neutral lock lever in the up (LOCK) position. The transmission is locked in the neutral position.

Move neutral lock lever to the down (UN-LOCK) position. The forward and reverse speed control lever is now unlocked, which makes it possible to drive the crawler.

Neutral lock lever operational Yes No



25. Accessible Hardware Torque Values

Check all accessible cap screws and nuts for proper tightness. If hardware seems loose, tighten it to the proper torque. The charts in this group give correct torque values for various bolts and cap screws. The table lists torques in the U.S. unit of measure (lb-ft) and SI metrics (N-m). Most hardware used is high-strength (note dashes on hex. heads).

The types of bolts and cap screws are identified by head markings as follows:

Plain Head: regular machine bolts and cap screws.

3-Dash Head: tempered steel high-strength bolts and cap screws.

6-Dash Head: tempered steel extra high-strength bolts and cap screws.

Machine bolts and cap screws 7/8-inch and larger are sometimes formed hot rather than cold, which accounts for the lower torque.

All accessible hardware torqued Yes No

26. Radiator Air Flow Pre-Test Inspection

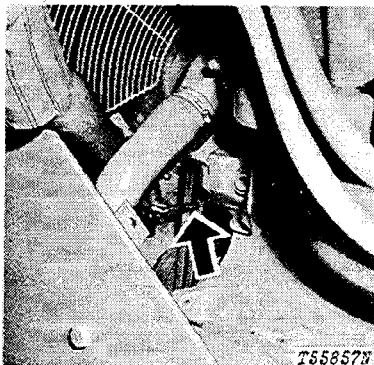

Fig. 48A-For Belt Tension

T55857

CAUTION: DO NOT remove radiator cap until radiator top tank feels cool.

1. Check coolant level.
2. Check belt tension. A force of 53 N (12 lb force) on belt halfway between pulleys must move belt 13 mm (0.500 in.). Adjust belt if necessary.

3. Check radiator fin condition. Make sure fins are not bent or damaged.

4. Check fan blade tips, shroud, and baffle, for damage. Fan blade tip to shroud distance must be equal at top and bottom.

5. Check for blower fan installation (sucker fan optional).

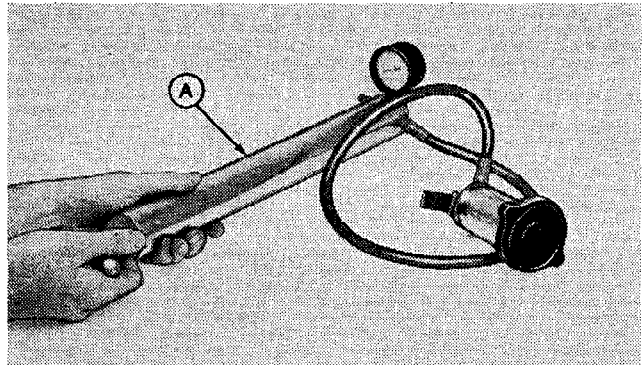

Fig. 48B-Checking Radiator Cap

T92483

6. Connect radiator cap to a D-05104ST Pressure Pump (A). Raise pressure until cap valve opens. Valve must hold pressure at 43 to 50 kPa (0.43 to 0.51 bar) (6.25 to 7.50 psi) for one minute. If pressure decreases, install a new cap.

27. Radiator/Oil Cooler Air Flow Test

1. Apply parking brake, put transmission in neutral, lock reverser lever in neutral, and start engine. Raise loader and install boom lock bar. Stop engine.

2. Remove side shields and grill screen.

3. Divide the surface of radiator into 16 equal squares with white chalk lines on the front of the radiator.

4. Install a D-01084AA Tachometer/Temperature Reader on the machine. Start engine and check low idle. Low idle must be 975-1000 rpm.

5. Run engine at 1075 rpm.

6. Connect JT05529 Air Flow Meter to D-27501BM Digital-Multimeter or JT27504 Heavy Duty Digital Multimeter. Turn switch on multimeter to 20 volts AC.

IMPORTANT: Unit is equipped with a blower fan (sucker fan is optional.).

Direction arrow on Air Flow meter must be away from radiator for blower fan and towards radiator for sucker fan.

7. Hold Air Flow Meter in direct contact with radiator with direction arrow toward radiator. Hold multimeter with other hand and stand to side of unit to prevent interference with air flow. Make a record of the multimeter reading for each square.

8. Compare readings to Pre-Delivery Inspection records or repeat entire procedure on a new unit, with the same equipment for comparison. If readings are reduced by 20% or more, remove oil cooler. Clean external surfaces of both oil cooler and radiator. Install oil cooler.

Air Flow Test Readings

Record sum of individual values for future reference:

T94610

28. Final Check

The final predelivery procedure is the overall cleanup of the crawler. Make the crawler LOOK like a new crawler with the proper touch-up of chipped paint and a good wash job. Deliver to the customer a crawler anyone would be proud to own.

DELIVERY SERVICE

A thorough discussion of the operation and service of this new crawler at the time of delivery helps to assure complete customer satisfaction. Proper delivery should be an important phase of the dealer's program. A portion of the John Deere Delivery Receipt emphasizes the importance of proper delivery service.

Many complaints arise because the owner was not shown how to operate and service the new crawler properly. Devote enough time at the customer's convenience, to introduce the owner to the new crawler. Explain how to operate and service it.

The following procedure is recommended before the service technician and owner complete the delivery acknowledgments portion of the Delivery Receipt.

Using the operator's manual as a guide, be sure that the owner understands these points thoroughly:

1. The importance of safety.
2. The importance of lubrication and periodic services.
3. The importance of the break-in period.
4. Controls and instruments.
5. How to start and stop the engine.
6. All functions of the hydraulic system.

After explaining and demonstrating the above features, have the owner sign the Delivery Receipt and give the owner the operator's manual.

AFTER-SALE INSPECTION

The purchaser of a new John Deere crawler is entitled to a free inspection at some mutually agreeable time within the warranty period after the equipment has been "run-in," usually after 50 to 100 hours of crawler operation. The terms of this after-sale inspection are outlined on the customer's John Deere Delivery Receipt.

The inspection is to make sure that the customer is receiving satisfactory performance from the crawler. At the same time, the inspection should reveal whether or not the crawler is being operated, lubricated, and serviced properly.

If the recommended after-sale service inspection is followed, the dealer can eliminate a needless volume of service work by preventing minor irregularities from developing into serious problems later on. This will promote strong dealer-customer relations and present the dealer an opportunity to answer questions that may have arisen during the first few days of operation.

During this inspection service, the dealer has the opportunity to promote the possible sale of other new equipment.

Check operation of all controls and instruments for freedom of movement and correct operation.



Suggest:

If the above button click is invalid.

Please download this document

first, and then click the above link

to download the complete manual.

Thank you so much for reading

1. Engine Crankcase Oil and Filter Element

NOTE: Check with the customer if oil has been changed and filter replaced before performing this service.

Normal sequence of service is as follows:

- Oil and Filter Change - after first 100 hours
- every 200 hours thereafter

If changed, record information below:

Approximate hours at change

If not, change as follows:

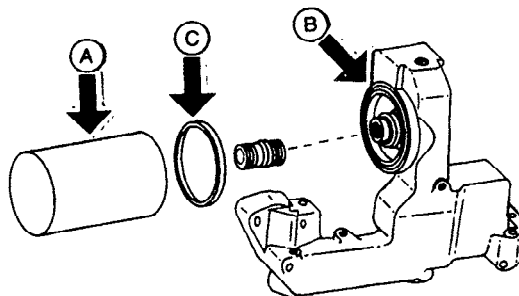

T57994N

A—Oil Filter Element
B—Mounting Surface

C—Sealing Ring

Fig. 52-Crankcase Oil Filter Component

- A - Remove filter element. (Turn counter-clockwise.)
- B - Clean mounting surface.
- C - Apply film of oil to sealing ring.
- D - Tighten element until sealing ring touches mounting surface.
- E - Turn an additional 1-1/2 turns.
- F - Do not overtighten.

- 5 - Fill crankcase with new oil of proper viscosity. Capacity is 32 quarts (30.3 L) without filter, 34 quarts (32.2 L) with filter.
- 6 - Run engine a short time and check for leaks at filter base and drain plug.
- 7 - Stop engine.
- 8 - Check oil level. Level should be between marks on dipstick.



T53078

Fig. 50-Engine Crankcase Drain Plug

- 1 - Run engine to heat oil.
- 2 - Drain oil from engine crankcase.
- 3 - While crankcase is draining, replace filter element as follows:

Crankcase oil changed
Oil filter element changed
Oil added, if any

Yes No
Yes No
____qts (L)

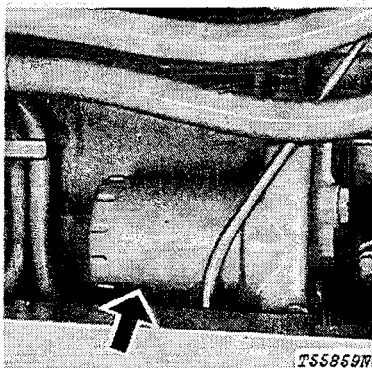

T55859W

Fig. 51-Engine Crankcase Filter Element

<https://www.ebooklibonline.com>

Hello dear friend!

Thank you very much for reading.

Enter the link into your browser.

The full manual is available for immediate download.

<https://www.ebooklibonline.com>