

**John Deere
JD770
Motor Grader**

**TECHNICAL
MANUAL**

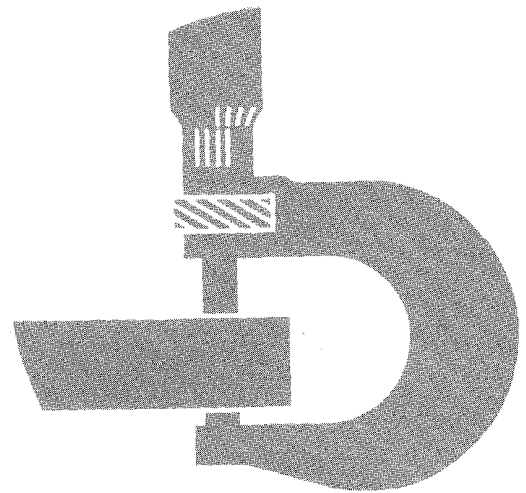

TM-1123

LITHO IN U.S.A.

SECTION AND GROUP CONTENTS OF THIS MANUAL

SECTION I - GENERAL INFORMATION

- Group I - Contents
- Group II - Introduction and Safety Information
- Group III - General Specifications
- Group IV - Predelivery, Delivery and After-Sale Services
- Group V - Lubrication

SECTION 1 - WHEELS AND TIRES

- Group 0110 - Powered Wheels, Tires and Fastenings
- Group 0120 - Non-Powered Wheels, Tires and Fastenings
- Group 0199 - Specifications and Special Tools

SECTION 2 - AXLES AND SUSPENSION SYSTEMS

- Group 0201 - Drive Axle Housings
- Group 0210 - Differential
- Group 0230 - Non-Powered Wheel Axles
- Group 0250 - Axle Shaft, Bearings and Reduction Gears
- Group 0299 - Specifications and Special Tools

SECTION 3 - TRANSMISSION

- Group 0315 - Controls
- Group 0341 - Housings and Covers
- Group 0350 - Gears, Shafts, Bearings and Power Shift Clutch
- Group 0360 - Transmission Hydraulics
- Group 0370 - Clutch Disconnect and Controls
- Group 0399 - Specifications and Special Tools

SECTION 4 - ENGINES

- Group 0400 - Engine Removal and Installation
- Group 0401 - Crankshaft and Main Bearings
- Group 0402 - Camshafts and Valve Actuating Means
- Group 0403 - Connecting Rods and Pistons
- Group 0404 - Cylinder Block
- Group 0407 - Engine Oiling System
- Group 0408 - Ventilating System
- Group 0409 - Cylinder Head and Valves
- Group 0410 - Exhaust Manifold
- Group 0413 - Fuel Injection System
- Group 0414 - Intake Manifold
- Group 0416 - Turbocharger
- Group 0417 - Water Pump
- Group 0418 - Thermostats, Housings and Piping
- Group 0419 - Engine Oil Cooler
- Group 0420 - Fuel Filter
- Group 0422 - Starting Motor and Fastenings
- Group 0433 - Flywheel, Housing and Fasteners
- Group 0499 - Specifications and Special Tools

SECTION 5 - ENGINE AUXILIARY SYSTEMS

- Group 0505 - Cold Weather Starting Aids
- Group 0510 - Engine Cooling Systems
- Group 0515 - Speed Controls
- Group 0520 - Intake System
- Group 0560 - External Fuel Supply Systems
- Group 0599 - Specifications and Special Tools

SECTION 8 - TRANSFER DRIVE

- Group 0841 - Housings and Covers
- Group 0851 - Gears, Shafts and Bearings
- Group 0899 - Specifications and Special Tools

SECTION 9 - STEERING SYSTEM

- Group 0960 - Power Steering
- Group 0999 - Specifications and Special Tools

SECTION 10 - SERVICE BRAKES

- Group 1011 - Service Brakes Active Elements
- Group 1015 - Controls Linkage
- Group 1066 - Brakes Hydraulics
- Group 1099 - Specifications and Special Tools

SECTION 11 - PARKING-EMERGENCY BRAKES

- Group 1111 - Parking Brake Active Elements
- Group 1115 - Controls Linkage
- Group 1199 - Specifications and Special Tools

SECTION 15 - EQUIPMENT ATTACHING

- Group 1511 - Drawbar

SECTION 16 - ELECTRICAL SYSTEMS

- Group 1671 - Batteries, Support and Cables
- Group 1672 - Alternator, Regulator and Charging System Wiring
- Group 1673 - Vehicle Lighting System
- Group 1674 - Wiring Harness and Switches
- Group 1675 - Automatic Control Systems and Controls
- Group 1676 - Instruments and Indicators
- Group 1699 - Specifications and Special Tools

SECTION 17 - FRAME, CHASSIS OR SUPPORTING STRUCTURE

- Group 1740 - Frame Installation
- Group 1746 - Bottom Guards
- Group 1747 - Vehicle Bumpers
- Group 1799 - Specifications and Special Tools

SECTION 18 - OPERATOR'S STATION

- Group 1806 - Safety Equipment
- Group 1808 - Comfort and Convenience Items
- Group 1810 - Operator Enclosure
- Group 1821 - Seat
- Group 1830 - Heating and Air Conditioning
- Group 1899 - Specifications and Special Tools

SECTION 19 - SHEET METAL

- Group 1910 - Hood or Engine Enclosure
- Group 1921 - Grille and Grille Housing

SECTION 21 - MAIN HYDRAULIC SYSTEM

- Group 2160 - Hydraulic System
- Group 2199 - Specifications and Special Tools

SECTION 34 - GRADING DEVICE

- Group 3401 - Blade
- Group 3415 - Controls Linkage
- Group 3440 - Grading Device Frames
- Group 3450 - Circle Gearbox
- Group 3460 - Hydraulic System
- Group 3499 - Specifications and Special Tools

SECTION 42 - Ground Conditioning Tools

- Group 4201 - Teeth and Shanks
- Group 4240 - Frames
- Group 4260 - Hydraulic System
- Group 4299 - Specifications and Special Tools

SECTION 46 - AUTOMATIC CONTROLS

- Group 4615 - Linkages
- Group 4640 - Frames and Housings
- Group 4660 - Hydraulic Components
- Group 4670 - Electrical Components
- Group 4699 - Specifications and Special Tools

SECTION 90 - SYSTEM TESTING

- Group 9005 - General Information - Seven Basic Steps of Testing and Diagnosis
- Group 9010 - Engine
- Group 9015 - Electrical System
- Group 9020 - Power Train
- Group 9025 - Hydraulic System
- Group 9030 - Miscellaneous Components
- Group 9032 - Automatic Blade Control
- Group 9035 - Specifications and Special Tools

II INDEX

<https://www.ebooklibonline.com>

Hello dear friend!

Thank you very much for reading.

Enter the link into your browser.

The full manual is available for immediate download.

<https://www.ebooklibonline.com>

Group II

INTRODUCTION AND SAFETY INFORMATION

INTRODUCTION

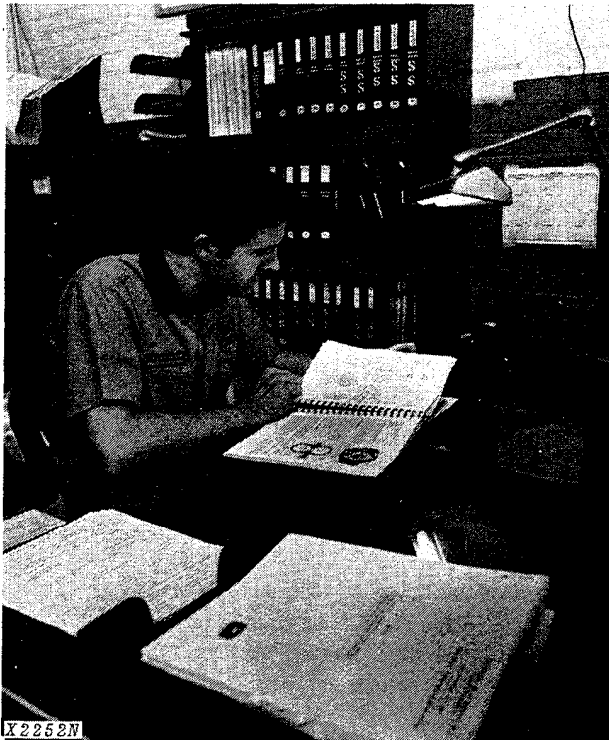

Use FOS Manuals for Reference

This technical manual is part of a twin concept of service:

The two kinds of manuals work as a team to give you both the general background and technical details of shop service.

•FOS Manuals—for reference

Fundamentals of Service (FOS) Manuals cover basic theory of operation, *fundamentals* of trouble shooting, *general* maintenance, and *basic* types of failure and their causes. FOS Manuals are for training new personnel and for reference by experienced service technicians.



When a service technician should refer to a FOS Manual for more information, a FOS symbol like the one at the left is used in the TM to identify the reference.

•Technical Manuals—for actual service

Technical Manuals are concise service guides for a specific machine. Technical manuals are on-the-job guides containing only the vital information needed by an experienced service technician.

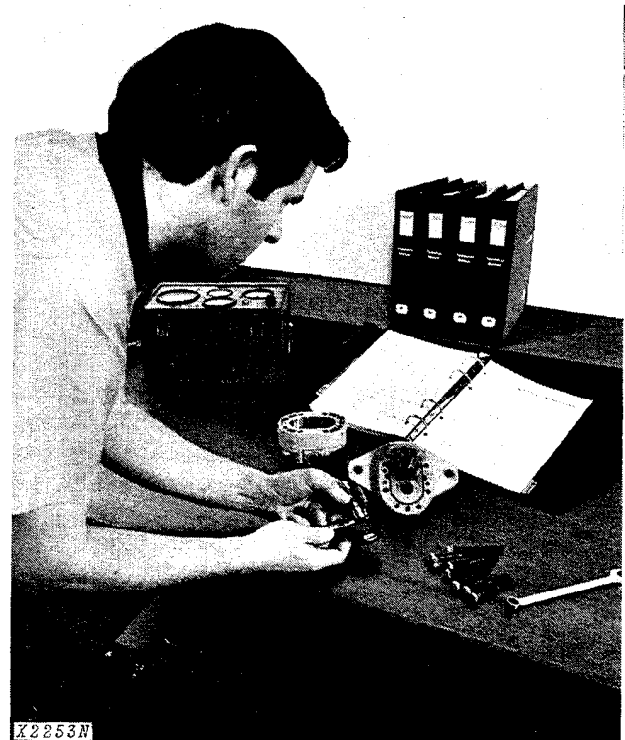

Use Technical Manuals for Actual Service

This technical manual was planned and written for you—an experienced service technician. Keep it in a permanent binder in the shop where it is handy. Refer to it whenever in doubt about correct service procedures or specifications.

Some features of this manual:

- Inside front cover - "Table of Contents".
- Section I - General specifications and services.
- Sections 1 through 42 - Removal, repair, testing (components removed), installation, and adjustment.
- Section 90 - Detailed explanation of system operation, diagnosis, visual inspection, testing, and adjustments.
- Specifications grouped and illustrated at the end of each section.

MAINTENANCE WITHOUT ACCIDENT WORK SAFELY



T27999N

 This safety alert symbol identifies important safety messages in this manual and on the motor grader. When you see this symbol, be alert to the possibility of personal injury and carefully read the message that follows.

**EVERY EMPLOYER HAS A
SAFETY PROGRAM. KNOW
WHAT IT IS!**

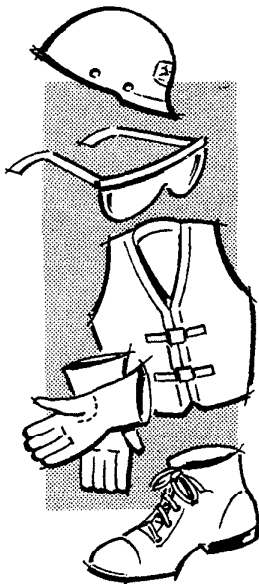

T27501N

Consult your shop foreman for specific instructions on a job, and the safety equipment required.

For instance, you may need: Hard hat, safety shoes, safety goggles, heavy gloves, reflector vests, ear protectors, respirators.

Litho in U.S.A.



T27502N

BE ALERT!

Plan ahead—work safely—know how to use a first-aid kit and a fire extinguisher—and where to get aid and assistance.

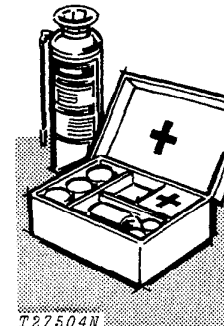

T27504N

Maintenance Area

Make sure the maintenance area is adequately vented.

Keep maintenance area **CLEAN AND DRY**. Oily and wet floors are slippery; greasy rags are a fire hazard; wet spots are dangerous when working with electrical equipment.

Store starting aids in a cool and well-ventilated place, out of the reach of unauthorized personnel.

MAINTENANCE WITHOUT ACCIDENT

AVOID FIRE HAZARDS—

Fuel Is Dangerous!

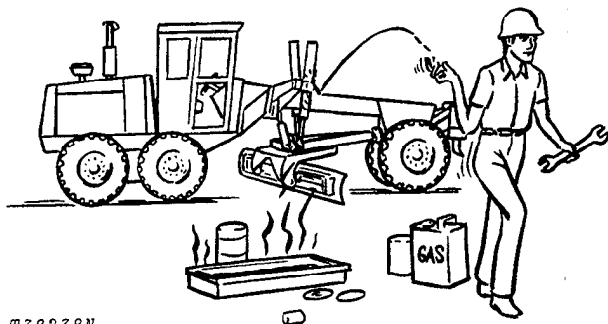

T38238N

Don't smoke while refueling.

Don't smoke while handling highly flammable material.

Engine should be shut off when refueling.

Use care in refueling if the engine is hot.

Don't use open pans of gasoline or diesel fuel for cleaning parts. Good commercial, nonflammable solvents are preferred.

Battery Gas Is Highly Flammable!

Provide adequate ventilation when charging batteries.



T27506N

Don't check battery charge by placing metal objects across the posts.

Don't allow sparks or open flame near batteries.

Don't smoke near battery.

Flame Is Not a Flashlight!

NEVER USE OPEN FLAME AROUND THE MACHINE.

KNOW WHERE FIRE EXTINGUISHERS ARE KEPT!

UNDER ALL MAINTENANCE CONDITIONS—

Do not perform any work on the equipment unless authorized to do so. Then be sure you know the safe and proper procedure.

Follow recommended procedures.

Never service the equipment while it is being operated.

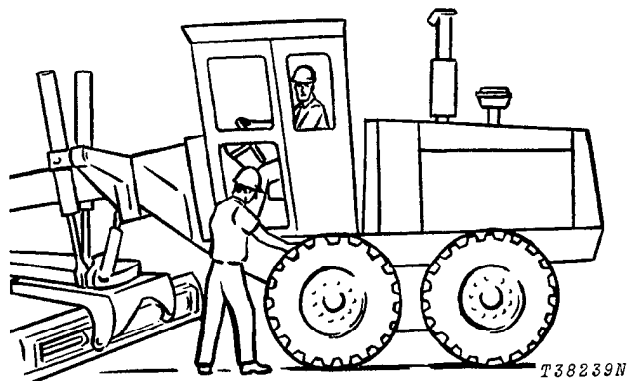

T38239N

Avoid working on equipment with the engine running.

If it is necessary to make checks with the engine running, **ALWAYS USE TWO** service technicians—one, the operator, at the controls, the other checking within sight of the operator.

KEEP HANDS AWAY FROM MOVING PARTS

Support all raised equipment.

Never work under raised blade, ripper, or scarifier.

Lower all equipment to ground.

If the machine is on an incline, block it securely.

Use hoisting equipment for lifting heavy parts.

TAKE CARE! WATCH OUT FOR OTHER PEOPLE IN THE VICINITY

Wear safety glasses when drilling, grinding, or hammering metal.

SERVICING PRECAUTIONS

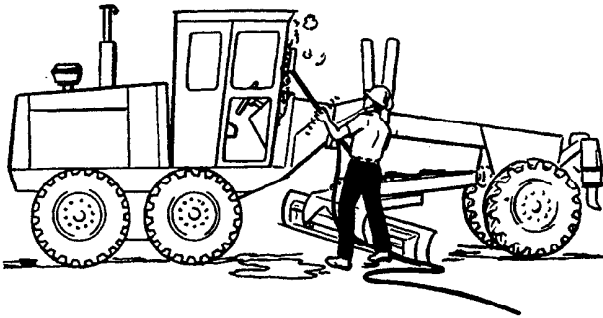

T38242N

Keep ALL equipment free of dirt and oil.

Be sure to clean any oil, grease, mud, ice, or snow from floor of operator's compartment, stepping points, and grab rails.

When preparing the engine for storage, remember that inhibitor is volatile and therefore dangerous. Seal and tape openings after adding the inhibitor. Keep container tightly closed when not in use.

Don't remove the radiator cap until coolant temperature is below the boiling point. Then turn cap slightly to relieve pressure before removing.

Periodically check exhaust system for excessive leakage.

Relieve hydraulic pressure before working on hydraulic system: shut off engine, lower all equipment to ground, and move control levers until no response is felt.

When checking hydraulic pressure, be sure to use the correct test gauge.

PRECAUTIONS DURING REPAIR

Before working on hydraulic system relieve hydraulic pressure.

Before repairing the electrical system, or performing a major overhaul, disconnect batteries.

KNOW EQUIPMENT IS READY!

Check guards, safety bars—all protective devices installed on the grader. Every one should be in place and secure.

CHECK IT OUT!

- GUARDS
- SHIELDS
- PROTECTIVE DEVICES
- SEAT BELTS, ETC.

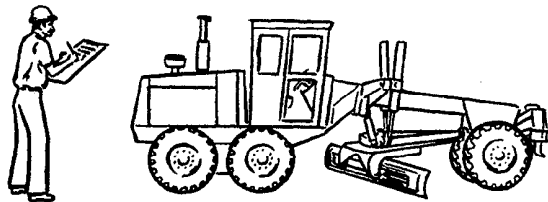

T38243N

Carefully inspect equipment for visual defects—leaks in fuel, lubrication, and hydraulic systems. Do not search for pressurized fluid leaks with your hands. Use cardboard or wood to search for leaks.

Group III

GENERAL SPECIFICATIONS

(Specifications and design subject to change without notice. Wherever applicable, specifications are in accordance with ICED and SAE Standards. Except where otherwise noted, these specifications are based on a unit equipped with 13.00-24, 10-ply-rating, tubeless tires, 13-ft. (3.96 m) moldboard, and standard equipment.

Power (@ 2200 engine rpm):	SAE	
Gross	152 (113.5 kW*)	
Net	142 (106 kW*)	144 PS

*Net engine flywheel power is for an engine equipped with fan, air cleaner, water pump, lubricating-oil pump, fuel pump, alternator, and muffler. Gross engine power is without fan. Flywheel power ratings are under SAE standard conditions of 500 ft. (150 m) altitude and 85° F (20°C) temperature and DIN 70 020 conditions (non-corrected). No derating is required up to 10,000 ft. (3 000 m)

*In the international system of units (SI), power is expressed in kilowatts (kW).

- Engine: John Deere Turbocharged diesel, vertical 6-cylinder, valve-in-head, 4-stroke cycle.
- Bore and stroke .. 4.75 x 5.00 in. (120.6 x 127 mm)
- Piston displacement 531 cu. in (8 702 cm³)
- Compression ratio 15.8 to 1
- Maximum torque
@ 1,400 rpm 440 lb-ft (597 Nm)
- NACC or AMA (U.S. Tax) horsepower 54.15
- Main bearings..... 7
- Lubrication..... Pressure system with full-flow filter
- Cooling Pressurized with thermostat and fixed bypass
- Fan Suction
- Air cleaner with restriction indicator..... Dry
- Electrical system 24 volt (24 V) with alternator
- Batteries (2) Reserve capacity: 360 minutes
- Transmission..... Power Shift, 8 forward and 4 reverse selections
- Differential Lock.....Foot-operated, hydraulically-actuated
- Final Drives.....Inboard planetary

Travel Speeds (2,200 engine rpm, no tire slip, 14.00 - 24 tires)

Shift Lever Position		mph	km/h
Forward	1	2.3	3.7
	2	3.3	5.3
	3	5.2	8.9
	4	6.7	10.8
	5	8.8	14.2
	6	11.5	18.5
	7	14.6	23.6
	8	25.1	40.4
Reverse	1	3.0	4.8
	2	4.2	6.8
	3	6.6	10.6
	4	8.6	13.9

- Brakes:
- ServiceFoot-operated, hydraulically-actuated, wet-disk, effective on 4 tandem wheels
- Parking Foot-operated, mechanical, dry-disk effective on 4 tandem wheels

- Steering:
- Front Full hydraulic power system
- Rear Hydraulically-articulated frame steering (25 deg. left or right)
- Turning radius 22 ft. (6.7 m)
- Range..... 47.5 deg. left or right

- Hydraulic System: Closed-center
- Pressure..... 2,000 psi (138 bar)
- Pressure (stand-by)..... 2,350 psi (162 bar)
- Pump Variable-displacement, 57 gpm (216 L/min. @ 2,200 engine rpm)

- Circle: Welded angle, 5 ft. (1.5 m) dia.
- Rotation 360 deg.
- Drive Hydraulic motor and worm gear

- Drawbar Welded box, 3.5x7x0.5 in. (89x178x13 mm) wall, w/ball and socket pivot

Blade:	Standard	Optional
Length	13 ft. (3.96 m)	12 ft. (3.66 m)
Height	24 in. (610 mm)	24 in. (610 mm)
Thickness	0.88 in. (22 mm)	0.88 in. (22 mm)

Blade Lifting Mechanism:
 Control Dual lever, hydraulic
 Cylinders (2) 3.5 in. (89 mm) dia. bore;
 49 in. (1.25 m) stroke

Blade Range:
 Lift above ground 17 in. (432 mm)
 Blade side-shift:
 Right or left 26.9 in. (683 mm)
 Shoulder reach outside wheels:
 Right 92.5 in. (2 350 mm)
 Left 92 in. (2 337 mm)
 Pitch 35 deg. total

Lift arms:
 Positions 7
 Control Hydraulic, foot operated

Frame:
 Rear main frame Flanged box section from
 articulation joint to main frame arch
 Top and bottom plate,
 width 14 in. (356 mm)
 thickness 0.875 in. (22 mm)
 Side plates, minimum height. . 10.25 in. (260 mm)
 thickness . 0.50 in. (13 mm)
 Weight per ft., min. 112 lb. (51 kg)
 Minimum vertical-section
 modulus. 127 inches cubed
 (323 cm cubed)

Front main frame. Formed box section from main
 frame arch to front hood
 Width. 10 in. (254 mm)
 Height, min. 13 in. (330 mm)
 Thickness 0.625 in. (16 mm)
 Weight per ft., min. 92.3 lb. (42 kg)
 Minimum vertical section
 modulus. 100 inches cubed
 (254 cm cubed)

Tandems: Welded steel box section 2 ft. 3 in. (686
 mm) x 7.56 in. (192 mm)
 Drive 2.00 in. (51 mm) pitch roller chain
 Axle dia. at bearings 3.63 in. (92.2 mm)
 3.35 in. (85.1 mm)

Front Axle: Fabricated steel box frame with steel
 spindles, tapered roller bearings
 Diameter at bearing seats 3.5 in. (90 mm)
 1.87 in. (48 mm)
 Total oscillation 30 deg.
 Wheel lean (either direction) 20 deg.

Rear Drive Axle: Full floating with tapered roller bear-
 ings
 Diameter at bearings 3.63 in. (92.2 mm)

Tires 13.00 - 24, 10 and 12 ply-rating
 8 in. (203 mm) rim
 14.00 - 24, 8, 10 and 12 ply-rating
 8 or 10 in. (203 or 254 mm) rim
 17.5 - 25 and 12 ply-rating
 14 in. (356 mm) rim

Scarifier (Special Equipment): V-type for 4 ft. (1.22 m)
 cut with 3 manual pitch positions
 Number of teeth 5 (standard), 9 (possible)
 Lift above ground 22 in. (559 mm)
 Penetration 12 in. (305 mm)
 Shank size 1.25x4.0 in. (31.7x102 mm)

Ripper (Special Equipment): 8 ft. (2.44 m) cut width,
 parallelogram linkage, 2 manual shank vertical posi-
 tions.
 Number of shank pockets 5
 Number of shanks 3
 Lift above ground 14.5 in. (368 mm)
 Penetration 14 in. (356 mm)
 Shank size 2x5 in. (51x127 mm)
 Lift above ground
 (shank in upper position) 23.5 in. (597 mm)

Capacities:	U.S.	Litres
Fuel tank	70 gal.	265
Cooling system	10 gal.	37.8
Engine lubrication, including filter	22 qt.	21
*Transmission-hydraulic system	31 gal.	117
Tandem housings (each).....	4 gal.	15
Worm gearbox	3 qt.	2.8

SAE			
Operating	On Front	On Rear	Total
Weight	Wheels	Wheels	
Standard	8,220 lb.	21,625 lb.	29,845 lb.
equipment	(3 729 kg)	(9 809 kg)	(13 538 kg)

Standard equipment, and	9,434 lb.	21,626 lb.	31,059 lb.
scarifier	(4 279 kg)	(9 809 kg)	(14 038 kg)

Standard equipment, scarifier	8,637 lb.	24,922 lb.	15,222 lb.
and ripper . . .	(3 918 kg)	(11 304 kg)	(6 905 kg)

*Includes approximately 8 gal. (30 L) for hydraulic
 cylinders, lines, filters, etc.

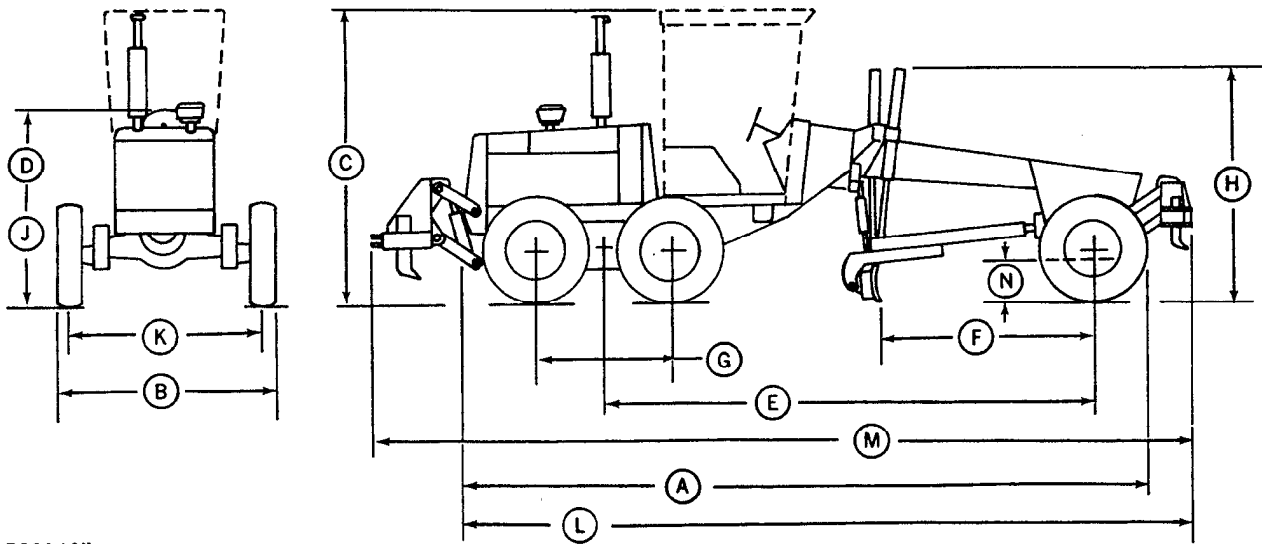

T38246N

OVER-ALL DIMENSIONS

- A. Length 27 ft. 9.5 in. (8.47 m)
- B. Width (13.00 - 24 tires)
 (Front and rear) 7 ft. 10 in. (2.38 m)
- Width (17.5 - 25 tires)
 (Front and rear) 8 ft. 6 in. (2.59 m)
- Width (14.00 - 24 tires)
 (Front and rear) 8 ft. (2.44 m)
- C. Height (with Cab) 10 ft. 6 in. (3.2 m)
- D. Height (w/o Cab - To Top of
 Steering Wheel) 90 in. (2.3 m)
- E. Wheel Base 19 ft. 7 in. (5.97 m)
- F. Blade Base 8 ft. 11 in. (2.72 m)
- G. Tandems (Center Line) 5 ft. 0.7 ft. (1.54 m)
- H. Height (Top Lift Cylinders) ... 9 ft. 7 in. (2.92 m)
- J. Height (Top Air Cleaner) 96 in. (2.4 m)

OVER-ALL DIMENSIONS

- K. Tread
 (Front) (13.00 - 24 tires) 76.6 in. (1.94 m)
- (Front) (17.5 - 25 tires) 79.36 in. (2.01 m)
- (Front) (14.00 - 24 tires) 76.6 in. (1.94 m)
- (Rear) (13.00 - 24 tires) 79.61 in. (2.02 m)
- (Rear) (17.5 - 25 tires) 82.37 in. (2.09 m)
- (Rear) (14.00 - 24 tires) 79.61 in. (2.02 m)
- L. Length with Scarifier (In Up
 Position) 29 ft. 9 in. (9.07 m)
- M. Length with Scarifier and
 Ripper (Both in Up
 Position) 32 ft. 1 in. (9.78 m)
- N. Front axle ground clearance
 with 13.00 - 24 tires 22 in. (559 mm)
- with 17.5 - 25 tires 23.2 in. (589 mm)
- with 14.00 - 24 tires 22.5 in. (571 mm)

Additional Standard Equipment:

- | | |
|---|---|
| Transistorized voltage regulator | Gauges: |
| Lights (2 white front with stop and tail-light) | Water temperature |
| Cigaret lighter | Transmission temperature |
| Horn | Transmission pressure |
| Deluxe bucket seat | Engine-oil pressure |
| Front windshield wiper | Transmission lube |
| Floor mat | Fuel |
| Engine side shields | Pre-cleaner |
| Horn | ROPS with cab and seat belt |
| Turn signals | Air filter indicator |
| Mechanical hour meter | Rear windshield wiper |
| Cold weather starting aid | Work lights (2 front and 2 rear floods) |

Special Equipment:

- | | |
|--|---|
| Scarifier | Heavy-duty batteries (2)
(620 min. reserve capacity) |
| Cab heater | Coolant heater |
| Cab defroster fan | Bench seat |
| ROPS canopy with seat belt | 2 ft. (610 mm) moldboard extensions, right or left |
| Rear mounted ripper with drawbar hitch | 13 ft. (3.96 m) moldboard |
| Below-cab blade lights | 14 ft. (4.27 m) moldboard |
| Reverse warning system | Engine disconnect |
| 3-in. seat belt | Overlay end bits |
| Articulation indicator | Transmission bottom guard |
| | Drawbar hitch |
| | Tool box |
| | Sound-baffled engine side shields |

Group IV

PREDELIVERY, DELIVERY, AND AFTER-SALE SERVICES

TEMPORARY UNIT STORAGE

After receiving your unit from the factory and before putting the machine into temporary storage, perform the following checks.

For long term storage information, consult your JD770 Operator's Manual.

1. Check battery electrolyte level and charge the battery, if necessary.
2. Check coolant level in the radiator. The coolant should be maintained at a level 4 inches (102 mm) below the top of the filler neck.
3. Fill the fuel tank.
4. Check crankcase oil level. Oil should be above bottom mark of dipstick after machine has been shut down for 10 minutes.
5. Relieve hydraulic pressure by lowering blade and stopping engine. Operate brake pedals until hydraulic pressure is bled.
6. Reduce shipping pressure of all tires to inflation pressure, shown on page I-IV-9.
7. Cover unit for protection and cleanliness.

PREDELIVERY SERVICE

Because of the shipping factors involved, plus extra finishing touches that are necessary to promote customer satisfaction, proper predelivery service is of prime importance to the dealer and the customer.

Use the following list when preparing a unit for delivery to the customer.

1. Pre-Cleaner

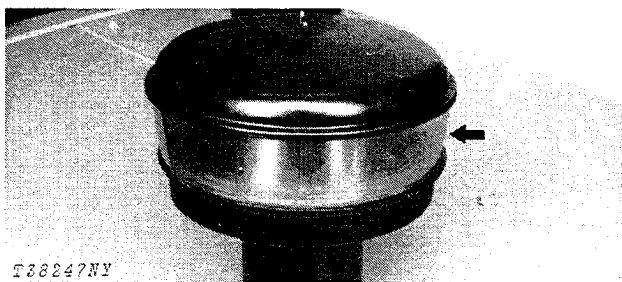

Fig. 1-Pre-Cleaner

Check and clean pre-cleaner bowl.

Pre-cleaner checked and cleaned Yes No

2. Air Cleaner

Check air cleaner restriction indicator on instrument panel. If indicator shows red, check and clean primary element. Install new elements, if necessary.

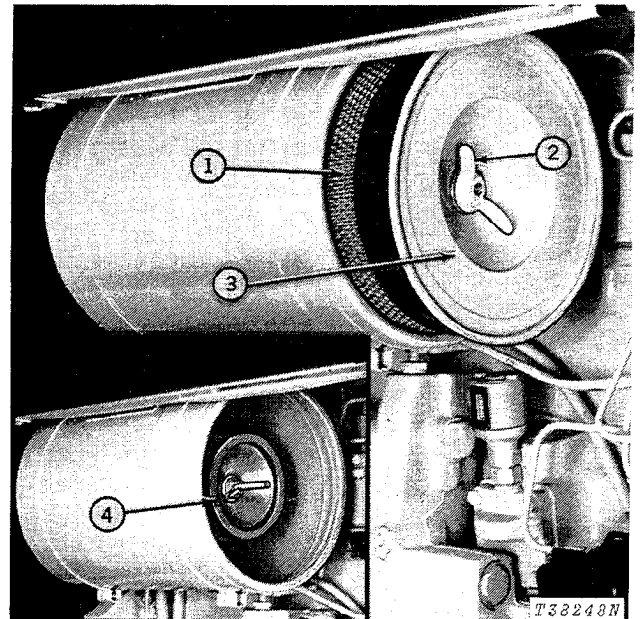

1—Primary Element
 2—Wing Nut

3—Air Cleaner Cover
 4—Safety Element

Fig. 2-Air Cleaner

Air cleaner checked	Yes	No
New elements installed	Yes	No

3. Fuel Filters

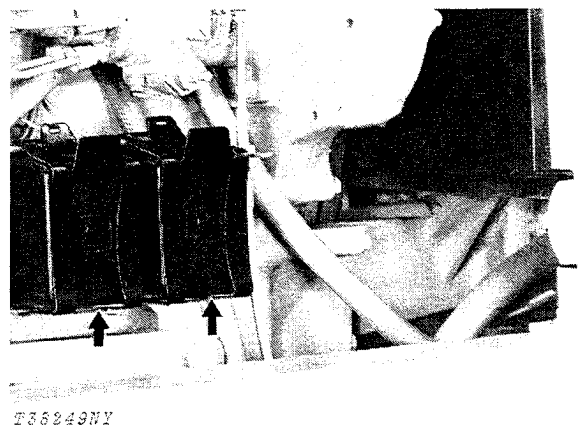

Fig. 3-Fuel Filters

Check fuel filters for sediment. Drain if necessary.

Sediment present in filters	Yes	No
-----------------------------	-----	----

4. Batteries

Check battery electrolyte level. If distilled water is not available, use clean soft water. Avoid use of hard water. Remove foreign material from top of battery and coat terminals with petroleum jelly. Clean vent holes in battery caps.

IMPORTANT: Never add water to battery in freezing weather unless engine will be run 2 to 3 hours.

Check battery connection.
 Punch date code on battery.

Battery connections checked	Yes	No
Water added	Yes	No

5. Fuel Tank

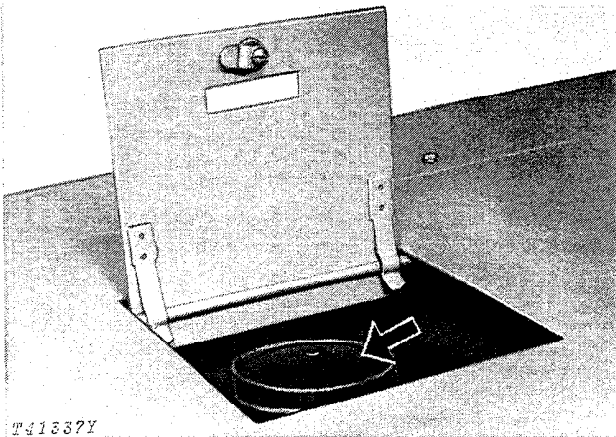

Fig. 4-Fuel Tank Filler Cap

Fill the fuel tank. Check fuel gauge. Fuel tank capacity is 70 U.S. gals. (265 L).

Fuel tank filled	Yes	No
Fuel gauge checked	Yes	No

6. Fuel Tank Sump

IMPORTANT: Sediment will settle over extended periods of transport or storage.

Open the fuel tank drain cock. Allow fuel to drain out for approximately three seconds.

NOTE: Fuel tank sump drain is located on the bottom of the fuel tank. A plastic hose is attached to drain cock to assist in draining tank.

Fuel sump drained	Yes	No
-------------------	-----	----

7. Radiator

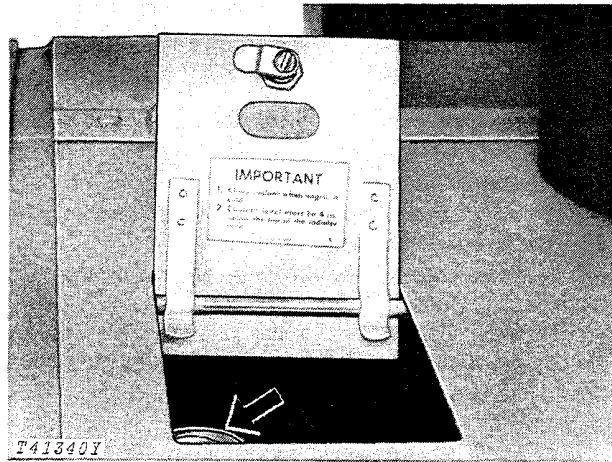

Fig. 5-Radiator Filler Cap

Check the level of coolant in the radiator. Coolant must be 4 inches (102 mm) below the top of the filler neck. Add permanent type antifreeze for cold weather.

CAUTION: Remove the radiator filler cap only when the coolant temperature is below the boiling point. Then loosen the cap slightly to the stop to relieve pressure before removing the cap completely.

Radiator coolant level checked	Yes	No
Coolant or antifreeze added	_____	qts. (L)

8. Tandem Drives

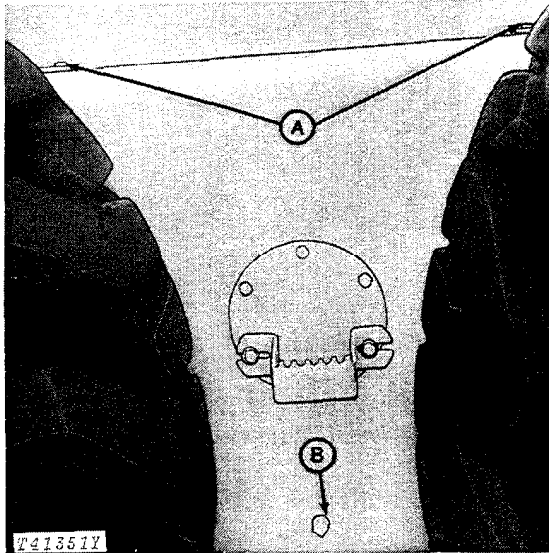

A—Inspection Plates

B—Oil Level Plug

Fig. 6-Tandem Drive

With the grader standing on a level surface and blade on ground, check oil in both tandems by removing oil level plug. Oil must be level with check plug hole. If necessary, add oil specified on page I-V-2 through one of the holes under inspection plate.

Tandem drives oil level checked _____ Yes No
 Oil added _____ qts. (L)

9. Crankcase Oil Level

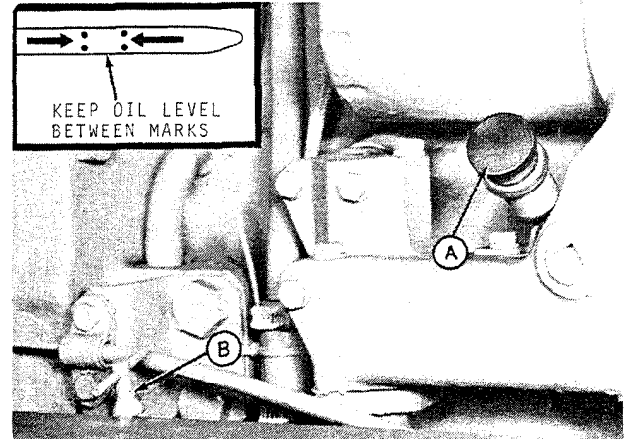

A—Dipstick

B—Oil Filler Cap

Fig. 7-Crankcase Oil Level

Check crankcase oil level with machine on level ground and engine off. If oil level is at or below bottom mark on dipstick, add oil specified on page I-V-2 to bring oil level to between marks on dipstick. Do not operate engine with oil level below the bottom mark.

NOTE: There is 3-1/2 quarts (3.3 L) difference between the bottom mark and the top mark on the dipstick.

Crankcase oil level checked _____ Yes No
 Oil added _____ qts. (L)

10. Circle Drive Gear Box

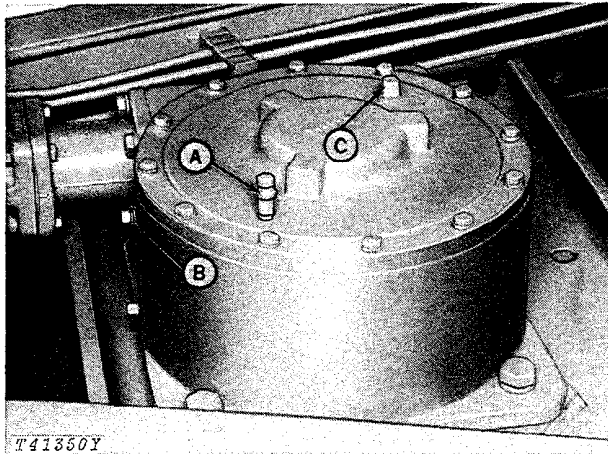

A—Vent B—Oil Level Plug C—Filler Plug

Fig. 8-Circle Drive Gear Box

With the blade resting on level ground, check the circle drive gear box oil level by removing the oil level plug. Oil must be level with the plug hole. If necessary, add oil specified on page I-V-2. Install filler plug.

Circle drive gear box oil level checked Yes No
 Oil added _____ qts. (L)

11. Alternator-Fan Belt Tension

Check the tension on the alternator and fan belts.

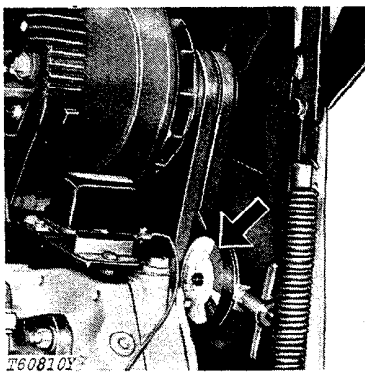

Fig. 9-Strand Tension Gauge

Tension gauge: Immediately after engine shut down (run engine at least 5 minutes), check belt tension. If less than 50 lb. (223 N), allow engine to cool 10 to 15 minutes, then reset tension to 90 lb. (400 N).

NOTE: Check front belt only.

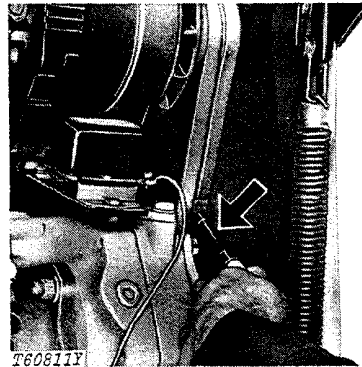

Fig. 10-Gates Tension Tester

Tension tester: Apply 25 lb. (111 N) force midway between pulleys. Belt should deflect 3/4 in. (19 mm).

If adjustment is needed, see page I-IV-23.

Belt tension checked Yes No

12. Check Air Intake Hose

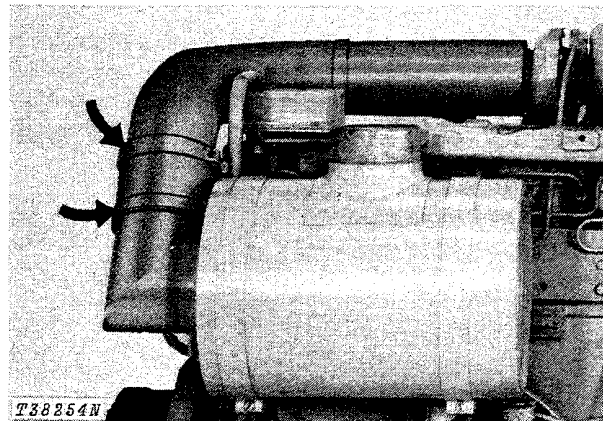
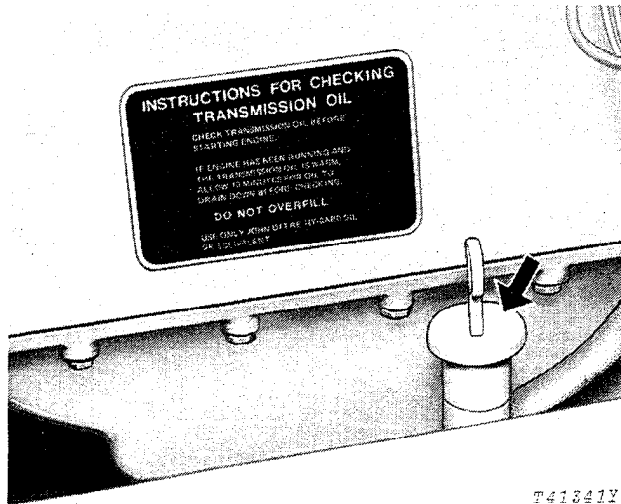

Fig. 11-Air Intake Hose

Check clamps on hose which connect air cleaner and turbocharger tube. Tighten hose clamps where necessary to prevent dirt from entering engine. Inspect hose for cracks.

Air intake hose checked Yes No
 Loose connections Yes No

13. Checking Transmission-Hydraulic System Oil Level



T41341Y

Fig. 12-Transmission-Hydraulic System Filler Cap and Dipstick

Check the transmission-hydraulic system oil level with the dipstick fully inserted in dipstick tube.

Perform the following transmission-hydraulic oil level check: Before starting the engine check the oil level with dipstick. If the oil level is at or near the upper mark, there is sufficient oil in the system to permit starting the engine. If oil level is low, add oil specified on page I-V-2. Install dipstick.

If the engine has been running and the transmission oil is warm, allow 10 minutes for oil to drain down before checking.

Transmission-hydraulic oil level checked Yes No
 Transmission-hydraulic oil added _____qts. (L)

14. Check Engine Speeds

Warm up engine and attach a tachometer in the hour meter drive plug hole to check engine speeds.

No-load, fast idle speed should be 2450 rpm. Slow idle should be 900 rpm.

If engine speeds need adjustment, see page I-IV-23.

Engine speeds checked Yes No

15. Parking Brake

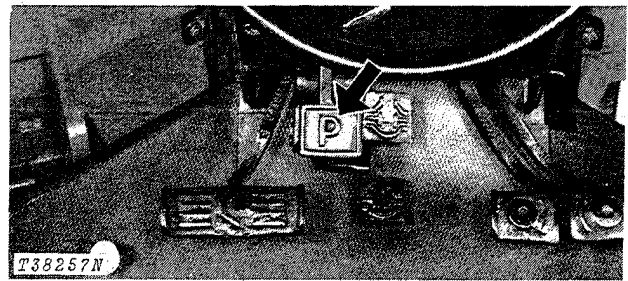

Fig. 13-Parking Brake Pedal

Depress the parking brake pedal with a reasonably heavy force (approximately 150 lbs. [667 N ±]). Remove force from pedal. If the pedal moves upward before it locks, the pedal is traveling beyond the ratchet and needs adjusting. If the pedal is in the lower portion of travel, it should not be adjusted.

To adjust the parking brake, see page I-IV-24.

Parking brake checked Yes No

16. Check Seat Operation

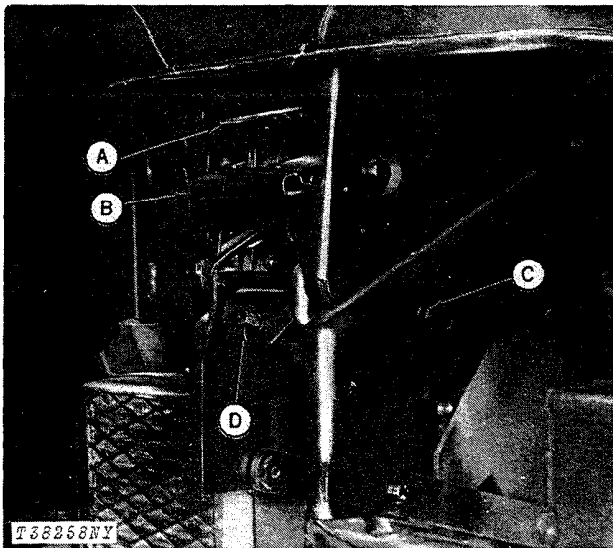

A—Seat Position Selector Lever
 B—Seat Release Catch
 C—Indicator
 D—Weight Adjusting Screw

Fig. 14—Seat Operation

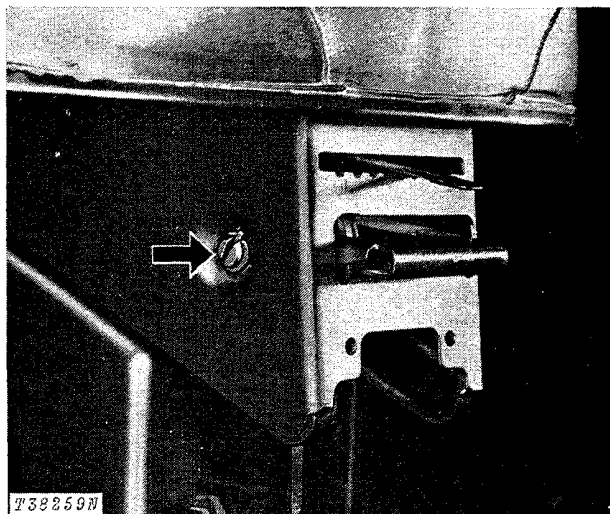

Fig. 15—Seat Counterbalance Shaft

Check the seat adjusting mechanisms denoted in Figures 13 and 14 for easy and correct action.

Seat operation checked Yes No

17. Check Light Operation

Check operation of the following lights.

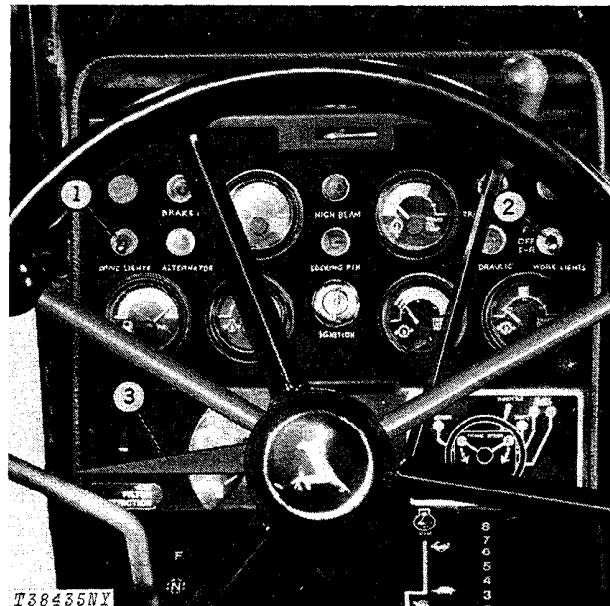

1—Drive Light Switch 3—Turn Light Switch
 2—Work Light Switch

Fig. 16—Light Switches

The drive light switch (1) is on the left side of the instrument panel. With the switch lever in the down position the lights are off; with the switch lever in the up position the drive lights are on. The dimmer switch is located on the left foot rest. When the switch button is pressed, the driving lights change from high beam to low beam or low to high.

The work light switch (2) is located on the right side of the instrument panel. With the switch lever in up or "F" position the front work lights are on, with the lever in the down or "F-R" position the front and rear work lights are on, and with the switch in the center or "OFF" position the work lights are off.

The turn light switch (3) is controlled by a lever near the steering column. When the lever is down the left turn lights flash; when the lever is in the first up from neutral position the right turn lights flash; when the lever is all the way up all the ROPS-mounted warning lights flash; and when the lever is in the "N" position no lights will flash.

All lights checked Yes No

18. Check Transmission Shifting

The grader is equipped with a John Deere Power Shift Transmission. The Power Shift Transmission provides eight forward and four reverse speeds which can be shifted "on the go" or when the grader is stopped by moving the transmission speed selector and direction selector levers to the desired positions.

NOTE: The parking brake must be released before the direction selector lever can be shifted out of neutral.

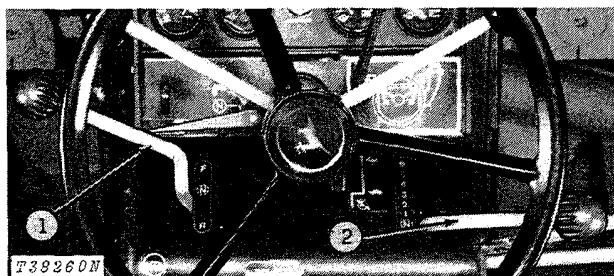

1—Direction Selector Lever
 2—Transmission Speed Selector Lever

Fig. 17-Transmission Controls

Shift transmission through all ranges. If transmission does not respond see Section 3 for repair.

Transmission operational Yes No

19. Reverser Operation

The reverser unit allows the operator to change the direction of travel "on the go" without declutching or shifting gears.

When the direction selector lever is moved forward from neutral, the motor grader will move forward provided the transmission speed selector lever is positioned in a gear.

When the direction selector lever is moved rearward from neutral, the motor grader will move rearward provided the transmission speed selector lever is in the 1-4 gear range. If the transmission speed selector lever is in the 5-8 gear range, the direction selector cannot be moved rearward.

Direction selector lever checked Yes No

20. Indicator Lights and Gauges

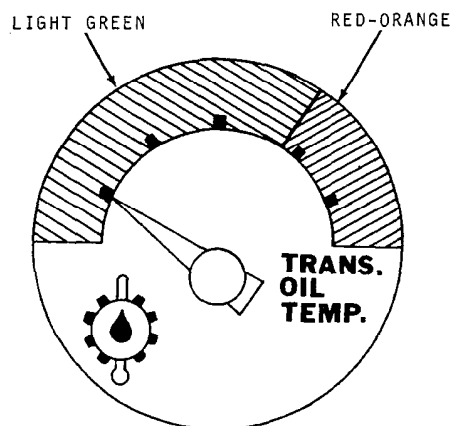

T38261N

Fig. 18-Transmission Oil Temperature Gauge

The transmission temperature gauge indicates the temperature of the lubricating oil in the transmission. If indicator hand enters the red-orange zone, operate in a lower gear or speed. If hand remains in the red-orange zone, check transmission oil level or plugged oil cooler. Do not continue grader operation with hand in the red-orange zone.

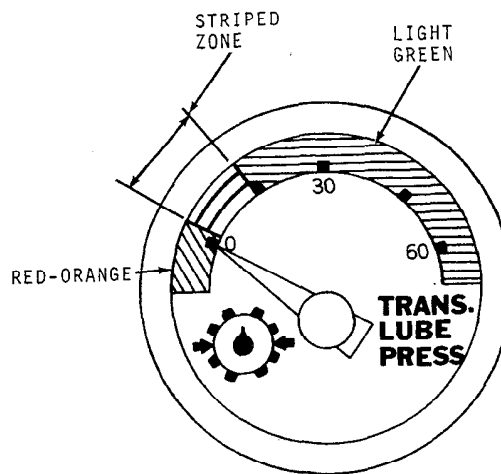

T38262N

Fig. 19-Transmission Lube Pressure Gauge

During normal operations, the indicator hand should be in the light green zone on the dial. When the engine is idling the indicator hand should be in the striped zone.

IMPORTANT: Do not operate the grader if the indicator falls into the red-orange zone.

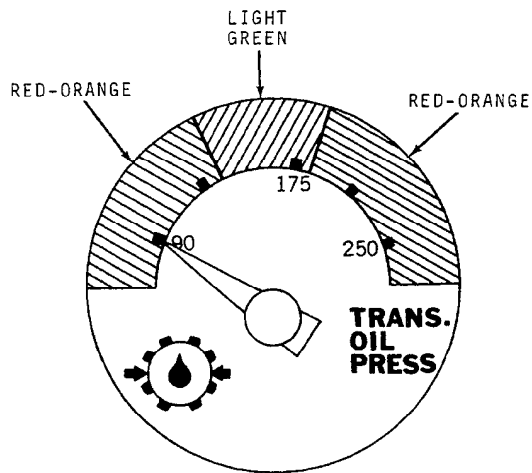

T38263N

Fig. 20-Transmission Oil Pressure Gauge

During normal operations, the indicator hand should be in the light green zone on the dial. If the indicator hand is in the right hand red-orange zone, there is excess pressure in the transmission. If the indicator hand drops into the left red-orange zone, there is low pressure. If hand is in either zone, stop the grader and determine the cause.

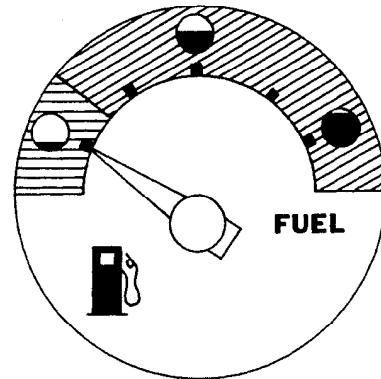

T38264N

Fig. 21-Fuel Gauge

The fuel gauge is used to determine the amount of fuel in the fuel tank.

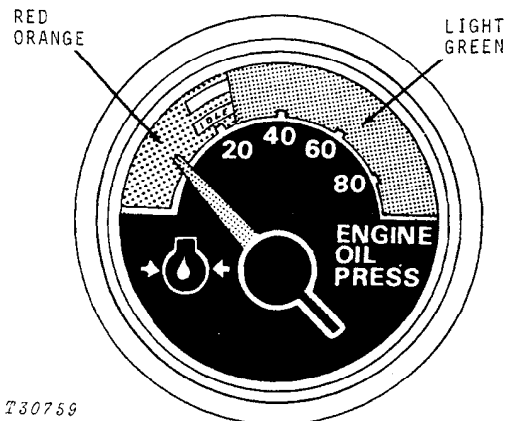

T30759

Fig. 22-Engine Oil Pressure Gauge

During normal operations, the indicator hand should be in the light green zone on the dial. If the indicator hand goes into the red-orange zone, stop the grader and check the engine oil level. If oil level is not low, check for restrictions in oil lines or incorrect viscosity oil.

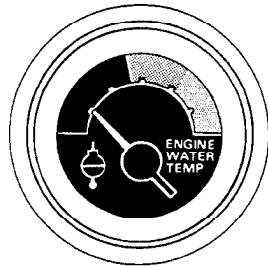

T30897N

Fig. 23-Engine Coolant Temperature Gauge

The engine coolant temperature gauge indicates the coolant temperature in the cooling system. Normal operating temperature is indicated by the light green zone on the dial. If above 224°F (107°C) (indicated by the red-orange zone on the dial), stop engine and determine the cause.

Gauges and indicators operational Yes No

21. Checking Tire Pressure

Check the air pressure in all the tires with an accurate gauge having 1 psi (0.07 bar) graduations.

IMPORTANT: All tires must be inflated to the same pressure.

Adjust pressure in tires to the following specifications:

Tire size	Ply Rating	Inflation Pressures psi (bar)
13.00-24	10	30 (2.07)
13.00-24	12	35 (2.41)
14.00-24	10	30 (2.07)
14.00-24	12	35 (2.41)
17.5-25	12	25 (1.72)

Tire pressure checked Yes No

22. Check Differential Lock Operation

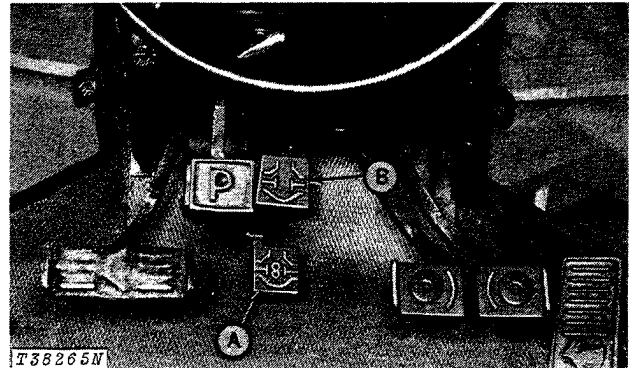

T38265N

A—Engage

B—Disengage

Fig. 24-Differential Lock Pedal

Check differential lock operation.

With the engine off and differential lock engaged, raise one rear wheel off the ground.

Attempt to rotate the wheel manually. If differential lock is functioning correctly, raised wheel will lock in place.

Differential lock checked Yes No

23. Hydraulic Brakes

Check brake operation.

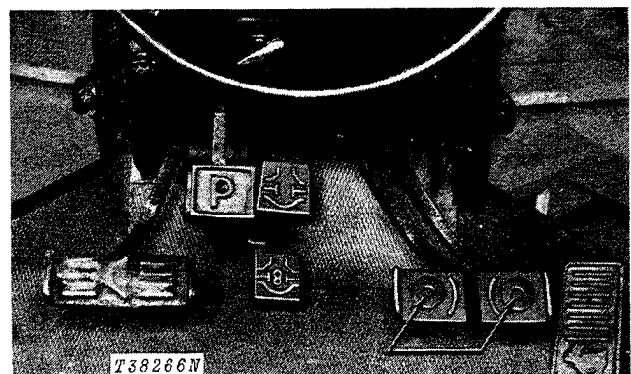

T38266N

Fig. 25-Brake Pedals

Check brake system for leaks or improper operation.

Put grader in gear and depress brake pedal. Moderate pedal force should hold grader in place.

If pedal force does not hold grader in place, pedal feels spongy or bottoms out, repair is required, or system may require bleeding (page I-IV-30).

Brakes operational Yes No

24. Check Blade Lever Operation

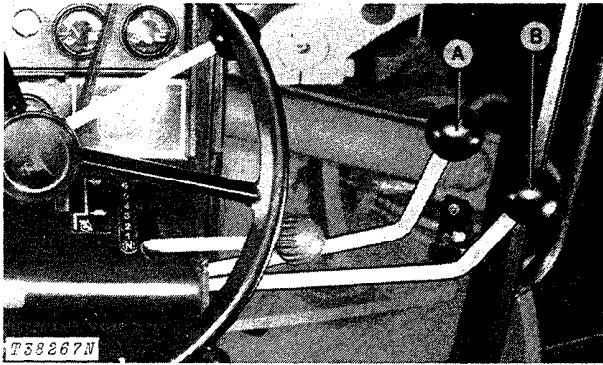

A—Left Blade Lift Lever
 B—Right Blade Lift Lever

Fig. 26-Blade Lift Levers

Move levers A and B forward to lower the blade and rearward to raise the blade. Levers can be operated individually to position the blade at the desired working angle, or operated at the same time to lower the blade to working depth.

Blade lever action checked Yes No

25. Check Clutch Pedal Adjustment

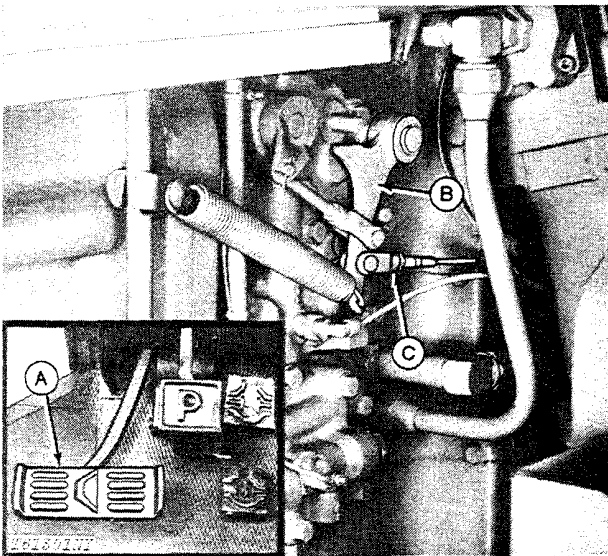

A—Clutch Pedal
 B—Clutch Valve Control Lever
 C—Clutch Cable Yoke

Fig. 27-Clutch Pedal Adjustment

Push down clutch pedal (A) until clutch valve control lever (B) is turned counterclockwise against the stop. The bottom of the clutch pedal must clear the floor plate.

Turn the clutch cable yoke (C) so bottom of clutch pedal clears floor plate.

Clutch pedal adjustment checked Yes No

26. Steering

Start the engine and operate the steering wheel. Steering should be free and easy with engine running.

Steering operational Yes No

27. Check Lubrication

The motor grader was checked and lubricated before it left the factory. However, to insure customer satisfaction, check each lubrication point shown on the following pages. Lubricate with several strokes of John Deere Multi-Purpose Grease, if necessary.

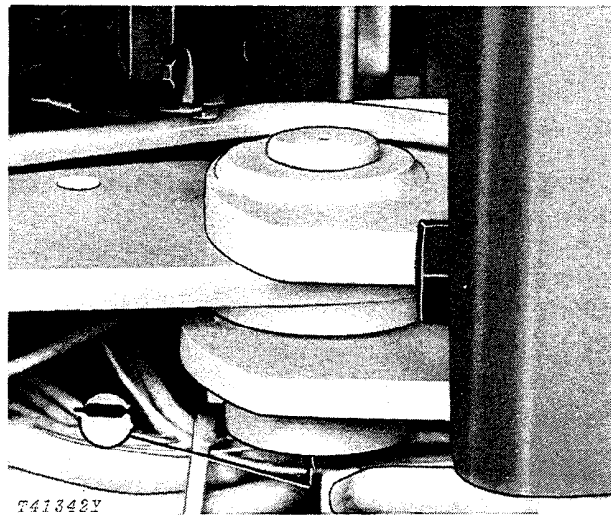

Fig. 28-Frame Pivot (Upper Shown)

Also lubricate the bottom hinge area of the frame pivot. Grease fitting is on the engine frame pivot plate.

Lubricant required Yes No

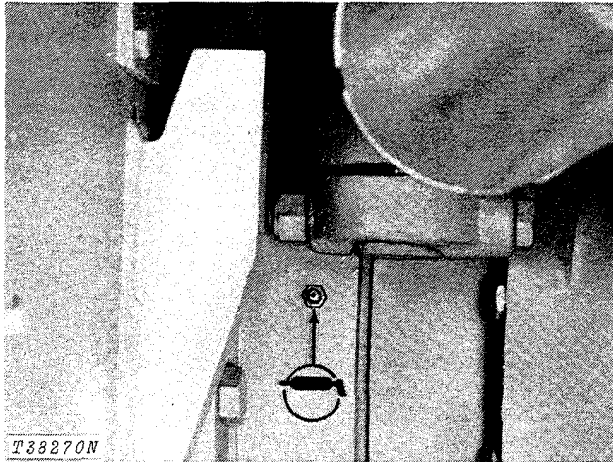

Fig. 29-Tandem Pivot
 (Right side shown)

Fitting shown is on the front of the tandem pivot housing between the final drive housing and the tandem housing.

Lubricant required Yes No

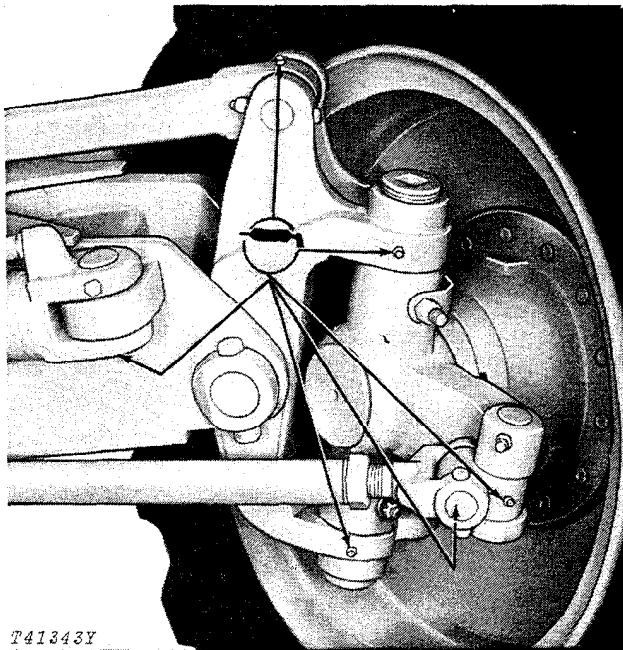

Fig. 30-Front Axle Grease Fittings
 (Right side shown)

Lubricant required Yes No

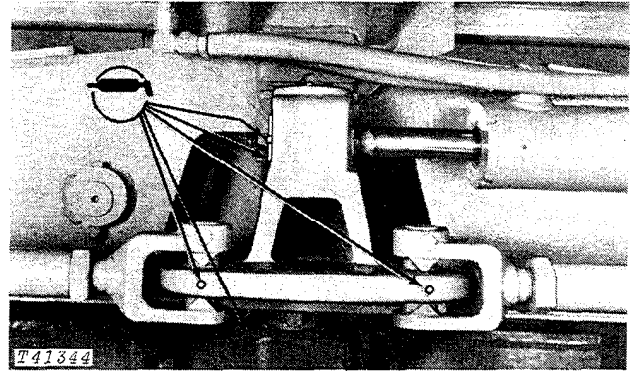
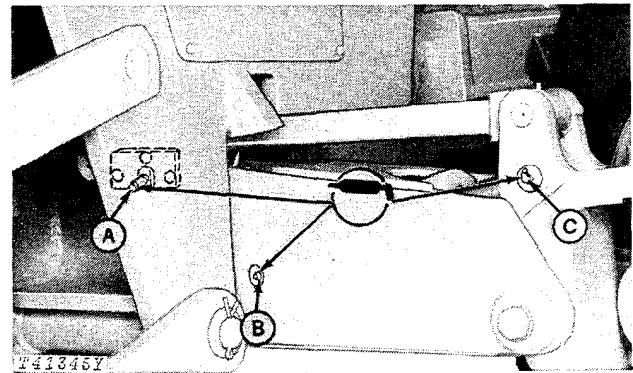

Fig. 31-Steering Yoke and Tie Bars

Lubricant required Yes No



A—Oscillation Pivot
 B and C—Wheel Lean Pivots

Fig. 32-Front Axle Oscillation Pivot
 and Wheel Lean Pivots

NOTE: Lubricate the front axle oscillation pivot at the front fitting as shown and the rear fitting also (not shown).

Lubricant required Yes No

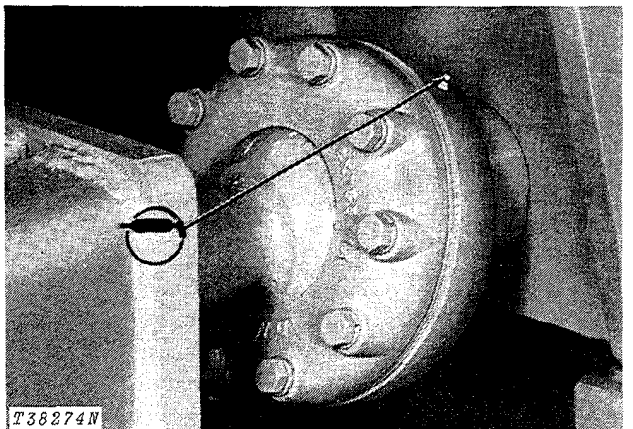

Fig. 33-Draft Ball Pivot

Lubricant required Yes No

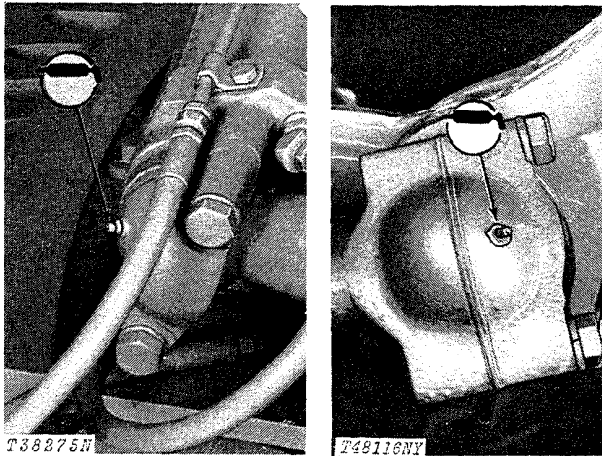

Fig. 34-Circle Side-Shift Cylinder

Lubricant required Yes No

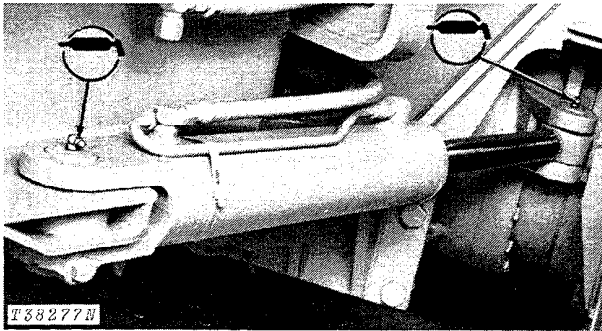

Fig. 35-Steering Cylinder
 (Left side shown)

Lubricant required Yes No

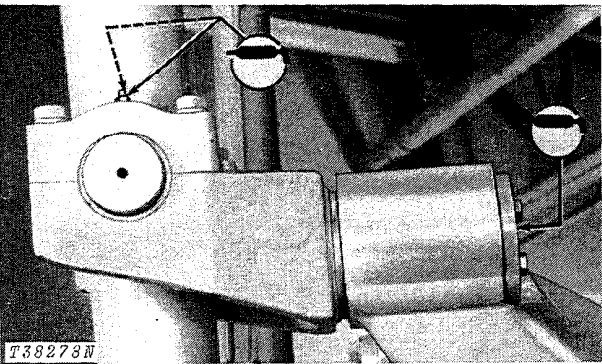

Fig. 36-Lift Cylinder Trunnion
 (Left side shown)

Lubricant required Yes No

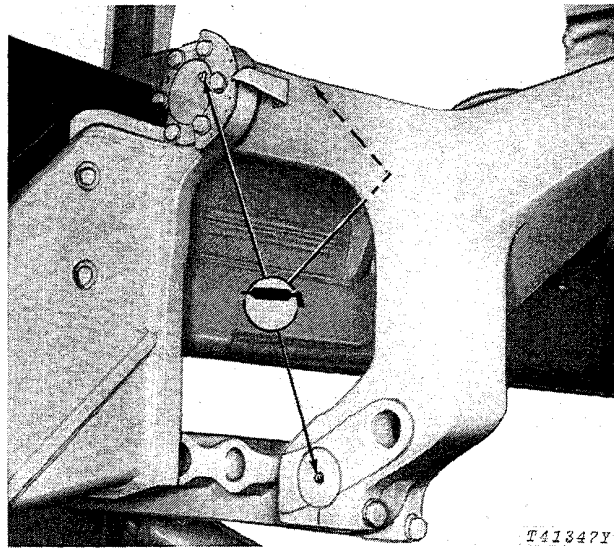

Fig. 37-Lift Arm Pivots
 (Right rear shown)

NOTE: Lubricate the front lift arm pivots indicated above by dotted line.

Lubricant required Yes No

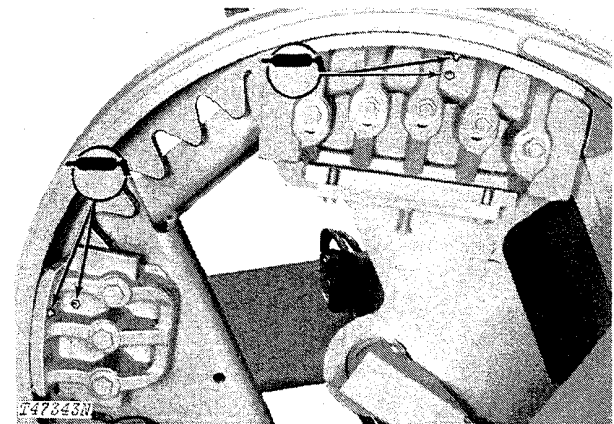

Fig. 38-Circle Wear Area (8 fittings total)

Lubricant required Yes No

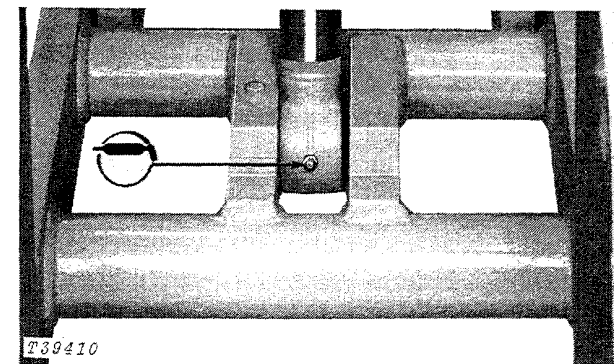
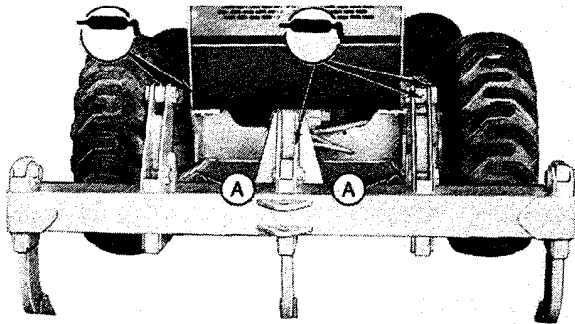

Fig. 39-Scarifier Lift Cylinder-Rod End (if equipped)

Lubricant required Yes No



T41348Y

Fig. 40-Ripper Lubrication (if equipped)

Pivot pins on the ends of both plates marked A. Lower end of lift cylinder. In all, ten points should be lubricated.

Lubricant required Yes No

28. Wheel Retaining Cap Screws

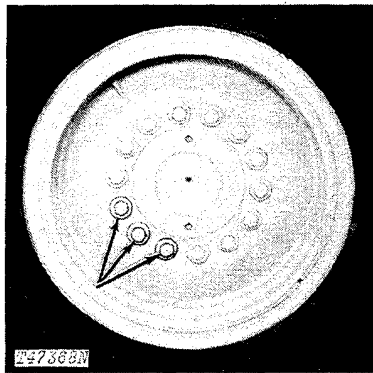

Fig. 41-Wheel Retaining Cap Screws

Check all wheel retainer cap screw torque. Tighten wheel retaining cap screws to 300 lb-ft (407 Nm).

Wheel retaining cap screws tightened Yes No

29. Check Accumulator Action

Check the accumulator reserve capacity as follows:

Start engine and run approximately one minute. Stop engine. Operate brake pedal twenty applications. After twenty applications, pedal travel should not be excessive with a firm but moderate pedal effort if the brake accumulator is functioning correctly.

Accumulator checked Yes No

30. Fluid Leakage

Check the following systems for leakage due to poor or faulty connections and broken hoses or lines.

- A. Cooling system checked Yes No
- B. Hydraulic system checked Yes No
- C. Transmission system checked Yes No
- D. Fuel system checked Yes No

31. Accessible Hardware Torque Values

Check all accessible bolts and nuts for proper tightness. If hardware is loose, tighten it to the proper torque. The table below gives correct torque values for various bolts and cap screws. Most hardware used is high-strength (note dashes on hex. heads).

RECOMMENDED TORQUE IN LB-FT (Nm) COARSE AND FINE THREADS			
	B	D	F
Bolt Diameter	Plain Head	Three Dashes	Six Dashes
1/4	Not used	10 (14)	14 (19)
5/16	Not used	20 (27)	30 (41)
3/8	Not used	35 (47)	50 (68)
7/16	35 (47)	55 (75)	80 (108)
1/2	55 (75)	85 (115)	120 (163)
9/16	75 (102)	130 (176)	175 (237)
5/8	105 (142)	170 (230)	240 (325)
3/4	185 (251)	300 (407)	425 (576)
7/8	160 (217)	445 (603)	685 (929)
1	250 (339)	670 (908)	1030 (1396)
1-1/8	330 (447)	910 (1234)	1460 (1979)
1-1/4	480 (651)	1250 (1695)	2060 (2793)

T41559

Fig. 42-Torque Chart

The types of bolts and cap screws are identified by head markings as follows:

Plain Head: regular machine bolts and cap screws.

3-Dash Head: tempered steel high-strength bolts and cap screws.

6-Dash Head: tempered steel extra high-strength bolts and cap screws.

Machine bolts and cap screws 7/8-inch and larger are sometimes formed hot rather than cold, which accounts for the lower torque.

All accessible hardware torqued Yes No

32. Final Check

The final predelivery procedure is the overall clean-up of the motor grader. Make the motor grader LOOK like a new motor grader with the proper touch-up of chipped paint and a good wash job. Deliver to the customer a motor grader anyone would be proud to own.

DELIVERY SERVICE

A thorough discussion of the operation and service of this new motor grader at the time of delivery helps to assure complete customer satisfaction. Proper delivery should be an important phase of a dealer's program. A portion of the John Deere Delivery Receipt emphasizes the importance of proper delivery service.

Many complaints arise because the owner was not shown how to operate and service the new motor grader properly. Devote enough time, at the customer's convenience, to introduce the owner to the new motor grader and explain how to operate and service it.

The following procedure is recommended before the service technician and owner complete the delivery acknowledgments portion of the Delivery Receipt.

Using the operator's manual as a guide be sure that the owner understands these points thoroughly:

1. The importance of safety.
2. The importance of lubrication and periodic services.
3. The importance of the break-in period.
4. Controls and instruments.
5. How to start and stop the engine.
6. All functions of the hydraulic system.

After explaining and demonstrating the above features, have the owner sign the Delivery Receipt and give the owner the operator's manual.

AFTER-SALE INSPECTION

The purchaser of a new John Deere motor grader is entitled to a free inspection at some mutually agreeable time within the warranty period after the equipment has been "run in," usually after 50 to 100 hours of motor grader operation. The terms of this after-sale inspection are outlined on the customer's John Deere Delivery Receipt.

This inspection is to make sure that the customer is receiving satisfactory performance from motor grader. At the same time, the inspection should reveal whether or not the motor grader is being operated, lubricated, and serviced properly.

If the recommended after-sale service inspection is followed, the dealer can eliminate a needless volume of service work by preventing minor irregularities from developing into serious problems later on. This will promote strong dealer-customer relations and present the dealer an opportunity to answer questions that may have arisen during the first few days of operation.

During the inspection service, the dealer has the further opportunity of promoting the possible sale of other new equipment.

Check operation of all controls and instruments for freedom of movement and correct operation.

1. Engine Crankcase Oil and Filter Element

NOTE: Check with the customer if oil has been changed and filter replaced before performing this service.

Normal sequence of service is as follows:

Oil and filter change - after first 100 hours
 - every 200 hours thereafter

If changed, record information below:

Approximate hours at change _____

If not, change as follows:

- 1 - Run engine to heat oil.
- 2 - Drain oil from engine crankcase.
- 3 - While crankcase is draining, replace filter element as follows.

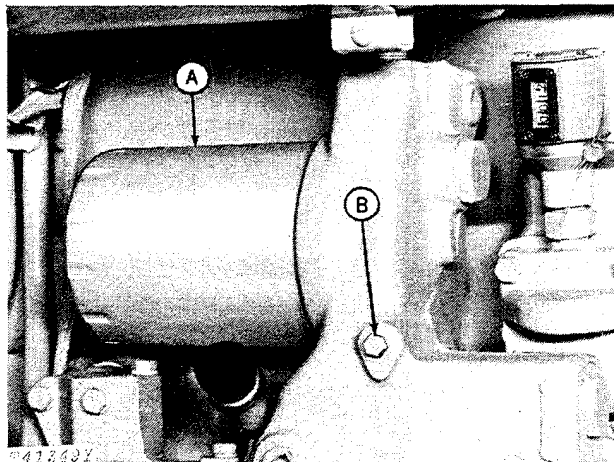

1—Engine Crankcase
 Oil Filter

B—Drain Plug

Fig. 43-Engine Crankcase Oil Filter

- A - Remove drain plug from filter housing.
- B - Remove filter element (turn counterclockwise).

- C - Clean mounting surface.
 - D - Apply film of oil to sealing ring.
 - E - Tighten element until sealing ring touches mounting surface.
 - F - Turn an additional 1/2 to 3/4 turn.
 - G - Do not overtighten.
 - H - Install drain plug in filter housing.
- 4 - Install drain plug in engine crankcase.
 - 5 - Fill crankcase with oil specified on page I-V-2. Capacity is 20 quarts (19 L) without filter, 22 quarts (21 L) with filter.
 - 6 - Run engine a short time and check for leaks at filter base, filter housing drain plug and engine crankcase drain plug. Tighten filter if required.
 - 7 - Stop engine.

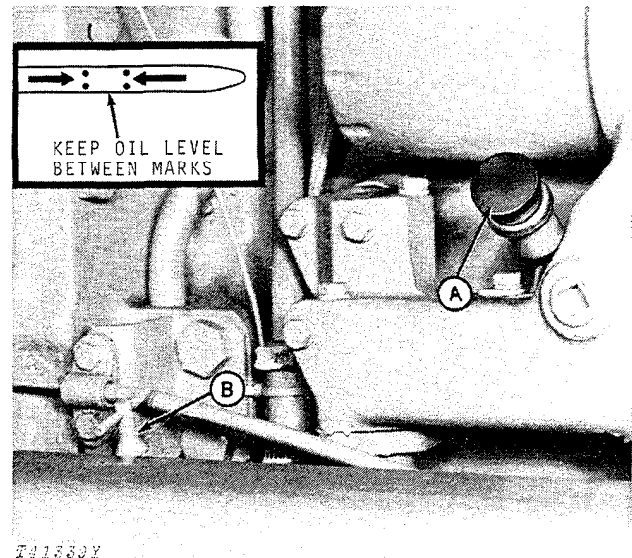

A—Dipstick

B—Oil Filler Cap

Fig. 44-Crankcase Oil Level

- 8 - Check oil level. Level should be at top mark on dipstick while resting on filler tube.

Crankcase oil changed	Yes	No
Oil filter element changed	Yes	No

2. Transmission-Hydraulic System Oil Level and Filter Elements

NOTE: Before checking oil level find out if customer has changed filter elements (first 100 hours service).

If changed at an earlier date, record information below:

Approximate hours at change _____

If not, change as follows:

- 1 - Run engine to heat oil.
- 2 - Remove transmission-hydraulic system drain plugs and transfer drive gear housing plug and drain oil.
- 3 - While transmission is draining, replace the transmission and function return oil filter elements as follows:

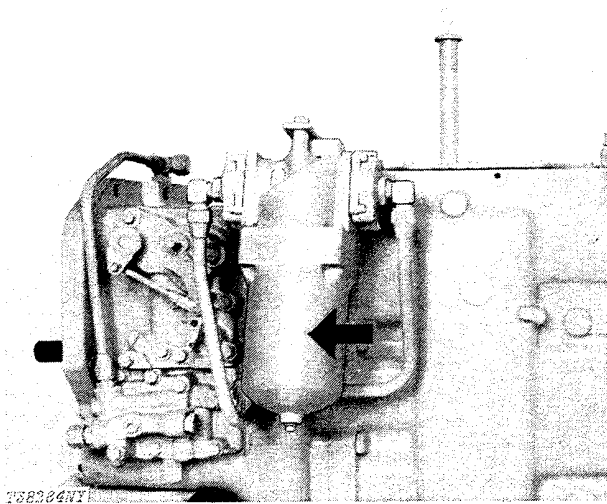

Fig. 45-Transmission Oil Filter

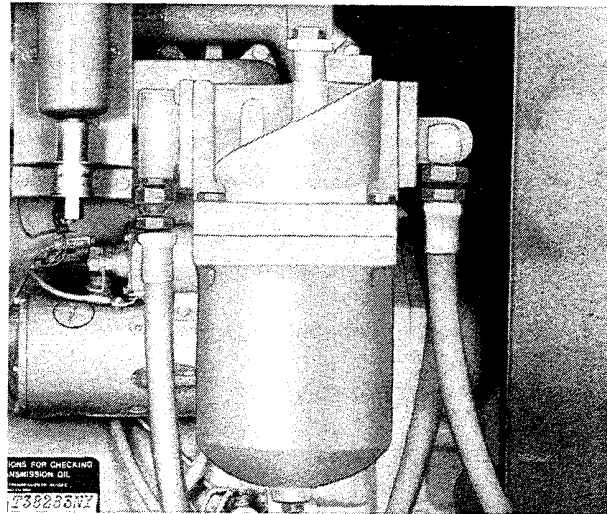

Fig. 46-Function Return Oil Filter

- A - Remove drain plugs from filter housings.
 - B - Open filters slightly to allow oil to drain.
 - C - Remove filter covers.
 - D - Remove packings and elements.
 - E - Install new packings. Be sure they are fully seated.
 - F - Install new elements and filter covers.
- 4 - Install transmission-hydraulic system drain plugs and transfer drive gear housing plug.

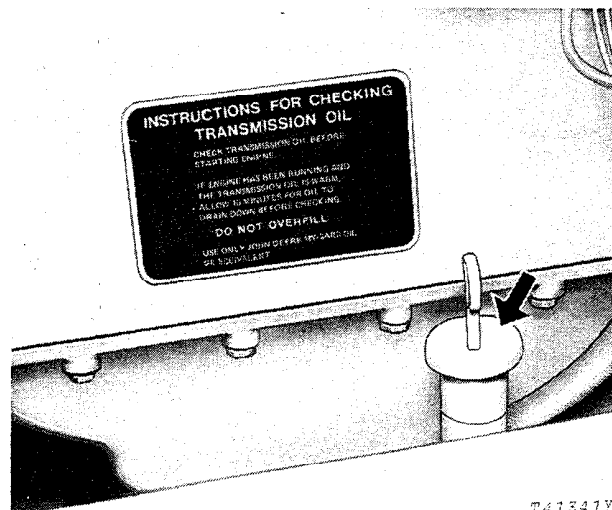

Fig. 47-Transmission-Hydraulic System
Filler Cap and Dipstick



Suggest:

If the above button click is invalid.

Please download this document

first, and then click the above link

to download the complete manual.

Thank you so much for reading

- 5 - Fill transmission-hydraulic system with oil specified on page I-V-2.
- 6 - Run engine a short time and check for leaks at filter bases and drain plugs. Tighten filter covers if required.
- 7 - Stop engine.
- 8 - Check oil level after engine has been shut off a minimum of 10 minutes. Level should be at top mark on dipstick while resting on filler tube.

Oil level checked Yes No

Transmission-hydraulic system oil filter elements replaced Yes No

3. Tandem Drives

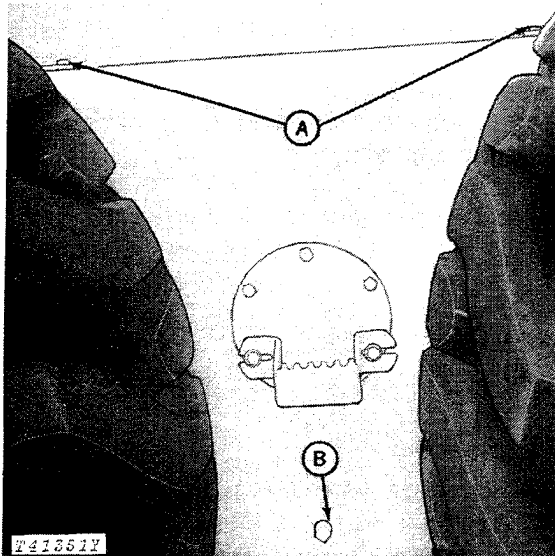

A—Inspection Plates B—Oil Level Plug

Fig. 48-Tandem Drive

With the grader standing on a level surface, check oil in both tandems by removing the oil level plug. Oil must be level with the check plug hole. If necessary, add oil specified on page I-V-2 through one of the holes under inspection plates.

Tandem drives oil level checked Yes No
 Oil added _____ qts. (L)

4. Circle Drive Gear Box

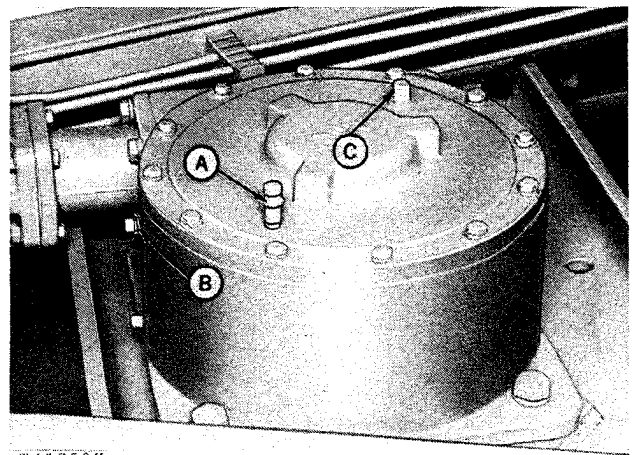

A—Vent C—Filler Plug
 B—Oil Level Plug

Fig. 49-Circle Drive Gear Box

With the draft frame level, check the circle drive gear box oil level by removing the oil level plug. Oil must be level with the plug hole. If necessary, add oil specified on page I-V-2. Filler plug.

Circle drive gear box oil level checked Yes No
 Oil added _____ qts. (L)

<https://www.ebooklibonline.com>

Hello dear friend!

Thank you very much for reading.

Enter the link into your browser.

The full manual is available for immediate download.

<https://www.ebooklibonline.com>