

**John Deere
710B
Backhoe Loader**

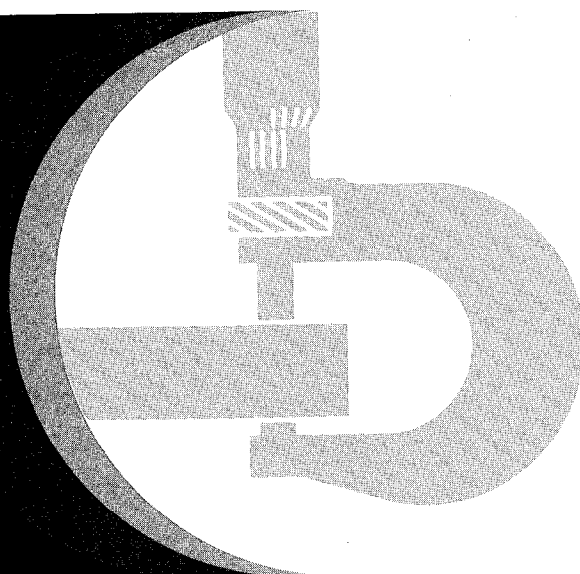

TECHNICAL MANUAL

TM-1286 (Dec-86)

LITHO IN U.S.A.

710B BACKHOE LOADER TECHNICAL MANUAL TM-1286 (DEC-86)

SECTION AND GROUP CONTENTS

SECTION I—GENERAL INFORMATION

- Group I—Introduction and Safety Information
- Group II—General Specifications
- Group III—Torque Values
- Group IV—Lubrication

SECTION 01—WHEELS

- Group 0110—Powered Wheels and Fastenings
- Group 0120—Non-Powered Wheels and Fastenings

SECTION 02—AXLES AND SUSPENSION SYSTEMS

- Group 0200—Removal and Installation
- Group 0210—Differential or Bevel Drive
- Group 0225—Input Drive Shaft and U-Joints
- Group 0230—Non-Powered Wheel Axles
- Group 0240—Powered Wheel Axle (MFWD)
- Group 0250—Axle Shafts, Bearings and Reduction Gears
- Group 0260—Hydraulic System

SECTION 03—TRANSMISSION

- Group 0300—Removal and Installation
- Group 0315—Controls
- Group 0350—Gears, Shafts, Bearings and Power Shift Clutch
- Group 0360—Hydraulic System

SECTION 04—ENGINE

- Group 0400—Removal and Installation
- Group 0401—Crankshaft and Main Bearings

SECTION 04—ENGINE—Continued

- Group 0402—Camshaft and Valve Actuating Means
- Group 0403—Connecting Rods and Pistons
- Group 0404—Cylinder Block
- Group 0407—Oiling System
- Group 0409—Cylinder Head and Valves
- Group 0413—Fuel Injection System
- Group 0414—Intake Manifold
- Group 0416—Turbocharger
- Group 0417—Water Pump
- Group 0418—Thermostats, Housing and Water Piping
- Group 0419—Oil Cooler
- Group 0420—Fuel Filter
- Group 0421—Fuel Transfer Pump
- Group 0422—Starting Motor and Fastenings
- Group 0433—Flywheel, Housing and Fastenings

SECTION 05—ENGINE AUXILIARY SYSTEMS

- Group 0505—Cold Weather Starting Aids
- Group 0510—Cooling Systems
- Group 0515—Speed Controls
- Group 0520—Intake System
- Group 0560—External Fuel Supply Systems

SECTION 07—DAMPENER DRIVE

- Group 0752—Elements

Continued on next page

All information, illustrations and specifications contained in this technical manual are based on the latest information available at the time of publication. The right is reserved to make changes at any time without notice. Wherever applicable, specifications and design information are in accordance with SAE and ICED standards.

Copyright© 1986
DEERE & COMPANY
Moline, Illinois
All Rights Reserved
A JOHN DEERE ILLUSTRATION
Previous Edition
Copyright© 1985 DEERE & COMPANY
Copyright© 1984 DEERE & COMPANY
Copyright© 1983 DEERE & COMPANY

T64;1286 01 231086

SECTION AND GROUP CONTENTS - Continued

SECTION 09 - STEERING SYSTEM

Group 0960 - Hydraulic System

SECTION 10 - SERVICE BRAKES

Group 1011 - Active Elements
Group 1060 - Hydraulic System

SECTION 11 - PARKING-EMERGENCY BRAKES

Group 1111 - Active Elements
Group 1115 - Controls Linkage

SECTION 16 - ELECTRICAL SYSTEMS

Group 1671 - Batteries, Support and Cables
Group 1672 - Alternator, Regulator and Charging System Wiring
Group 1673 - Lighting System
Group 1674 - Wiring Harness and Switches
Group 1676 - Instruments and Indicators

SECTION 17 - FRAME, CHASSIS, OR SUPPORTING STRUCTURE

Group 1740 - Frame Installation
Group 1749 - Chassis Weights

SECTION 18 - OPERATOR'S STATION

Group 1800 - Removal and Installation
Group 1810 - Operator Enclosure
Group 1821 - Seat and Seat Belt
Group 1830 - Heating and Air Conditioning

SECTION 19 - SHEET METAL AND STYLING

Group 1910 - Hood or Engine Enclosure
Group 1921 - Grille and Grille Housing
Group 1927 - Fenders

SECTION 20 - SAFETY, CONVENIENCE AND MISCELLANEOUS

Group 2004 - Horn and Warning Devices

SECTION 21 - MAIN HYDRAULIC SYSTEM

Group 2160 - Hydraulic System

SECTION 31 - LOADER

Group 3102 - Buckets
Group 3115 - Controls Linkage
Group 3140 - Frames
Group 3160 - Hydraulic System

SECTION 33 - BACKHOE

Group 3302 - Buckets, Teeth, Shanks, and Sidecutters
Group 3315 - Controls Linkage
Group 3340 - Frames
Group 3360 - Hydraulic System

SECTION 90 - SYSTEM TESTING

Group 9005 - General Information
Group 9010 - Engine
Group 9015 - Electrical System
Group 9020 - Power Train
Group 9025 - Hydraulic System

SECTION 99 - SPECIAL TOOLS

INDEX

<https://www.ebooklibonline.com>

Hello dear friend!

Thank you very much for reading.

Enter the link into your browser.

The full manual is available for immediate download.

<https://www.ebooklibonline.com>

INTRODUCTION

This manual is part of a total service support program.

FOS Manuals—reference

Technical Manuals—machine service

Component Manuals—component service

Fundamentals of Service (FOS) Manuals cover basic theory of operation, fundamentals of troubleshooting, general maintenance, and basic types of failures and their causes. FOS Manuals are for training new personnel and for reference by experienced technicians.

Technical Manuals are concise service guides for specific machines. Technical manuals are on-the-job guides containing only the vital information needed by an experienced service technician.

Component Technical Manuals are concise service guides for specific components. Component technical manuals are written as stand alone manuals covering multiple machine applications.

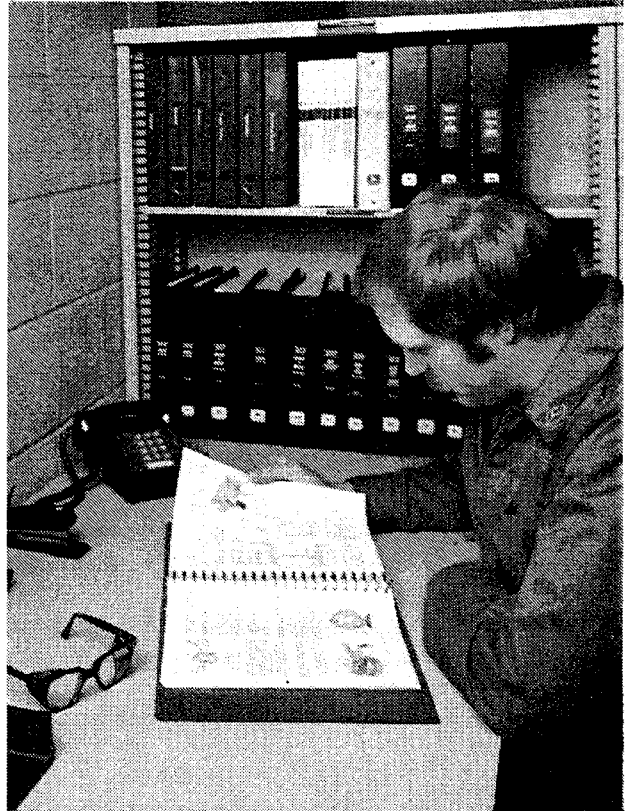

AB6;RW5559 053;INTRO2 030785

FEATURES OF THIS TECHNICAL MANUAL

John Deere ILLUSTRATION format emphasizing illustrations and concise instructions in easy-to-use modules.

Emphasis on diagnosis, analysis, and testing so you can understand the problem and correct it.

Diagnostic information presented with the most logical and easiest to isolate problems first to help you identify the majority of routine failures quickly.

Step-by-step instructions for teardown and assembly.

Summary listing at the beginning of each group of all applicable specifications, wear tolerances, torque values, essential tools, and materials needed to do the job.

An emphasis throughout on safety—so you do the job right without getting hurt.

This technical manual was planned and written for you—an experienced service technician. Keep it in a permanent binder in the shop where it is handy. Refer to it when you need to know correct service procedures or specifications.

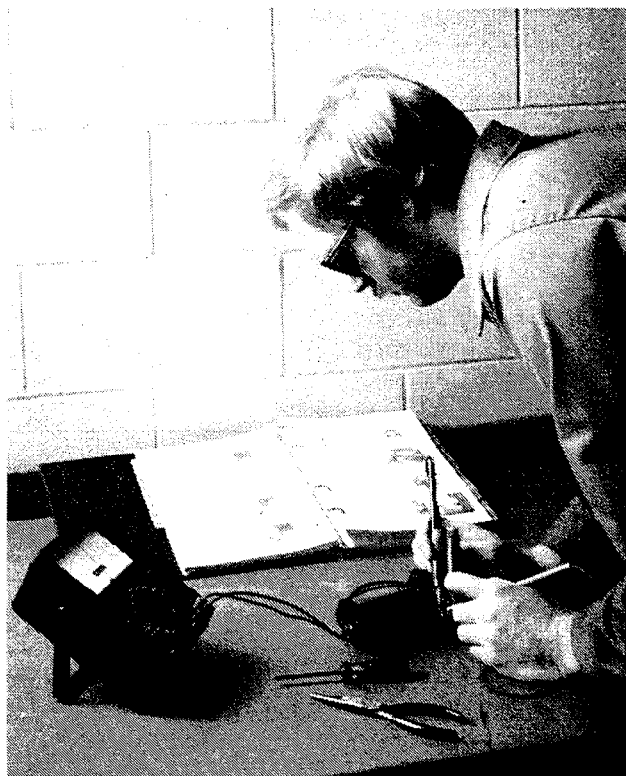

AB6;RW5560 053;INTRO3 071085

SAFETY AND YOU

This is the safety-alert symbol. When you see this symbol on the machine or in this manual, be alert to the potential for personal injury .



AB6;T81389 053;TMSAFE 071085

PREVENT BATTERY EXPLOSIONS

Battery gas can explode. Keep sparks and flames away from batteries. Use a flashlight to check battery electrolyte level.

Never check battery charge by placing a metal object across the posts. Use a voltmeter or hydrometer.

Always remove grounded (-) battery clamp first and replace it last.



AB6;TS181 053;EXPLO 180485

HANDLE FUEL SAFELY—AVOID FIRES

Handle fuel with care: it is highly flammable. Do not refuel the machine while smoking or when near open flame or sparks.

Always stop engine before refueling machine. Fill fuel tank outdoors.

Prevent fires by keeping machine clean of accumulated trash, grease, and debris. Always clean up spilled fuel.

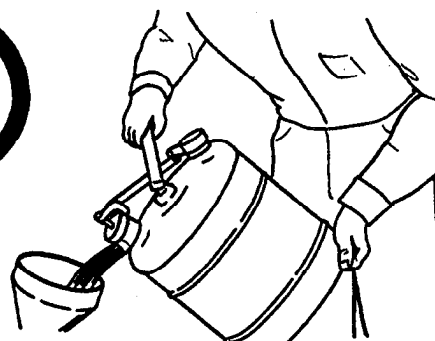

AB6;TS185 053;FIRE1 240785

PREPARE FOR EMERGENCIES

Be prepared if a fire starts.

Keep a first aid kit and fire extinguishers handy.

Keep emergency numbers for doctors, ambulance service, hospital, and fire department near your telephone.



AB6;TS186 053;FIRE2 080785

HANDLE STARTING FLUID SAFELY

Starting fluid is highly flammable.

Keep all sparks and flame away when using it. To prevent accidental discharge when storing the pressurized can, keep the cap on the container, and store in a cool, protected location.

Do not incinerate or puncture a starting fluid container.



AB6;T6089A U 053;FIRE3 080785

UNDERSTAND CORRECT MACHINE OPERATION AND SERVICE

Only qualified people should operate and service the machine.

Learn the location and purpose of all controls, instruments, indicators, and labels.

Be sure you understand a service procedure before you work on the machine.

Unauthorized modifications to the machine may impair the function and/or safety and affect machine life.

If it is necessary to make checks with the engine running, ALWAYS USE TWO PEOPLE — with the operator at the controls, able to see the person doing the checking.

Be sure transmission shift lever is in neutral. Apply and lock park brake.

KEEP HANDS AWAY FROM MOVING PARTS.



8NA;T6073AO T82;BHSA C 030485

WEAR PROTECTIVE CLOTHING

Wear fairly tight clothing . . . and safety equipment.

44A;T85056 T82;EXSA B 060684

PROTECT AGAINST NOISE

Prolonged exposure to loud noise can cause impairment or loss of hearing.

Wear a suitable hearing protective device such as earmuffs (A) or earplugs (B) to protect against objectionable uncomfortable loud noises.

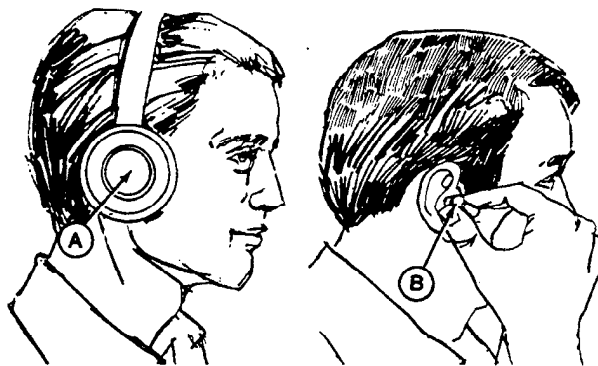

AB6;X7662 053;NOISE 150584

AVOID HIGH-PRESSURE FLUIDS

Escaping fluid under pressure can penetrate the skin causing serious injury. Relieve pressure before disconnecting hydraulic or other lines. Tighten all connections before applying pressure. Keep hands and body away from pinholes and nozzles which eject fluids under high pressure. Use a piece of cardboard or paper to search for leaks.

If ANY fluid is injected into the skin, it must be surgically removed within a few hours by a doctor familiar with this type injury or gangrene may result.

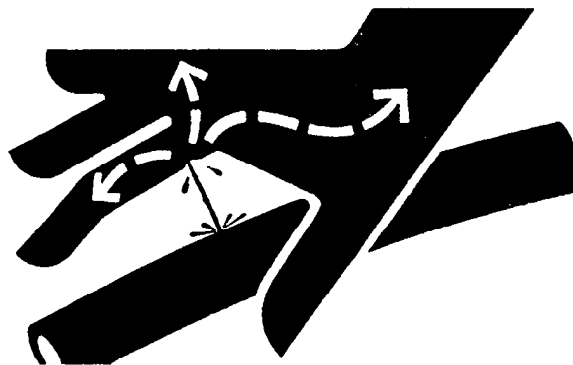

AB6;X9811 053;FLUID 100584

PREVENT MACHINE RUNAWAY

Avoid possible injury or death from machinery runaway.

Do not start engine by shorting across starter terminals. Machine will start in gear if normal circuitry is by passed.

NEVER start engine while standing on ground. Start engine only from operator's seat, with transmission in neutral or park.

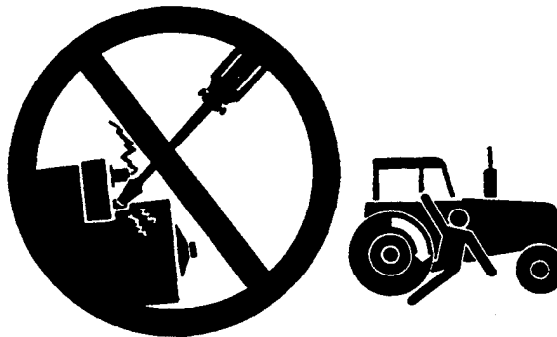

AB6;TS177 053;BYPAS1 210585

INSPECT MACHINE

Inspect your machine carefully each day before you start it.
(See Pre-Start Inspection chapter.)

Use handholds and steps when you get on and off the machine. DO NOT use the steering wheel as a handrail.



018;T5813AN T82;FLSA P 010485

USE SEAT BELT PROPERLY

Use a seat belt when you operate with a roll-over protective structure (ROPS) to minimize chance of injury from an accident such as an overturn.

Do not use a seat belt if operating without a ROPS.

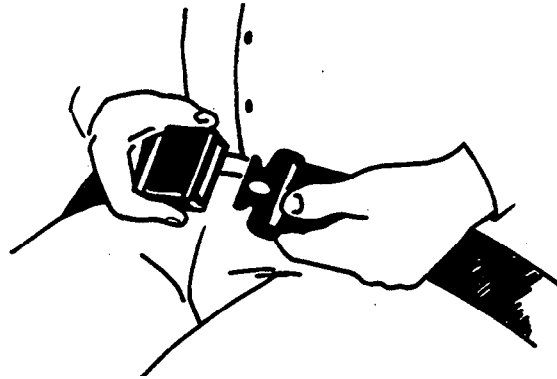

AB6;TS175 053;ROPS1 261184

KEEP RIDERS OFF MACHINE

Only allow the operator on the machine. Keep riders off.

Riders on machine are subject to injury such as being struck by foreign objects and being thrown off of the machine. Riders also obstruct the operator's view resulting in the machine being operated in an unsafe manner.



AB6;TS173 053;RIDER 261184

PROTECT AGAINST FLYING DEBRIS

When you drive connecting pins in or out, guard against injury from flying pieces of metal or debris; wear goggles or safety glasses.

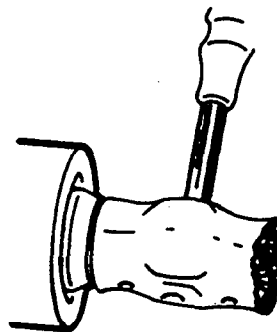

8NA;T6073AP T82;BHS A R 070585 JW

SUPPORT RAISED EQUIPMENT

Put a support (A) under all raised equipment.

Do not work under a raised bucket. Lower the bucket to ground or onto blocks.

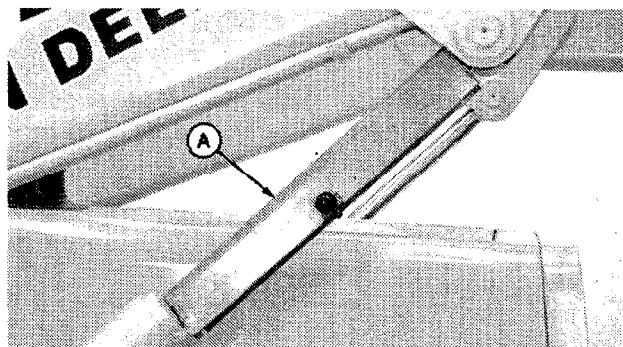

8NA;T86911 T82;BHS A S 250882

TEST COOLANT HEATER IN LIQUID ONLY

Do not plug coolant heater into electrical power unless heating element is immersed in coolant. Sheath could burst and result in personal injury.

Use a heavy-duty grounded cord to connect coolant heater to electrical power.

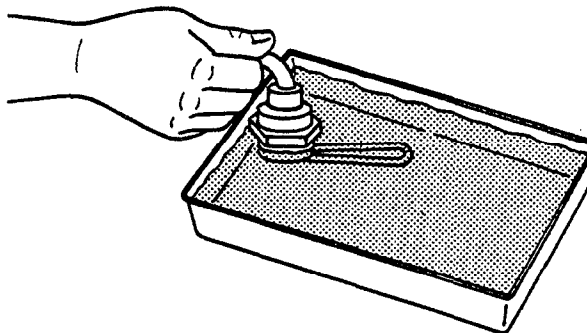

AB6;TS174 053;HEAT 110584

KEEP ROPS INSTALLED PROPERLY

Make certain all parts are reinstalled correctly if the roll-over protective structure (ROPS) is loosened or removed for any reason. Tighten mounting bolts to proper torque.

The protection offered by ROPS will be impaired if ROPS is subjected to structural damage, is involved in an overturn incident, or is in any way altered. A damaged ROPS should be replaced, not reused.

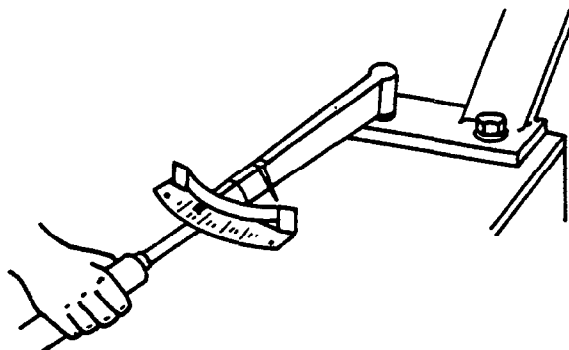

AB6;TS176 053;ROPS3 261184

SERVICE TIRES SAFELY

Failure to follow proper procedures when mounting a tire on a wheel or rim can produce an explosion which may result in serious injury or death. Do not attempt to mount a tire unless you have the proper equipment and experience to perform the job. Have it done by your John Deere dealer or a qualified repair service.

Detailed tire mounting instructions, including necessary safety precautions, are contained in John Deere Fundamentals of Service (FOS) Manual 55. Tires and Tracks, available through your John Deere dealer. Such information is also available from the Rubber Manufacturers Association and from tire manufacturers.

A—Use a Safety Cage if Available
B—Do Not Stand Over Tire—Use a
Clip-on Chuck and Extension Hose

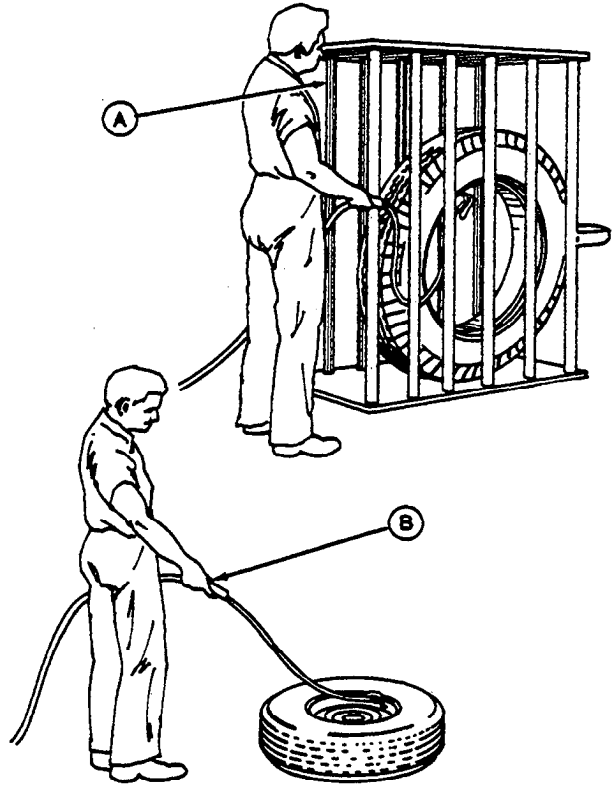

AB6;TS0123 053;TIRE2 110584

USE A SAFETY CHAIN

A safety chain will help control drawn equipment (B) should it accidentally separate from the drawbar (A) while transporting. Using the appropriate adapter parts, attach the chain to the tractor drawbar support or other specified anchor location. Provide only enough slack in the chain to permit turning. See your John Deere dealer for a chain with a strength rating equal to or greater than the gross weight of the towed machine.

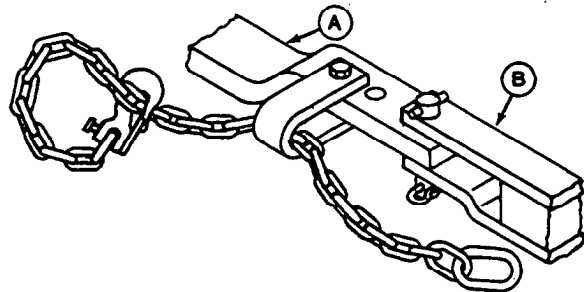

AB6;TS163 053;CHAIN 310884

CLEAN MACHINE REGULARLY

Remove any grease, oil or debris build-up to avoid possible injury or machine damage.

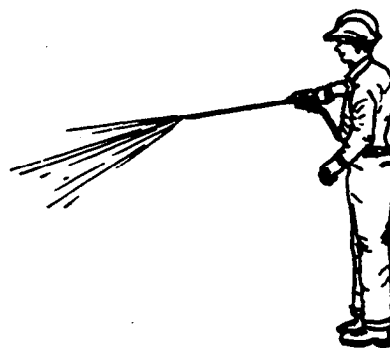

002;T5813AM T82;BHSA BM 170485

PREPARE MACHINE FOR REPAIR

Before you leave the operator's station:

1. Park the machine on a level surface.
2. Lower all equipment to ground.
3. Move speed control lever to slow idle position.
4. Move park brake lever (D) up to engage park brake.
5. Move gear shift lever (A) to neutral "N".
6. Move direction selector lever (B) to neutral.
7. Turn lever (C) to lock direction selector lever in neutral.
8. Turn key switch off.
9. Release hydraulic pressure by moving hydraulic control levers until no hydraulic function moves.
10. Remove all keys from switches and locks.
11. Disconnect negative (—) ground strap.

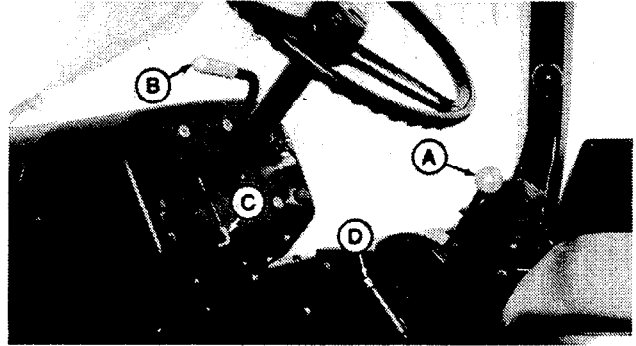

8NA;T88922 T82;BHSA BZ 210585

SERVICE TIRES SAFELY

Failure to follow proper procedures when mounting a tire on a wheel or rim can produce an explosion which may result in serious injury or death. Do not attempt to mount a tire unless you have the proper equipment and experience to perform the job. Have it done by your John Deere dealer or a qualified repair service.

Detailed tire mounting instructions, including necessary safety precautions are contained in John Deere Fundamentals of Service (FOS) Manual 55, Tires and Tracks, available through your John Deere dealer. Such information is also available from the Rubber Manufacturers Association and from tire manufacturers.

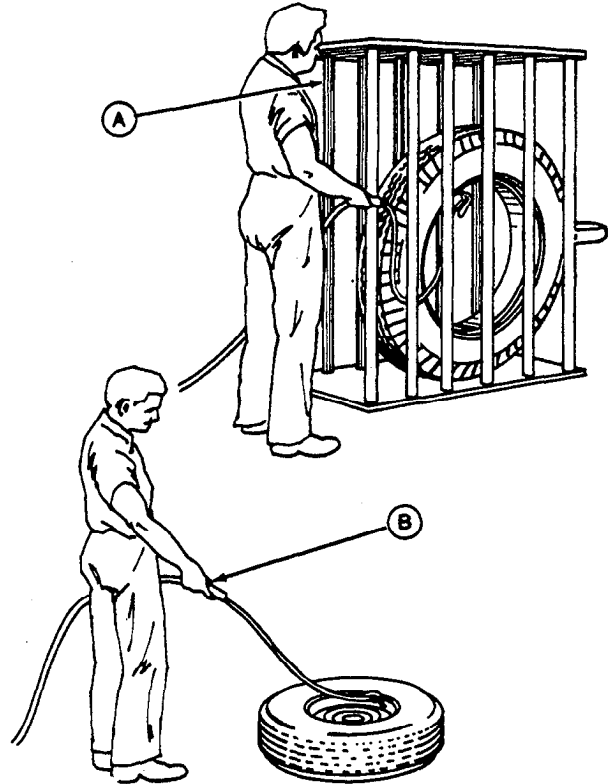

- A—Use a Safety Cage if available.
B—DO NOT Stand Over Tire. Use a Clip-On Chuck and Extension Hose.

63A;TS0123 T82;TL5A M 191282

PREPARE MACHINE FOR REPAIR

1. Lower all equipment to the ground.
2. Put transmission in PARK or engage parking brake.
3. Stop the engine.
4. Operate all hydraulic control levers to release hydraulic pressure in the system.
5. Disconnect negative (-) battery cable.



63A;T88895 T82;BHSA AG 270483

Group II SPECIFICATIONS

(Specifications and design subject of change without notice. Wherever applicable, specifications are in accordance with ICED and SAE Standards. Except where otherwise noted, these specifications are based on a standard machine with 21L-24, 16PR, R4 rear tires; 14.5/75-16.1, 12PR, F3 front tires with 75 percent CaCl₂ fill; 1.5-cu.-yd. (1.15 m³) loader bucket; 24-in. (610 mm) backhoe bucket; ROPS/FOPS; full fuel tank and 175-lb. (79 kg) operator).

Power

| | | |
|----------------------|----------------|----------------|
| (@ 2200 engine rpm): | SAE | DIN |
| Gross | 105 hp (78 kW) | |
| Net | 100 hp (75 kW) | 101 hp (74 kW) |

Net engine flywheel power is for an engine equipped with fan, air cleaner, water pump, lubricating oil pump, fuel pump, alternator, and muffler. Gross engine power is without fan. Flywheel power ratings are under SAE standard conditions of 500-ft. (150 m) altitude and 85°F (29.5°C) temperature and DIN 70 020 standard conditions of 760 mm Hg barometer (sea level) and 20°C temperature.

Engine: John Deere 6-cylinder turbocharged diesel, valve in head 4-stroke cycle

| | |
|---|--|
| Bore and stroke | 4.02 x 4.33 in. (102 x 110 mm) |
| Displacement | 329 cu. in. (5.392 L) |
| Compression ratio | 16.2 to 1 |
| Maximum torque @ 1300 rpm | 290 lb-ft (393 N-m) |
| NACC or AMA (U.S. Tax) horsepower | 38.8 |
| Main bearings | 7 |
| Lubrication | Pressure system w/full-flow filter and cooler |
| Cooling | Pressurized w/thermostat and fixed bypass |
| Fan | Suction |
| Air cleaner | Dry |
| Electrical system | 12-volt |
| Alternator | 51 amps w/cab, 35 amps regular |

Transmission:

Full power shift, 8 speeds forward, 4 reverse. Modulated, full power shift between forward and reverse in first thru fourth speeds. Direction selector lever left of steering wheel. Single speed-change lever in right console.

| Travel Speeds: | Forward | | Reverse | |
|----------------|---------|------|---------|------|
| | mph | km/h | mph | km/h |
| Gear 1 | 1.8 | 2.9 | 2.2 | 3.5 |
| 2 | 2.6 | 4.2 | 3.2 | 5.1 |
| 3 | 4.0 | 6.4 | 4.9 | 7.9 |
| 4 | 5.2 | 8.4 | 6.4 | 10.3 |
| 5 | 6.8 | 11.0 | | |
| 6 | 8.8 | 14.2 | | |
| 7 | 11.5 | 18.5 | | |
| 8 | 19.5 | 31.4 | | |

Final Drives Planetary, inboard

Brakes Hydraulic, power actuated, fully enclosed wet disk. Foot-operated individually or simultaneously, self-equalizing.

Steering: Hydrostatic power

| | |
|---|------------------------|
| Turning radius (brake applied) | 14 ft. 2 in. (4.32 m) |
| Clearance circle | 37 ft. 4 in. (11.40 m) |
| Steering wheel turns, left to right | 3.0 |
| right to left | 3.8 |

Hydraulic System: Closed center (variable flow, constant pressure)

| | |
|------------------------------------|--|
| Pressure | 2500 psi (17 238 kPa) |
| Pump | 16 radial pistons, variable flow |
| Flow @ 2200 psi (15 170 kPa) | 53 gpm (3.34 L/s) |
| Filter, return oil | 10 micron steel enclosed, replaceable paper element |
| Screen, pressure oil | 50/in. (20/cm) mesh |

Hydraulic Cylinders:

| | Bore | Stroke | Rod |
|--|---------------------|-----------------------|---------------------|
| Loader boom (2) | 3.75 in. (95 mm) | 33.0 in. (840 mm) | 2.0 in. (51 mm) |
| Loader bucket (1) | 4/5 in. (114 mm) | 26.5 in. (673 mm) | 2.0 in. (51 mm) |
| Backhoe boom (1) | 6.0 in. (152 mm) | 44.4 in. (1128 mm) | 2.75 in. (70 mm) |
| Backhoe crowd (1) | 5.5 in. (140 mm) | 35.4 in. (900 mm) | 2.75 in. (70 mm) |
| Backhoe bucket (1) | 4.0 in. (102 mm) | 37.5 in. (953 mm) | 2.5 in. (64 mm) |
| Backhoe swing (2) | 4.5 in. (114 mm) | 9.9 in. (251 mm) | 2.25 in. (57 mm) |
| Backhoe extendible dipper (1) | 3.0 in. (76 mm) | 60 in. (1525 mm) | 1.5 in. (38 mm) |
| Backhoe stabilizers (2) | 4.5 in. (114 mm) | 21.5 in. (546 mm) | 2.5 in. (64 mm) |
| Steering (1) regular axle | 2.75 in. (70 mm) | 9.0 in. (229 mm) | 1.25 in. (32 mm) |

Tires:

| | |
|-------------|--|
| Front | (Use with MFWD) 14 x 17.5 10 PR (with calcium chloride) (DO NOT use with MFWD) 14.5/75-16.1 10 PR F3 |
| Rear | (DO NOT use with MFWD) 20.5 x 25 12 PR L2 or L3 (Use with MFWD) 21 x 24 16 PR R4 |

Wheel Treads:

| | |
|-------------|------------------|
| Front | 72 in. (1830 mm) |
| Rear | 68 in. (1730 mm) |

Wheelbase 94 in. (2400 mm)

Axle Ratings: (SAE J43)

| | |
|-------------|----------------------|
| Front | 12,500 lb. (5670 kg) |
| Rear | 19,400 lb. (8800 kg) |

T82;BHSP A 040485

Specifications

OPERATING INFORMATION

BACKHOE:

| | |
|--|-----------------------------------|
| Operator control | Two levers |
| Digging depth (ICED): | |
| Maximum | 17 ft. 11 in. (5.46 m) |
| 2-ft. (610 mm) flat bottom | 17 ft. 10 in. (5.45 m) |
| 8-ft. (2440 mm) flat bottom | 17 ft. 0 in. (5.20 m) |
| Swing arc | 180 deg. |
| Lifting capacity: | |
| Boom lifting, dipper extended | 2800 lb. (1270 kg) |
| Dipper lifting, boom @ 65° | 6000 lb. (2720 kg) |
| Digging force: | |
| Bucket cylinder in power-dig position | 13,500 lb. (60 kN) |
| Crowd cylinder | 9600 lb. (42.7 kN) |
| Reach: | |
| From center of swing mast | 22 ft. 8 in. (6.90 m) |
| From center of rear axle | 26 ft. 9 in. (8.15 m) |
| Loading height, truck loading position | 13 ft. 2 in. (4.01 m) |
| Transport height | 13 ft. 9 in. (4.20 m) |
| Bucket rotation | Adjustable for 149 or 159 degrees |
| Bucket positions | 0 to 13 degrees rollback |

EXTENDIBLE DIPPER

| | |
|---|------------------------|
| Operator control | Right foot treadle |
| Digging depth, 2-ft. (610 mm) flat bottom | |
| Extended | 22 ft. 8 in. (6.90 m) |
| Retracted | 17 ft. 9 in. (5.40 m) |
| Reach from center of swing mast | |
| Extended | 27 ft. 1 in. (8.25 m) |
| Retracted | 22 ft. 4 in. (6.80 m) |
| Loading height, truck loading position | |
| Extended | 15 ft. (4.60 m) |
| Retracted | 12 ft. 11 in. (3.95 m) |
| Digging force, crowd cylinder | |
| Extended | 6700 lb. (29.8 kN) |
| Retracted | 9600 lb. (42.7 kN) |

STABILIZERS:

| | |
|------------------------------------|-----------------------|
| Operator control | Two levers |
| Transport width | 8 ft. (2.44 m) |
| Spread in operating position | 11 ft. 5 in. (3.48 m) |
| Angle rearward | 13 degrees |

LOADER:

| | |
|---|-----------------------|
| Operator control | Single lever |
| Rollback @ ground level | 40 deg. |
| Breakout force | 10,600 lb. (47.1 kN) |
| Digging depth below ground, bucket level | 4 in. (100 mm) |
| Lifting capacity, full height | 6900 lb. (3130 kg) |
| Height to bucket hinge pin, max. | 11 ft. 3 in. (3.45 m) |
| Bucket dump angle, max. | 47 degrees |
| Dump clearance, bucket @ 45 degrees | 8 ft. 11 in. (2.72 m) |
| Reach at full height, bucket @ 45 degrees | 36 in. (915 mm) |

BUCKETS

| Loader: | Width | | Struck Capacity | | Heaped Capacity | |
|-----------------|--------|------|-----------------|-------------------|-----------------|------------------------|
| | In. | (mm) | Cu. Ft. | (m ³) | Cu. Yd. | (m ³) |
| 92 | (2340) | | | | 1.5 | (1.15) |
| Backhoe: | | | | | Cu. Ft. | (m³) |
| 18 | (457) | 6.7 | (0.19) | 7.7 | (0.22) | |
| 24 | (610) | 9.4 | (0.27) | 11.1 | (0.31) | |
| 30 | (762) | 12.2 | (0.35) | 15.0 | (0.42) | |
| 36 | (914) | 15.0 | (0.42) | 18.8 | (0.53) | |

CAPACITIES:

| | U.S. | Metric |
|---|-----------|--------|
| Engine coolant | 28 qt. | 26L |
| Engine oil including filter | 20 qt. | 19L |
| Transmission and hydraulic system | 20 gal. | 76L |
| Rear axle | 18 qt. | 17L |
| Fuel tank | 33 gal. | 125L |
| Transfer case (MFWD) | 11.25 gal | 42.6L |
| Front axle housing (MFWD) | 11 qt | 10.4L |
| Front wheel planetary (MFWD) | 1 qt | 1L |

TRANSPORTING:

| | |
|--------------------------------------|---------------------------|
| SAE operating weight with ROPS | 9890 kg. (21800 lb.) |
| Minimum ground clearance | 354 mm (14.0 in.) |
| Overall length | 8.13 m (26 ft. 8 in.) |
| Overall width | 2.33 m (7 ft. 7.7 in.) |

T82;BHSP B 040485

Specifications

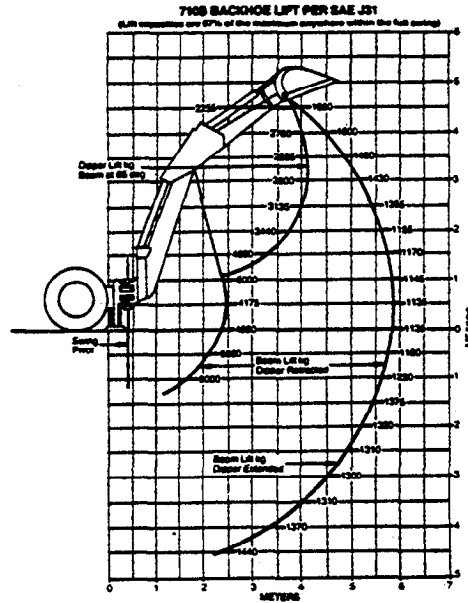
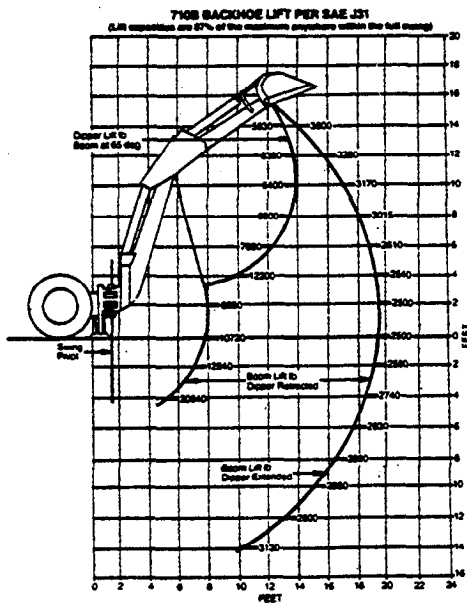
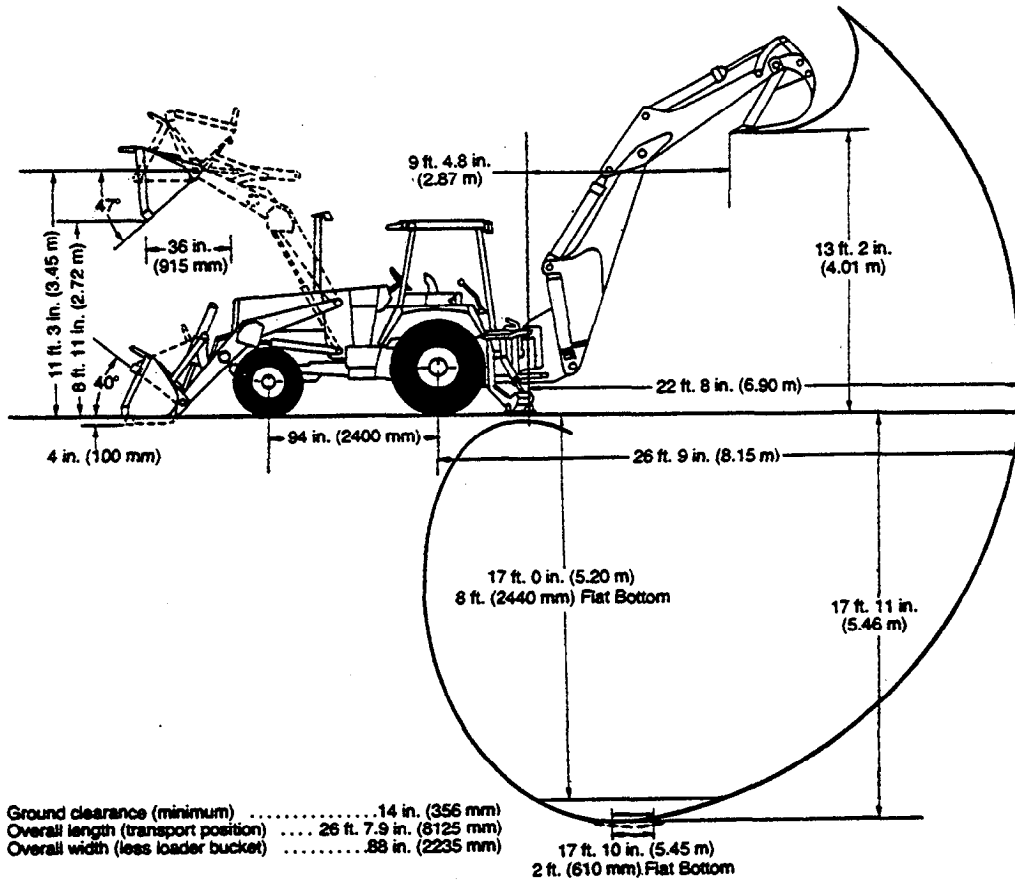

63A;T90622 T82;BHSP H 080383



HARDWARE TORQUE SPECIFICATIONS

Check cap screws and nuts to be sure they are tight. If hardware is loose, tighten it to torque shown on the following charts unless a special torque is specified.

T82;CRMA EC 260785

NOTE: Torques shown are for dry (no lubrication on threads) hardware.

NOTE: Torque wrench tolerance is ± 10 per cent of specified torque.

| Customary Hardware | | | | | | |
|--------------------------|--|-------|--|--------|--|--------|
| Cap Screw Size-Inches |  Grade B | |  Grade D | |  Grade F | |
| | lb-ft. | (N-m) | lb-ft. | (N-m) | lb-ft. | (N-m) |
| 1/4 | ---- | ---- | 10 | (14) | 14 | (19) |
| 5/16 | ---- | ---- | 20 | (27) | 30 | (41) |
| 3/8 | ---- | ---- | 35 | (47) | 50 | (68) |
| 7/16 | 35 | (47) | 55 | (75) | 80 | (108) |
| 1/2 | 55 | (75) | 85 | (115) | 120 | (163) |
| 9/16 | 75 | (102) | 130 | (176) | 175 | (237) |
| 5/8 | 105 | (142) | 170 | (230) | 240 | (325) |
| 3/4 | 185 | (251) | 300 | (407) | 425 | (576) |
| 7/8 | 160 | (217) | 445 | (603) | 685 | (929) |
| 1 | 250 | (339) | 670 | (908) | 1030 | (1396) |
| 1-1/8 | 330 | (447) | 910 | (1234) | 1460 | (1979) |
| 1-1/4 | 480 | (651) | 1250 | (1695) | 2060 | (2793) |

002;T88884 T82;BHMA CQ 060185

Torque Values

METRIC HARDWARE TORQUE CHART

NOTE: Torques shown are for hardware with SAE30W oil on threads.

NOTE: Torque wrench tolerance is ± 10 percent of specified torque.

Metric Standard Thread

| Thread | 8.8 | | 10.9 | | 12.9 | |
|--------|-------|---------|-------|---------|--------|---------|
| | N-m | lb-ft | N-m | (lb-ft) | N-m | (lb-ft) |
| M5 | 5.9 | (4.4) | 7.9 | (5.8) | 9.8 | (7.2) |
| M6 | 9.8 | (7.2) | 13.8 | (10.2) | 16.7 | (12.3) |
| M8 | 24.6 | (18.1) | 34.4 | (25.4) | 40.2 | (29.6) |
| M10 | 48.1 | (35.5) | 67.8 | (50.0) | 81.5 | (60.1) |
| M12 | 84.4 | (62.2) | 118.0 | (87.0) | 142.0 | (105.0) |
| M14 | 133.0 | (98.0) | 187.0 | (138.0) | 226.0 | (167.0) |
| M16 | 206.0 | (152.0) | 290.0 | (214.0) | 348.0 | (257.0) |
| M18 | 285.0 | (210.0) | 398.0 | (294.0) | 476.0 | (351.0) |
| M20 | 402.0 | (296.0) | 570.0 | (420.0) | 677.0 | (499.0) |
| M22 | 540.0 | (398.0) | 765.0 | (564.0) | 914.0 | (674.0) |
| M24 | 697.0 | (514.0) | 980.0 | (723.0) | 1180.0 | (870.0) |

Metric Fine Thread

| Thread | 8.8 | | 10.9 | | 12.9 | |
|-----------|--------|---------|--------|----------|--------|----------|
| | N-m | (lb-ft) | N-m | (lb-ft) | (N-m) | lb-ft) |
| M8 x 1 | 26.5 | (19.5) | 37.3 | (27.5) | 44.2 | (32.6) |
| M10 x 1 | 47.1 | (34.7) | 68.8 | (50.7) | 81.5 | (60.1) |
| M12 x 1.5 | 88.4 | (65.2) | 123.0 | (91.0) | 147.0 | (108.0) |
| M14 x 1.5 | 147.0 | (108.0) | 206.0 | (152.0) | 246.0 | (181.0) |
| M16 x 1.5 | 221.0 | (163.0) | 309.0 | (228.0) | 373.0 | (275.0) |
| M18 x 1.5 | 319.0 | (235.0) | 451.0 | (333.0) | 540.0 | (398.0) |
| M20 x 1.5 | 451.0 | (333.0) | 628.0 | (463.0) | 755.0 | (557.0) |
| M22 x 1.5 | 599.0 | (442.0) | 845.0 | (623.0) | 1030.0 | (760.0) |
| M24 x 2 | 765.0 | (564.0) | 1080.0 | (796.0) | 1275.0 | (940.0) |
| M26 x 2 | 1130.0 | (833.0) | 1570.0 | (1158.0) | 1915.0 | (1412.0) |

T82;EXMA T 290384

O-RING BOSS FITTING SERVICE RECOMMENDATIONS

1. Inspect boss O-ring seat. It must be free of dirt and defects. If repeated leaks occur, inspect for defects with a magnifying glass. Some raised defects can be removed with a slip stone.

Occasionally a lower durometer O-ring will seal against a rough seat. If neither of these solutions work, the component must be replaced.

2. Lubricate O-ring using petroleum jelly. Put a thimble over the threads to protect O-ring from nicks. Slide O-ring over the thimble and into the turned down section of fitting.

For angle fittings, loosen special nut and push special washer against threads so O-ring can be installed into the turned down section of fitting.

3. Turn fitting into the boss by hand until special washer or washer face (straight fitting) contacts boss face and O-ring is squeezed into its seat.

4. To position angle fittings, turn the fitting counterclockwise a maximum of one turn.

5. Tighten straight fittings to the torque value shown in chart. For angle fittings, tighten the special nut to valve shown in the chart while holding body of fitting with a wrench.

STRAIGHT FITTING OR SPECIAL NUT TORQUE (1)

| Thread Size | Torque ¹ | | Number Of Flats ² |
|--------------|---------------------|---------|------------------------------|
| | N·m | (lb-ft) | |
| 3/8-24 UNF | 8 | (6) | 2 |
| 7/16-20 UNF | 12 | (9) | 2 |
| 1/2-20 UNF | 16 | (12) | 2 |
| 9/16-18 UNF | 24 | (18) | 2 |
| 3/4-16 UNF | 46 | (34) | 2 |
| 7/8-14 UNF | 62 | (46) | 1-1/2 |
| 1-1/16-12 UN | 102 | (75) | 1 |
| 1-3/16-12 UN | 122 | (90) | 1 |
| 1-5/16-12 UN | 142 | (105) | 3/4 |
| 1-5/8-12 UN | 190 | (140) | 3/4 |
| 1-7/8-12 UN | 217 | (160) | 1/2 |

1. Tolerance $\pm 10\%$.

2. To be used if a torque wrench cannot be used. After tightening fitting by hand, put a mark on nut and boss; then tighten special nut or straight fitting the number of flats shown.

TUBE AND HOSE FITTING, 37° FLARE AND 30° CONE SEAT CONNECTOR SERVICE RECOMMENDATIONS

1. Inspect the flare and the flare seat. They must be free of dirt and defects. If repeated leaks occur, inspect for defects with a magnifying glass. If burrs and raised nicks on the connector body cannot be removed with a slip stone, replace the connector.
2. Defects in the tube flare cannot be repaired. Replace the tube. Overtightening a defective flared fitting will not stop leaks.
3. As a field repair, a ductile truncated cone shaped washer can be used between the tube flare and connector body. These washers are soft enough to fill defects in the seat and flare. They will also seal the connection. Ductile washers are available from industrial supply houses.
4. Align the tube with the fitting before attempting to start the nut. Failure to do so can cause a deformed flare and subsequent leaks. Install hoses without twists. A twisted hose attempts to straighten out when pressure is applied. This exerts a torque on the connection, eventually causing failure.
5. Lubricate the connection with hydraulic fluid, petroleum jelly or soap. Tighten the swivel nut by hand until it is snug.
6. Mark a line across the nut and connector body. This line will serve as a visual indicator as to whether the nut has been tightened and by how much.
7. Using two wrenches, one on the connector body and a torque wrench on the nut, tighten the nut to the torque value as shown in the chart. In the case of a hose, it may be necessary to use three wrenches to prevent twisting.

TUBE AND HOSE FITTING, 37° FLARE AND 30° CONE SEAT CONNECTOR TORQUE

| Thread Size | Torque ¹ | | New ² Number of Flats | Used ³ Number of Flats |
|----------------|---------------------|---------|-------------------------------------|--------------------------------------|
| | N·m | (lb-ft) | | |
| 3/8-24 UNF | 8 | (6) | 2-1/2 | 1 |
| 7/16-20 UNF | 12 | (9) | 2-1/2 | 1 |
| 1/2-20 UNF | 16 | (12) | 2-1/2 | 1 |
| 9/16-18 UNF | 24 | (18) | 2 | 1 |
| 3/4-16 UNF | 46 | (34) | 2 | 1 |
| 7/8-14 UNF | 62 | (46) | 1-1/2 | 1 |
| 1-1/16-12 UN | 102 | (75) | 1 | 3/4 |
| 1-3/16-12 UN | 122 | (90) | 1 | 3/4 |
| 1-5/16-12 UN | 142 | (105) | 3/4 | 3/4 |
| 1-5/8-12 UN | 190 | (140) | 3/4 | 3/4 |
| 1-7/8-12 UN | 217 | (160) | 1/2 | 1/2 |

1. Tolerance of $\pm 10\%$.

2. To be used if a torque wrench cannot be used. After tightening fitting by hand, put a mark across the fittings, then tighten fitting the number of flats shown.

3. Flare connection seal by deforming or squeezing the tube between the nut and the connector. More deformation is possible with new parts than with old. Therefore, if a torque wrench is not used for re-assembly, the values in this column must be used to prevent damage.

T82,7,PD AB 150363

**SERVICE RECOMMENDATIONS FOR
FLAT FACE O-RING SEAL FITTINGS**

1. Inspect the fitting sealing surfaces. They must be free of dirt or defects.
2. Inspect the O-ring. It must be free of damage or defects.
3. Lubricate O-rings and male threads with petroleum jelly.
4. Push O-ring into the groove.
5. Index angle fittings and tighten by hand.
6. Tighten fitting or nut to torque value shown on the chart per dash size shown on the chart per dash size stamped on the fitting. Do not allow hoses to twist while tightening fittings.

FLAT FACE O-RING SEAL FITTING TORQUE (1)

| Nominal | | Dash Size | Thread Size in. | O-Ring Face Seal End | | O-Ring Boss End | |
|------------|-------------|--------------|-----------------------|----------------------------|-------------------------------|------------------------------|---------------------------------|
| Tube mm | O.D. in. | | | Swivel Nut Torque Nm | Swivel Nut Torque lb-ft | Bulkhead Nut Torque Nm | Bulkhead Nut Torque lb-ft |
| 4.76 | 0.188 | -3 | ----- | ---- | ---- | ---- | ---- |
| 6.35 | 0.250 | -4 | 9/16-18 | 16 | 12 | 5.0 | 3.5 |
| 7.94 | 0.312 | -5 | ----- | ---- | ---- | ---- | ---- |
| 9.52 | 0.375 | -6 | 11/16-16 | 24 | 18 | 9.0 | 6.5 |
| 12.70 | 0.500 | -8 | 13/16-16 | 50 | 37 | 17.0 | 12.5 |
| 15.88 | 0.625 | -10 | 1-14 | 69 | 51 | 17.0 | 12.5 |
| 19.05 | 0.750 | -12 | 1 3/16-12 | 102 | 75 | 17.0 | 12.5 |
| 22.22 | 0.875 | -14 | 1 3/16-12 | 102 | 75 | 17.0 | 12.5 |
| 25.40 | 1.000 | -16 | 1 7/16-12 | 142 | 105 | 17.0 | 12.5 |
| 31.75 | 1.250 | -20 | 1 11/16-12 | 190 | 140 | 17.0 | 12.5 |
| 38.10 | 1.500 | -24 | 2-12 | 217 | 160 | 17.0 | 12.5 |

1. Tolerance: +15 -20%

CHECK THE HOUR METER REGULARLY

Check the hour meter (A) to determine when your machine needs periodic maintenance.

Intervals on the periodic maintenance chart are for operating in normal conditions. If you operate your machine in difficult conditions, you should service it at SHORTER INTERVALS.

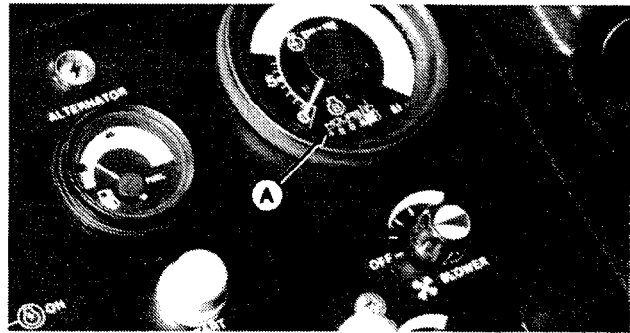

63A;T88888 T82;BHPM B 070284

FUEL SPECIFICATIONS

Use ONLY clean, high-quality fuel.

Use Grade No. 2-D fuel above 4°C (40°F).

Use Grade No. 1-D fuel below 4°C (40°F).

Use Grade No. 1-D fuel for all air temperatures at altitudes above 1 500 m (5000 ft).

IMPORTANT: If fuel sulfur content exceeds 0.5 per cent, the engine oil drain interval must be reduced by 50 per cent (to 125 hours).

Use fuel with less than 1.0 per cent sulfur. If possible, use fuel with less than 0.5 per cent sulfur.

For maximum filter life, sediment and water should not be more than 0.10 per cent.

The cetane number should be 40 minimum. If you operate your machine where air temperatures are normally low or where altitudes are high, you may need fuel with a higher cetane number.

Cloud Point—For cold weather operation, cloud point should be 6°C (10°F) below lowest normal air temperature.

T82;BHFL F 230985 JW

FUEL STORAGE

NOTE: Diesel fuels stored for a long time may form gum and plug filters.

Keep fuel in a clean container in a protected area. Water and sediment must be removed before fuel gets to the engine. Do not use de-icers to remove water from fuel. Do not depend on fuel filters to remove water.

If possible, install a water separator at the storage tank outlet. See your John Deere dealer for this part.

IMPORTANT: Keep all dirt, scale, water or other foreign material out of fuel.

Store fuel drums on their sides with plugs up.

T82:BFHL G 150982

FUEL TANK



CAUTION: Handle fuel carefully. If the engine is hot or running, do not fill the fuel tank. Do not smoke while you fill fuel tank or work on fuel system.

To avoid condensation, fill the fuel tank at the end of each day's operation.

T82:BFHL H 080483

ENGINE OIL

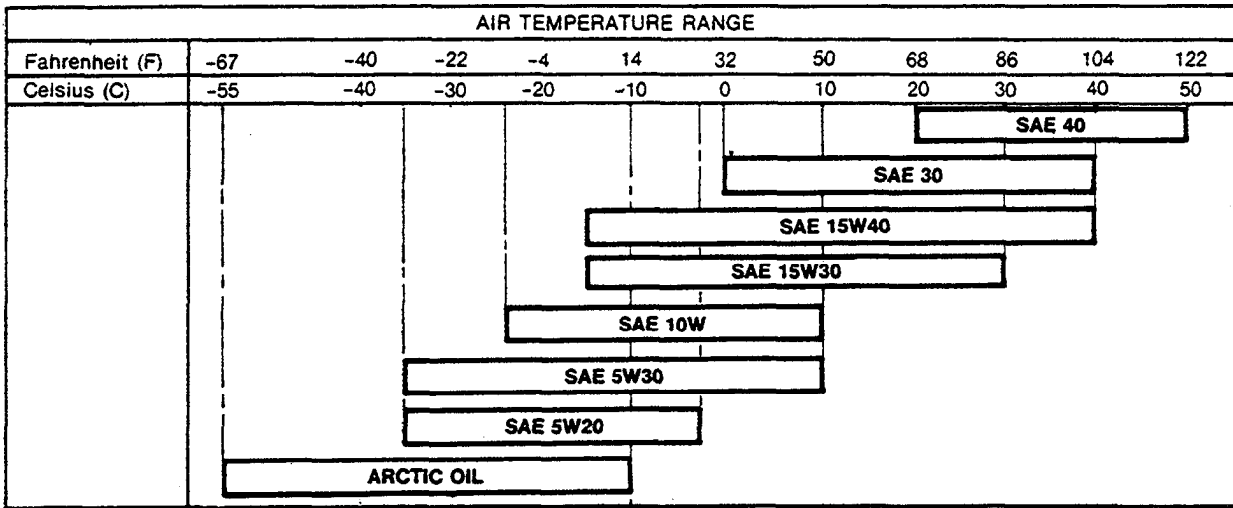

Depending upon the expected air temperature range between oil changes, use oil viscosity shown on the temperature chart above.

Additives are not required nor recommended.

John Deere TORQ-GARD SUPREME® engine oil is recommended. If other oils are used, they must have the following minimum specifications:

| Oil Specification | Use |
|--|---|
| API Service CD/SC (MIL-L-2104C) | Recommended |
| API Service CC/SC* or MIL-L-46152* | For SAE 5W20, SAE 5W30 and arctic oil only, use if recommended oil is not available |
| MIL-L-46167* | For arctic oil only |
| *Change oil at 100 hours, which is half the normal drain interval. | |

BNA:T91372 T82:BHFL A 210284

MECHANICAL FRONT WHEEL DRIVE OIL

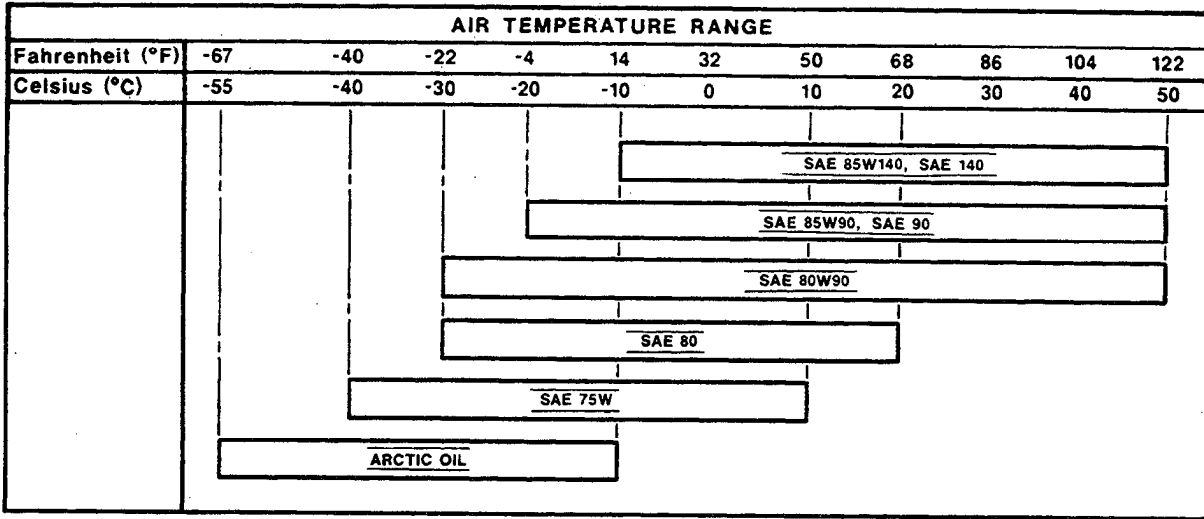

Depending on the expected air temperature range between oil changes, use oil viscosity shown on the chart above.

The following oils are recommended:

- John Deere API GL-5 Gear Oil (SAE 80W90)
- Oils meeting API Service GL-5 (MIL-L-2105B or MIL-2105C) (SAE 80W90)

Oil meeting MIL-L-10324A may be used as arctic oil.

002;T6065AP T82;BHFL W 080485

TRANSMISSION - HYDRAULIC - DIFFERENTIAL OIL

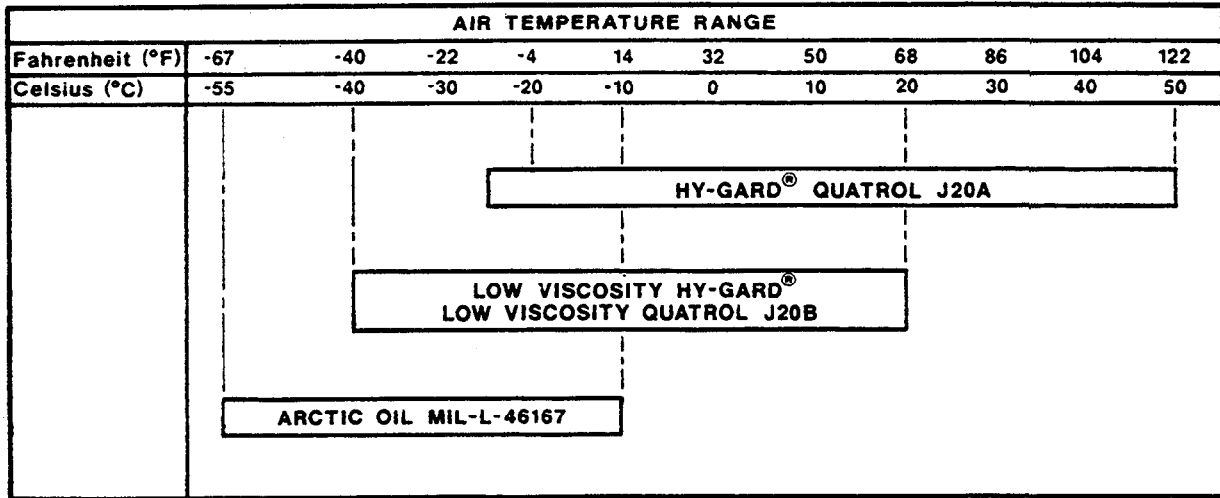

Depending on the expected air temperature range between oil changes, use oil viscosity shown on the chart above. John Deere HY-GARD® transmission and hydraulic oil is recommended.

You may also use QUATROL® oils, which are oils that meet John Deere standards, or other oils meeting John Deere Standard JDM J20A or J20B.

Oils meeting MIL-L-46167 may be used as arctic oil.

002;T5871AF T82;BHFL X 110385

GREASE FOR EXTENDIBLE DIPPERSTICK

SAE Multipurpose Grease with Extreme Pressure (EP) performance and containing 3 to 5 per cent molybdenum disulfide (preferred).

T82;BHFL D 030485

COLD WEATHER OPERATION

Additional information on cold weather operation is available from your John Deere Industrial Region office.

T82;TLPD U 270183

ALTERNATIVE LUBRICANTS

Conditions in certain geographical areas may require special lubricants and lubrication practices which do not appear in this manual. If you have any questions, consult your John Deere Industrial Region office to obtain the latest information and recommendations.

T82;TLPD Y 270183

LUBRICANT STORAGE

Your machine can operate at top efficiency only if clean lubricants are used. Use clean containers to handle all lubricants. Store them in an area protected from dust, moisture, and other contamination. Store drums on their sides.

T82;BHFL J 080483

Section 1 WHEELS

CONTENTS

GROUP 0110 - POWERED WHEELS AND FASTENINGS

| | |
|------------------------------|---------|
| Special Tools | 0110-01 |
| Wheel Specifications | 0110-01 |
| Remove Wheel Assembly | 0110-01 |
| Remove Tire | 0110-02 |
| Install Tire | 0110-03 |
| Install Wheel Assembly | 0110-04 |

GROUP 0120 - NON-POWERED WHEEL AND FASTENINGS

| | |
|------------------------------------|---------|
| Special Tools | 0120-01 |
| Wheel Specifications | 0120-01 |
| Remove Front Wheel Assembly | 0120-01 |
| Remove Tire | 0120-02 |
| Install Tire | 0120-03 |
| Install Front Wheel Assembly | 0120-05 |

T47;0100 03 08085

POWERED WHEELS AND FASTENINGS

SPECIAL TOOLS

NOTE: Order tools from your SERVICE-GARD™ Catalog, unless otherwise indicated.

| Number | Name | Use |
|-----------|-----------------------|---|
| D-01182A | 20-Ton Floor Stand | To support unit while removing and installing wheels. |
| D-05019ST | Heavy Duty Wheel Lift | To remove and install wheels. |

T47;0110 22 290683

WHEEL SPECIFICATIONS

1. Rear wheel cap screw torque

F-Grade cap screw 576 N·m (435 lb-ft)
 D-Grade cap screw 400 N·m (295 lb-ft)

Front wheel nut torque (MFWD) 407 N·m
 (300 lb-ft)

2. Tire operating pressure

| Size | Ply Rating | Pressure |
|---------|------------|---|
| 14/17.5 | 10 | 414 ± 13 kPa (4.1 ± 0.1 bar) (60 ± 2 psi) |
| 20.5/25 | 12 | 241 ± 34 kPa (2.4 ± 3.4 bar) (35 ± 50 psi) |
| 21L/24 | 10 | 179 ± 13 kPa (1.8 ± 0.1 bar) (26 ± 2 psi) |
| 21L-24 | 16 | 276 ± 13 kPa (2.8 ± 0.1 bar) (40 ± 2 psi) |

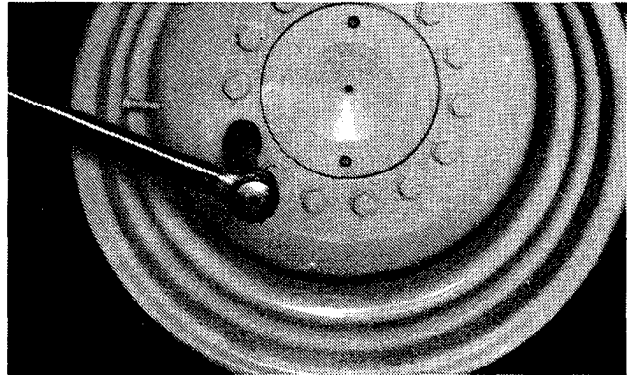

1AG;T93650 T47;0110 K269 080885

REMOVE WHEEL ASSEMBLY

⚠ CAUTION: Rear wheel weighs approximately 197 kg (435 lb).

1. Loosen cap screws or wheel nuts before lifting the wheel off the ground.

2. Raise unit and put D-01182A 20-Ton Floor Stand under main frame.



1AG;T93651 T47;0110 24 050885

3. Put the D-05019ST Heavy Duty Wheel Lift (A) under wheel. Fasten safety chain around the upper portion of tire.
4. Remove cap screws (B). Pull wheel assembly away from axle.
5. Inspect all parts for damage. Replace parts as necessary.

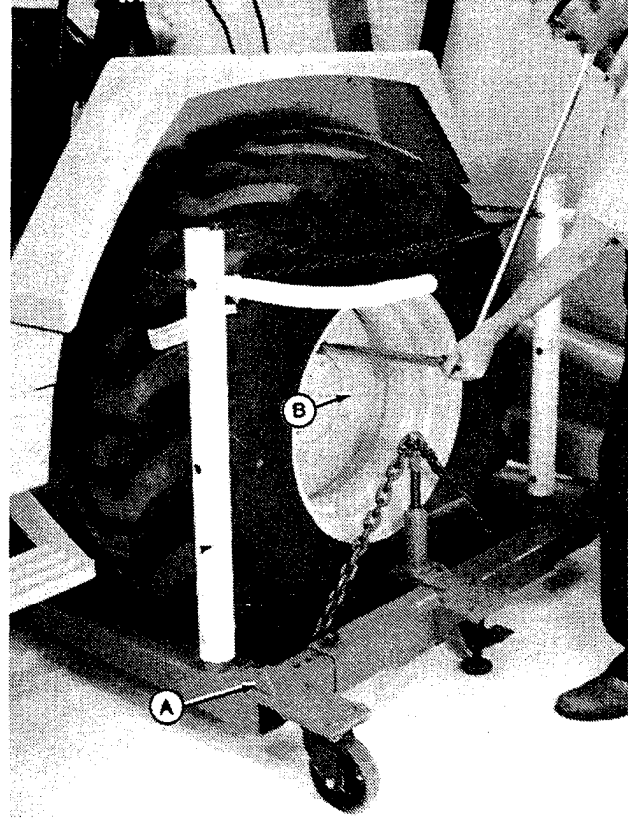

1AG;T93652 T47;0110 25 290683

REMOVE TIRE

1. The tire can be removed without removing the wheel from the machine. See the John Deere Off-The-Road Tire Maintenance Manual to remove the tire from the wheel.



CAUTION: Failure to follow proper procedures when demounting a tire from a wheel or rim can produce an explosion which may result in serious bodily injury. **DO NOT** attempt to demount a tire unless you have the proper equipment and experience to perform the job safely. Have it done by a qualified tire repair service.

T47;0110 26 121283

2. Always completely deflate the tire by removing the valve core (A) from valve before attempting any demounting operation. Check the valve stem by running a probe through it to make sure the valve stem is not plugged. Remove valve nut (B).

3. Inspect all parts for damage; replace parts as necessary.

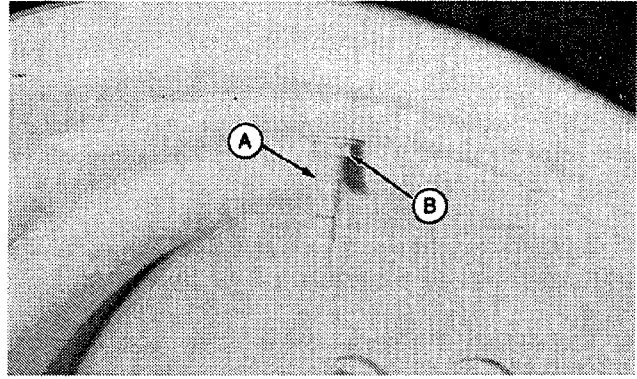

1AG;T93653 T47;0110 27 290683

INSTALL TIRE

CAUTION: Failure to follow proper procedure when mounting a tire on a wheel or rim, can produce an explosion which may result in serious bodily injury. DO NOT attempt to mount a tire unless you have the proper equipment and experience to perform the job safely. Have it done by a qualified tire repair service.

NOTE: See the John Deere Off-The-Road Tire Maintenance Manual to mount the tire on the wheel.

1. Make sure all parts are clean and free from rust or grease before assembly.
2. To prevent slipping of the wheel under load, the inside and outside of wheel (A) must be free of paint, rust, oil, grease, dirt or other foreign material before installation.
3. Install valve stem (B) in rim base and tighten valve core housing finger tight.

CAUTION: Serious bodily injury can occur from explosion when mounting and inflating tires if safe procedures are not followed.

4. Before mounting tire on rim, add soap lubricant to beads of the tire (C).

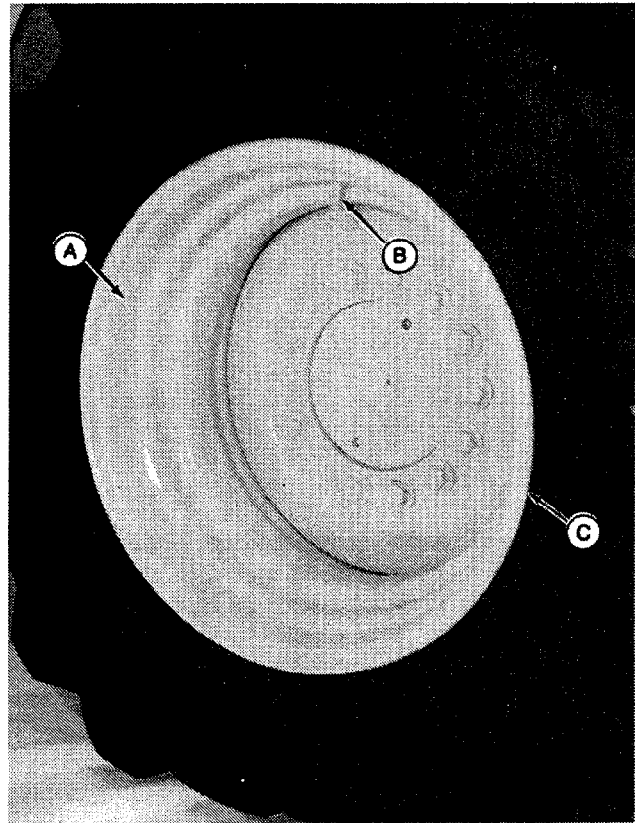

1AG;T93654 T47;0110 28 290683

5. Clear the area of all persons.
6. Turn tire so valve stem is pointing down. Use a pressure regulating valve (A) with clip-on chuck and extension hose long enough to allow you to stand to one side and NOT in front of tire while inflating.
7. Use only recommended air pressure. Pressure over this limit can cause an explosion.
8. Add air until side flange of tire slides out against the rim.

TIRE OPERATING PRESSURE

| Size | Ply Rating | Pressure |
|---------|------------|--|
| 14/17.5 | 10 | 414 ± 13 kPa (4.1 ± 0.1 bar) (60 ± 2 psi) |
| 20.5/25 | 12 | 241 ± 344 kPa (2.4 ± 3.4 bar) (35 ± 50 psi) |
| 21L/24 | 10 | 179 ± 13 kPa (1.8 ± 0.1 bar) (26 ± 2 psi) |
| 21L-24 | 16 | 276 ± 13 kPa (2.8 ± 0.1 bar) (40 ± 2 psi) |

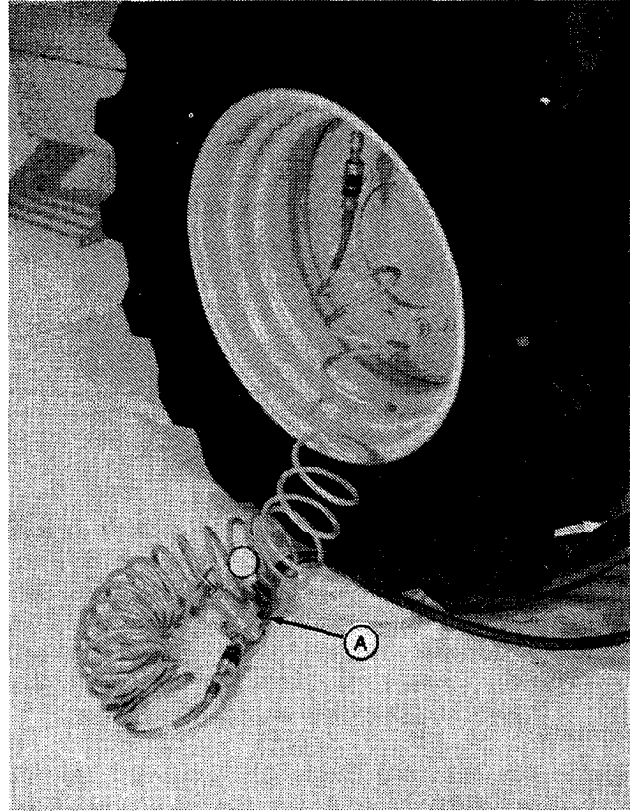

1AG;T93655 T47;0110 29 080885

INSTALL ASSEMBLY

1. Thoroughly clean the cap screws or wheel nuts, washers and the tapped holes in the flanged axle or axle studs. Use compressed air to dry all parts and tapped holes.
2. Install wheel using wheel lift (A).
3. Install cap screws or wheel nuts (B).
4. Tighten cap screws or wheel nuts to 200 ± 20 N·m (148 ± 15 lb-ft).

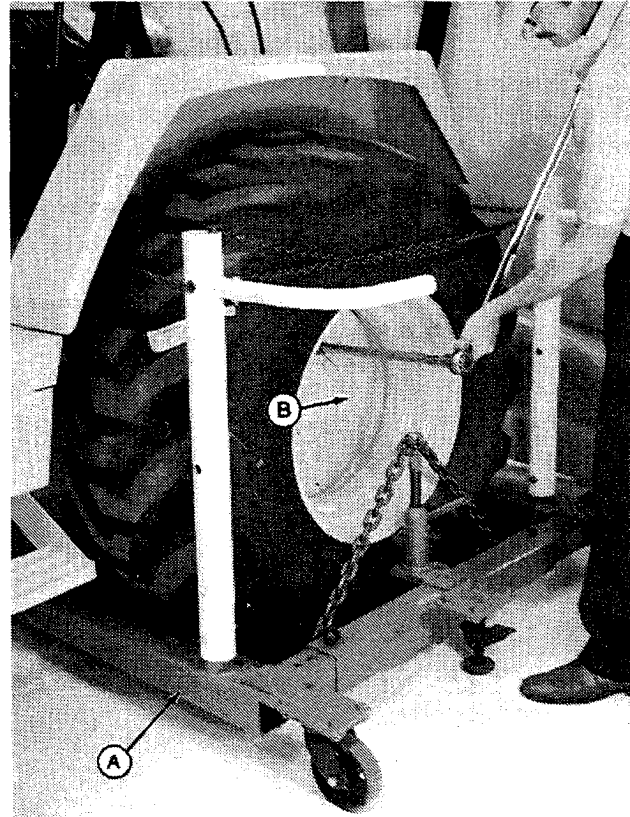

1AG;T93656 T47;0110 30 080885

5. Lower unit to the ground.

IMPORTANT: If a power wrench is used, be sure that the cap screws are engaged to prevent stripping. Operate the wrench slowly to prevent thread damage.

6. Cross tighten F-grade rear wheel cap screws to 576 N·m (425 lb-ft).

Cross tighten D-grade rear wheel cap screws to 400 N·m (295 lb-ft).

Cross tighten the front wheel nuts (MFWD only) to 300 N·m (221 lb-ft).

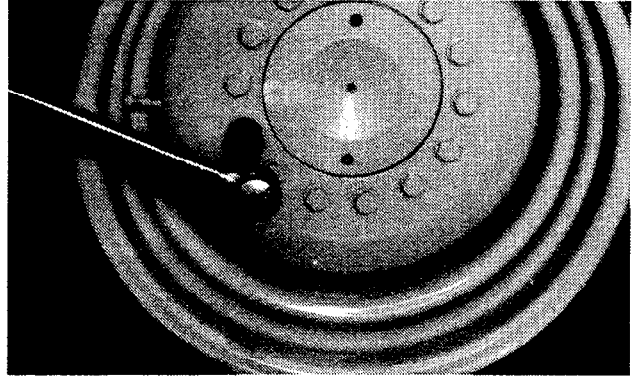

1AG;T93650 T47;0110 K270 080885

NON-POWERED WHEELS AND FASTENINGS

SPECIAL TOOLS

NOTE: Order tools from your SERVICE-GARD™ Catalog, unless otherwise indicated.

| Number | Name | Use |
|-----------|-----------------------|---|
| D-01182A | 20-Ton Floor Stand | To support unit while removing and installing wheels. |
| D-05019ST | Heavy Duty Wheel Lift | To remove and install wheels. |

T47;0120 25 290683

WHEEL SPECIFICATIONS

1. Cap screw torque 230 + 35 - 46 N·m
(170 + 26 - 34 lb-ft)
2. Tire operating pressure; 10 ply 276 kPa
(40 psi)

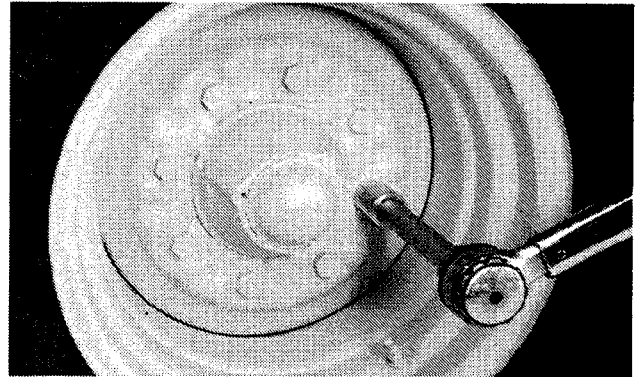

1AG;T93645 T47;0120 26 130484

REMOVE FRONT WHEEL ASSEMBLY

⚠ CAUTION: Front wheel weighs approximately 84.4 kg (186.1 lb) without fluid, 364.4 kg (466.1 lb) with fluid.

1. Loosen cap screws before lifting wheel off the ground.
2. Put a floor stand such as D-01182A 20-Ton Floor Stand under axle housing.

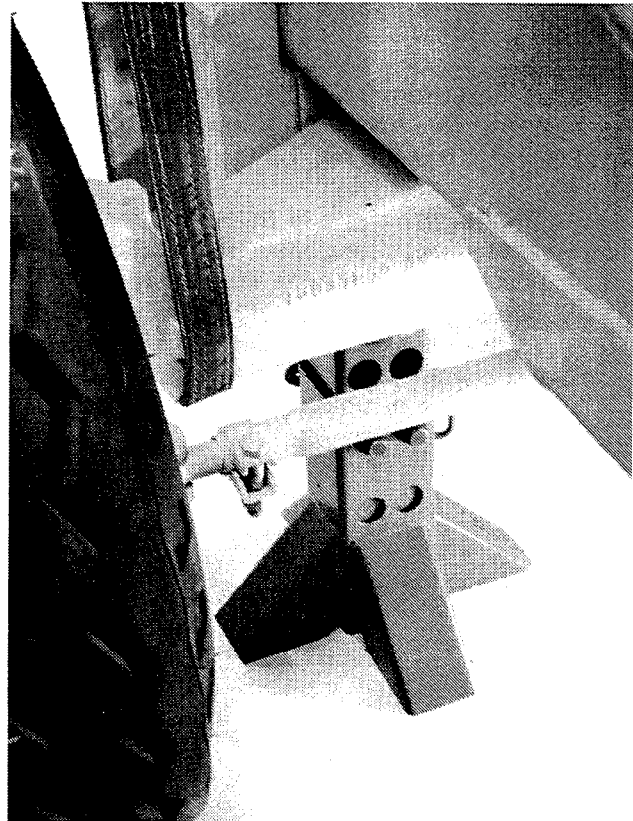

1AG;T93646 T47;0120 27 050484

3. Put D-05019ST Wheel Lift (A) under wheel. Fasten safety chain around the upper portion of tire.
4. Remove the cap screws (B). Pull wheel assembly away from axle.
5. Inspect all parts for damage. Replace parts as necessary.

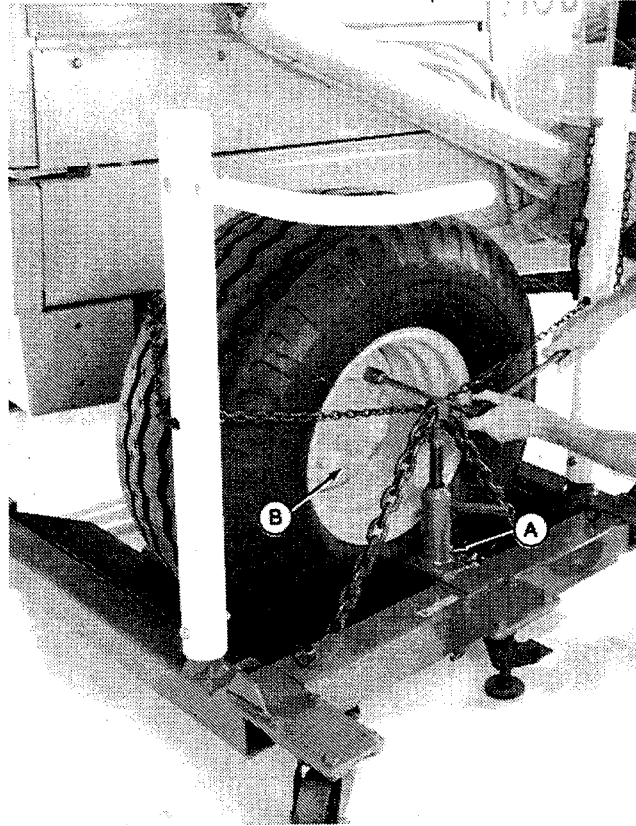

1AG;T93647 T47;0120 28 290683

REMOVE TIRE

1. The tire can be removed without removing the wheel from the machine. See the John Deere Off-The-Road Tire Maintenance Manual to remove the tire from the wheel.

⚠ CAUTION: Failure to follow proper procedures when demounting a tire from a wheel or rim can produce an explosion which may result in serious bodily injury. **DO NOT** attempt to demount a tire unless you have the proper equipment and experience to perform the job safely. Have it done by a qualified tire repair service.

T47;0120 29 290683

2. Always completely deflate the tire by removing the valve core (A) from valve before attempting any demounting operation. Check the valve stem by running a probe through it to make sure the valve stem is not plugged. Remove valve nut (B).

3. Inspect all parts for damage; replace parts as necessary.

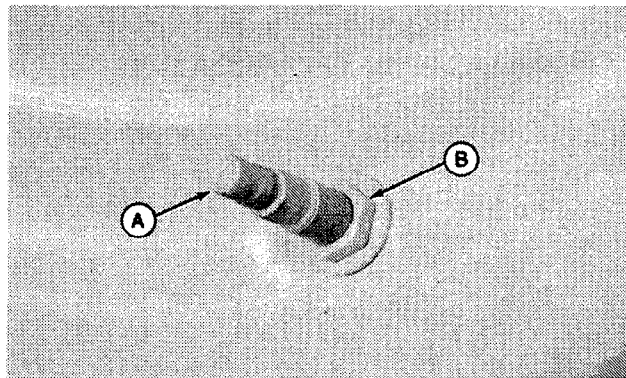

1AG;T91801 T47;0120 30 290683

INSTALL TIRE



CAUTION: Failure to follow proper procedures when mounting a tire on a wheel or rim, can produce an explosion which may result in serious bodily injury. **DO NOT** attempt to mount a tire unless you have the proper equipment and experience to perform the job safely. Have it done by a qualified tire repair service.

NOTE: See the John Deere Off-The-Road Tire Maintenance Manual to mount the tire on the wheel.

1. Make sure all parts are clean and free from rust or grease before assembly.

T47;0120 31 290683

DIFFERENTIAL DRIVE SHAFT QUILL RETAINING SCREW SPECIFICATION

Cap screw torque 50 N·m (37 lb-ft) plus
90° (¼ turn)

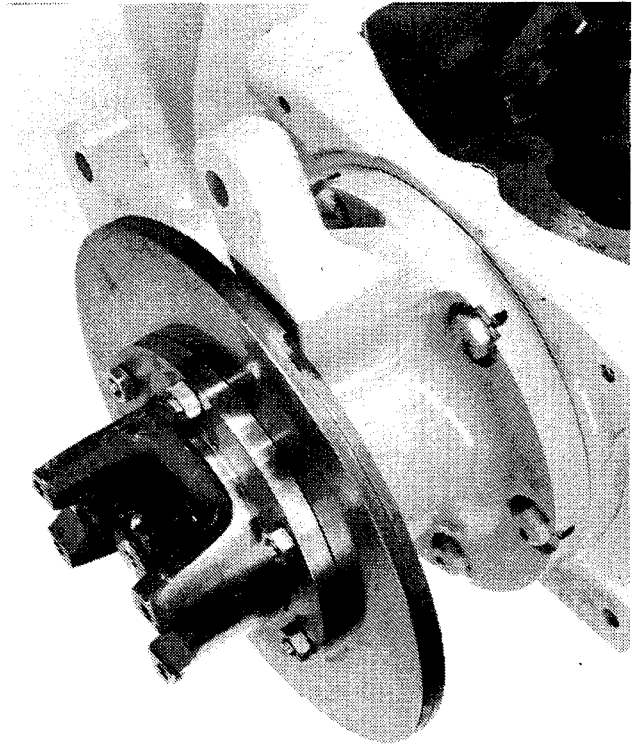

0AA;T94267 R50;50300 482 010883

DIFFERENTIAL HOUSING COVER CAP SCREW SPECIFICATION

Cap screw torque 75 N·m
(55 lb-ft)

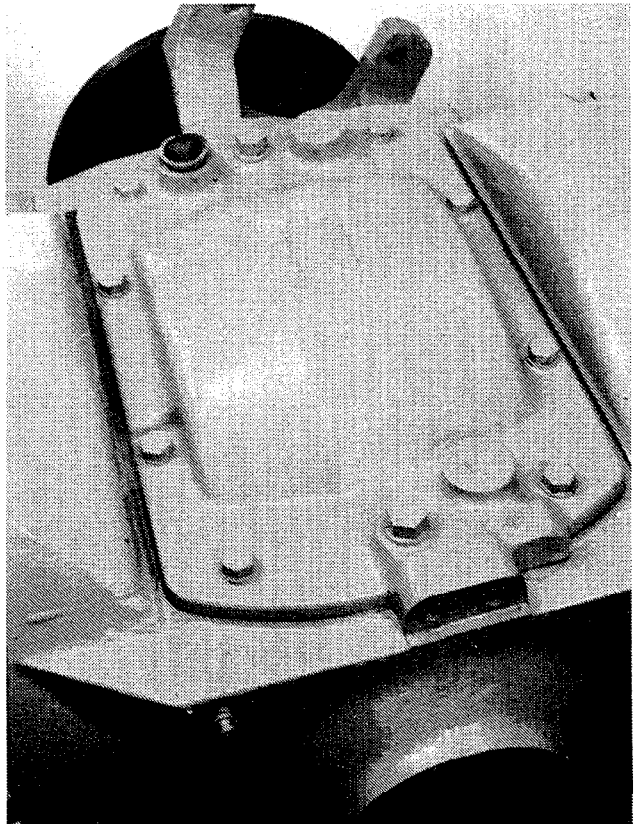

0AA;T94268 R50;50300 483 031283

Non-Powered Wheels and Fastenings

| Tire Size | Type | Ply Rating | Operating Pressure |
|-----------------|------|------------|--------------------|
| 14.5/75 16.1 | F3 | 10 | 276 kPa (40 psi) |

T47;0120 34 290683

INSTALL FRONT WHEEL ASSEMBLY

1. Thoroughly clean the cap screws, washers and the tapped holes. Use compressed air to dry all parts and tapped holes.
2. Install the wheel assembly using D-05019ST Wheel Lift (B) and install cap screws (A).
3. Tighten cap screws to 115 N·m (85 lb-ft).
4. Lower tractor to ground.

IMPORTANT: If a power wrench is used, be sure that the cap screws are engaged to prevent stripping. Operate the wrench slowly to prevent thread damage.

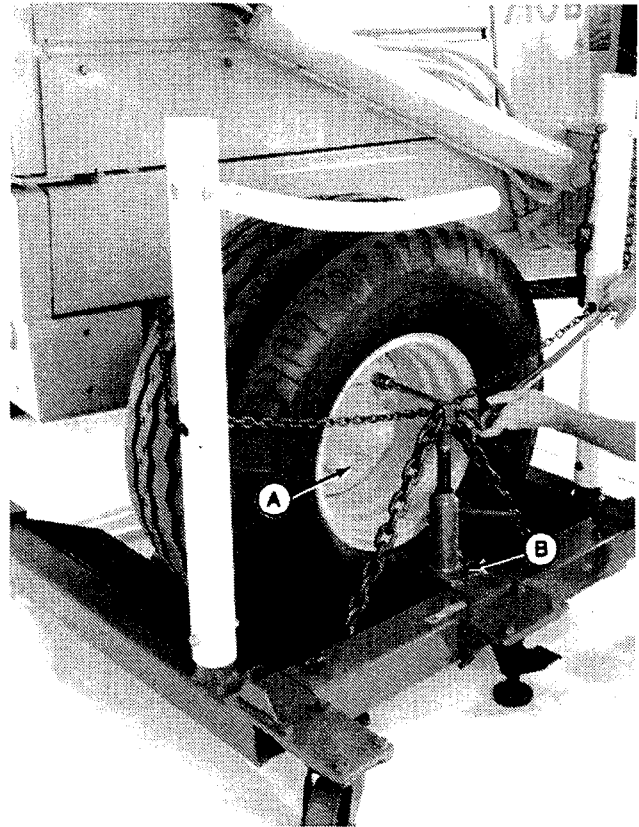

1AG;T93649 T47;0120 35 290683

5. Cross tighten the cap screws to 230 + 35 – 46 N·m (170 + 26 – 34 lb-ft).

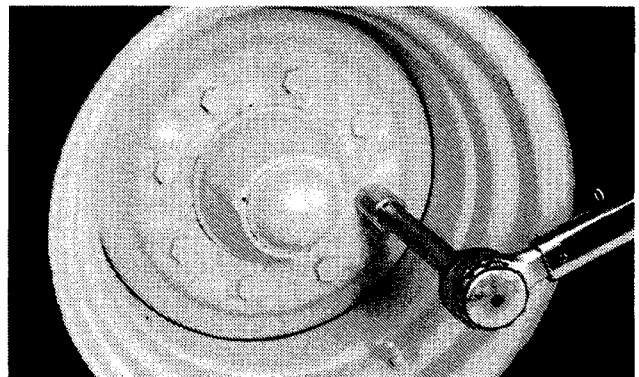

1AG;T93645 T47;0120 37 130484

Section 02

AXLES AND SUSPENSION SYSTEM

CONTENTS

| | Page | | Page |
|---|---------|--|---------|
| GROUP 0200—REMOVAL AND INSTALLATION | | GROUP 0225—INPUT DRIVE SHAFT AND U-JOINTS | |
| Special Tools | 0200-03 | Specifications | 0225-01 |
| Specifications | | Differential Drive Shaft | |
| Universal Mounting Arm to Case | 0200-03 | Remove and Install | 0225-01 |
| Axle to Frame | 0200-03 | | |
| Drive Shaft | 0200-04 | | |
| Bar to Axle Mount | 0200-04 | | |
| Differential and Axle Assembly | | GROUP 0230—NON-POWERED WHEEL AXLES | |
| Remove | 0200-04 | Special Tools | 0230-01 |
| Install | 0200-07 | Other Material | 0230-01 |
| | | Specifications | |
| GROUP 0210—DIFFERENTIAL OR BEVEL DRIVE | | Toe-In | 0230-01 |
| Special Tools | 0210-01 | Tie Rod | 0230-01 |
| Other Materials | 0210-01 | Hub Assembly | |
| Specifications | 0210-02 | Remove | 0230-02 |
| Differential Disassembly | | Install | 0230-07 |
| Remove Differential Drive Shaft | | Adjust Wheel Hub Assembly | 0230-08 |
| and Bearing Quill | 0210-07 | Spindle and Knuckle Assembly | |
| Disassemble Differential Drive Shaft ... | 0210-07 | Remove | 0230-03 |
| Remove Differential Housing | 0210-10 | Install | 0230-05 |
| Disassemble Differential Housing | 0210-12 | Tie Rod | |
| Differential Assembly | | Remove | 0230-09 |
| Assemble Differential Housing | 0210-18 | Install | 0230-10 |
| Install Differential Housing | 0210-23 | Non-Powered Front Axle | |
| Adjust Differential Housing Preload ... | 0210-24 | Remove | 0230-11 |
| Assemble Differential Drive Shaft | 0210-26 | Install | 0230-14 |
| Adjust Cone Point | 0210-27 | Toe-In Adjustment | 0230-16 |
| Assemble Differential Input Quill | 0210-29 | Axle Bushings | |
| Adjust Differential Drive Shaft | 0210-30 | Remove and Install | 0230-12 |
| Final Assembly of Differential Drive Shaft | | | |
| and Bearing Quill | 0210-32 | | |
| Install Differential Drive Shaft | | | |
| and Bearing Quill | 0210-33 | | |
| Adjust Differential Backlash | 0210-34 | | |
| Checking Bearing Pattern | 0210-34 | | |
| Final Assembly of Differential Housing . | 0210-35 | | |
| Test Differential Lock Assembly | | | |
| Oil | 0210-37 | | |
| Air | 0210-38 | | |

Continued on next page

CONTENTS—Continued

| | Page | | Page |
|--|---------|--------------------------------------|---------|
| GROUP 0240—POWERED WHEEL AXLE (MFWD) | | GROUP 0260—HYDRAULIC SYSTEM | |
| Essential Tools | 0240-01 | Special Tools | 0260-01 |
| Service Equipment and Tools | 0240-01 | Specifications | |
| Other Material | 0240-02 | Differential Lock Valve Spring | 0260-01 |
| Specifications | | Differential Lock Valve | |
| Powered Front Axle | 0240-03 | Remove and Install | 0260-02 |
| Drive Shaft | | Disassemble | 0260-04 |
| Remove and Disassemble | 0240-04 | Assemble | 0260-06 |
| Assemble and Install | 0240-05 | | |
| Powered Front Axle | | | |
| Remove | 0240-06 | | |
| Install | 0240-07 | | |
| Disassemble Knuckle Housing and Wheel Hub with Planetary Drive ... | 0240-09 | | |
| Disassemble Axle Shaft and Constant Velocity Joint | 0240-13 | | |
| Assemble Axle Shaft and Constant Velocity Joint | 0240-14 | | |
| Remove Differential | 0240-15 | | |
| Disassemble Differential | 0240-15 | | |
| Assemble Differential | 0240-21 | | |
| Install Differential | 0240-31 | | |
| Assemble and Adjust Knuckle Housing and Wheel Hub with Planetary | 0240-32 | | |
| Adjust Toe-In | 0240-38 | | |
| GROUP 0250—AXLE SHAFT, BEARINGS, AND REDUCTION GEARS | | | |
| Special Tools | 0250-01 | | |
| Specifications | 0250-01 | | |
| Axle Housing Disassembly | | | |
| Remove Planet Pinion Carrier | 0250-02 | | |
| Disassemble Planet Pinion Carrier | 0250-02 | | |
| Assemble Planet Pinion Carrier | 0250-03 | | |
| Remove Axle Shaft | 0250-03 | | |
| Axle Housing Assembly | | | |
| Assemble Axle Shaft and Housing | 0250-05 | | |
| Adjust Axle Bearings | 0250-07 | | |
| Install Brake Disk and Brake Backing Plate | 0250-10 | | |

T47:0200 C45 180685

SPECIAL TOOLS

NOTE: Order tools from your SERVICE-GARD™ Catalog, unless otherwise indicated.

| Number | Name | Use |
|-----------|----------------------------|---|
| JT01642 | Low-Lift Transmission Jack | Remove and install differential and axle assembly. |
| D-01004AA | Universal Mounting Arm | Use with Low-Lift Transmission Jack to remove and install transmission. |

T47;0200 03 060484

UNIVERSAL MOUNTING ARM TO CASE CAP SCREW SPECIFICATIONS

Differential quill cap screw (A) torque (2 used) . . . 50 N·m
(37 lb-ft)

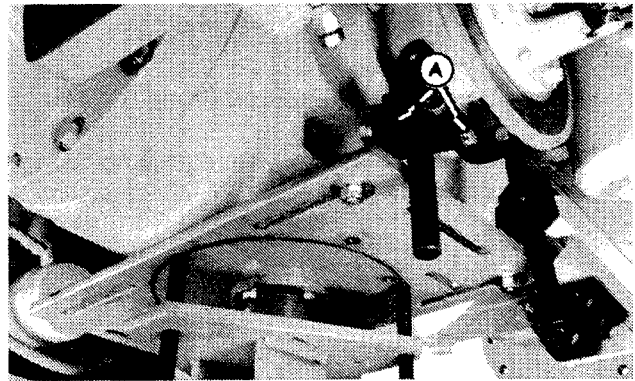

5AG;T94238 T47;0200 04 250783

AXLE TO FRAME SPECIFICATIONS

Cap screw torque (8 used) 916 ± 147 N·m
(676 ± 108 lb-ft)

Torque in following sequence: front inside, rear outside, rear inside, and front outside.

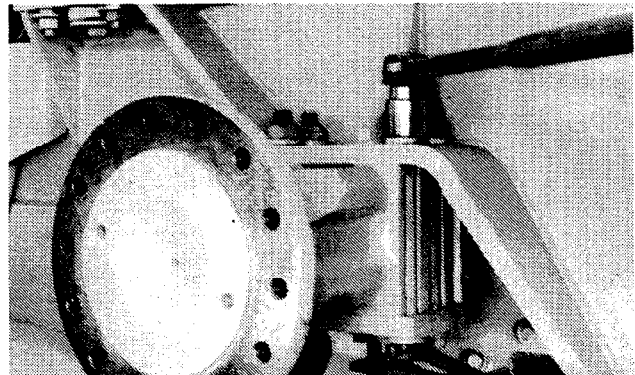

5AG;T94239 T47;0200 05 250783

DRIVE SHAFT SPECIFICATIONS

Cap screw (A) torque (4 used) 36.5 ± 4 N·m
(27 ± 3 lb-ft)

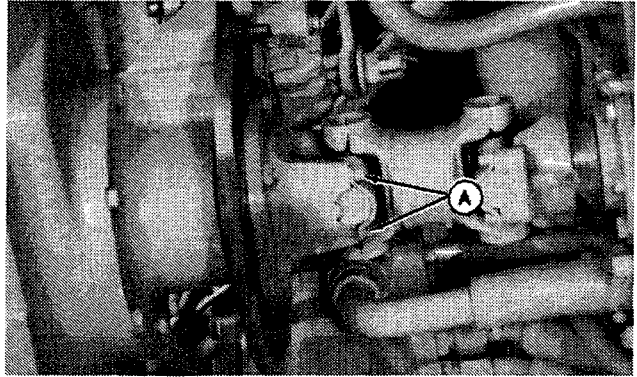

5AG;T94240 T47;0200 06 250783

BAR TO AXLE MOUNT SPECIFICATIONS

Nut torque (16 used) 530 ± 85 N·m
(391 ± 63 lb-ft)

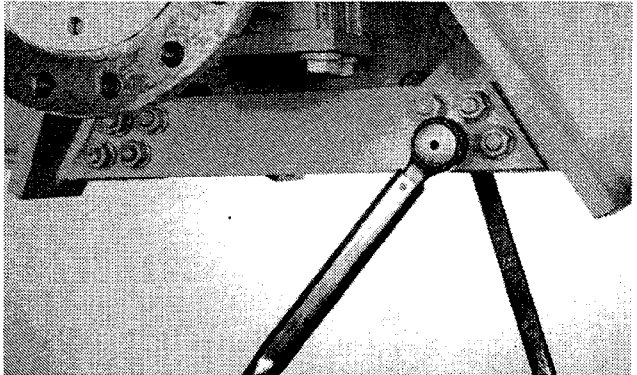

5AG;T94241 T47;0200 07 250783

RAISE UNIT TO REMOVE DIFFERENTIAL

1. Remove both rear wheels. (See Group 0110.)

NOTE: The bottom of the main frame must be 533 mm (21 in.) plus the lowered height of service jacking device used.

2. Raise unit to install four shop stands such as D-24206WK 10 Ton Shop Stand.

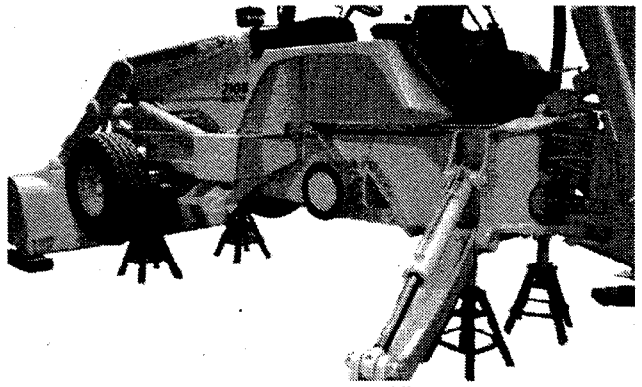

5AG;T94242 T47;0200 08 250783

NOTE: Differential hydraulic oil capacity is approximately 20 liters (4.5 gallons).

3. Remove drain plug (A) to drain differential oil. Install plug.

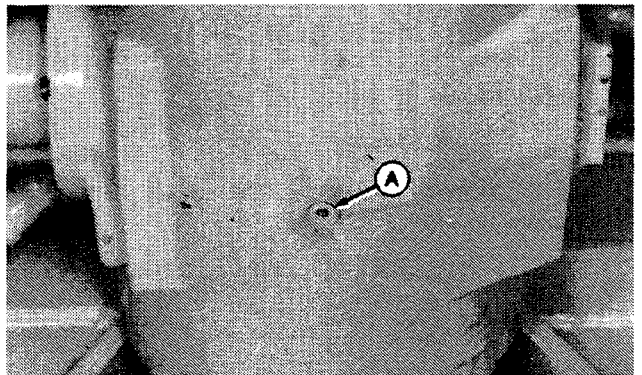

5AG;T94243 T47;0200 09 250783

4. Remove cap screws to remove two bars from each side.

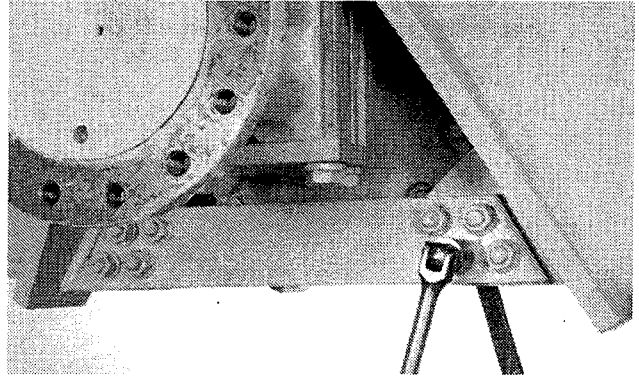

5AG:T94244 T47:0200 10 250783

DISCONNECT DRIVE SHAFT, PARKING BRAKE, AND HYDRAULIC LINES

1. Remove cap screws (C) to disconnect drive shaft.
2. Remove nut (B) to disconnect parking brake.

⚠ CAUTION: Escaping fluid under pressure can penetrate the skin causing serious injury. Relieve pressure before disconnecting hydraulic or other lines. Tighten all connections before applying pressure. Keep hands and body away from pinholes and nozzles which eject fluids under high pressure. Use a piece of cardboard or paper to search for leaks. **DO NOT** use your hand.

If ANY fluid is injected into the skin, it must be surgically removed within a few hours by a doctor familiar with this type injury or gangrene may result.

3. Operate all control valves to release pressure in hydraulic system.
4. Put identification tags on all hydraulic lines to aid in assembly.
5. Disconnect left (D) and right (A) brake lines.
6. Close all openings with caps and plugs to keep dirt out of the hydraulic system.

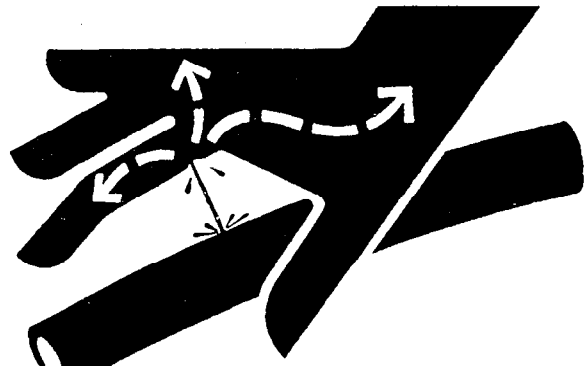
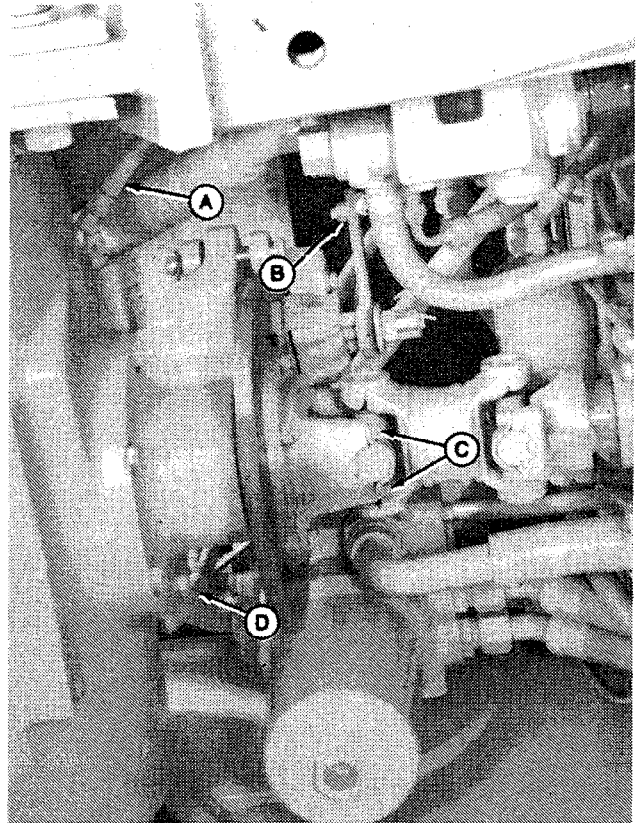

A—Right Brake Line
B—Nut

C—Cap Screw (4 used)
D—Left Brake Line

5AG:T94245, X9811 T47:0200 11 250783

Removal and Installation

7. Disconnect differential lock lines (A and B).

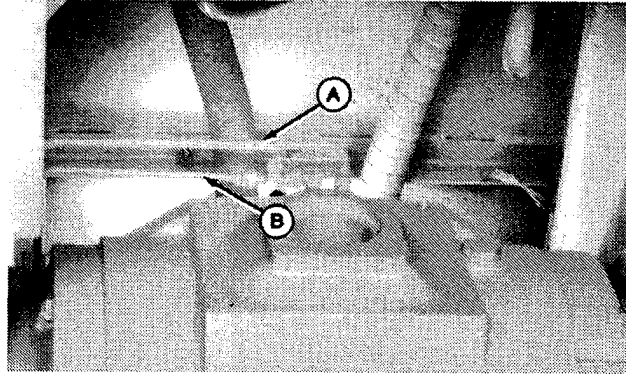

5AG;T94246 T47;0200 12 250783

CAUTION: Differential assembly with both axles weighs approximately 643 kg (1,417 lb).

8. Install JT01642 Low-Lift Transmission Jack under differential.

9. Remove one cap screw from each side of quill and install two D-01004AA Universal Mounting Arms (B). Install and tighten two cap screws (A) to 50 N·m (37 lb-ft).

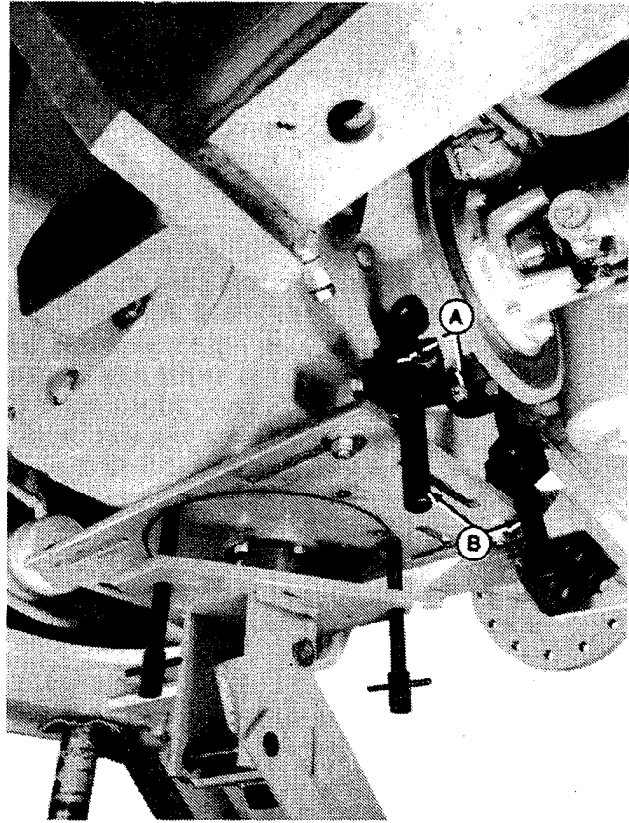

5AG;T94247 T47;0200 13 060484

10. Remove cap screws and plate (A) from each side.

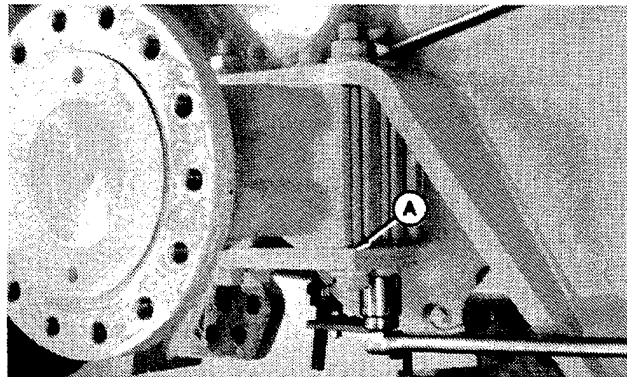

5AG;T94248 T47;0200 14 250783

Removal and Installation

11. Carefully lower differential and axle assembly. Remove from unit.

12. Put wooden blocks under one axle for support.

⚠ CAUTION: Each axle assembly weighs approximately 157 kg (345 lbs).

13. Attach axle to a hoist using a lifting strap. Remove axle.

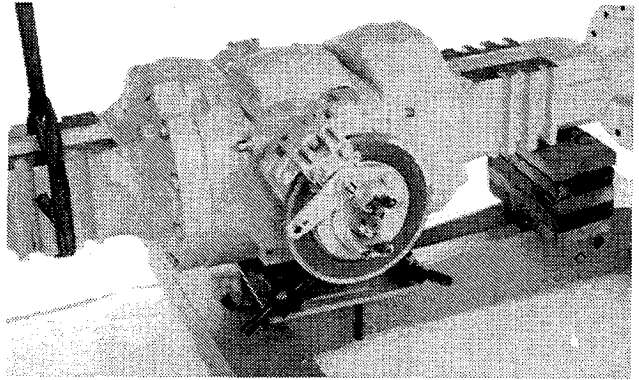

5AG:T94249 T47:0200 15 250783

INSTALL DIFFERENTIAL AND AXLE ASSEMBLY

1. Attach axle assembly to a hoist using a lifting strap.

2. Install axle.

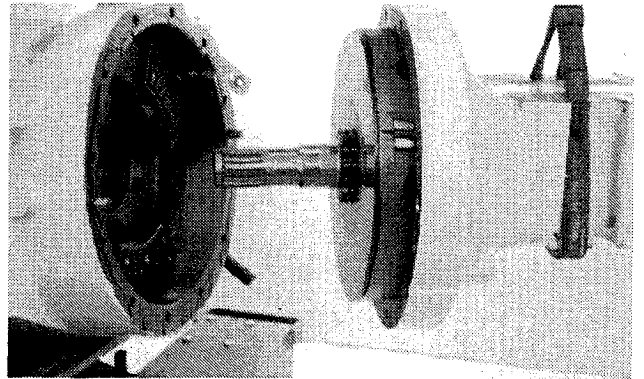

5AG:T94250 T47:0200 16 250783

3. Position differential and axle assembly under unit and carefully raise assembly.

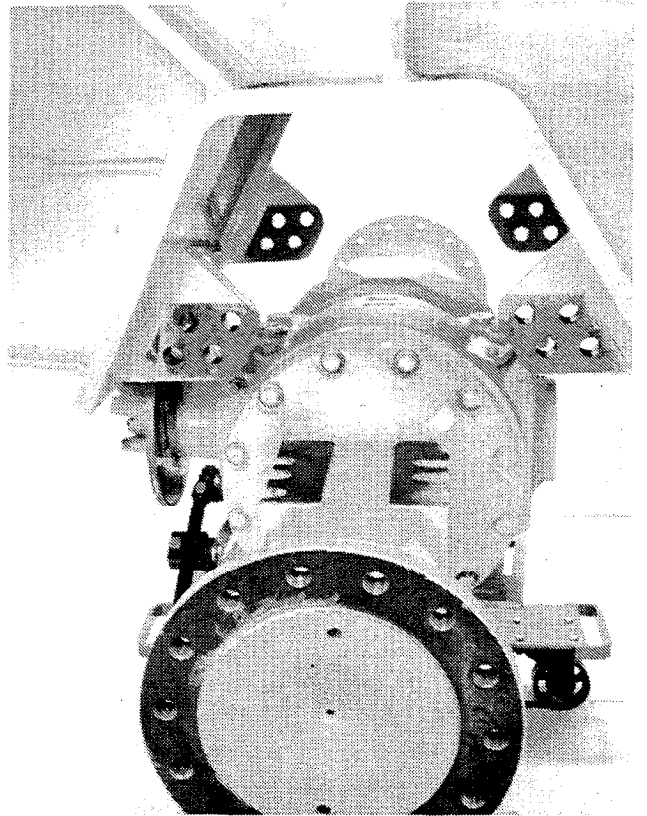

5AG:T94251 T47:0200 17 250783

Removal and Installation

4. Put SAE 30 oil on threads of cap screws (B). Install one plate (A) and four cap screws and nuts on each side. Tighten nuts in the following sequence to 916 ± 147 N·m (676 ± 108 lb-ft): front inside, rear outside, rear inside, and front outside.

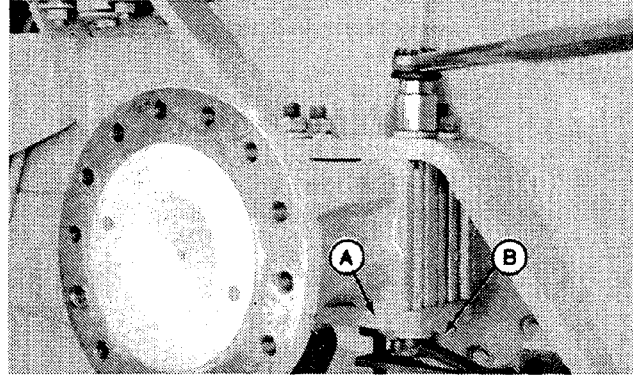

5AG;T94252 T47;0200 18 250783

5. Connect differential lock lines (A and B).

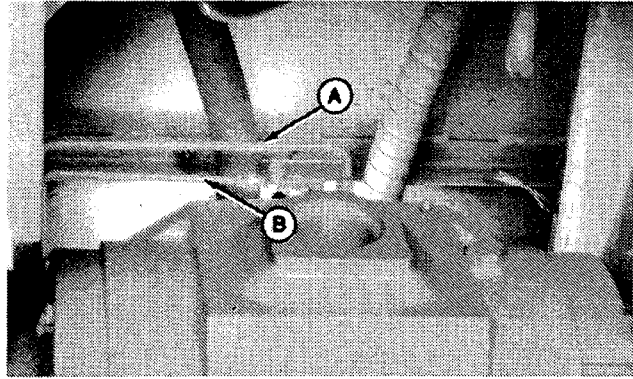

5AG;T94246 T47;0200 19 250783

6. Connect left (D) and right (A) brake lines.
7. Install and tighten nut (B) to connect parking brake.
8. Connect pump drive shaft. Install and tighten cap screws (C) to 36.5 ± 4 N·m (27 ± 3 lb-ft).

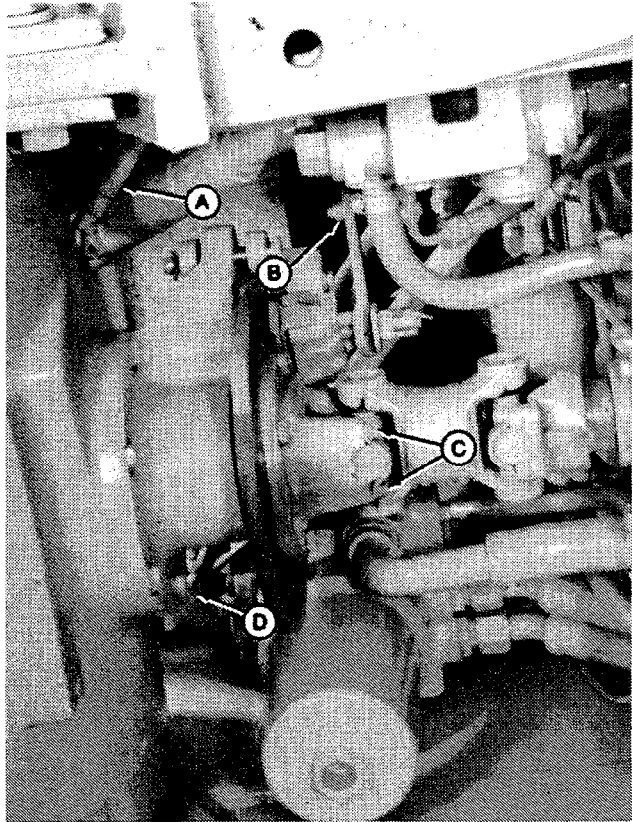

A—Right Brake Line
B—Nut

C—Cap Screw (4 used)
D—Left Brake Line

5AG;T94245 T47;0200 20 250783

Removal and Installation

9. Put SAE 30W oil on cap screw threads. Install two plates and eight cap screws and nuts on each side of tractor. Tighten nuts to 530 ± 85 N·m (391 ± 63 lb-ft).

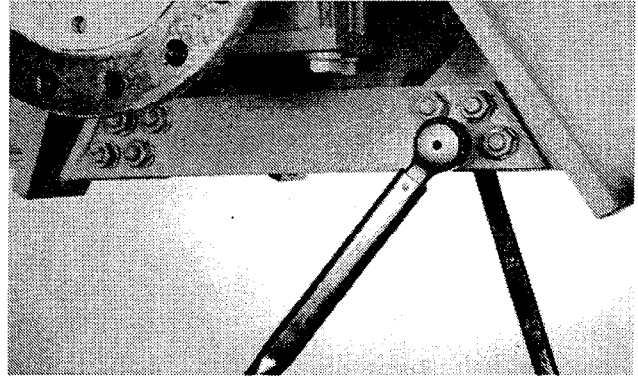

5AG;T94241 T47;0200 21 250783

LOWER UNIT

1. Remove shop stands from under unit.
2. Carefully lower unit to the ground.
3. Install engine side shields and hood. (See Group 1910.)
4. Install both rear wheels.
5. Adjust parking brake. (See Group 9020.)
6. Bleed the service brakes. (See Group 9025.)
7. Fill differential with the recommended oil (Section I, Group IV). Oil capacity is approximately 20 liters (4.5 gallons).

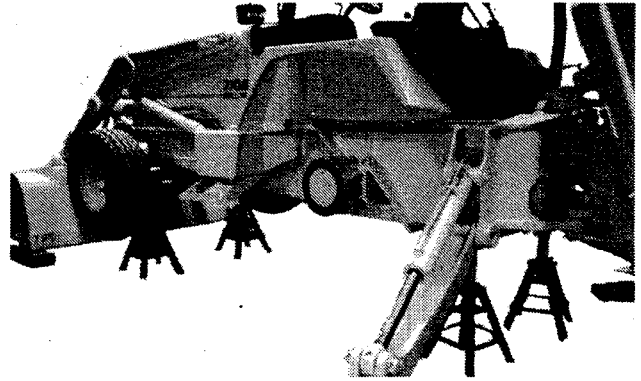

5AG;T94242 T47;0200 22 250783

Group 0210
DIFFERENTIAL OR BEVEL DRIVE

SPECIAL TOOLS

NOTE: Order tools from your SERVICE-GARD™ Catalog, unless otherwise indicated.

| Number | Name | Use |
|-----------|--|---|
| D-01045AA | Bushing, Bearing and Seal Driver Set | To install bearing cups. |
| D-01047AA | 17-1/2 and 30 Ton Puller Set | To remove oil seals, bearing cups, and cones. |
| D-01290AA | Mechanic Puller | To remove differential drive shaft bearing cups. |
| D-01215AA | Internal Puller | Used with mechanical puller to remove bearing cups. |
| D-01080AA | Hydraulic Analyzer | Hoses used with utility equipment accessory kit and universal pressure test kit to test differential lock assembly. |
| D-01085AA | Utility Equipment Accessory Kit | To test differential lock assembly. |
| D-15028NU | Universal Pressure Test Kit | To test differential lock assembly. |
| JDG-88 | Bearing Cup Installer | To install bearing cups. |
| JDG-185 | Air Test Plug | To test for air leaks in differential lock assembly. |
| JD-320 | Hydrostatic Motor Shaft Seal Installation Tool | To install oil seal. |

T47;0210 01 170484

OTHER MATERIALS

| Number | Name | Use |
|--------|---|------------------------|
| T43511 | John Deere LOCTITE® Clean and Cure Primer | On outer seal bore. |
| T43513 | John Deere LOCTITE Thread Lock and Sealer | On outer seal surface. |

LOCTITE is a trademark of the Loctite Corporation

R50;50300 477 031283

DIFFERENTIAL HOUSING PRELOAD SPECIFICATION

Preload 0.05—0.10 mm
(0.002—0.004 in.)

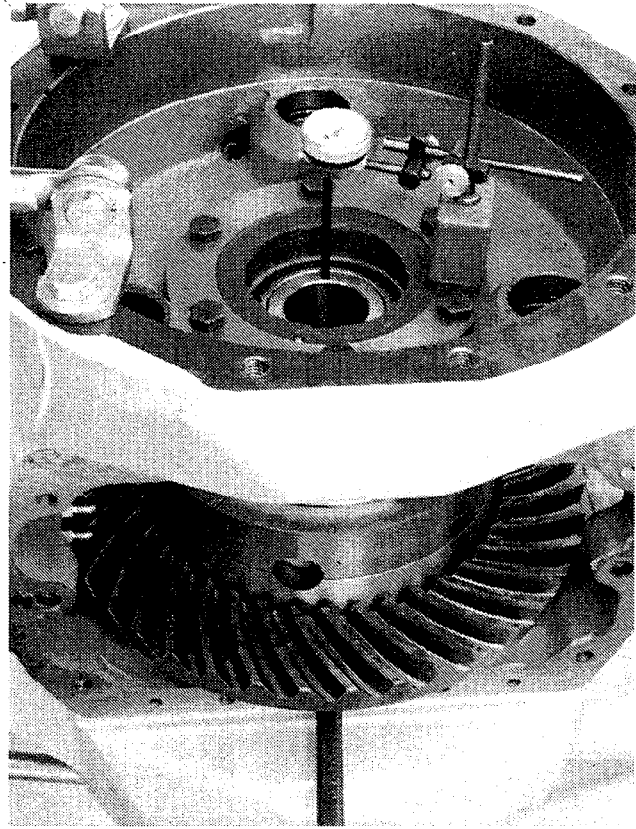

0AA;T94263 R50;50300 478 010883

DIFFERENTIAL DRIVE SHAFT-TO-RING GEAR BACKLASH SPECIFICATION

Backlash 0.2—0.4 mm
(0.008—0.016 in.)

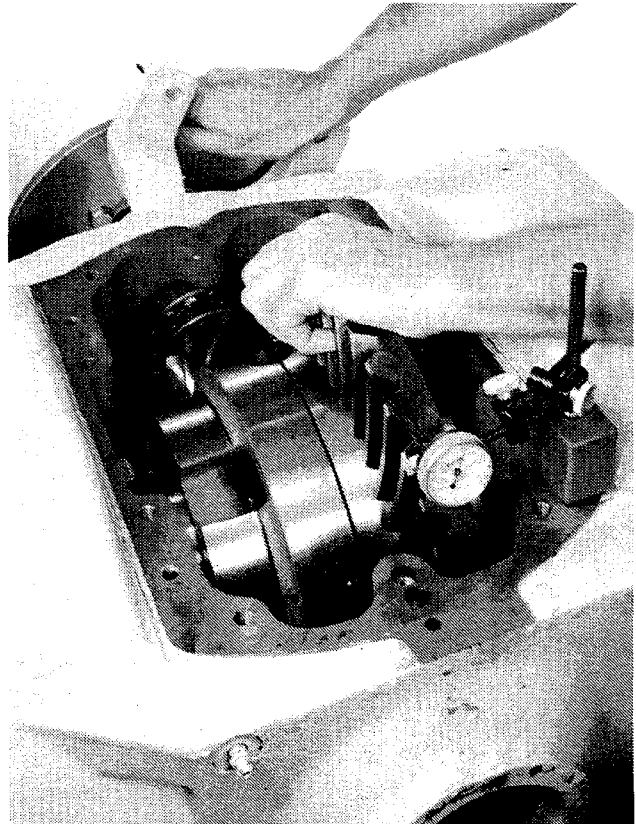

0AA;T94264 R50;50300 479 010883



Suggest:

If the above button click is invalid.

Please download this document

first, and then click the above link

to download the complete manual.

Thank you so much for reading

DIFFERENTIAL BEARING QUILL SCREW SPECIFICATION

Cap screw (A) torque 108 N·m (80 lb-ft)

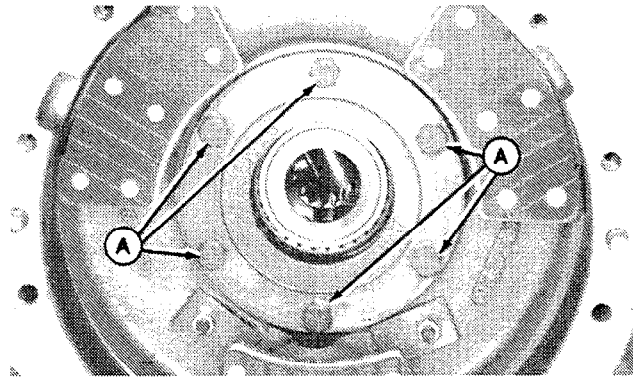

OAA;R37790 R50;50300 403 010883

DIFFERENTIAL LOCK LINE CONNECTOR SPECIFICATIONS

Connectors torque (C) 14 N·m
(10 lb-ft)

Differential lock line torque (A and B) 14 N·m
(10 lb-ft)

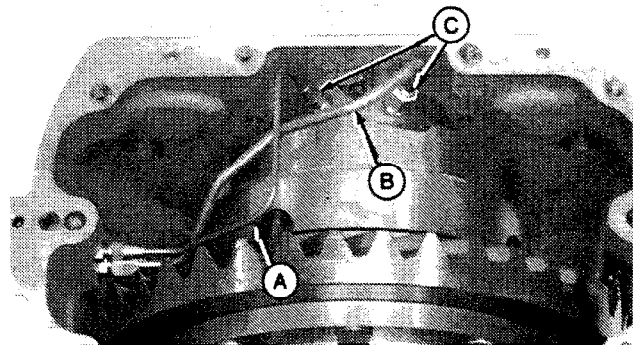

OAA;R37788 R50;50300 404 010883

DIFFERENTIAL DRIVE SHAFT ROLLING DRAG TORQUE SPECIFICATION

Rolling drag torque 0.2—1.1 N·m
(2—10 lb-in)

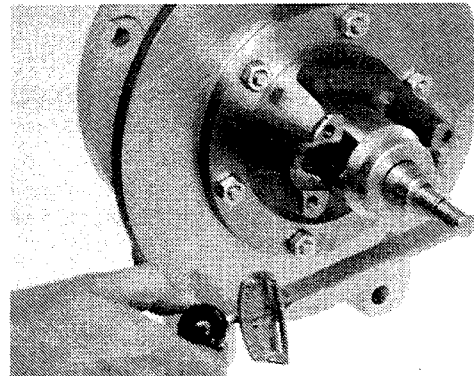

OAA;T94265 R50;50300 480 010883

DIFFERENTIAL DRIVE SHAFT NUT SPECIFICATION

Nut torque 305—405 N·m
(225—300 lb-ft)

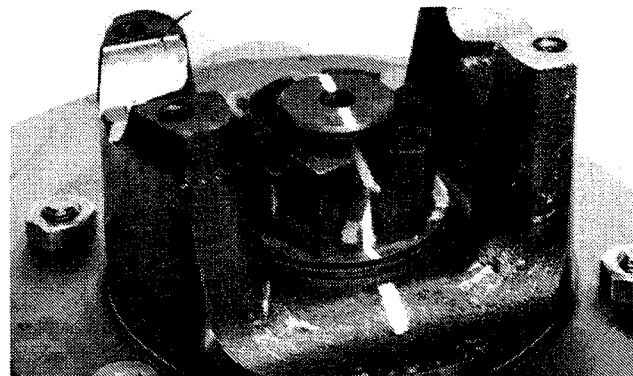

OAA;T94266 R50;50300 481 010883

<https://www.ebooklibonline.com>

Hello dear friend!

Thank you very much for reading.

Enter the link into your browser.

The full manual is available for immediate download.

<https://www.ebooklibonline.com>