

# 655 Crawler Loader

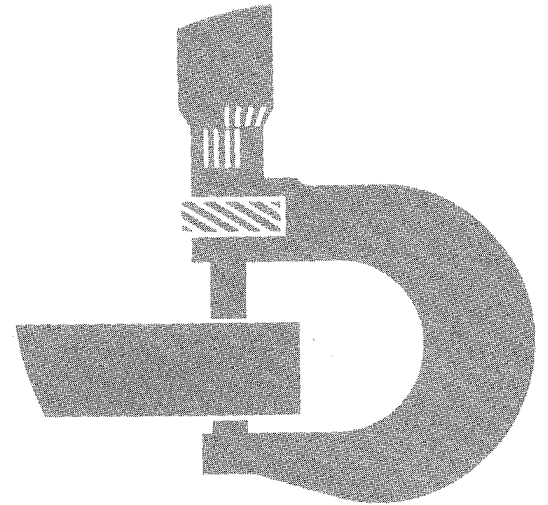

## TECHNICAL MANUAL

TM-(1250) (Apr-87)

LITHO IN U.S.A.

**655 CRAWLER LOADER  
Technical Manual  
TM-1250 (Apr-81)**

**SECTION AND GROUP CONTENTS OF THIS MANUAL**

**SECTION I - GENERAL INFORMATION**

- Group I - Contents, Index and Page List
- Group II - Introduction and Safety Information
- Group III - General Specifications
- Group IV - Lubrication

**SECTION 1 - TRACKS**

- Group 0130 - Track Systems
- Group 0199 - Specifications and Special Tools

**SECTION 2 - AXLES AND SUSPENSION  
SYSTEMS**

- Group 0201 - Drive Axle Housing
- Group 0250 - Axle Shaft, Bearings and Reduction Gears
- Group 0299 - Specifications and Special Tools

**SECTION 3 - TRANSMISSION**

- Group 0315 - Controls
- Group 0325 - Input Drive Shafts and U-Joints
- Group 0360 - Hydraulic System
- Group 0370 - Clutch Disconnect and Controls
- Group 0399 - Specifications and Special Tools

**SECTION 4 - ENGINE**

- Group 0400 - Removal and Installation
- Group 0401 - Crankshaft and Main Bearings
- Group 0402 - Camshaft and Valve Actuating Means
- Group 0403 - Connecting Rods and Pistons
- Group 0404 - Cylinder Block
- Group 0407 - Oiling System
- Group 0408 - Ventilating System
- Group 0409 - Cylinder Head and Valves
- Group 0410 - Exhaust Manifold
- Group 0413 - Fuel Injection System
- Group 0416 - Turbocharger
- Group 0417 - Water Pump
- Group 0418 - Thermostats, Housings, and Water Piping
- Group 0419 - Oil Cooler
- Group 0420 - Fuel Filter
- Group 0421 - Fuel Transfer Pump
- Group 0422 - Starting Motor and Fastenings
- Group 0429 - Fan Drive
- Group 0433 - Flywheel, Housing and Fastenings
- Group 0499 - Specifications and Special Tools

**SECTION 5 - ENGINE AUXILIARY SYSTEMS**

- Group 0505 - Cold Weather Starting Aids
- Group 0510 - Cooling System
- Group 0515 - Speed Controls
- Group 0520 - Intake System
- Group 0530 - External Exhaust System
- Group 0540 - Mounting Frame
- Group 0560 - External Fuel Supply System
- Group 0599 - Specifications and Special Tools

**SECTION 8 - TRANSFER DRIVE**

- Group 0841 - Housing and Covers
- Group 0851 - Gears, Shafts, Bearings
- Group 0899 - Specifications and Special Tools

**SECTION 11 - PARKING EMERGENCY BRAKE**

- Group 1111 - Active Elements
- Group 1115 - Controls Linkage
- Group 1160 - Hydraulic System
- Group 1199 - Specifications and Special Tools

**SECTION 15 - EQUIPMENT ATTACHING**

- Group 1511 - Drawbar
- Group 1512 - Towbar

**SECTION 16 - ELECTRICAL SYSTEMS**

- Group 1671 - Batteries, Supports and Cables
- Group 1672 - Alternator, Regulator and Charging System Wiring
- Group 1673 - Lighting System
- Group 1674 - Wiring Harness and Switches
- Group 1675 - System Controls
- Group 1676 - Instruments and Indicators
- Group 1699 - Specifications and Special Tools

**SECTION 17 - FRAME, CHASSIS OR SUPPORT-  
ING STRUCTURE**

- Group 1740 - Frame Installation
- Group 1746 - Frame Bottom Guards
- Group 1749 - Chassis Weights

**SECTION 18 - OPERATOR'S STATION**

- Group 1810 - Operator Enclosure
- Group 1821 - Seat and Seat Belt
- Group 1830 - Heating and Air Conditioning
- Group 1899 - Specifications and Special Tools

Copyright © 1981  
DEERE & COMPANY  
Moline, Illinois  
All Rights Reserved

## SECTION AND GROUP CONTENTS OF THIS MANUAL—Continued

### SECTION 19 - SHEET METAL AND STYLING

- Group 1910 - Hood or Engine Enclosures
- Group 1921 - Grille and Grille Housing

### SECTION 20 - SAFETY, CONVENIENCE AND MISCELLANEOUS

- Group 2003 - Fire Extinguisher
- Group 2004 - Horn and Warning Devices
- Group 2006 - Cigar Lighter

### SECTION 31 - LOADER

- Group 3102 - Buckets
- Group 3115 - Controls Linkage
- Group 3140 - Frames
- Group 3160 - Hydraulic System
- Group 3199 - Specifications and Special Tools

### SECTION 42 - GROUND CONDITIONING TOOL

- Group 4201 - Blades, Teeth, Shanks
- Group 4215 - Controls Linkage
- Group 4260 - Hydraulic System

### SECTION 90 - SYSTEM TESTING

- Group 9005 - General Information - Seven Basic Steps of Testing and Diagnosis
- Group 9010 - Engine
- Group 9015 - Electrical System
- Group 9020 - Power Train
- Group 9025 - Hydraulic System (Flow Meter)
- Group 9025A - Hydraulic System (Analyzer)
- Group 9026 - Hydrostatic System
- Group 9030 - Miscellaneous Components
- Group 9031 - Heating and Air Conditioning
- Group 9035 - Specifications and Special Tools

*The specifications and design information contained in this manual were correct at the time it was printed. It is John Deere's policy to continually improve and update our machines. Therefore, the specifications and design information are subject to change without notice. Wherever applicable, specifications and design information are in accordance with SAE and ICED standards.*

**<https://www.ebooklibonline.com>**

Hello dear friend!

Thank you very much for reading.

Enter the link into your browser.

The full manual is available for immediate download.

**<https://www.ebooklibonline.com>**

## ALPHABETICAL INDEX

<b>A</b>	
Adjustment, hydrostatic system .....	9026-90
Air circulation blower motor .....	1830-30
Air conditioning operational test .....	9031-17
Air conditioning relay .....	1674-4
Air conditioning system .....	1830-5
Air conditioning system .....	9031-2
Diagnosis and testing .....	9031-5
Air conditioning system service .....	9031-9
Adding refrigerant-12 to system .....	9031-15
Charging the system .....	9031-13
Component location .....	9031-19
Discharging the system .....	9031-10
Electrical system .....	9031-9
Evacuating the system .....	9031-11
Flushing the system .....	9031-10
Inspecting refrigerant hoses and tubing ..	9031-16
Installing manifold gauge set .....	9031-9
Leak testing .....	9031-16
Manifold gauge set .....	9031-9
Purging the system .....	9031-11
Alternator .....	1672-1
Alternator and regulator, 16 amp .....	1672-13
Alternator, regulator, 42 amp .....	1672-1
Automatic control valve shutoff, transmission .....	0315-13
Valve control .....	0315-13
Return-to-neutral linkage .....	0315-14
Automatic control valve variable, transmission .....	0315-10
Automatic system control .....	1675-1
Axle housing .....	0201-3
Axle shaft, bearings and reduction gears .....	0250-1
<b>B</b>	
Batteries .....	1671-3
Battery cables .....	1671-3
Battery disconnect .....	1674-2
Battery supports .....	1671-3
Blades, shanks, teeth, ground conditioning tool .....	4201-3
Bottom guards, frame .....	1746-1
Buckets, loader .....	3102-3
<b>C</b>	
Cab .....	1810-3
Camshaft .....	0402-1
Carrier rollers .....	0130-4
Charging system wiring .....	1672-1
Cigar lighter .....	2006-1
Circuit protectors .....	1674-3
Clutch coil and housing .....	1830-15
Cold weather starting aids .....	0505-3
Compressor .....	1830-5
Compressor hub and drive plate assembly ..	1830-8
Compressor pulley and bearing .....	1830-14
Compressor relief valve .....	1830-27
Compressor shaft seal .....	1830-10
Condenser .....	1830-21
Connecting rods .....	0403-1
Control valve, loader .....	3160-12
Controls linkage, ground conditioning tool .....	4215-1
Controls linkage, loader .....	3115-1
Counterweight .....	1749-1
Cowl .....	1910-4
Crankshaft .....	0401-1
Cylinder block .....	0404-1
Cylinder head and valves .....	0409-1
Cylinders, loader .....	3160-16
<b>D</b>	
Diagnosing malfunctions, hydrostatic system .....	9026-31
Diagnosing malfunctions, miscellaneous components .....	9031-1
Double selector valve .....	4260-1
Double selector valve control linkage .....	4215-1
Drawbar .....	1511-3
<b>E</b>	
Electric wiring harness .....	1674-1
Electrical systems .....	1671-1
Engine system testing .....	9010-1
Component location .....	9010-15
Diagnosing malfunction .....	9010-2
General information .....	9010-1
Testing and adjustments .....	9010-7
Air intake system .....	9010-12
Alternator and fan belts adjustments ...	9010-9
Basic engine .....	9010-7
Engine cooling system .....	9010-8
Engine lubrication system .....	9010-7
Engine output check .....	9010-8
Engine output check turbocharger pressure test .....	9010-12
Fuel system .....	9010-9
Speed control linkage .....	9010-11
Visual inspection .....	9010-5
Electrical system testing .....	9015-1
Complete electrical schematic .....	9015-27
Complete electrical wiring diagram .....	9015-28
Component location .....	9015-31



Instruments and indicators, electrical	1676-4
Instruments and indicators, mechanical	1676-1
Intake system, engine	0520-1
Introduction	I-II-1

**L**

Leakage test, tracks	0130-67
Lights	1673-1
Light switch	1673-2
Lighting system	1673-1
Loader buckets	3102-3
Loader controls linkage	3115-1
Loader control valve	3160-12
Loader cylinders	3160-16
Loader frames	3140-1
Loader hydraulics	3160-2
Loader reservoir	3160-6
Loader reservoir and filters	3160-6
Lubrication	I-IV-1

**M**

Main bearings	0401-1
Main frame	1741-3
Mounting frame	0540-1

**O**

Oil cooler, engine	0419-1
Oil filters and housing	0407-3
Oil pressure regulating valve	0407-2
Oiling system	0407-1
Oil pump	0407-1
Operator enclosure	1810-3
Orifice linkage, transmission	0315-10

**P**

Parking emergency brake active elements	1111-3
Parking emergency brake control linkage	1115-1
Parking brake hydraulics	1160-1
Pistons	0403-1
Planet housings with pinions and shafts	0250-2
Power train system testing	
Component location	9020-7
Diagnosing malfunctions	9020-3
General information	9020-1
Power train block diagram	9020-2
Testing and adjustments	9020-5
Engine disconnect clutch	9020-5
Visual inspection	9020-4

**R**

Receiver-dryer	1830-23
Recoil spring	0130-59

Regulator	1672-1
Relay, air conditioning	1674-4
Relay, starting circuit	1674-4
Reservoir, loader	3160-6
Reverse warning alarm	2004-2
Ripper	4201-3
Rock guards	0130-3
ROPS (w/windshield)	1810-6
ROPS (without cab)	1810-7

**S**

Seat	1821-1
Sheet metal and styling	1910-1
Solenoid, starting aid	0505-3
Special tools	
Air conditioning system	1899-3
Alternator, regulator and charging system wiring	1699-7
Batteries, supports and cables	1699-6
Camshaft and valve actuating means	0499-25
Clutch disconnect and controls	0399-20
Connecting rods and pistons	0499-26
Crankshaft and main bearing	0499-24
Cylinder block	0499-28
Cylinder head and valves	0499-31
Drive axle housing	0299-3
Engine removal and installation	0499-23
Fuel injection system	0499-33
Hydraulic system	0399-12
Loader frames	3199-6
Loader hydraulics	3199-6
Starting system	0499-39
System testing	9035-1
Track systems	0199-1
Turbocharger	0499-36
Water pump	0499-38

Specification

Active elements, parking brake	1199-1
Air conditioning system	1899-1
Alternator, regulator and charging system wiring	1699-1
Axle shafts, bearings and reduction gears	0299-2
Batteries, supports and cables	1699-1
Buckets, loader	3199-1
Camshaft and valve actuating means	0499-3
Clutch disconnect and controls	0399-11
Cold weather starting aid	0599-1
Connecting rods and pistons	0499-8
Crankshaft and main bearings	0499-2
Cylinder block	0499-9
Cylinder head and valves	0499-13
Drive axle housing	0299-1

Specifications—Continued

Engine break-in	0499-1
Engine cooling system	0599-1
Engine oil cooler	0499-18
External fuel supply system	0599-2
Fan drive	0499-22
Flywheel, housing and fasteners	0499-22
Fuel injection system	0499-15
Hydraulic system, parking brake	1199-2
Hydraulics systems	0399-2
Input drive shafts and U-joints	0399-1
Instruments and indicators	1699-5
Loader hydraulics	3199-1
Mounting frame	0599-2
Oiling system	0499-10
Speed controls	0599-1
Starting system	0499-19
System testing	9035-1
Thermostats, housings and piping	0499-17
Track systems	0199-1
Transfer drive gears, shafts, bearings	0899-1
Turbocharger	0499-16
Vehicle lighting system	1699-4
Water pump	0499-17
Wiring harness and switches	1699-4
Speed control support, transmission	0315-12
Speed controls, engine	0515-1
Sprocket	0130-65
Starting aid adapter	0505-4
Starting aid line	0505-4
Starting aid nozzle	0505-4
Starting aid solenoid	0505-3
Starting aid switch	0505-3
Starting circuit relay	1674-4
Starting motor and fastenings	0422-1
Steering linkage, transmission	0315-3
Switch, light	1673-2
Switch, neutral start	1674-4
Switch, starting aid	0505-3
Switch, thermostatic temperature control	1830-26

T

Testing and adjustments

Miscellaneous components	9030-2
Carrier roller alignment	9030-3
Front idler guides	9030-3
Inner guide adjustment (vertical)	9030-3
Outer guide adjustment (horizontal)	9030-3
Track tension	9030-2
Windshield wiper	9030-4
Thermal fuse and superheat shut-off switch	1830-28
Thermostats, housings and piping	0418-1

Thermostatic temperature control switch	1830-26
Towbar	1512-1
Track adjuster cylinder	0130-57
Track chain assembly	0130-30
Track frame	0130-61
Track frame wear strips	0130-63
Track guides	0130-3
Track roller and idler leakage test	0130-67
Track rollers	0130-15
Track shoes	0130-29
Track systems	0130-1
Transfer drive gears, shafts, bearings	0851-1
Transfer drive housing and covers	0841-3
Transmission	0315-1
Transmission bypass valve	0360-50
Transmission charge pump	0360-48
Transmission clutch disconnect and controls	0370-1
Transmission control valve	0360-95
Transmission control valve system testing	9026-14
Transmission controls	0315-3
Transmission displacement control valve	0360-80
Transmission filter	0360-132
Transmission forward and reverse speed control	0315-7
Control head	0315-8
Control linkage	0315-10
Transmission input drive shafts and U-joints	0325-1
Transmission manifold valve assembly	0360-92
Transmission motor	0360-52
Transmission oil cooler	0360-126
Transmission oil cooler bypass valve	0360-127
Transmission operating pressure valve	0360-129
Transmission orifice linkage	0315-10
Transmission pump displacement control valve	0360-36
Transmission reservoir	0360-131
Transmission speed control support	0315-12
Transmission steering linkage	0315-3
Transmission vacuum relief valve	0360-133
Turbocharger	0416-1

V

Valve, actuating means	0402-1
Valve, double selector	4260-1
Valve, loader control	3160-12
Valve, oil pressure regulating	0407-2
Ventilating system	0408-1

W

Water pump	0417-1
Windshield washer	1910-9
Windshield wiper, front	1810-8
Windshield wiper, rear	1810-9

**COMPLETE PAGE LISTING  
WITH LATEST DATE LINES**

I-I-1,2	(Apr-81)	2-0201-1,2	(Apr-81)	3-0360-63,64	(Apr-81)
I-I-3,4	(Apr-81)	2-0201-3,4	(Apr-81)	3-0360-65,66	(Apr-81)
I-I-5,6	(Apr-81)	2-0201-5,6	(Apr-81)	3-0360-67,68	(Apr-81)
I-I-7,8	(Apr-81)	2-0250-1,2	(Apr-81)	3-0360-69,70	(Apr-81)
I-I-9,10	(Apr-81)	2-0250-3,4	(Apr-81)	3-0360-71,72	(Apr-81)
I-II-1,2	(Apr-81)	2-0250-5,6	(Apr-81)	3-0360-73,74	(Apr-81)
I-II-3,4	(Apr-81)	2-0250-7,8	(Apr-81)	3-0360-75,76	(Apr-81)
I-II-5,6	(Apr-81)	2-0250-9,10	(Apr-81)	3-0360-77,78	(Apr-81)
I-III-1,2	(Apr-81)	2-0250-11,12	(Apr-81)	3-0360-79,80	(Apr-81)
I-III-3,4	(Apr-81)	2-0250-13,14	(Apr-81)	3-0360-81,82	(Apr-81)
I-IV-1,2	(Apr-81)	2-0299-1,2	(Apr-81)	3-0360-83,84	(Apr-81)
		2-0299-3,4	(Apr-81)	3-0360-85,86	(Apr-81)
1-0130-1,2	(Apr-81)			3-0360-87,88	(Apr-81)
1-0130-3,4	(Apr-81)	3-0315-1,2	(Apr-81)	3-0360-89,90	(Apr-81)
1-0130-5,6	(Apr-81)	3-0315-3,4	(Apr-81)	3-0360-91,92	(Apr-81)
1-0130-7,8	(Apr-81)	3-0315-5,6	(Apr-81)	3-0360-93,94	(Apr-81)
1-0130-9,10	(Apr-81)	3-0315-7,8	(Apr-81)	3-0360-95,96	(Apr-81)
1-0130-11,12	(Apr-81)	3-0315-9,10	(Apr-81)	3-0360-97,98	(Apr-81)
1-0130-13,14	(Apr-81)	3-0315-11,12	(Apr-81)	3-0360-99,100	(Apr-81)
1-0130-15,16	(Apr-81)	3-0315-13,14	(Apr-81)	3-0360-101,102	(Apr-81)
1-0130-17,18	(Apr-81)	3-0325-1,2	(Apr-81)	3-0360-103,104	(Apr-81)
1-0130-19,20	(Apr-81)	3-0360-1,2	(Apr-81)	3-0360-105,106	(Apr-81)
1-0130-21,22	(Apr-81)	3-0360-3,4	(Apr-81)	3-0360-107,108	(Apr-81)
1-0130-23,24	(Apr-81)	3-0360-5,6	(Apr-81)	3-0360-109,110	(Apr-81)
1-0130-25,26	(Apr-81)	3-0360-7,8	(Apr-81)	3-0360-111,112	(Apr-81)
1-0130-27,28	(Apr-81)	3-0360-9,10	(Apr-81)	3-0360-113,114	(Apr-81)
1-0130-29,30	(Apr-81)	3-0360-11,12	(Apr-81)	3-0360-115,116	(Apr-81)
1-0130-31,32	(Apr-81)	3-0360-13,14	(Apr-81)	3-0360-117,118	(Apr-81)
1-0130-33,34	(Apr-81)	3-0360-15,16	(Apr-81)	3-0360-119,120	(Apr-81)
1-0130-35,36	(Apr-81)	3-0360-17,18	(Apr-81)	3-0360-121,122	(Apr-81)
1-0130-37,38	(Apr-81)	3-0360-19,20	(Apr-81)	3-0360-123,124	(Apr-81)
1-0130-39,40	(Apr-81)	3-0360-21,22	(Apr-81)	3-0360-125,126	(Apr-81)
1-0130-41,42	(Apr-81)	3-0360-23,24	(Apr-81)	3-0360-127,128	(Apr-81)
1-0130-43,44	(Apr-81)	3-0360-25,26	(Apr-81)	3-0360-129,130	(Apr-81)
1-0130-45,46	(Apr-81)	3-0360-27,28	(Apr-81)	3-0360-131,132	(Apr-81)
1-0130-47,48	(Apr-81)	3-0360-29,30	(Apr-81)	3-0360-133,134	(Apr-81)
1-0130-49,50	(Apr-81)	3-0360-31,32	(Apr-81)	3-0370-1,2	(Apr-81)
1-0130-51,52	(Apr-81)	3-0360-33,34	(Apr-81)	3-0370-3,4	(Apr-81)
1-0130-53,54	(Apr-81)	3-0360-35,36	(Apr-81)	3-0370-5,6	(Apr-81)
1-0130-55,56	(Apr-81)	3-0360-37,38	(Apr-81)	3-0399-1,2	(Apr-81)
1-0130-57,58	(Apr-81)	3-0360-39,40	(Apr-81)	3-0399-3,4	(Apr-81)
1-0130-59,60	(Apr-81)	3-0360-41,42	(Apr-81)	3-0399-5,6	(Apr-81)
1-0130-61,62	(Apr-81)	3-0360-43,44	(Apr-81)		
1-0130-63,64	(Apr-81)	3-0360-45,46	(Apr-81)	4-0400-1,2	(Apr-81)
1-0130-65,66	(Apr-81)	3-0360-47,48	(Apr-81)	4-0400-3,4	(Apr-81)
1-0130-67,68	(Apr-81)	3-0360-49,50	(Apr-81)	4-0401-1,2	(Apr-81)
1-0199-1,2	(Apr-81)	3-0360-51,52	(Apr-81)	4-0401-3,4	(Apr-81)
1-0199-3,4	(Apr-81)	3-0360-53,54	(Apr-81)	4-0401-5,6	(Apr-81)
1-0199-5,6	(Apr-81)	3-0360-55,56	(Apr-81)	4-0402-1,2	(Apr-81)
1-0199-7,8	(Apr-81)	3-0360-57,58	(Apr-81)	4-0402-3,4	(Apr-81)
1-0199-9,10	(Apr-81)	3-0360-59,60	(Apr-81)	4-0402-5,6	(Apr-81)
1-0199-11,12	(Apr-81)	3-0360-61,62	(Apr-81)	4-0403-1,2	(Apr-81)

**COMPLETE PAGE LISTING  
WITH LATEST DATELINES**

4-0403-3,4	(Apr-81)	5-0505-1,2	(Apr-81)	16-1675-1,2	(Apr-81)
4-0404-1,2	(Apr-81)	5-0505-3,4	(Apr-81)	16-1676-1,2	(Apr-81)
4-0407-1,2	(Apr-81)	5-0505-5,6	(Apr-81)	16-1676-3,4	(Apr-81)
4-0407-3,4	(Apr-81)	5-0510-1,2	(Apr-81)	16-1676-5,6	(Apr-81)
4-0408-1,2	(Apr-81)	5-0510-3,4	(Apr-81)	16-1699-1,2	(Apr-81)
4-0409-1,2	(Apr-81)	5-0515-1,2	(Apr-81)	16-1699-3,4	(Apr-81)
4-0409-3,4	(Apr-81)	5-0515-3,4	(Apr-81)	16-1699-5,6	(Apr-81)
4-0409-5,6	(Apr-81)	5-0515-5,6	(Apr-81)	16-1699-7,8	(Apr-81)
4-0410-1,2	(Apr-81)	5-0520-1,2	(Apr-81)	17-1740-1,2	(Apr-81)
4-0413-1,2	(Apr-81)	5-0530-1,2	(Apr-81)	17-1740-3,4	(Apr-81)
4-0413-3,4	(Apr-81)	5-0540-1,2	(Apr-81)	17-1746-1,2	(Apr-81)
4-0413-5,6	(Apr-81)	5-0560-1,2	(Apr-81)	17-1749-1,2	(Apr-81)
4-0416-1,2	(Apr-81)	5-0560-3,4	(Apr-81)	18-1810-1,2	(Apr-81)
4-0416-3,4	(Apr-81)	5-0599-1,2	(Apr-81)	18-1810-3,4	(Apr-81)
4-0416-5,6	(Apr-81)	8-0841-1,2	(Apr-81)	18-1810-5,6	(Apr-81)
4-0416-7,8	(Apr-81)	8-0841-3,4	(Apr-81)	18-1810-7,8	(Apr-81)
4-0417-1,2	(Apr-81)	8-0851-1,2	(Apr-81)	18-1810-9,10	(Apr-81)
4-0417-3,4	(Apr-81)	8-0851-3,4	(Apr-81)	18-1821-1,2	(Apr-81)
4-0417-5,6	(Apr-81)	8-0851-5,6	(Apr-81)	18-1821-3,4	(Apr-81)
4-0417-7,8	(Apr-81)	8-0851-7,8	(Apr-81)	18-1821-5,6	(Apr-81)
4-0417-9,10	(Apr-81)	8-0899-1,2	(Apr-81)	18-1821-7,8	(Apr-81)
4-0418-1,2	(Apr-81)	11-1111-1,2	(Apr-81)	18-1830-1,2	(Apr-81)
4-0419-1,2	(Apr-81)	11-1111-3,4	(Apr-81)	18-1830-3,4	(Apr-81)
4-0420-1,2	(Apr-81)	11-1111-5,6	(Apr-81)	18-1830-5,6	(Apr-81)
4-0421-1,2	(Apr-81)	11-1115-1,2	(Apr-81)	18-1830-7,8	(Apr-81)
4-0422-1,2	(Apr-81)	11-1115-3,4	(Apr-81)	18-1830-9,10	(Apr-81)
4-0422-3,4	(Apr-81)	11-1160-1,2	(Apr-81)	18-1830-11,12	(Apr-81)
4-0422-5,6	(Apr-81)	11-1160-3,4	(Apr-81)	18-1830-13,14	(Apr-81)
4-0422-7,8	(Apr-81)	11-1199-1,2	(Apr-81)	18-1830-15,16	(Apr-81)
4-0422-9,10	(Apr-81)	15-1511-1,2	(Apr-81)	18-1830-17,18	(Apr-81)
4-0429-1,2	(Apr-81)	15-1511-3,4	(Apr-81)	18-1830-19,20	(Apr-81)
4-0433-1,2	(Apr-81)	15-1512-1,2	(Apr-81)	18-1030-21,22	(Apr-81)
4-0499-1,2	(Apr-81)	16-1671-1,2	(Apr-81)	18-1830-23,24	(Apr-81)
4-0499-3,4	(Apr-81)	16-1671-3,4	(Apr-81)	18-1830-25,26	(Apr-81)
4-0499-5,6	(Apr-81)	16-1671-5,6	(Apr-81)	18-1830-27,28	(Apr-81)
4-0499-7,8	(Apr-81)	16-1671-7,8	(Apr-81)	18-1830-29,30	(Apr-81)
4-0499-9,10	(Apr-81)	16-1671-9,10	(Apr-81)	18-1830-31,32	(Apr-81)
4-0499-11,12	(Apr-81)	16-1672-1,2	(Apr-81)	18-1899-1,2	(Apr-81)
4-0499-13,14	(Apr-81)	16-1672-3,4	(Apr-81)	18-1899-3,4	(Apr-81)
4-0499-15,16	(Apr-81)	16-1672-5,6	(Apr-81)	19-1910-1,2	(Apr-81)
4-0499-17,18	(Apr-81)	16-1672-7,8	(Apr-81)	19-1910-3,4	(Apr-81)
4-0499-19,20	(Apr-81)	16-1672-9,10	(Apr-81)	19-1910-5,6	(Apr-81)
4-0499-21,22	(Apr-81)	16-1672-11,12	(Apr-81)	19-1921-1,2	(Apr-81)
4-0499-23,24	(Apr-81)	16-1672-13,14	(Apr-81)	20-2003-1,2	(Apr-81)
4-0499-25,26	(Apr-81)	16-1672-15,16	(Apr-81)	20-2003-3,4	(Apr-81)
4-0499-27,28	(Apr-81)	16-1672-17,18	(Apr-81)	20-2004-1,2	(Apr-81)
4-0499-29,30	(Apr-81)	16-1672-19,20	(Apr-81)	20-2006-1,2	(Apr-81)
4-0499-31,32	(Apr-81)	16-1672-21,22	(Apr-81)	31-3102-1,2	(Apr-81)
4-0499-33,34	(Apr-81)	16-1672-23,24	(Apr-81)	31-3102-3,4	(Apr-81)
4-0499-35,36	(Apr-81)	16-1673-1,2	(Apr-81)	31-3102-5,6	(Apr-81)
4-0499-37,38	(Apr-81)	16-1674-1,2	(Apr-81)		
4-0499-39,40	(Apr-81)	16-1674-3,4	(Apr-81)		

### COMPLETE PAGE LISTING WITH LATEST DATELINES

31-3115-1,2	(Apr-81)	90-9025-1,2	(Apr-81)	90-9026-67,68	(Apr-81)
31-3140-1,2	(Apr-81)	90-9025-3,4	(Apr-81)	90-9026-69,70	(Apr-81)
31-3160-1,2	(Apr-81)	90-9025-5,6	(Apr-81)	90-9026-71,72	(Apr-81)
31-3160-3,4	(Apr-81)	90-9025-7,8	(Apr-81)	90-9026-73,74	(Apr-81)
31-3160-5,6	(Apr-81)	90-9025-9,10	(Apr-81)	90-9026-75,76	(Apr-81)
31-3160-7,8	(Apr-81)	90-9025-11,12	(Apr-81)	90-9026-77,78	(Apr-81)
31-3160-9,10	(Apr-81)	90-9025-13,14	(Apr-81)	90-9026-79,80	(Apr-81)
31-3160-11,12	(Apr-81)	90-9025-15,16	(Apr-81)	90-9026-81,82	(Apr-81)
31-3160-13,14	(Apr-81)	90-9025-17,18	(Apr-81)	90-9026-83,84	(Apr-81)
31-3160-15,16	(Apr-81)	90-9025-19,20	(Apr-81)	90-9026-85,86	(Apr-81)
31-3160-17,18	(Apr-81)	90-9025-21,22	(Apr-81)	90-9026-87,88	(Apr-81)
31-3160-19,20	(Apr-81)	90-9025-23,24	(Apr-81)	90-9026-89,90	(Apr-81)
31-3160-21,22	(Apr-81)	90-9025-25,26	(Apr-81)	90-9026-91,92	(Apr-81)
31-3199-1,2	(Apr-81)	90-9025A-1,2	(Apr-81)	90-9026-93,94	(Apr-81)
31-3199-3,4	(Apr-81)	90-9025A-3,4	(Apr-81)	90-9026-95,96	(Apr-81)
31-3199-5,6	(Apr-81)	90-9025A-5,6	(Apr-81)	90-9026-97,98	(Apr-81)
		90-9025A-7,8	(Apr-81)	90-9026-99,100	(Apr-81)
42-4201-1,2	(Apr-81)	90-9025A-9,10	(Apr-81)	90-9026-101,102	(Apr-81)
42-4201-3,4	(Apr-81)	90-9025A-11,12	(Apr-81)	90-9026-103,104	(Apr-81)
42-4215-1,2	(Apr-81)	90-9026-1,2	(Apr-81)	90-9026-105,106	(Apr-81)
42-4260-1,2	(Apr-81)	90-9026-3,4	(Apr-81)	90-9026-107,108	(Apr-81)
		90-9026-5,6	(Apr-81)	90-9026-109,110	(Apr-81)
90-9005-1,2	(Apr-81)	90-9026-7,8	(Apr-81)	90-9026-111,112	(Apr-81)
90-9005-3,4	(Apr-81)	90-9026-9,10	(Apr-81)	90-9026-113,114	(Apr-81)
90-9010-1,2	(Apr-81)	90-9026-11,12	(Apr-81)	90-9026-115,116	(Apr-81)
90-9010-3,4	(Apr-81)	90-9026-13,14	(Apr-81)	90-9026-117,118	(Apr-81)
90-9010-5,6	(Apr-81)	90-9026-15,16	(Apr-81)	90-9026-119,120	(Apr-81)
90-9010-7,8	(Apr-81)	90-9026-17,18	(Apr-81)	90-9026-121,122	(Apr-81)
90-9010-9,10	(Apr-81)	90-9026-19,20	(Apr-81)	90-9026-123,124	(Apr-81)
90-9010-11,12	(Apr-81)	90-9026-21,22	(Apr-81)	90-9026-125,126	(Apr-81)
90-9010-13,14	(Apr-81)	90-9026-23,24	(Apr-81)	90-9026-127,128	(Apr-81)
90-9010-15,16	(Apr-81)	90-9026-25,26	(Apr-81)	90-9026-129,130	(Apr-81)
90-9015-1,2	(Apr-81)	90-9026-27,28	(Apr-81)	90-9026-131,132	(Apr-81)
90-9015-3,4	(Apr-81)	90-9026-29,30	(Apr-81)	90-9026-133,134	(Apr-81)
90-9015-5,6	(Apr-81)	90-9026-31,32	(Apr-81)	90-9026-135,136	(Apr-81)
90-9015-7,8	(Apr-81)	90-9026-33,34	(Apr-81)	90-9026-137,138	(Apr-81)
90-9015-9,10	(Apr-81)	90-9026-35,36	(Apr-81)	90-9026-139,140	(Apr-81)
90-9015-11,12	(Apr-81)	90-9026-37,38	(Apr-81)	90-9030-1,2	(Apr-81)
90-9015-13,14	(Apr-81)	90-9026-39,40	(Apr-81)	90-9030-3,4	(Apr-81)
90-9015-15,16	(Apr-81)	90-9026-41,42	(Apr-81)	90-9031-1,2	(Apr-81)
90-9015-17,18	(Apr-81)	90-9026-43,44	(Apr-81)	90-9031-3,4	(Apr-81)
90-9015-19,20	(Apr-81)	90-9026-45,46	(Apr-81)	90-9031-5,6	(Apr-81)
90-9015-21,22	(Apr-81)	90-9026-47,48	(Apr-81)	90-9031-7,8	(Apr-81)
90-9015-23,24	(Apr-81)	90-9026-49,50	(Apr-81)	90-9031-9,10	(Apr-81)
90-9015-25,26	(Apr-81)	90-9026-51,52	(Apr-81)	90-9031-11,12	(Apr-81)
90-9015-27,28	(Apr-81)	90-9026-53,54	(Apr-81)	90-9031-13,14	(Apr-81)
90-9015-29,30	(Apr-81)	90-9026-55,56	(Apr-81)	90-9031-15,16	(Apr-81)
90-9015-31-32	(Apr-81)	90-9026-57,58	(Apr-81)	90-9031-17,18	(Apr-81)
90-9020-1,2	(Apr-81)	90-9026-59,60	(Apr-81)	90-9031-19,20	(Apr-81)
90-9020-3,4	(Apr-81)	90-9026-61,62	(Apr-81)	90-9035-1,2	(Apr-81)
90-9020-5,6	(Apr-81)	90-9026-63,64	(Apr-81)	90-9035-3,4	(Apr-81)
90-9020-7,8	(Apr-81)	90-9026-65,66	(Apr-81)	90-9035-5,6	(Apr-81)

90-9035-7,8	(Apr-81)
90-9035-9,10	(Apr-81)
90-9035-11,12	(Apr-81)
90-9035-13,14	(Apr-81)
90-9035-15,16	(Apr-81)
90-9035-17,18	(Apr-81)
90-9035-19,20	(Apr-81)

## Group II INTRODUCTION AND SAFETY INFORMATION

### INTRODUCTION

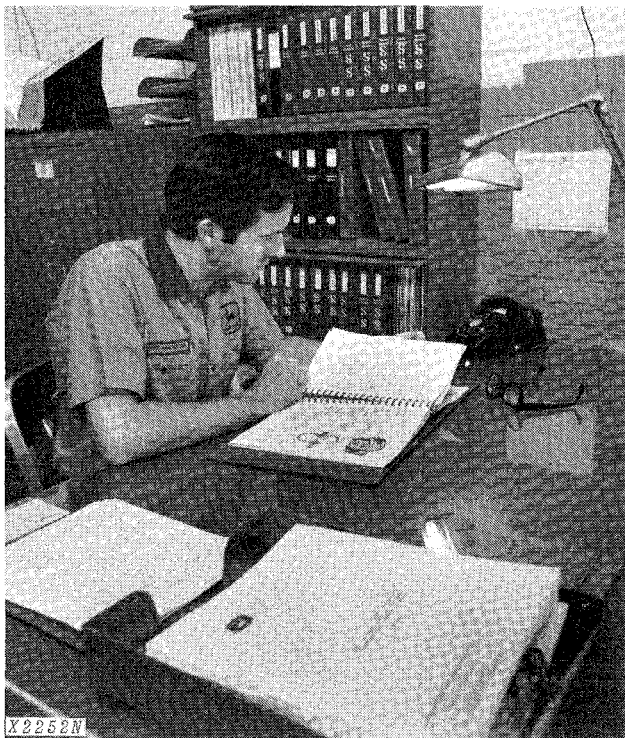

Use FOS Manuals for Reference

This technical manual is part of a twin concept of service:

The two kinds of manuals work as a team to give you both the general background and technical details of shop service.

#### •FOS Manuals—for reference

*Fundamentals of Service (FOS) Manuals* cover basic theory of operation, *fundamentals* of trouble shooting, *general* maintenance, and *basic* types of failures and their causes. FOS Manuals are for training new personnel and for reference by experienced service technicians.



When a service technician should refer to a FOS Manual for more information, a FOS symbol like the one at the left is used in the TM to identify the reference.

#### •Technical Manuals—for actual service

*Technical Manuals* are concise service guides for a *specific* machine. Technical manuals are on-the-job guides containing only the vital information needed by an experienced service technician.



Use Technical Manuals for Actual Service

This technical manual was planned and written for you—an experienced service technician. Keep it in a permanent binder in the shop where it is handy. Refer to it whenever in doubt about correct service procedures or specifications.

Some features of this manual:

- Inside front cover - "Table of Contents".
- Section I - Contents, Introduction and Safety Information, General Specifications, and Lubrication.
- Sections 1 through 42 - Removal repair, testing (components removed), installation, and adjustment.
- Section 90 - Detailed explanation of system operation, diagnosis, visual inspection, testing, and adjustments.
- Specifications grouped and illustrated at the end of each section.

## MAINTENANCE WITHOUT ACCIDENT

### SAFETY AND YOU



T27999N

**⚠ CAUTION:** This safety symbol followed by the word "caution" identifies important safety messages in this manual and on the crawler loader. When you see this symbol, be alert to the possibility of personal injury and carefully read the message that follows.



T73433

T73433

Be prepared if an accident or fire should occur. Know where the first aid kit and the fire extinguishers are located - know how to use them.

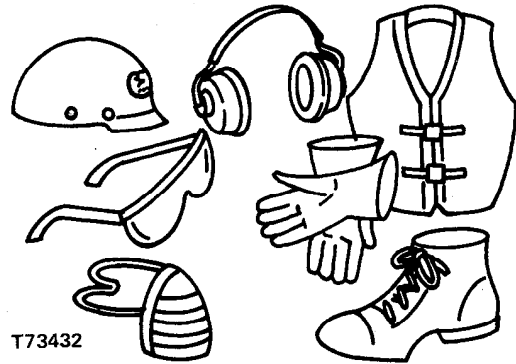

T73432

Wear safety equipment.



T45672

Wear fairly tight clothing.

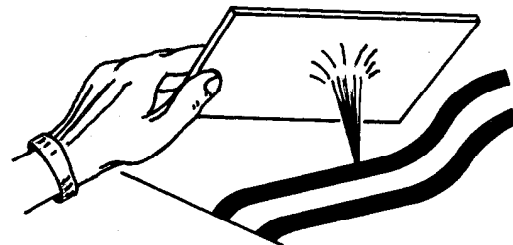

T45794

**⚠ CAUTION:** Escaping fluid under pressure can have sufficient force to penetrate the skin, causing serious injury. Before disconnecting lines, be sure to relieve pressure. Before applying pressure, be sure connections are tight and lines, pipes and hoses are not damaged. Use a piece of cardboard or wood, rather than hands, to search for leaks.

If injured by escaping fluid, see a doctor at once. Serious infection or reaction can develop if proper medical treatment is not administered immediately.

## MAINTENANCE WITHOUT ACCIDENT

### KEEP SHOP AND STORAGE AREA CLEAN

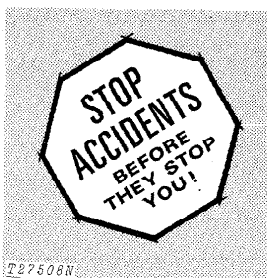

Maintenance area should be adequately vented.

Keep maintenance area clean and dry.

Store flammable materials in a cool and well-vented area out of reach of unauthorized personnel.

### FOLLOW SAFE WORKING CONDITIONS

Perform work on equipment only if authorized to do so.

Follow recommended procedures.

X WRONG

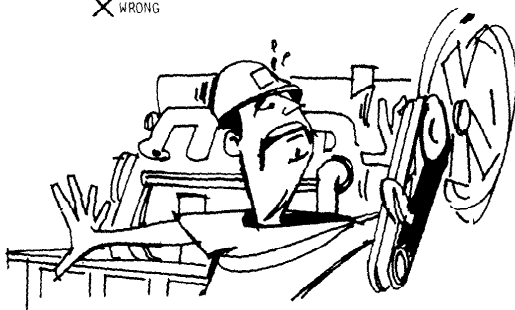

Do not service equipment while it is being operated or engine is running.

Keep hands away from moving parts.

Do not use open flame around machine.

If machine is on an incline, block it securely.

Use hoisting equipment for lifting heavy parts.

Litho in U.S.A.

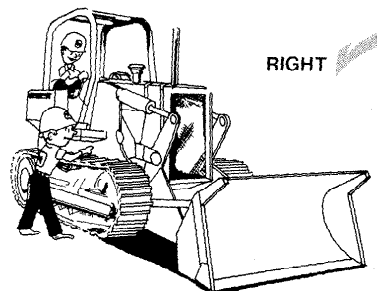

If it is necessary to make checks with the engine running, always use two service technicians - one, the operator at the controls, the other checking within sight of the operator.

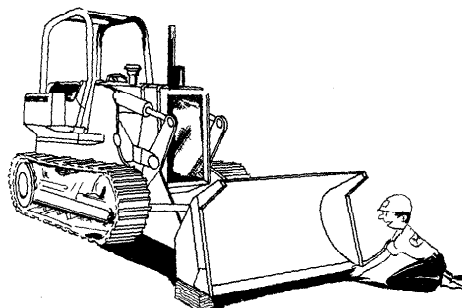

Support all raised equipment.

Do not work under raised bucket.

Always lower bucket before working on it.

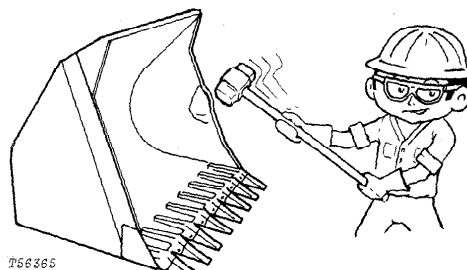

Wear safety glasses when drilling, grinding or hammering metal.

## MAINTENANCE WITHOUT ACCIDENT

### OBSERVE SERVICE PRECAUTIONS

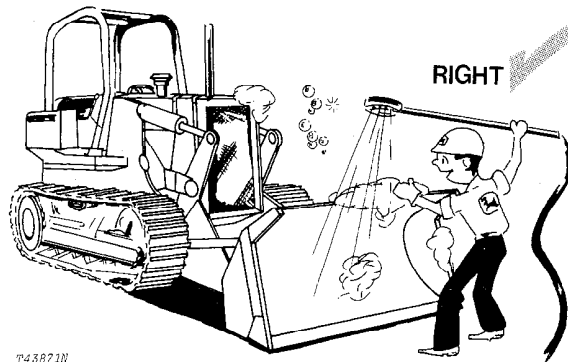

Keep all equipment free of dirt and oil.

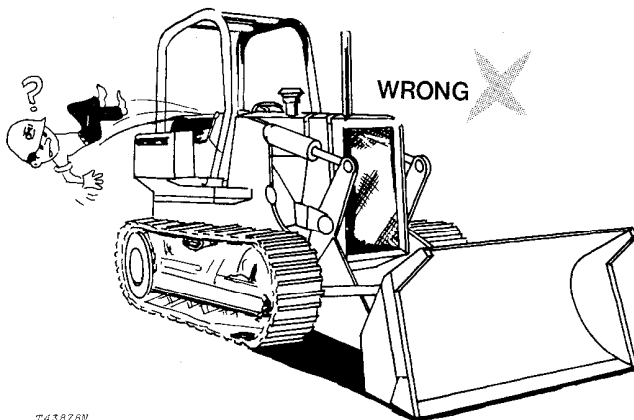

Remove oil, grease, mud, ice, or snow from floor of operator's compartment or steps.

Do not remove radiator filler cap unless engine is cool. Then loosen cap slowly to the stop. Release pressure before you remove cap.

Check exhaust system periodically for excessive leakage.

Relieve hydraulic pressure before working on hydraulic system.

Use the correct test group when checking hydraulic pressure.

Discharge accumulators completely before recharging or servicing.

### OBSERVE REPAIR PRECAUTIONS

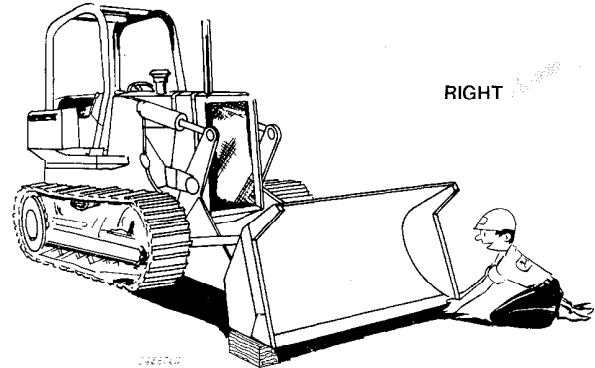

Securely block bucket before changing cutting edges. Wear gloves when working with sharp edges.

Relieve hydraulic pressure before working on hydraulic system.

Turn off battery disconnect switch before repairing the electrical system or performing a major overhaul.

Install lift arm locking pin before working in engine area.

### CHECK SAFETY EQUIPMENT ON MACHINE

Check that all protective devices (guards, canopies, shields, ROPS, seat belts, etc.) are installed and secured on machine.

Inspect machine carefully for leakage from lines, hoses, and fittings.

## MAINTENANCE WITHOUT ACCIDENT

### AVOID EXPLOSIONS OR FIRE

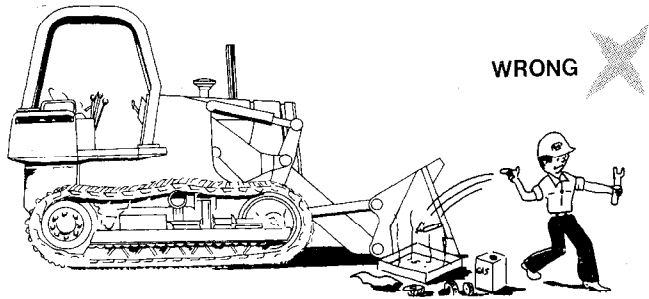

T43866N

Do not smoke while refueling.

Do not smoke while handling highly flammable materials.

Shut off engine when refueling.

Use care in refueling if engine is hot.

Use good commercial, nonflammable solvents for cleaning parts.

Although it is impractical to try to cover every possible maintenance situation, the safety precautions recommended here should serve to develop and promote safe maintenance procedures.

The information contained in this manual is not intended to replace safety codes, insurance requirements, federal, state, and local laws, rules and regulations. In particular, your service area or jobsite activities may be subject to state safety rules and/or federal regulation under the Occupational Safety and Health Act (OSHA). Familiarize yourself with all regulations applicable to your situation in order to avoid possible safety violations.

### OBSERVE BATTERY PRECAUTIONS



T27506N

Do not place metal objects across posts to check charge.

Do not smoke near battery.

Do not allow sparks or open flame near battery.

Provide adequate ventilation when charging batteries.



## Group III General Specifications

(Specifications and design subject to change without notice. Wherever applicable, specifications are in accordance with ICED and SAE Standards. Except where otherwise noted, these specifications are based on a unit equipped with 2 cu. yd. (1.53 m<sup>3</sup>) bucket with teeth, roll-over protective canopy, four counterweights, and standard equipment.)

Power (@ 2100 rpm):	SAE	DIN
Gross .....	122 hp (91 kW)	
Net .....	110 hp (97 kW)	111.5 PS

Net engine flywheel power is for an engine equipped with fan, air cleaner, water pump, lubricating oil pump, fuel pump, alternator, and muffler. The gross engine power is without fan. Flywheel power ratings are under SAE standard conditions of 500-ft. altitude and 85°F. temperature, and DIN 6270 conditions (non-corrected). No derating is required up to 10,000 feet (3000 m) altitude.

**Engine:** John Deere 6-cylinder turbocharged diesel, valve-in-head, 4-stroke cycle.

Bore and stroke .... 4.19 × 5 in. (106.4 × 127 mm)  
 Piston displacement ..... 414 cu. in. (6.785 L)  
 Compression ratio ..... 16.2 to 1  
 Maximum torque @ 1300 rpm .. 345 lb-ft (468 N·m)  
 (47.7 kg-m)

NACC or AMA (U.S. Tax) horsepower ..... 42  
 Lubrication ..... Pressure system with full flow filters  
 Main bearings ..... 7  
 Cooling ..... Pressurized with thermostat and controlled bypass  
 Fan ..... Blower  
 Dual-stage aspirated air cleaner  
 with restriction indicator ..... Dry  
 Electrical system ..... 24 volt with alternator  
 Batteries (two 12-volt) ..... Reserve capacity:  
 180 minutes each

### Transmission:

Cold weather starting ..... Disconnect clutch completely disengages hydrostatic drive and all hydraulics.  
 Splitter drive ..... Pressure-lubricated helical gears drive both hydrostatic transmissions, main hydraulic pump, winch drive shaft and auxiliary pump drive.  
 Drive .... Dual-Path, fully automatic, infinitely variable hydrostatic transmissions.  
 Speeds ..... Infinite from 0 to 6.5 mph (0 to 10.5 km/h) forward or reverse.  
 Control ..... Single-lever, variable speed, forward and reverse.

### Steering:

Fully modulated, infinitely variable pedal steering for live power turns and counterrotation. No need for steering clutches or steering brakes.

### Brakes:

Service ..... Hydrostatic  
 Parking ... Wet-disk brakes are automatically applied when engine is stopped, or manually applied with center foot pedal during normal operation.

### Hydraulic System: Open-center

Control ..... Single-lever bucket control with automatic bucket positioner and float position. Three-function valve.  
 Pump ..... Vane, 55 gpm (3.47 L/s) @ rated engine speed  
 Pressure ..... 2500 psi (15 514 kPa) (158.2 kg/cm<sup>2</sup>)  
 Oil lines ..... Seamless steel tubing; double-wire-braid hose  
 Filter ..... 10 micron filter in return line w/bypass

### Hydraulic Cylinders: Bore Stroke

Boom (2) ..... 5.50 in. (140 mm) 32 in. (813 mm)  
 Bucket (2) ..... 4.50 in. (114 mm) 21.52 in. (547 mm)  
 Cylinder rods .. Ground, heat-treated, chrome-plated, polished  
 Boom cylinder rods ..... 3.75 in. (95 mm) dia.  
 Bucket cylinder rods ..... 2.25 in. (57 mm) dia.

### Tracks (6-roller track frame with front and rear track guides and sprocket guard):

Two bar grouser ..... 15 in. (381 mm)  
 Track shoes, each side ..... 40  
 Ground contact area ..... 2724 sq. in. (17 575 cm<sup>2</sup>)  
 Ground pressure .. 11.8 psi (81.4 kPa) (0.830 kg/cm<sup>2</sup>)  
 Length of track on ground ..... 90.8 in. (2.31 m)  
 Track gauge ..... 64 in. (1.63 m)  
 Carrier roller ..... 1 each side  
 Adjustment ..... Hydraulic  
 Minimum ground clearance ..... 15.3 in. (389 mm)

**SAE Operating Weight w/ROPS** ..... 32,005 lb.  
(14 517 kg)

<b>Capacities:</b>	<b>U.S.</b>	<b>Imp.</b>	<b>Liters</b>
Cooling system .....	7 gal.	5.8 gal.	26.5
Fuel tank .....	73 gal.	60.8 gal.	276.3
Crankcase .....	18 qt.	15.0 qt.	17.0
Crankcase, including filter .....	20 qt.	16.7 qt.	18.9
Splitter drive .....	1.5 gal.	1.3 gal.	5.7
Final drive each: 1st reduction .....	5.375 gal.	4.5 gal.	20.3
2nd reduction .....	3.5 gal.	2.9 gal.	13.2
Loader hydraulic system .....	37 gal.	30.8 gal.	140.1
Hydrostatic drives .....	33 gal.	27.5 gal.	124.9

**Additional Standard Equipment:**

Enclosed alternator with solid-state regulator  
Bottom guards  
Suspension seat with armrests  
Key switch  
Pushbutton starting  
Electric hour meter  
Cigar lighter  
Vandal protection  
Boom safety lock pin  
Muffler  
Cold weather starting aid  
Front idler shields  
Master electrical disconnect switch  
Toolbox  
Transmission neutral lock with starter safety switch  
Horn  
Air cleaner restriction indicator  
ROPS canopy with seat belt  
Radiator sand shield

**Special Equipment:**

Oil sampling test kit  
Bucket teeth, bolt-on or flush-mount weld-on  
Hydraulics for rear-mounted equipment  
Hydraulics for front-mounted equipment  
Selector valve for ripper and multipurpose bucket  
Protection package:  
    Limb risers for ROPS canopy  
    Brush screens for operator's compartment  
    Rear bumper  
    Tank guards  
Fire extinguisher  
Front pull hook  
Cab with windshield wipers, pressurizer and heater  
Air conditioner  
Windshield washer  
Engine coolant heater  
Backup alarm  
Lexan® windshield with wiper  
Lexan® windows for cab  
Rock guard, center section

## LOADER DIMENSIONS

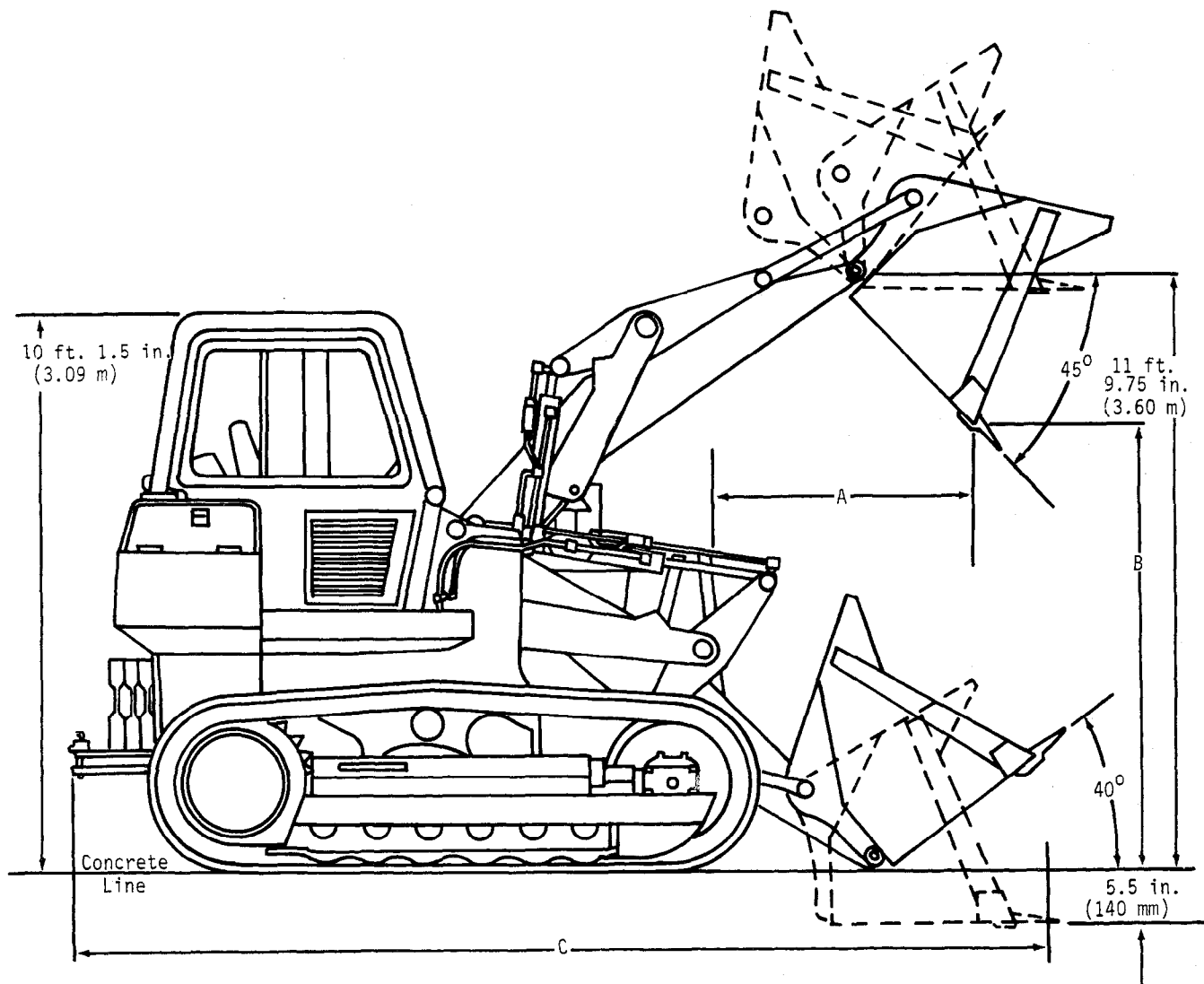

BUCKET CAPACITIES	DIMENSIONS		
	A	B	C
2 cu. yd. bucket (1.68 m <sup>3</sup> )	47.5 in. (1207 mm)	9 ft. 3 in. (2.82 m)	18 ft. 3 in. (5.56 m)
1-3/4 cu. yd. (1.34 m <sup>3</sup> ) multipurpose	53 in. (1.35 m)	9 ft. 4.5 in. (2.86 m)	18 ft. 6.75 in. (5.66 m)

T79498

## LOADER OPERATING DIMENSIONS

OPERATING INFORMATION	BUCKET	
	General Purpose	Multipurpose
Capacity, heaped, SAE	2 cu. yd. (1.53 m <sup>3</sup> )	1-3/4 cu. yd. (1.34 m <sup>3</sup> )
Capacity, struck, SAE	1.67 cu. yd. (1.28 m <sup>3</sup> )	1.38 cu. yd. (1.06 m <sup>3</sup> )
Bucket width	82.5 in. (2.1 m)	83.84 in. (2.13 m)
Bucket weight	1550 lb. (703 kg)	2485 lb. (1127 kg)
SAE breakout force	25,310 lb. (113 kN) (11 480 kg)	23,060 lb. (103 kN) (10 460 kg)
SAE tipping load (w/drawbar and four counterweights)	19,500 lb. (8845 kg)	18,565 lb. (8421 kg)
Raising time	5.86 sec.	5.86 sec.
Dumping time	1.27 sec.	1.27 sec.
Lowering time	3.23 sec.	3.23 sec.
SAE operating weight w/ROPS canopy	32,005 lb. (14 517 kg)	32,940 lb. (14 941 kg)

Adjustments to operating weights and tipping loads:		
Add (+) or deduct (-) lb. (kg) as indicated for loader equipped with:	Loader Operating Weight	Tipping Load
Cab	+740 lb. (336 kg)	+814 lb. (369 kg)
Bucket teeth	-151 lb. (68 kg)	-198 lb. (90 kg)
Air conditioning	+65 lb. (29 kg)	0
Ripper	+2400 lb. (1089 kg)	+4516 lb. (2048 kg)
Multipurpose bucket	+935 lb. (424 kg)	-935 lb. (424 kg)
Counterweight (each)	+ or -500 lb. (227 kg)	+ or -865 lb. (392 kg)

# Group IV LUBRICATION

## GENERAL INFORMATION

Below is a copy of the periodic service chart which is on the outside of the left console (without cab) or outside the left side of the cab. More detailed information for working on the crawler loader is in the current 655 operator's manual.

Use the operator's manual and the periodic service chart as references when working on the crawler loader. Tell your customer to thoroughly read the operator's manual before operating or working on the crawler loader.

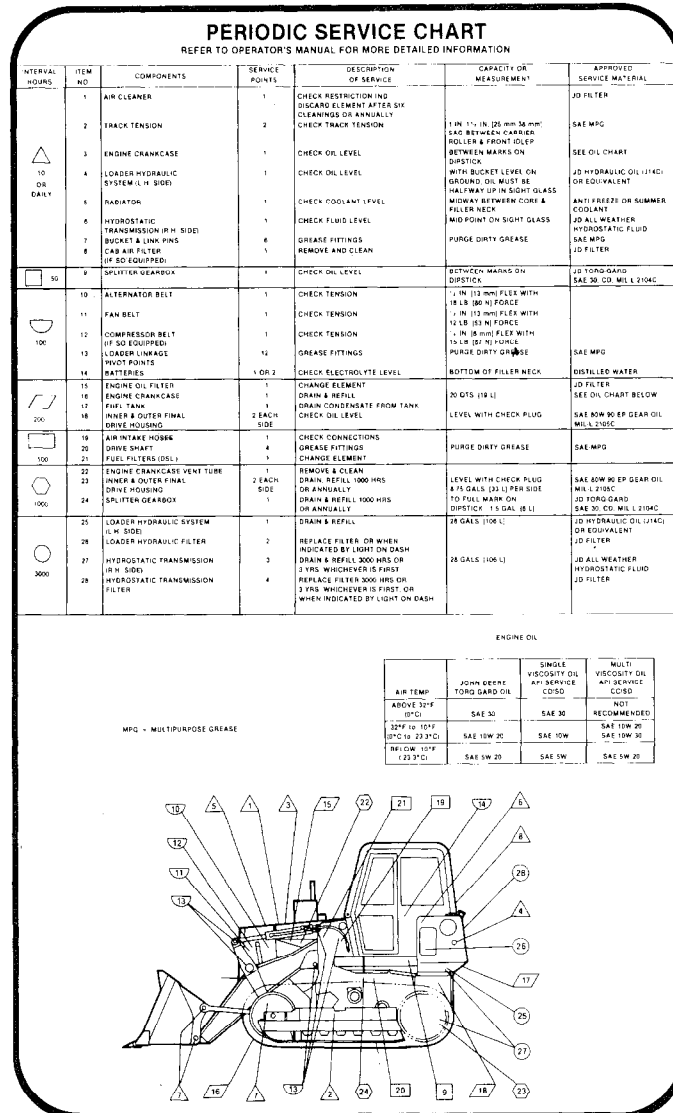

T79497

T79497

Fig. 1-Periodic Service Chart

## LUBRICANTS

### Engine Oils

Use John Deere TORQ-GARD SUPREME® engine oil.

Use John Deere TORQ-GARD SUPREME SAE 10W-20 oil or equivalent during the first 100 hours of operation for break-in.

Oils other than John Deere TORQ-GARD SUPREME must have one of the following specifications:

Single Viscosity Oils	Multi-Viscosity Oils
API Service CD/SC	API Service CC/SE
MIL-L-2104C	MIL-L-46152
Series 3	

### Oils and Air Temperature

Air Temperature	John Deere TORQ-GARD SUPREME Oil	Other Oils	
		Single Viscosity Oil	Multi-Viscosity Oil
Above 32°F (0°C)	SAE 30	SAE 30	Not recommended.
-10°F to 32°F (-23°C) to 0°C)	SAE 10W-20	SAE 10W	SAE 10W-30
Below -10°F (-23°C)	SAE 5W-20	SAE 5W	SAE 5W-20

If you use SAE 5W-20 or SAE 5W oil, your engine may use more oil. Check the oil level regularly.

### Hydrostatic Transmission

Use John Deere All-Weather Hydrostatic Fluid.

### Hydraulic System

Use John Deere Hydraulic Oil (J14C) or an equivalent.

### Inner and Outer Final Drives

Use a Multi-Purpose SAE 80W-90 GL-5 Gear Oil meeting MIL-L-2105C specifications or an equivalent.

### Splitter Drives

Use John Deere TORQ-GARD SUPREME SAE 30W, CD, Engine Oil meeting MIL-L-2104C specifications or equivalent.

### Greases

Use John Deere Multi-Purpose Grease or an equivalent for all grease fittings.

### Storing and Handling Lubricants

Store lubricants in clean containers in an area protected from dust, moisture, and other contamination.

When handling lubricants, use clean containers.

# Section 1 TRACKS

## CONTENTS OF THIS SECTION

	Page		Page
GROUP 0130 - TRACK SYSTEMS		GROUP 0130 - TRACK SYSTEMS (Continued)	
Rock Guards and Track Guides		Front Idler	
General Information .....	0130-3	General Information .....	0130-42
Removal .....	0130-3	Measuring Front Idler Wear .....	0130-42
Repair .....	0130-3	Removal .....	0130-43
Installation .....	0130-3	Repair .....	0130-44
Carrier Rollers		Disassembly .....	0130-44
General Information .....	0130-4	Assembly .....	0130-49
Measuring Carrier Roller Wear .....	0130-4	Installation .....	0130-56
Removal .....	0130-5	Adjustment .....	0130-56
Repair .....	0130-5	Track Adjuster Cylinder	
Disassembly .....	0130-5	General Information .....	0130-57
Assembly .....	0130-9	Removal .....	0130-57
Installation .....	0130-13	Repair .....	0130-57
Track Rollers		Installation .....	0130-58
General Information .....	0130-15	Recoil Spring	
Checking Roller Wear .....	0130-15	General Information .....	0130-59
Removal .....	0130-15	Removal .....	0130-59
Repair .....	0130-27	Repair .....	0130-60
Disassembly .....	0130-16	Installation .....	0130-61
Assembly .....	0130-21	Track Frame	
Installation .....	0130-27	General Information .....	0130-61
Track Shoes		Removal .....	0130-61
General Information .....	0130-29	Repair .....	0130-62
Measuring Grouser Wear .....	0130-29	Track Frame Wear Strips .....	0130-63
Removal .....	0130-29	Installation .....	0130-64
Repair .....	0130-29	Sprocket	
Installation .....	0130-29	General Information .....	0130-65
Track Chain Assembly		Measuring Sprocket Wear .....	0130-65
General Information .....	0130-30	Removal .....	0130-66
Measuring Chain Wear .....	0130-30	Repair .....	0130-66
Removal .....	0130-33	Installation .....	0130-66
Repair .....	0130-35	Leakage Test .....	0130-67
Disassembly .....	0130-35		
Assembly .....	0130-37	GROUP 0199 - SPECIFICATIONS AND	
Use of Shims for Assembly of		SPECIAL TOOLS	
Used Track Components .....	0130-40	Specifications and Torque Values	
Rotating Pins and Bushings .....	0130-40	Track Systems .....	0199-1
Installation .....	0130-40	Special Tools	
		Track Systems .....	0199-6



## Group 0130 TRACK SYSTEMS

### ROCK GUARDS AND TRACK GUIDES

#### GENERAL INFORMATION

Rock guards and track guides help prevent rocks and debris from entering the track system. They also help to keep the tracks centered on the rollers.

#### REMOVAL

Remove cap screws (1, 3, 7 and 9, Fig. 1) and bottom two cap screws from sprocket shield to remove rock guards (5 and 6) and track guides (2 and 10).

#### REPAIR

Inspect rock guards (5 and 6) and track guides (2 and 10) for wear and damage. Repair, weld or replace parts as necessary.

**IMPORTANT: Good welds are important. Have only a qualified welder repair the components. Use E7018 electrodes. Before welding, clean all dirt and paint from the weld areas and turn the battery disconnect switch to "OFF". Connect the welder ground clamp close to each weld area so electrical current does not pass through any bearings.**

#### INSTALLATION

Apply T43513 John Deere LOCTITE® Thread Lock and Sealer (High Strength) or an equivalent to the track guide-to-track frame cap screws (3, 7 and 9, Fig. 1), spacer cap screws (1) and sprocket shield-to-track guide cap screws.

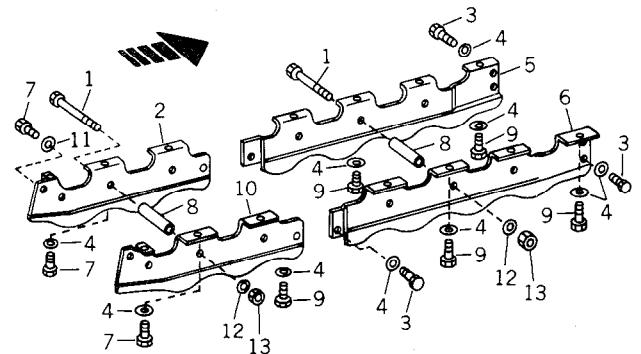

T62207N

T62207N

- |                      |                       |
|----------------------|-----------------------|
| 1—Bolt (6 used)      | 8—Spacer (6 used)     |
| 2—L.H. Track Guide   | 9—Cap Screw (12 used) |
| 3—Cap Screw (6 used) | 10—R.H. Rock Guard    |
| 4—Washer (20 used)   | 11—Washer (2 used)    |
| 5—L.H. Rock Guard    | 12—Washer (6 used)    |
| 6—R.H. Rock Guard    | 13—Nut (6 used)       |
| 7—Cap Screw (4 used) |                       |

Fig. 1—Rock Guards and Track Guides

Install inner rock guard (2, Fig. 1) and inner guide (5) and fasten with cap screws (3, 7 and 9) and washers (4 and 11).

Install cap screws (1) through inner rock guard and track guide, and fasten with washers (12) and nuts (13).

Install outer rock guard (6) and outer track guide (10), and fasten with cap screws (3, 7 and 9) and washers (4).

Install bottom two sprocket shields-to-track guide cap screws, and tighten to (325 N·m) 240 lb-ft.

## CARRIER ROLLERS

### GENERAL INFORMATION

Carrier rollers are used to support and guide the track chain between the drive sprocket and the front idler.

### MEASURING CARRIER ROLLER WEAR

Use a D-05229ST (304.8 mm) 12 in. Spring Caliper (part of D-05227ST Undercarriage Inspection Service Tool Kit) to measure carrier roller diameter.

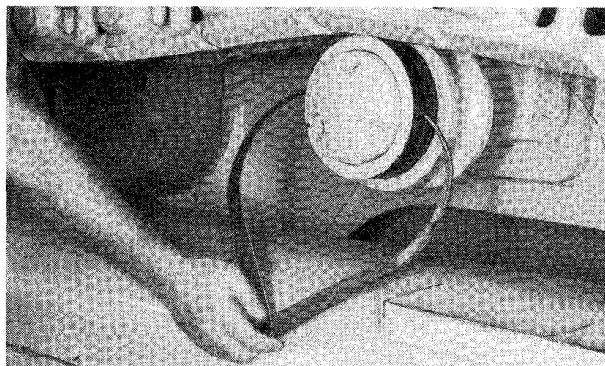

T77883

Fig. 2-Carrier Roller Diameter Measurement

Position a caliper around the carrier roller as shown in Fig. 2. Measure the diameter of the carrier roller running surface. Record the measurement.

The outside diameter of a new carrier roller is (165 mm) 6-1/2 in. Minimum recommended outside diameter of a carrier roller for rebuilding is (148.4 mm) 5.84 in.

*NOTE: For additional information on measuring carrier roller diameter, refer to UNDERCARRIAGE APPRAISAL MANUAL SP-236.*

*NOTE: It is recommended to use previous described procedure for more accurate measurements when replacing the track components. A track wear gauge (JD329-2) is available, enabling the service technician to quickly check the condition of a track assembly.*

Use JD329-2 Track Wear Gauge to measure carrier roller wear as follows:

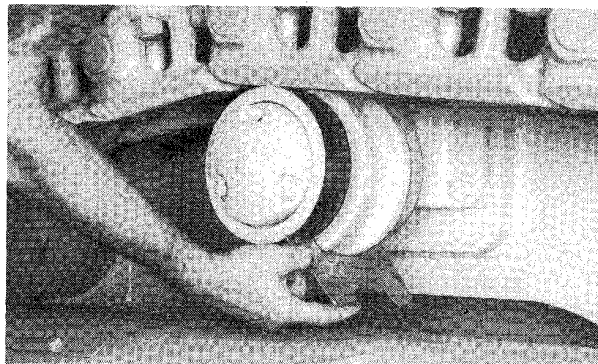

T77884

Fig. 3-Track Carrier Roller Wear

Place the gauge on the carrier roller tight against one flange with the top of the flange even with the line on the gauge. The allowable wear is written on the gauge with an arrow pointing to the location where the gap is to be measured.

## REMOVAL

See page 0130-33 to release tension from track chain.

Raise and support track chain so it is clear of carrier rollers.

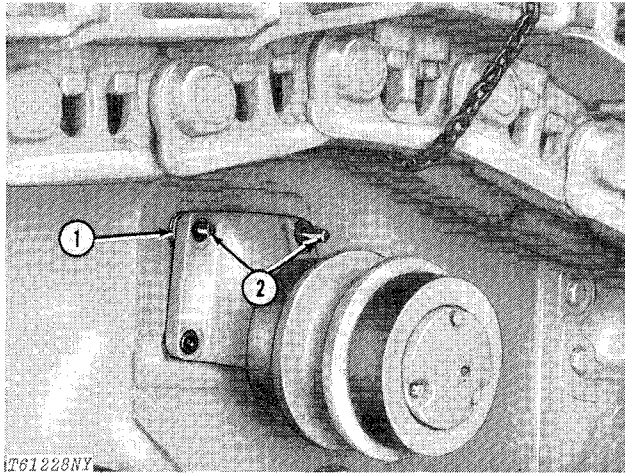

1—Shims

2—Guide Screws

Fig. 4-Removing Carrier Roller

Remove top two cap screws and install two cap screws with the heads cut off to use as guide screws (2, Fig. 4).

Note the number of shims (1) used behind the carrier roller support to aid in installation.

Remove bottom cap screws and shims.

Remove carrier roller.

## REPAIR

### Disassembly

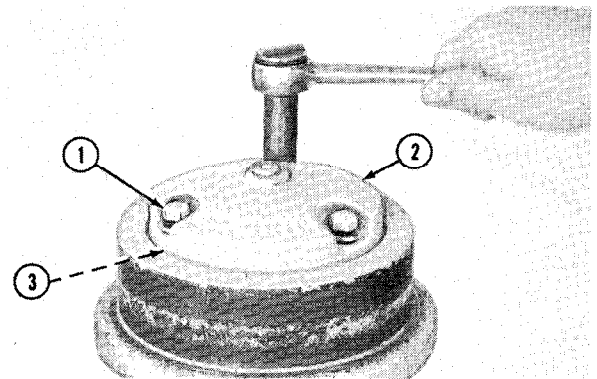

1—Cap Screw (3 used)

2—Cover  
3—Gasket

T80394

Fig. 5-Remove Cover

Remove cap screws (1, Fig. 5) to remove cover (2) and gasket (3).

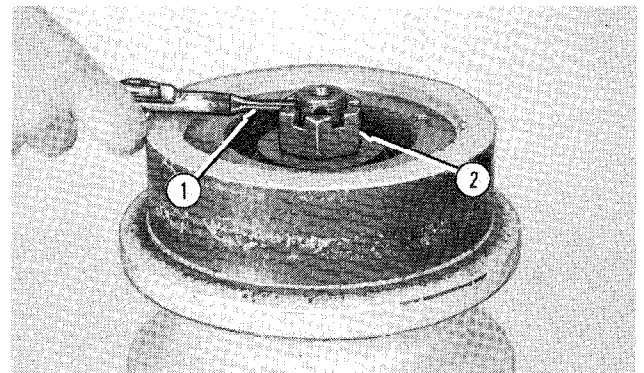

1—Cotter Pin

2—Nut

T80395

Fig. 6-Remove Nut

Remove cotter pin (1, Fig. 6).

Loosen nut (2). Do not remove nut at this time.

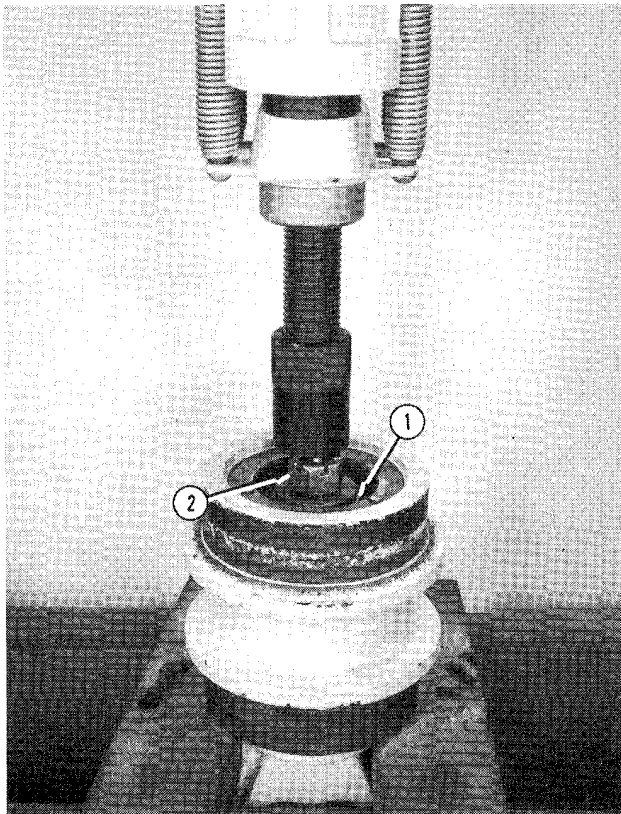

T80396

1—Bearing Cone                      2—Nut

Fig. 7-Remove Bearing Cone

Remove bearing cone (1, Fig. 7) from support bracket using a press.

Remove nut (2).

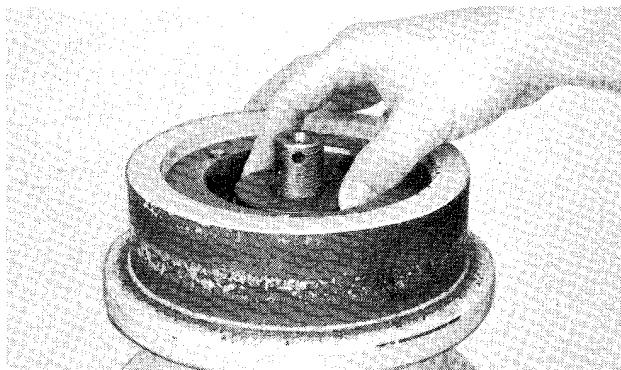

T80397

Fig. 8-Washer

Remove washer (Fig. 8).

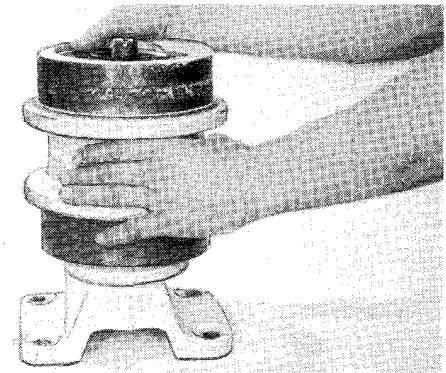

T80398

Fig. 9-Roller Shell

Remove roller shell (Fig. 9).

Inspect the roller shell for grooved, burred or galled condition. Replace parts if necessary.

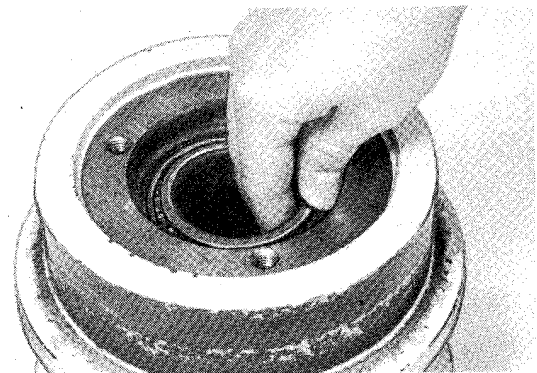

T80400

Fig. 10-Bearing Cone

Remove bearing cone (Fig. 10).

Wash bearing cones thoroughly in volatile mineral spirits.

Before inspection, oil the bearings with the same type of oil that will be used in the carrier roller.

**NOTE:** Never dry bearings with compressed air. Do not rotate bearings while they are not lubricated.

Inspect bearings for roughness of rotation. Replace a bearing if its rotation is still rough after cleaning and oiling.

Inspect bearings for scored, pitted, scratched, cracked or chipped races, and for indication of excessive wear of rollers. If one of these defects is found, replace the bearing.

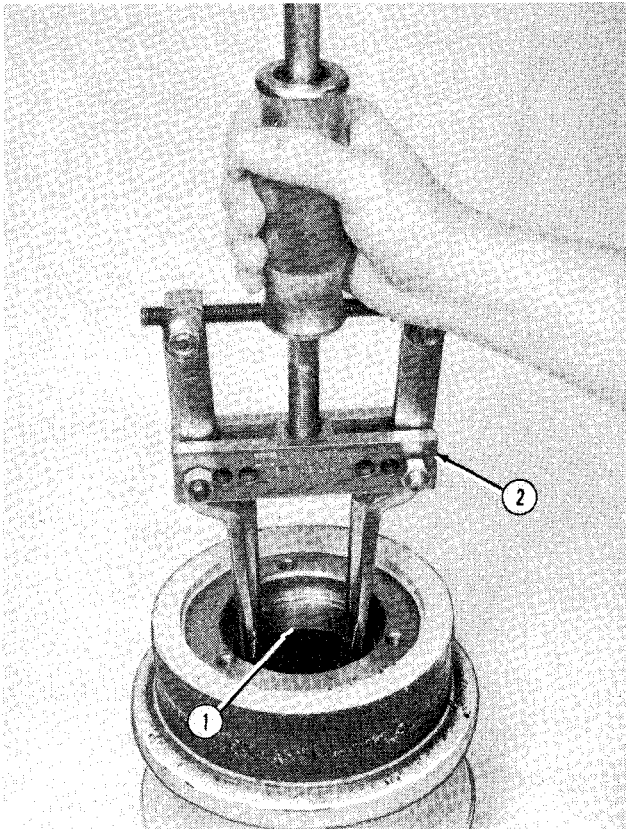

1—Bearing Cups (2 used)      2—Two Jaw Puller

T80401

*Fig. 11-Bearing Cup*

Remove bearing cups (1, Fig. 11) with a two jaw puller (2) from the D-01047AA Puller Set.

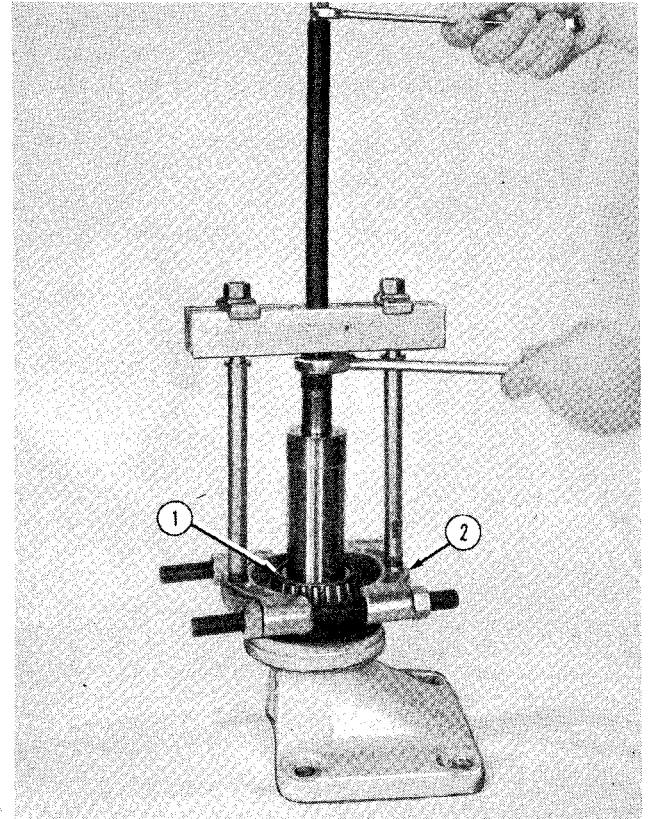

1—Bearing Cone      2—Puller

T80402

*Fig. 12-Bearing Cone*

Remove bearing cone (1, Fig. 12) with a puller (2) from the D-01047AA Puller Set.

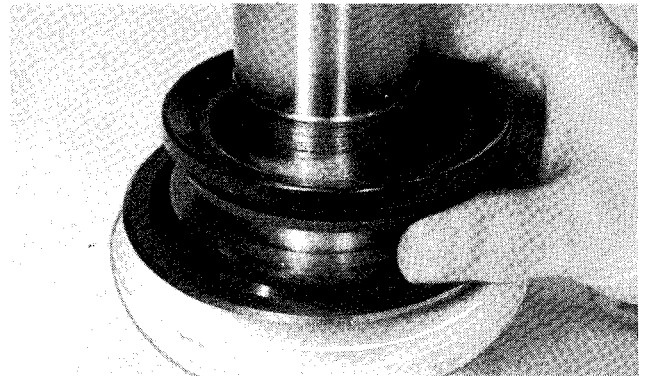

*Fig. 13-Metal Face Seal*

T80403

Remove metal face seals (Fig. 13). Tape the metal face seals together to keep them in matched sets.

After removal of sealing rings, inspect sealing ring pattern to find out if seals can be reused. Refer to the steps and figures below to determine the condition of the metal rings.

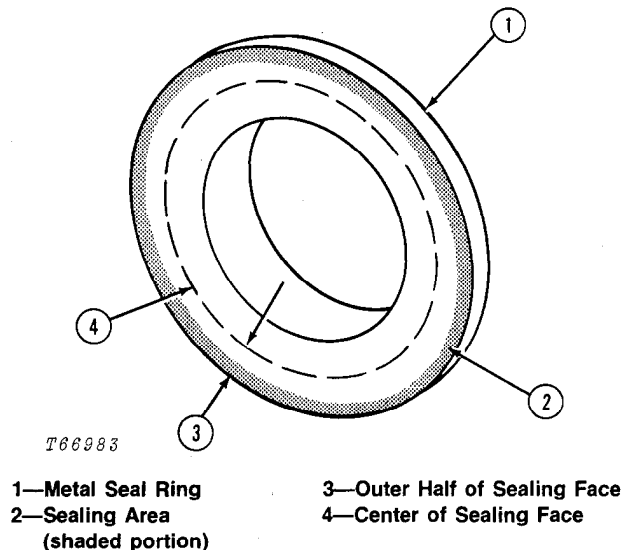

Fig. 14-A Good Sealing Ring

The following three steps are specifications which determine a good sealing ring.

1. The narrow, highly polished sealing area (2, Fig. 14) must be within outer half of the sealing face (3).
2. The sealing area (2) must be uniform and concentric with the I.D. and O.D. of metal seal ring (1).
3. The sealing area must not be chipped or scratched in any way.

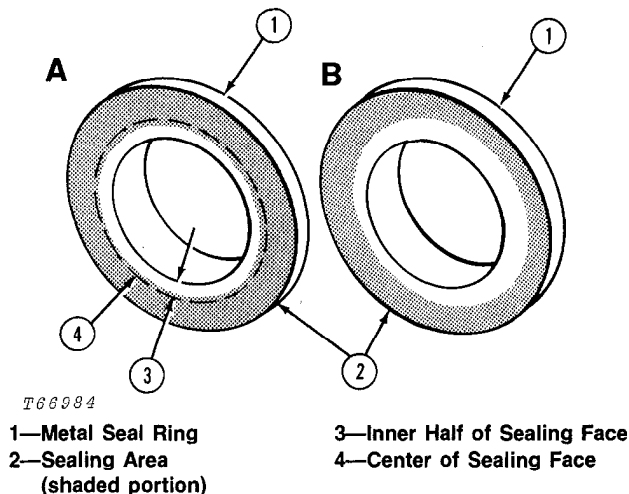

Fig. 15-A Poor Sealing Ring

The two drawings in Fig. 15 show examples of poor metal seal rings.

Drawing A (Fig. 15) shows the sealing area (2) within inner half of sealing face (3).

Drawing B (Fig. 15) shows the sealing area (2) not concentric with I.D. and O.D. of metal seal ring (1).

Clean the metal sealing rings as follows:

Remove any corrosion or hardened material that may exist on the metal ring other than the sealing area. Use a scraper and/or any stiff bristled fiber brush to remove the foreign material from the surface.

Wash the metal sealing rings with a volatile, non-petroleum base type solvent to remove all oil and wipe dry. Use the lint free wiper furnished in the new seal package to remove all traces of oil or grease from all surfaces.

**NOTE:** If metal rings appear to be useable, keep the two metal face seals together as matched sets. If the metal rings are not within proper specifications, DO NOT rebuild the seal, use a completely new seal.

## Assembly

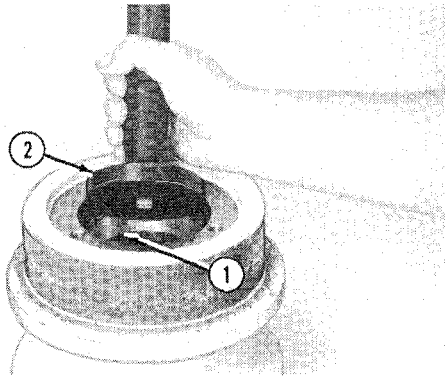

T80404

1—Bearing Cup (2 used)      2—27534 Disk

Fig. 16-Install Bearing Cup

Install bearing cups (1, Fig. 16) to bottom of roller shell bore with a 27534 Disk (2) and a handle from the D-01045AA Driver Set.

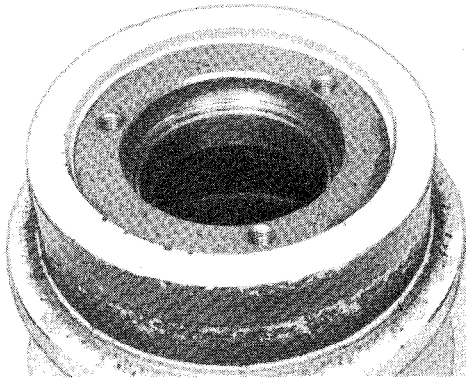

T80405

Fig. 17-Roller Shell Bore

Thoroughly clean the seal cavities in the roller shell (Fig. 17) with a volatile, non-petroleum base-type solvent. Be sure they are dry and oil free.

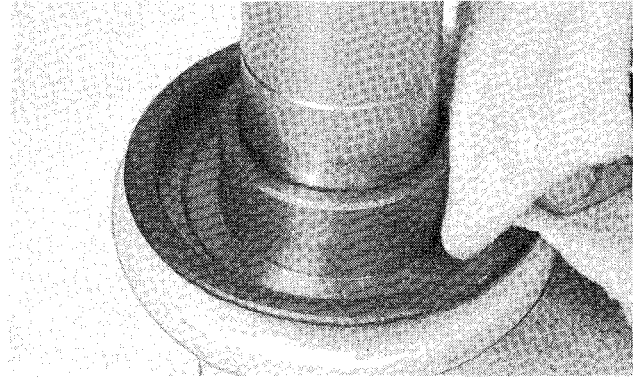

T80406

Fig. 18-Support Bracket

Thoroughly clean the seal cavity in the support bracket (Fig. 18) with a volatile, non-petroleum base-type solvent. Be sure they are dry and oil free.

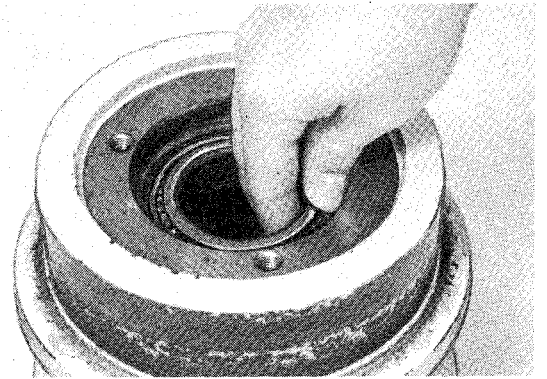

T80400

Fig. 19-Install Bearing Cone

Install bearing cone (Fig. 19). Be sure seal cavity is clean.

*NOTE: Use procedure 1 to install metal face seals when the entire seal is replaced. Use procedure 2 to install metal face seals when the rubber seals are replaced (metal seal rings reused).*

**Procedure 1: New Seal**

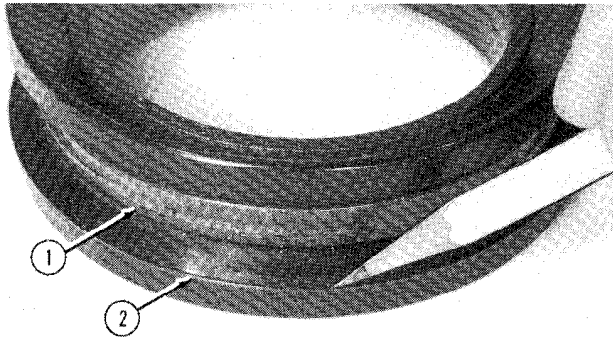

1—Plastic Retainer Band                      2—Retainer Lip

*Fig. 20-Locating Retainer Lip*

DO NOT remove plastic retainer band (1, Fig. 20) from new seal before installation.

Find the side of seal that has a retainer lip (2) on the rubber seals.

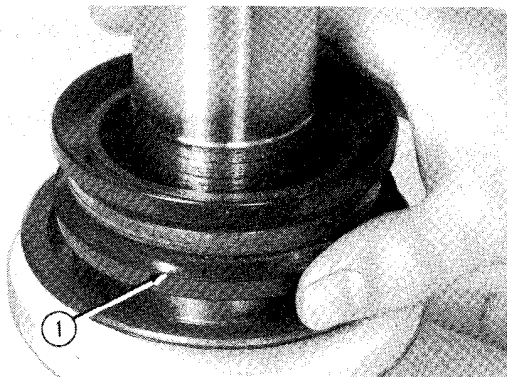

1—Retainer Lip

*Fig. 21-Install Seal*

Install metal face seal, with retainer lip (1, Fig. 21) first, into the seal bore in the support bracket.

Be sure the seal is seated on bottom of bore and sits straight.

**Procedure 2: New Rubber Seals and Used Metal Seal Rings**

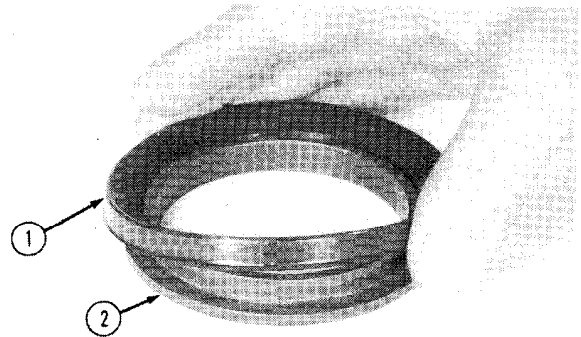

1—Rubber Seal

2—Metal Seal Ring

*Fig. 22-Install Rubber Seal*

Clean metal seal rings (2, Fig. 22) in a volatile non-petroleum base type solvent and wipe dry with lint free cloth.

Install new rubber seals (1) onto the metal seal rings. Be sure the rubber seal is tight and straight against the metal seal ring shoulder flange. Be sure the rubber seals are free of oil.

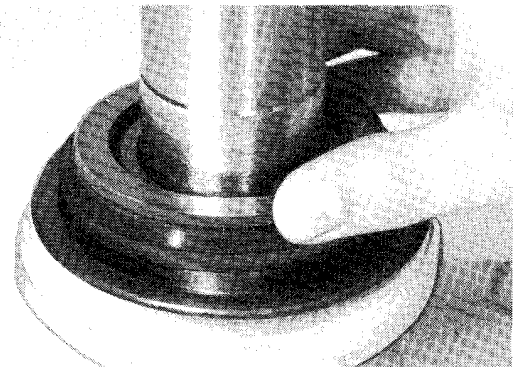
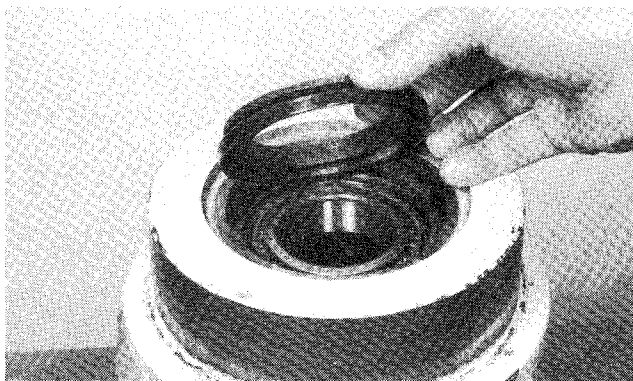

*Fig. 23-Install Seal*

Install metal face seal half, with retainer lip first, into the seal bore in the support bracket (Fig. 23).

Be sure the seal is tight against the seal bore and sits straight.

**IMPORTANT: The new rubber seal must have a retainer lip to hold the seal half in the bore before the seal is compressed.**



T80411

Fig. 24-Install Seal

Install metal face seal half, with retainer lip first, into the seal bore in the roller shell (Fig. 24).

Be sure the seal is tight against the seal bore and sits straight.

**IMPORTANT:** The new rubber seal must have a retainer lip to hold the seal half in the bore before the seal is compressed.

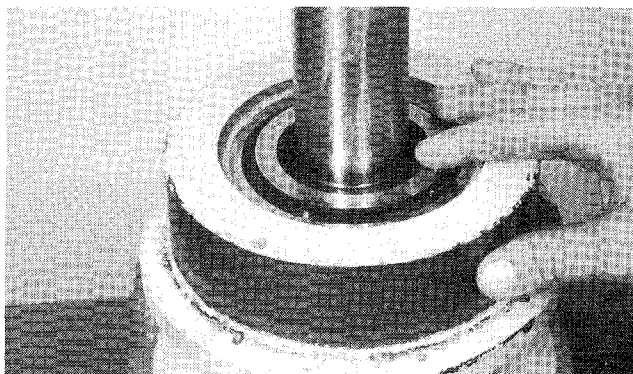

T80412

Fig. 25-Apply Oil

Wipe both metal seal ring faces dry with a lint free cloth.

Apply a thin film of oil, as used in the roller, to the shiny sealing area on both metal seal rings.

Be sure the rubber seals are free of oil.

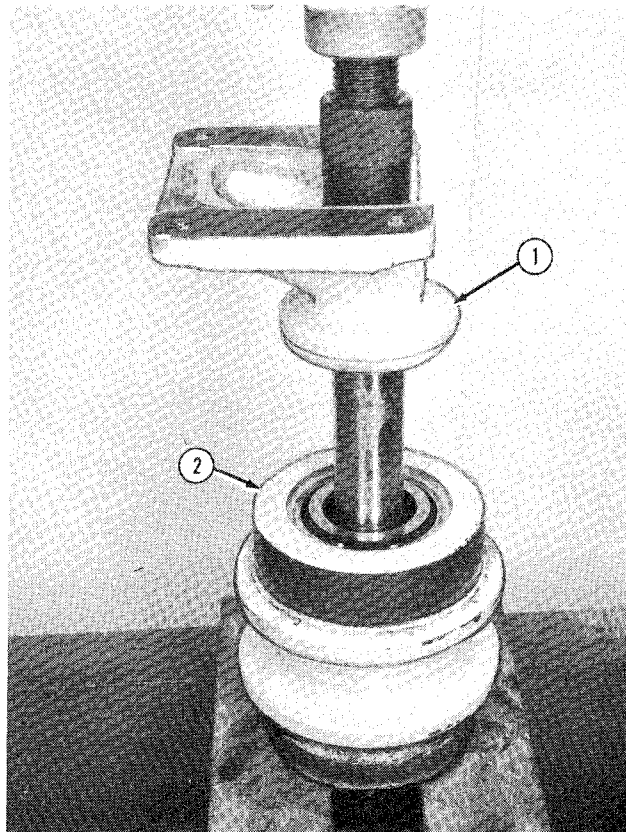

T80413

1—Support Bracket

2—Roller Shell

Fig. 26-Install Support Bracket

**IMPORTANT:** Hold the support bracket (1, Fig. 26) to prevent it from falling when the shaft of the support bracket is pressed below the bearing cone.

Install the support bracket into the roller shell (2) with a press.

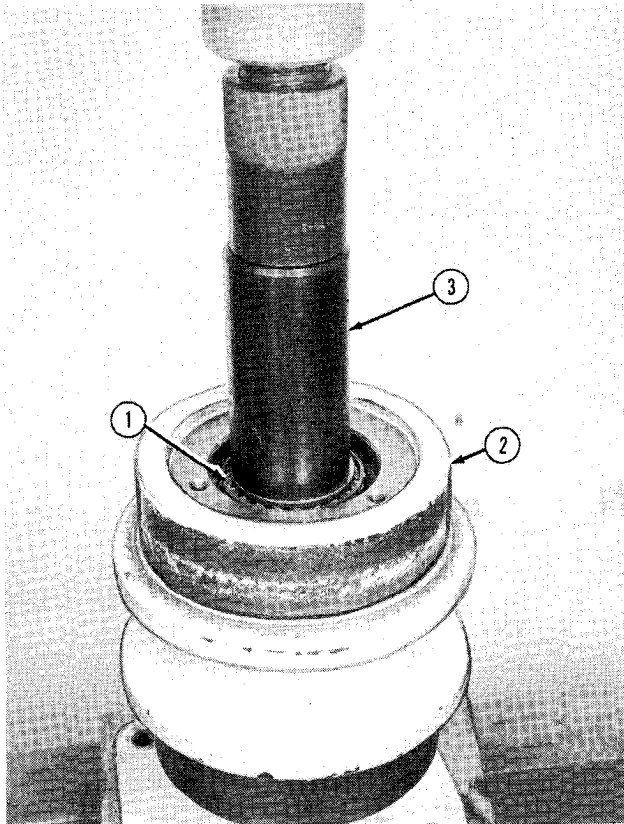

T80414

- 1—Bearing Cone
- 2—Roller Shell
- 3—JD-357

Fig. 27-Install Bearing Cone

Install bearing cone (1, Fig. 27) into the roller shell (2) with a JD-357 Driver (3) and a press.

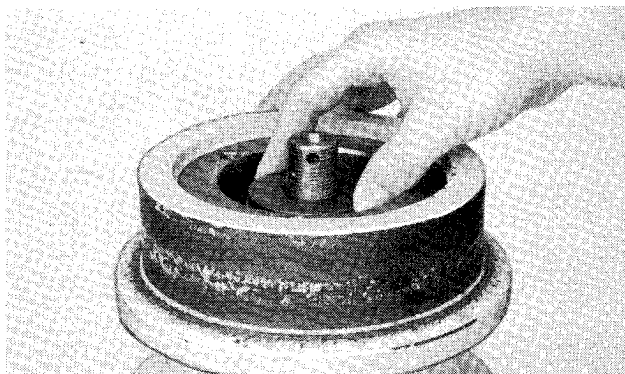

T80397

Fig. 28-Washer

Install washer (Fig. 28).

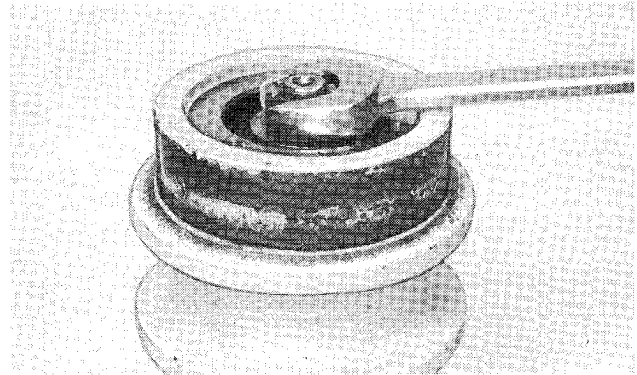

T80415

Fig. 29-Install Nut

Install nut (Fig. 29) and tighten slightly.

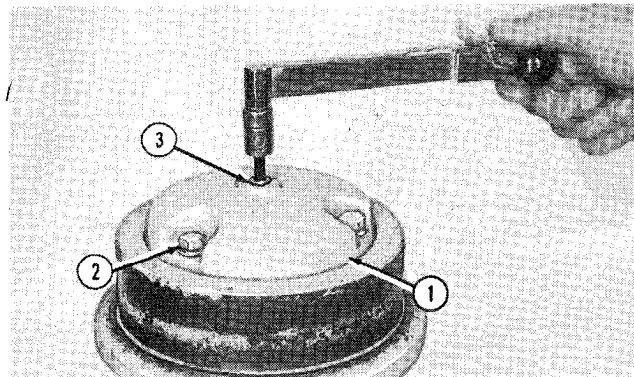

T80416

- 1—Cover
- 2—Cap Screw (3 used)
- 3—Oil Fill Plug

Fig. 30-Checking Rolling Drag Torque

Install cover (1, Fig. 30) and cap screws (2).

Use the oil fill plug (3) to check the rolling drag torque. The rolling drag torque of the carrier roller must be (7.6 to 8.2 N·m) 67 to 73 lb-in. If the rolling drag torque is not correct, remove cover and tighten or loosen nut (Fig. 29). Repeat rolling drag torque procedure.

Remove cover after rolling drag torque is correct.

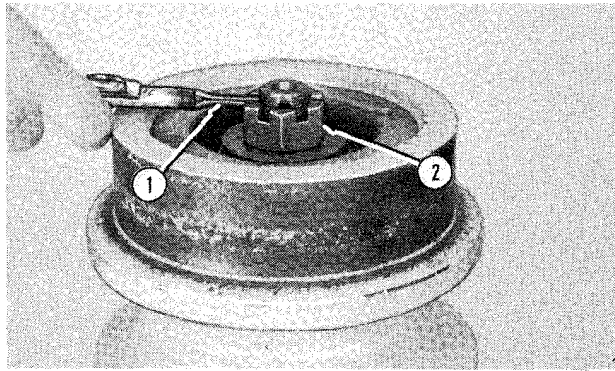

T80395

1—Cotter Pin

2—Nut

Fig. 31-Install Nut

Turn nut (2, Fig. 31) counterclockwise 1/4 turn and install cotter pin (1). This should result in (0.00 to 0.15 mm) 0.000 to 0.006 in. end play.

Add approximately (491 mL) 16.6 oz. of recommended oil to carrier roller cavity. (See Section 1, Group IV.)

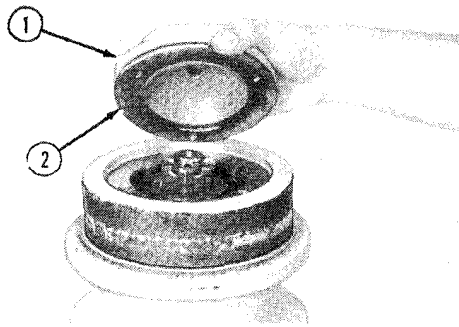

T80417

1—Cover

2—Gasket

Fig. 32-Install Cover

Install cover (1, Fig. 32) and a new gasket (2).

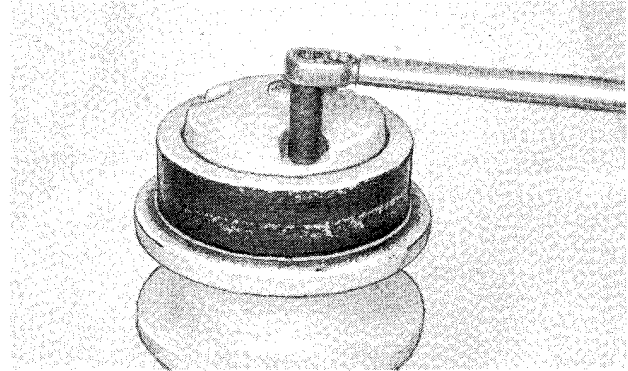

T80418

Fig. 33-Install Cap Screws

Apply Permatex Form-A-Gasket number 3 or an equivalent to roller cover cap screws and plug. Install lock washers and cap screws.

*NOTE: Carrier rollers require lubrication only at the time of assembly.*

See page 0130-68 to test carrier roller for leakage.

## INSTALLATION

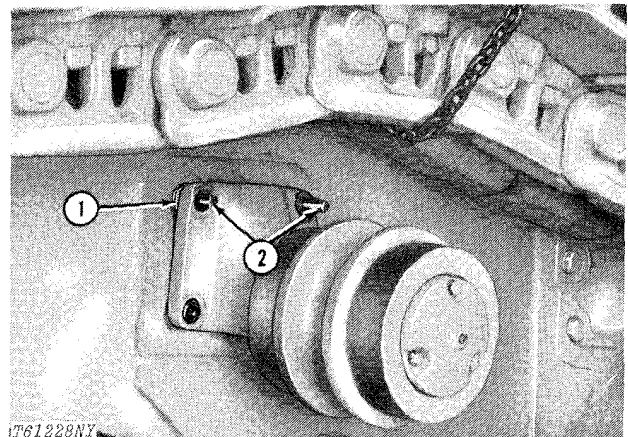

T81228NY

T61228NY

1—Shims

2—Guide Screws

Fig. 34-Install Carrier Roller

Install guide screws (2, Fig. 34).

Install the same number of shims (1) as was removed behind the carrier roller support. Install carrier roller and cap screws.

If carrier roller must be aligned, place the carrier roller on the guide screws without any shims.

Install shims on the bottom until carrier roller is level.

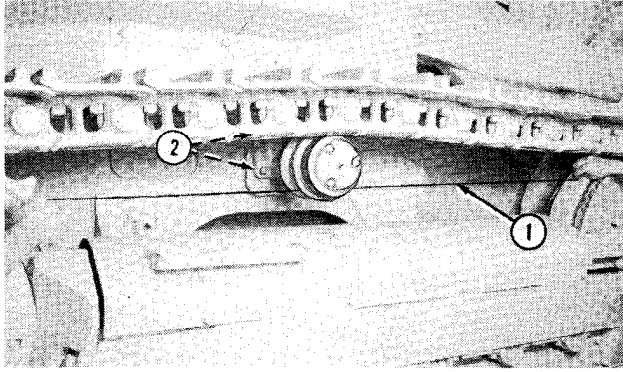

T80419

1—String

2—Shims (as required)

*Fig. 35-Aligning Carrier Roller*

Center the front idler in the track frame. Stretch a string (1, Fig. 35) tight between the center of the front idler flange and the center of the sprocket teeth.

Add an equal number of shims (2) on the top and bottom to bring the center line of the carrier roller out to the string.

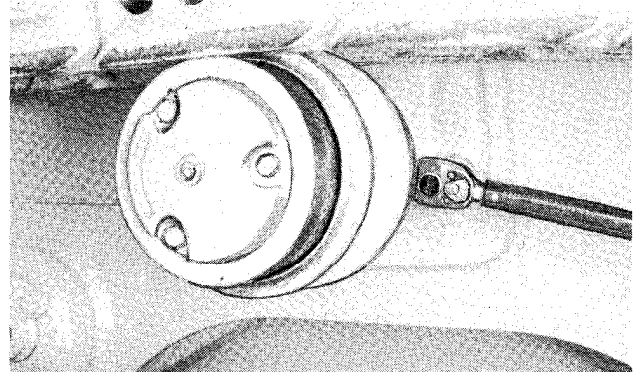

T80420

*Fig. 36-Install Cap Screws*

Install cap screws and washers. Tighten cap screws (230 N·m) 170 lb-ft.

Lower track onto carrier rollers.

See Group 9030 to adjust track tension.

# TRACK ROLLERS

## GENERAL INFORMATION

Six track rollers are used on each side to support the load of the crawler. The first, fourth and sixth rollers are single flanged. The second, third and fifth rollers are double flanged.

## CHECKING ROLLER WEAR

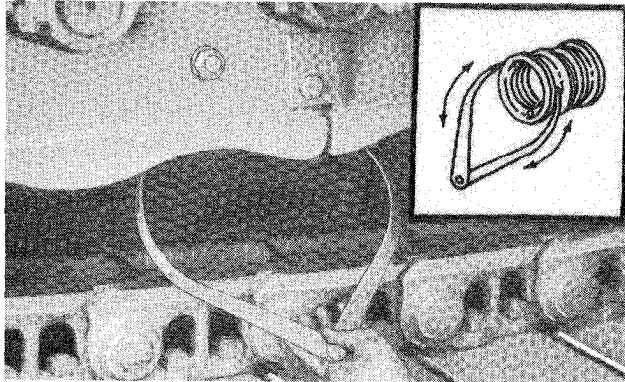

Fig. 37-Track Roller Diameter Measurement

T77885

Use D-05229ST (3048 mm) 12-in. Spring Caliper (part of D-05227ST Undercarriage Inspection Service Tool Kit) to measure track roller diameter.

Position a caliper around a track roller as shown in Fig. 37. Record the measurement. Repeat the procedure for each roller.

Track roller diameter of a new roller is (203 mm) 7.99 in. Minimum recommended roller diameter is (184.2 mm) 7.25 in.

*NOTE: For additional information on measuring track roller diameter, refer to UNDERCARRIAGE APPRAISAL MANUAL SP-236.*

*NOTE: It is recommended to use the previous procedures for more accurate measurements when replacing the track components. A track wear gauge (JD329-1) is available, enabling the service technician to quickly check the condition of a track assembly.*

Use JD329-1 Track Wear Gauge to check wear on track roller.

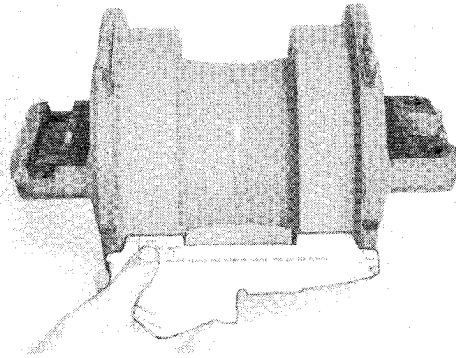

Fig. 38-Track Roller Wear

T79866

The track rollers will wear on the roller running surface and the inner surface of the flanges. Place gauge between the roller flanges tight against one flange. Measure gap between gauge and roller running surface and gap between gauge and flange. Allowable wear is indicated on gauge with an arrow pointing to surface where gap is to be measured.

## REMOVAL

See page 0130-33 to release track tension.

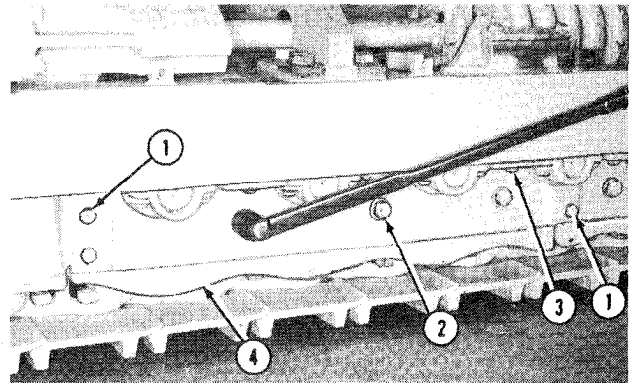

- 1—Cap Screw (6 used)
- 2—Cap Screw (6 used)
- 3—Cap Screw (6 used)
- 4—Left Rock Guard

T80421

Fig. 39-Rock Guards

Remove cap screws (1, 2 and 3, Fig. 39) and nuts to remove left rock guard (4) and right rock guard.



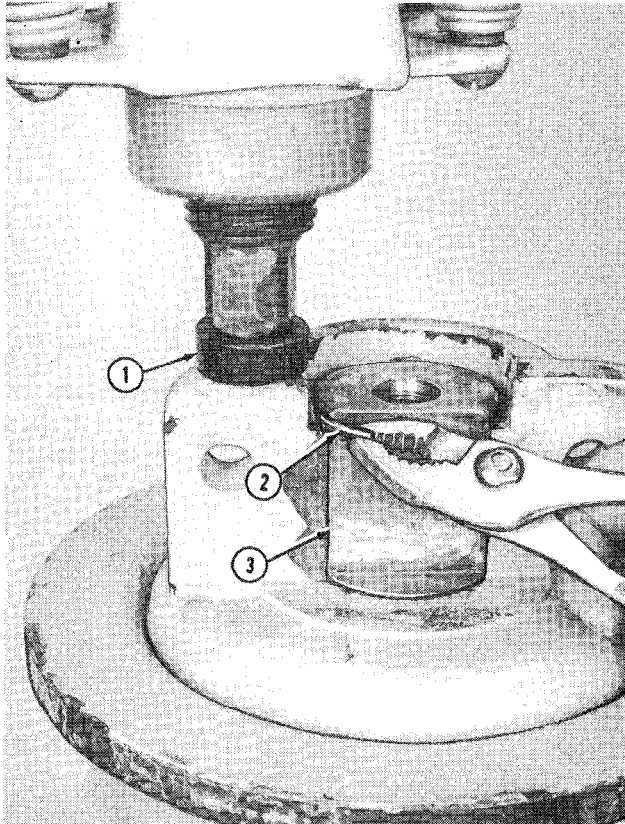

1—27505 Disk  
2—Snap Ring

3—Roller Shaft

T80426

Fig. 44-Remove Snap Rings

Use a 27505 disk (1, Fig. 44) from the D-01045AA driver set and a press to compress the metal face seals slightly. Remove the snap ring (2) from both sides of roller shaft (3).

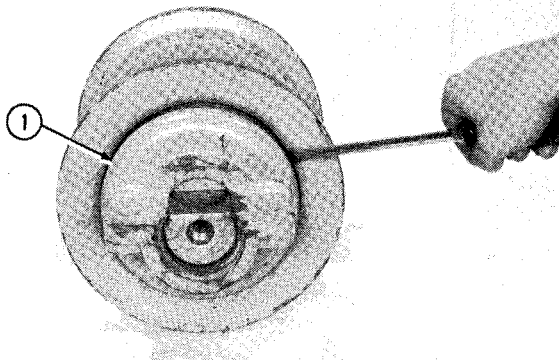

1—Outer Collar

T80427

Fig. 45-Remove Collars

Remove outer collar (1, Fig. 45) and inner collar.

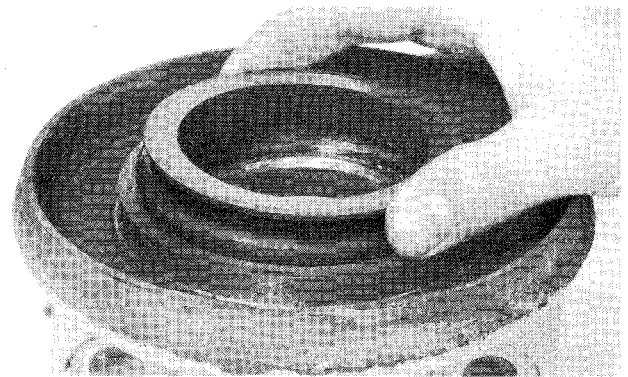

T80428

Fig. 46-Remove Seal

Remove metal face seal (Fig. 46) from inner and outer collars.

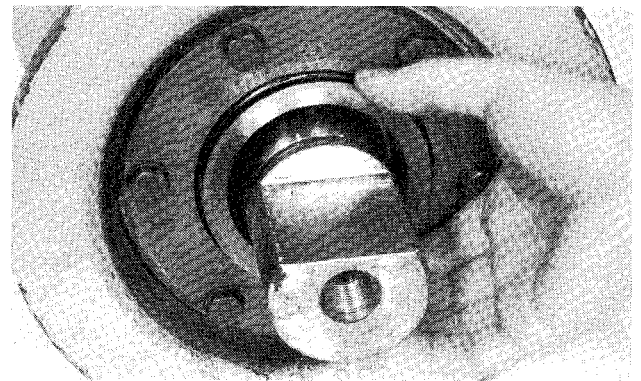

T80429

Fig. 47-Remove Seal

Remove metal face seal from both bushing cases (Fig. 47). Tape the metal face seals together to keep them in matched sets.

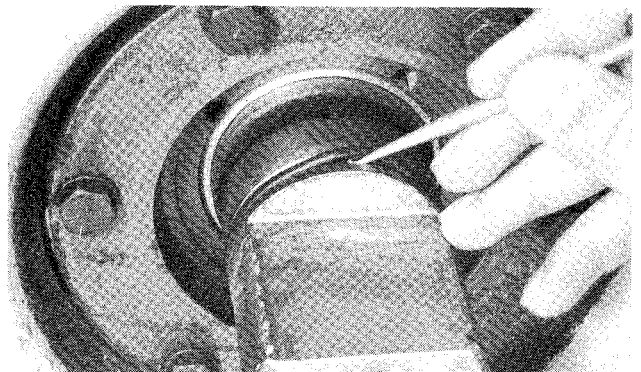

T80430

Fig. 48-Remove O-Ring

Remove O-rings (Fig. 48).

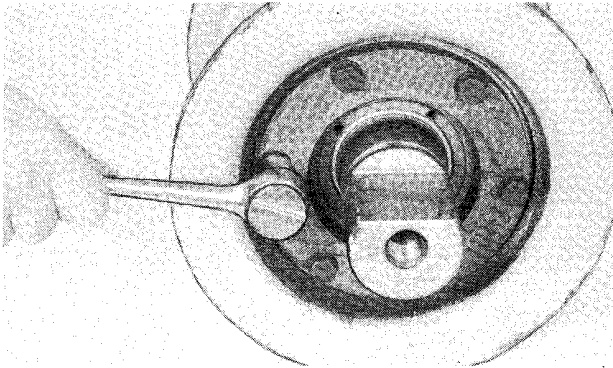

T80431

Fig. 49-Bushing Case Cap Screws

Remove cap screws (Fig. 49).

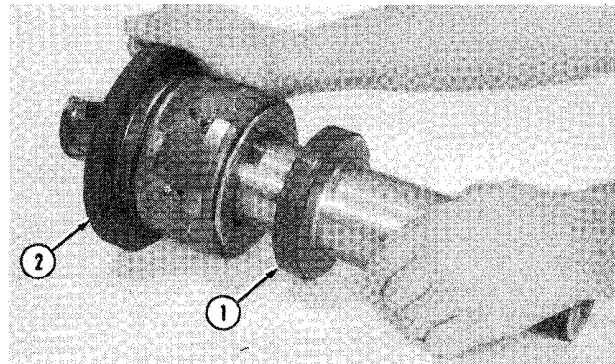

T80433

1—Roller Shaft 2—Bushing Case

Fig. 51-Remove Roller Shaft

Remove roller shaft (1, Fig. 51) from bushing case (2).

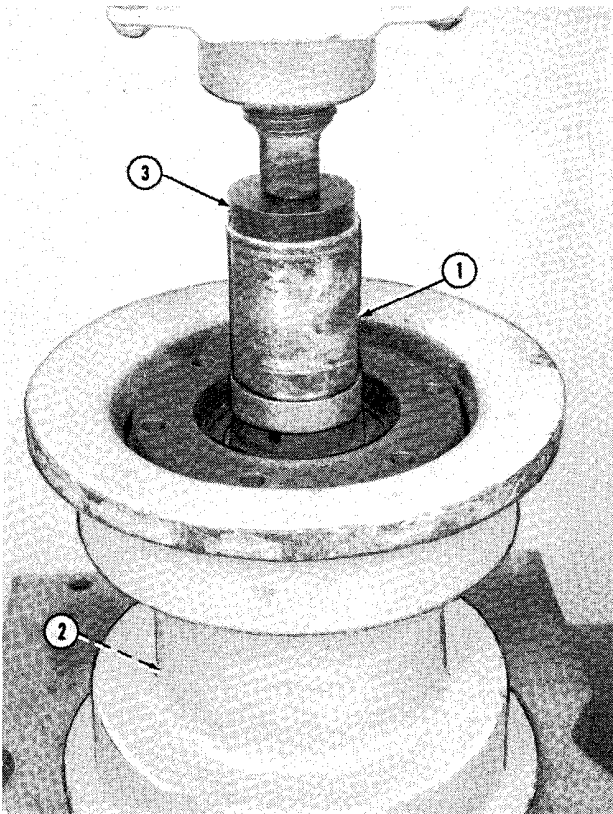

T80432

1—Roller Shaft 2—Bushing Case  
3—27518 Disk

Fig. 50-Remove Bushing Case

Remove roller shaft (1, Fig. 50) and bushing case (2) with a 27518 disk (3) from the D-01045AA driver set and a press.

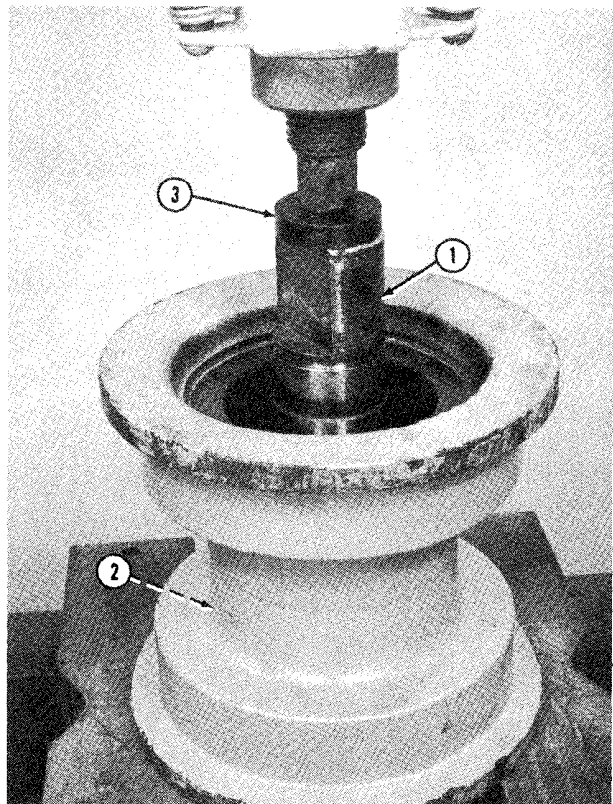

T80434

1—Roller Shaft 2—Bushing Case  
3—27518 Disk

Fig. 52-Remove Bushing Case

Turn roller over. Install roller shaft (1, Fig. 52).

Remove roller shaft and bushing case (2) with a 27518 disk (3) and a press.

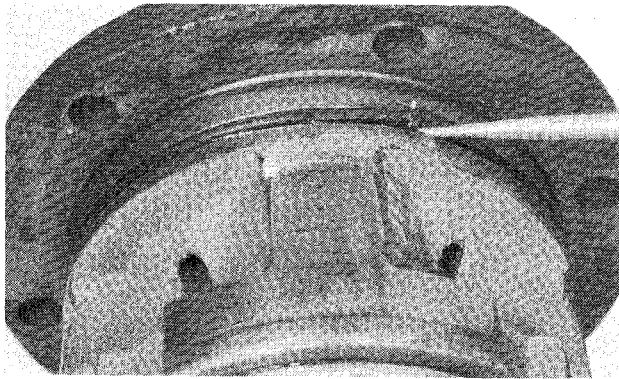

T80435

Fig. 53-Remove O-Ring

Remove O-ring (Fig. 53).

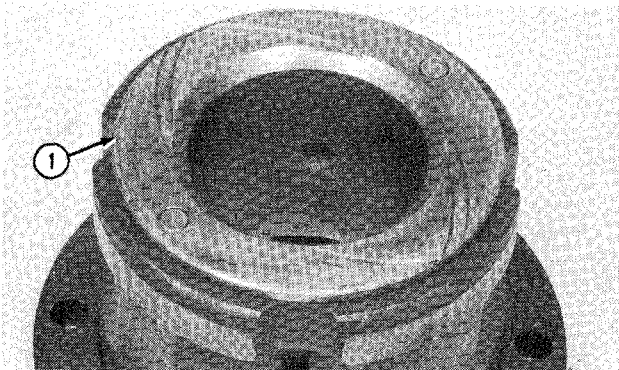

T80436

1—Bushing

Fig. 54-Inspect Bushing

Inspect bushing (1, Fig. 54) for scoring or excessive wear.

**NOTE: DO NOT remove bushing from bushing case unless replacement of parts is necessary.**

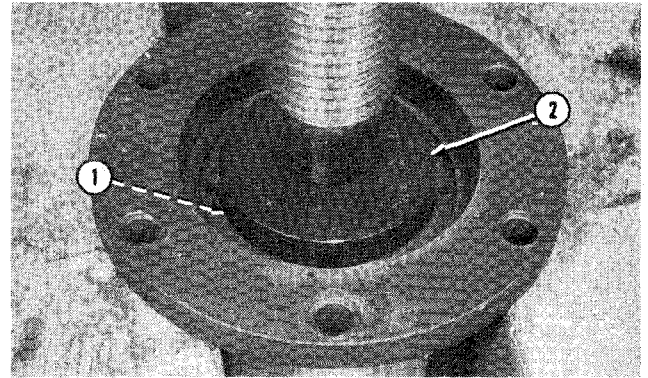

T80437

1—Bushing

2—27527 Disk

Fig. 55-Remove Bushing

Remove bushing (1, Fig. 55) with a 27527 disk (2) from the D-01045AA driver set and a press.

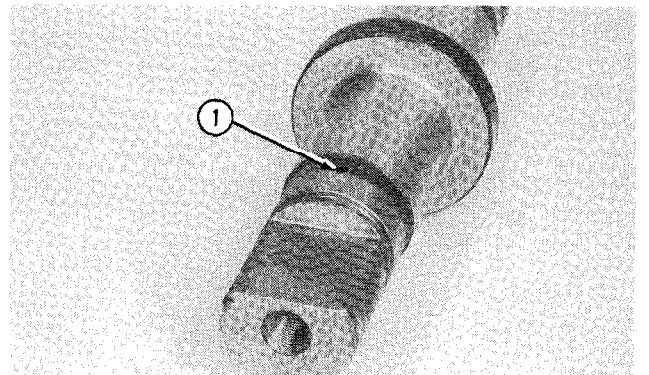

T80438

1—Oil Passage

Fig. 56-Roller Shaft

Inspect roller shaft for damage or excessive wear. Be sure oil passage (1, Fig. 56) is clean and open.

Replace all parts as needed.

After removal of sealing rings, inspect sealing ring pattern to find out if seals can be reused. Refer to the steps and figures below to determine the condition of the metal rings.

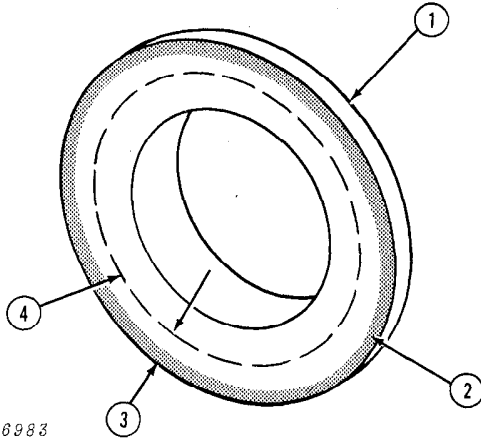

T66983

- 1—Metal Seal Ring
- 2—Sealing Area (shaded portion)
- 3—Outer Half of Sealing Face
- 4—Center of Sealing Face

Fig. 57-A Good Sealing Ring

The following three steps are specifications which determine a good sealing ring.

1. The narrow, highly polished sealing area (2, Fig. 57) must be within outer half of the sealing face (3).
2. The sealing area (2) must be uniform and concentric with the I.D. and O.D. of metal seal ring (1).
3. The sealing area must not be chipped or scratched in any way.

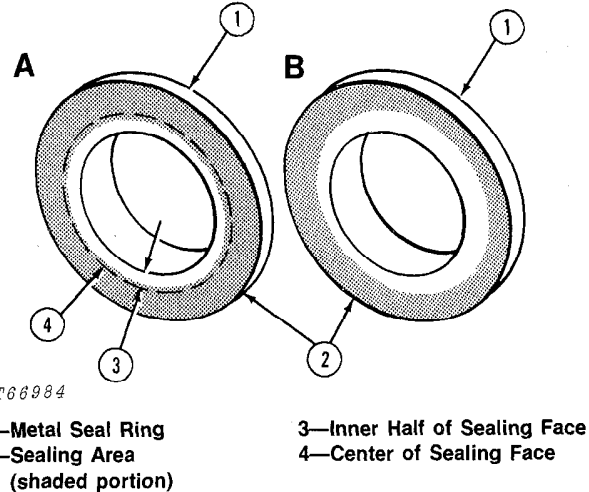

T66984

- 1—Metal Seal Ring
- 2—Sealing Area (shaded portion)
- 3—Inner Half of Sealing Face
- 4—Center of Sealing Face

Fig. 58-A Poor Sealing Ring

The two drawings in Fig. 58 show examples of poor metal seal rings.

Drawing A (Fig. 58) shows the sealing area (2) within inner half of sealing face (3).

Drawing B (Fig. 58) shows the sealing area (2) not concentric with I.D. and O.D. of metal seal ring (1).

Clean the metal sealing rings as follows:

Remove any corrosion or hardened material that may exist on the metal ring other than the sealing area. Use a scraper and/or any stiff bristled fiber brush to remove the foreign material from the surface.

Wash the metal sealing rings with a volatile, non-petroleum base type solvent to remove all oil and wipe dry. Use the lint free wiper furnished in the new seal package to remove all traces of oil or grease from all surfaces.

**NOTE:** If metal rings appear to be useable, keep the two metal face seals together as matched sets. If the metal rings are not within proper specifications, **DO NOT** rebuild the seal, use a completely new seal.

**Assembly**

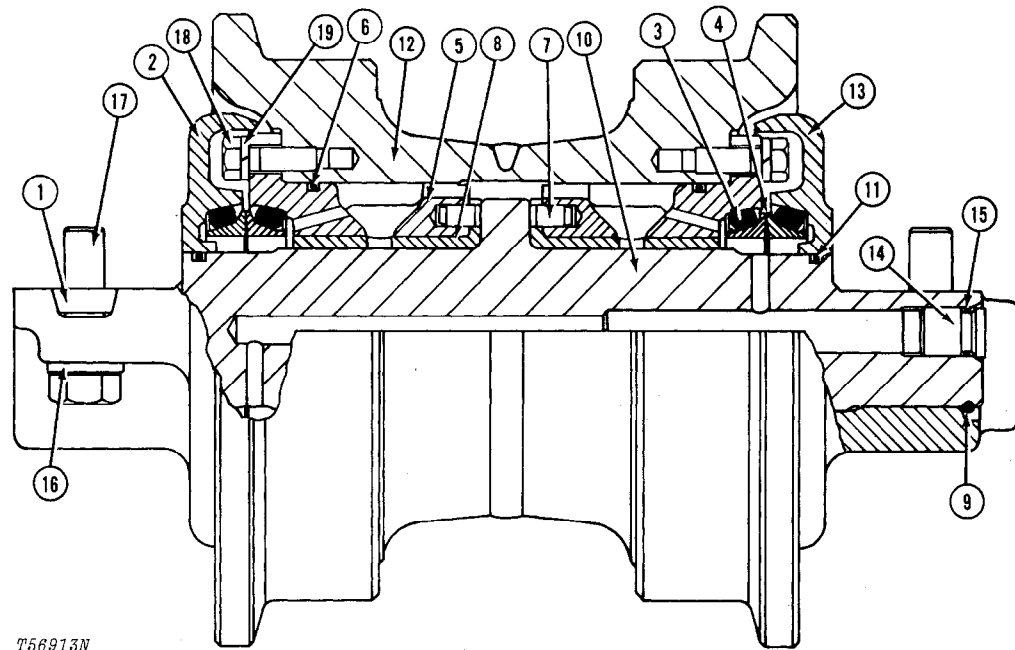

T56913N

T56913N

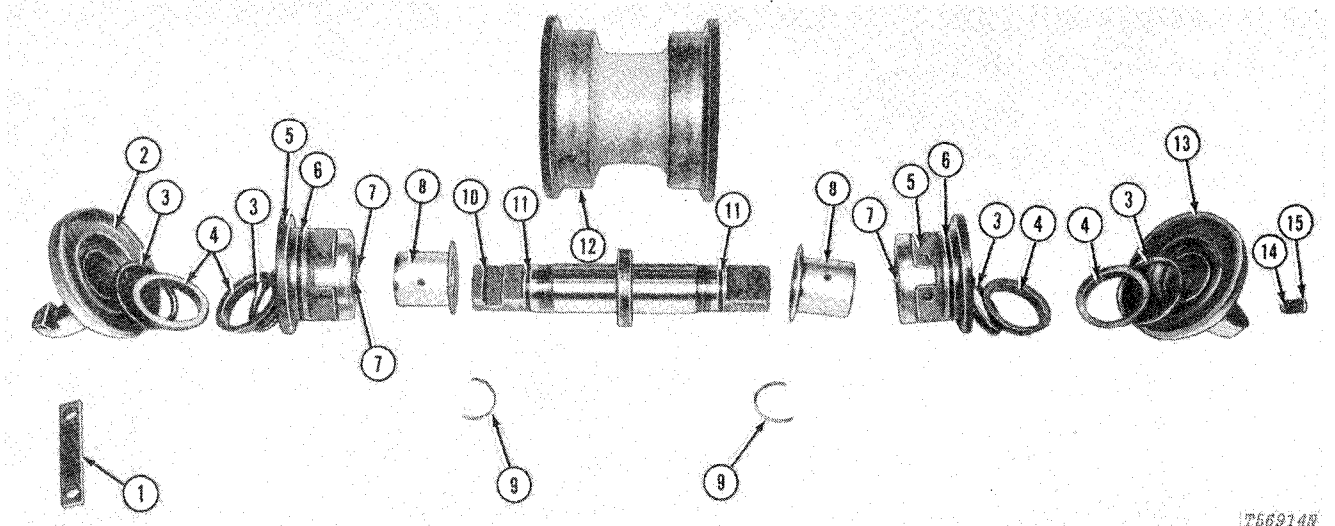

T56914N  
 T56914N

- |                   |                 |                 |                |
|-------------------|-----------------|-----------------|----------------|
| 1—Lock            | 6—O-Ring        | 11—O-Ring       | 16—Lock Washer |
| 2—Inner Collar    | 7—Dowel Pin     | 12—Roller       | 17—Cap Screw   |
| 3—O-Ring          | 8—Bushing       | 13—Outer Collar | 18—Cap Screw   |
| 4—Metal Face Seal | 9—Snap Ring     | 14—Plug         | 19—Lock Washer |
| 5—Bushing Case    | 10—Roller Shaft | 15—O-Ring       |                |

Fig. 59-Track Roller Assembly

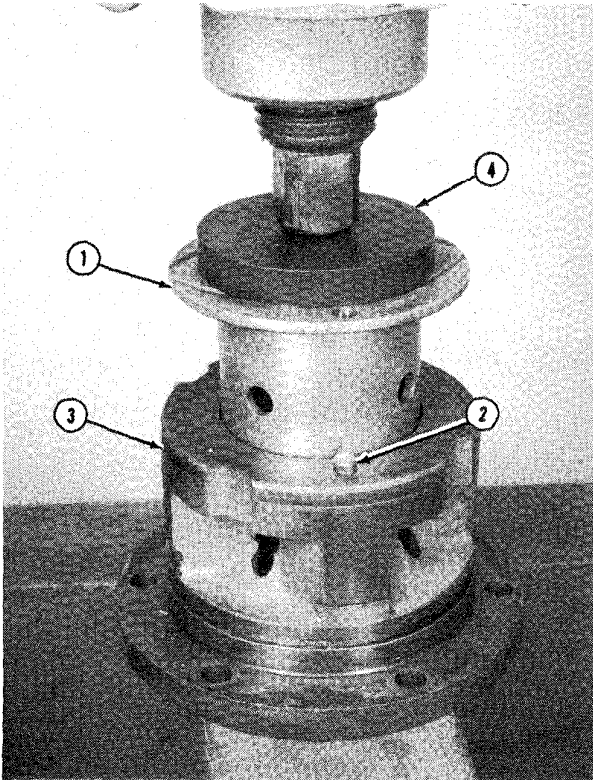

T80439

- |             |                |
|-------------|----------------|
| 1—Bushing   | 3—Bushing Case |
| 2—Dowel Pin | 4—27534 Disk   |

Fig. 60-Install Bshing

Align the holes in the bushing flange (1, Fig. 60) with the dowel pins (2) in the bushing case (3).

Install bushing with a 27534 disk (4) from the D-01045AA Driver Set and a press.

**NOTE:** If the dowel pins and bushing flange holes cannot be aligned, follow step 1 or 2.

1. Heat the bushing case to (149°C) 300 °F before installing bushing. This will expand the bushing case allowing alignment of the holes in the bushing flange with the dowel pins in the bushing case.

2. Remove dowel pins. Turn bushing 90° to align oil holes in bushing with holes in bushing case. Install bushing with a press. Drill new holes in the bushing case using the holes in the bushing flange as a guide. The holes must be (7.80 mm) 0.308 in. in diameter and (6.4 mm) 0.25 in. deep. Install dowel pins (0.76 mm) 0.030 in. below surface of bushing.

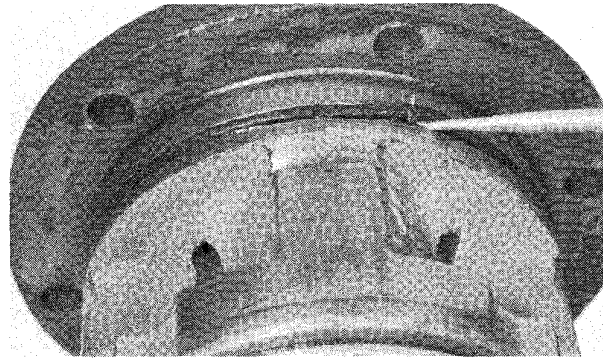

T80435

Fig. 61-Install O-Ring

Install a new O-ring (Fig. 61) on bushing cases.

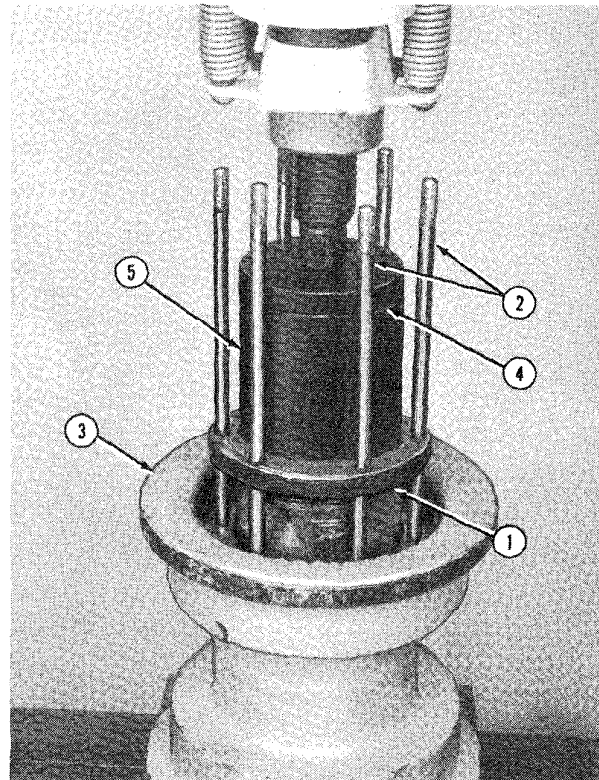

T80440

- |                                     |              |
|-------------------------------------|--------------|
| 1—Bushing Case                      | 3—Roller     |
| 2—JDG-180 Bushing<br>Aligning Studs | 4—27551 Disk |
|                                     | 5—Pipe       |

Fig. 62-Install Bushing Case

Install bushing case (1, Fig. 62) with JDG-180 Bushing Aligning Studs (2), 27551 disk (4) and a press.

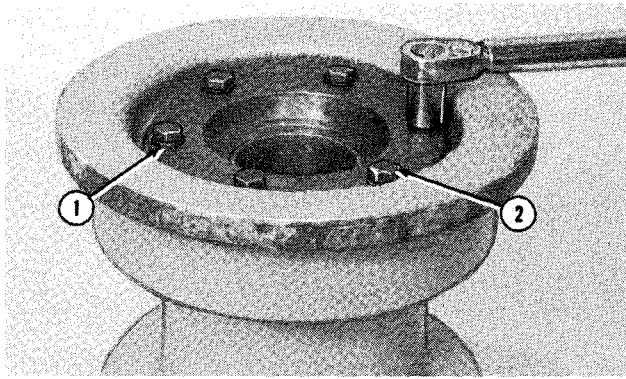

T80441

1—Lock Washer (6 used)      2—Cap Screw (6 used)

Fig. 63-Bushing Case Cap Screws

Install lock washers (1, Fig. 63) and cap screws (2). Tighten cap screws.

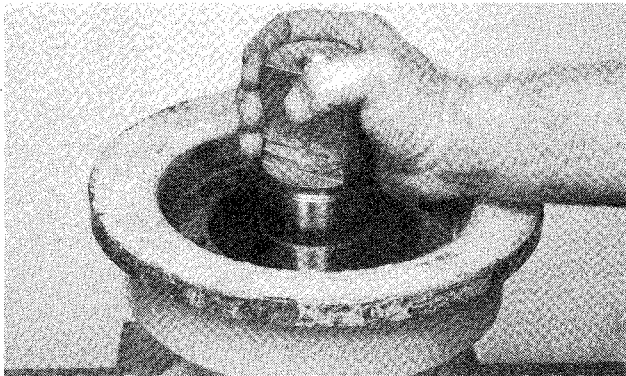

T80442

Fig. 64-Install Roller Shaft

Turn roller over. Install roller shaft (Fig. 64).

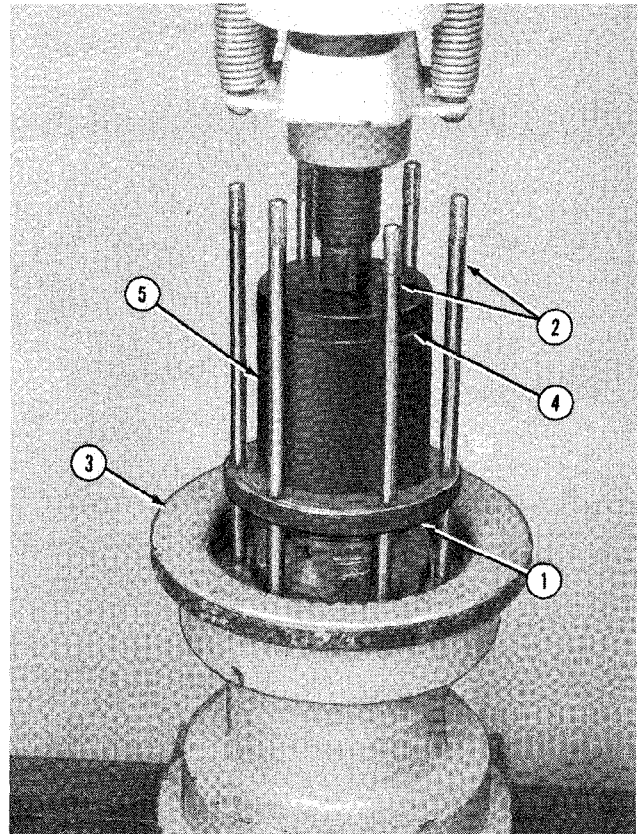

T80440

1—Bushing Case                      3—Roller  
 2—JDG-180 Bushing              4—27551 Disk  
 Aligning Studs                      5—Pipe

Fig. 65-Install Bushing Case

Install bushing case (1, Fig. 62) with JDG-180 Bushing Aligning Studs (2), a 27551 disk (4) and a press.

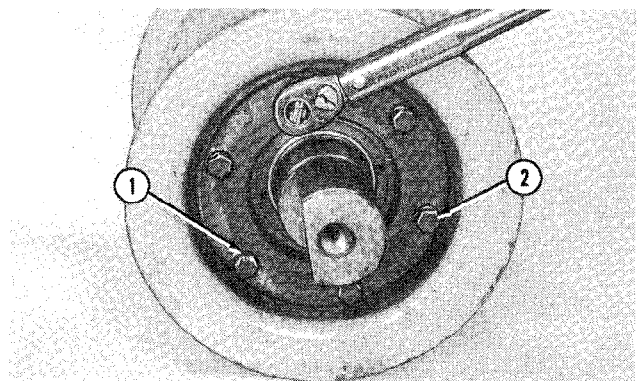

T80443

1—Lock Washer (6 used)              2—Cap Screw (6 used)

Fig. 66-Bushing Case Cap Screws

Install lock washers (1, Fig. 66) and cap screws (2). Tighten cap screws.

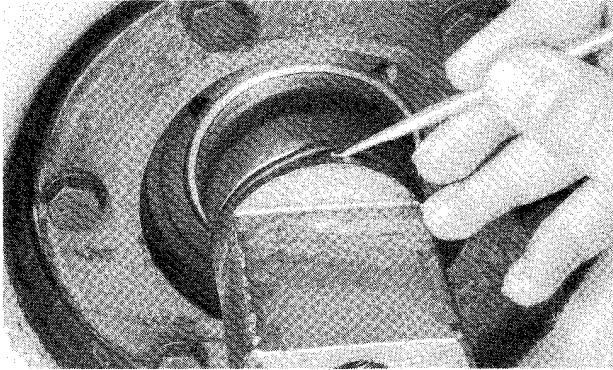

T80430

Fig. 67-Install O-Ring

Install new O-rings (Fig. 67).

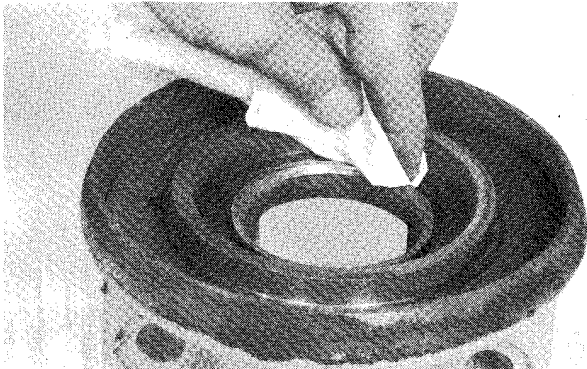

T80572

Fig. 68-Collar Bore

Degrease seal bore in inner and outer collars (Fig. 68) with a volatile, non-petroleum base type solvent. Be sure seal bores are clean and dry.

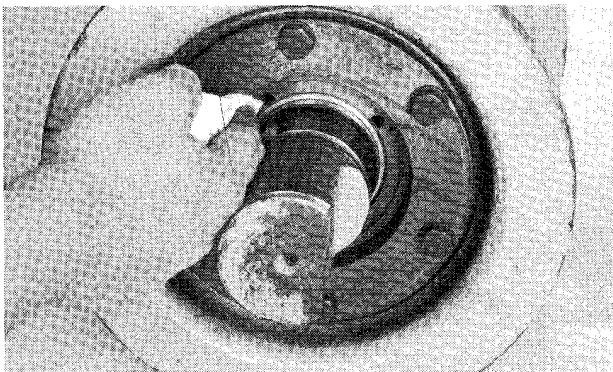

T80573

Fig. 69-Bushing Case Bore

Degrease seal bore in bushing cases (Fig. 69) with a volatile, non-petroleum base-type solvent. Be sure seal bores are clean and dry.

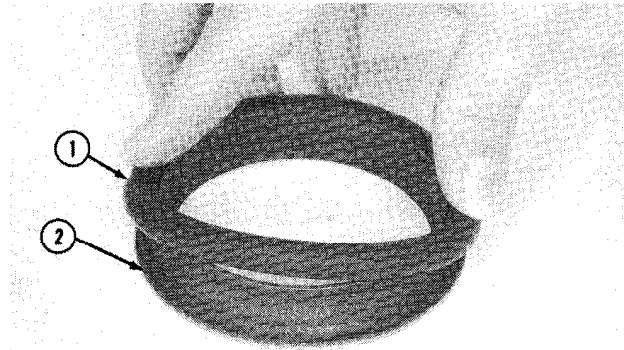

T80574

1—Rubber Seal

2—Metal Seal Ring

Fig. 70-Metal Face Seal

**IMPORTANT:** The metal face seal must be extremely clean during assembly. Use a volatile, non-petroleum base-type solvent to clean the metal seal ring (2, Fig. 70) and rubber seal (1). DO NOT keep the rubber seal in a volatile, non-petroleum base-type solvent for more than 1 minute. Wipe the seals dry with lint-free tissue to remove finger prints and foreign material.

Install the rubber seal on the metal seal ring. Be sure the rubber seal sits evenly on the metal seal ring.

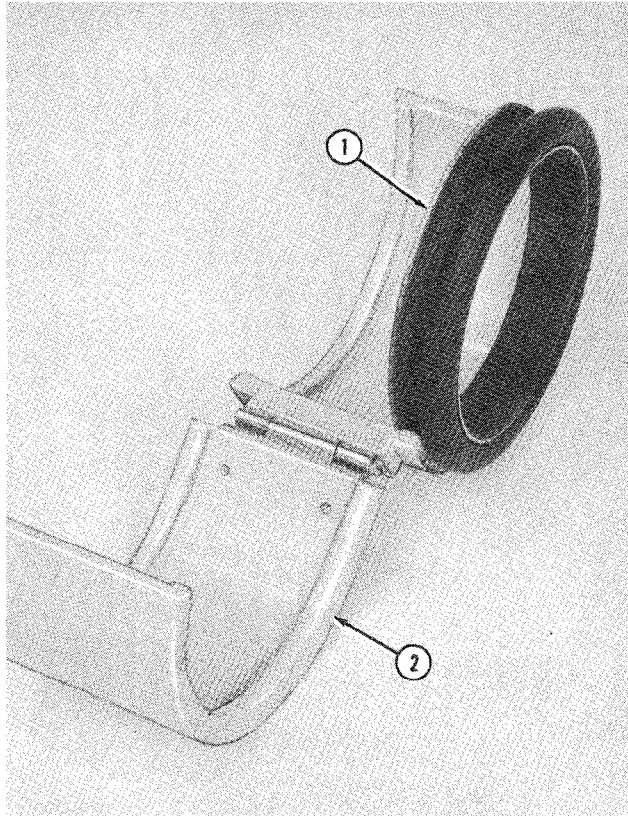

1—Metal Seal Ring      2—JD-203 Seal Installation Tool

Fig. 71-Seal Installation Tool

Install the metal seal ring (1, Fig. 71) in the groove of the JD-203 Seal Installation Tool (2).

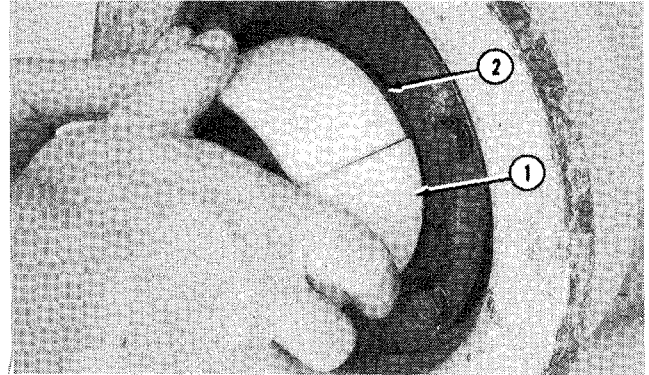

1—JD-203 Seal Installation Tool      2—Rubber Seal

Fig. 72-Install Metal Face Seal

To aid seal installation, put a volatile, non-petroleum base type solvent on the rubber seal (2, Fig. 72) and seal bore retainer lip. The solvent **MUST NOT** damage the rubber seal or leave an oily residue on the seal or seal bore.

Install the metal face seal with JD-203 Seal Installation Tool (1). Push down on the tool with a uniform pressure until the rubber seal is below the retainer lip in the seal bore. Turn the tool clockwise and counter-clockwise while the final downward pressure is applied. This will help seat the rubber seal uniformly.

Check seal position after installation. Be sure the metal seal ring sits square in the seal bore. Be sure the rubber seal is seated uniformly in the seal bore below the retainer lip.

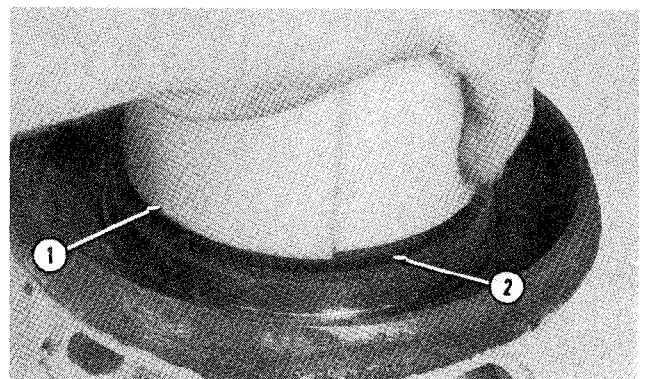

1—JD-203 Seal Installation Tool      2—Rubber Seal

Fig. 73-Install Metal Face Seal

Install the metal face seal in outer and inner collars with JD-203 Seal Installation Tool (1, Fig. 73) following the above procedure.

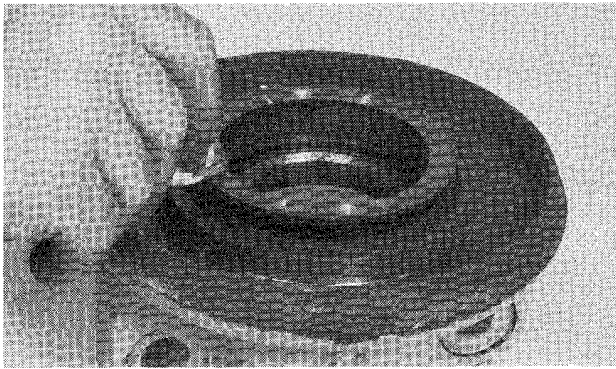

T80578

Fig. 74-Apply Oil

Wipe metal seal rings dry with a lint free tissue.

Apply a thin film of oil, as used in the roller, to the shiny sealing area on metal seal rings.

Be sure the rubber seals are free of oil.

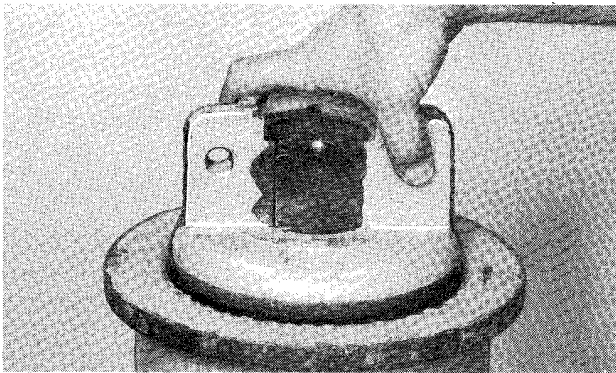

T80579

Fig. 75-Install Collar

Install outer collar (Fig. 75).

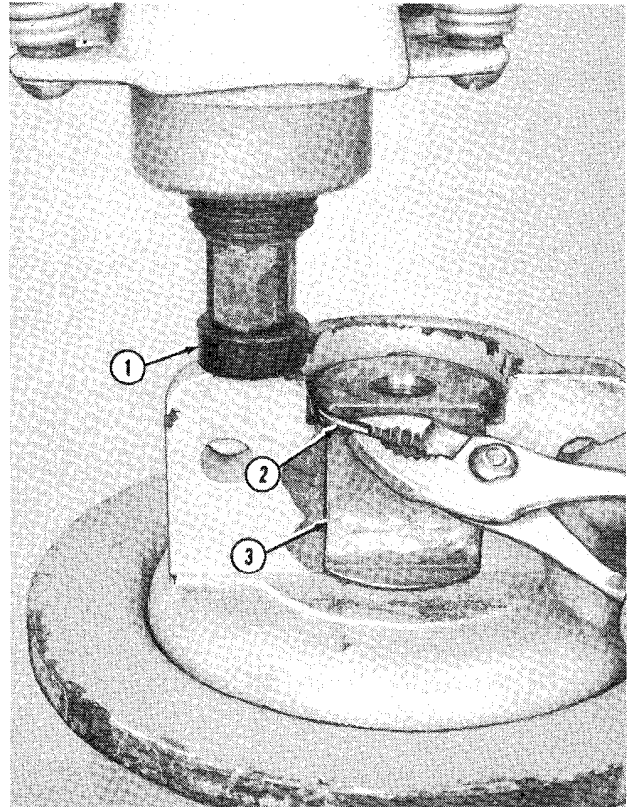

T80426

1—27505 Disk  
2—Snap Ring

3—Roller Shaft

Fig. 76-Install Snap Ring

Compress the metal face seals slightly with a 27505 disk (1, Fig. 76) from the D-01045AA driver set and a press. Install snap ring (2).

Remove roller from press. Install inner collar and snap ring in the same manner.

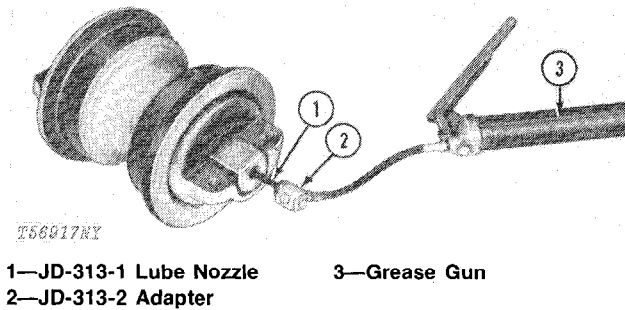

Fig. 77-Filling Roller With Oil

Use a JD-313 Lube Nozzle Kit (Fig. 77) and fill the track roller with (379 mL) 12.8 oz. of recommended oil. (See Section I, Group IV.)

Thoroughly clean the nozzle and around the plug end of the track roller shaft.

Insert the nozzle in the roller shaft as far as it will go.

Force oil slowly through the nozzle and into the shaft until oil without air bubbles is seen leaking past the flat on the nozzle with the flat up.

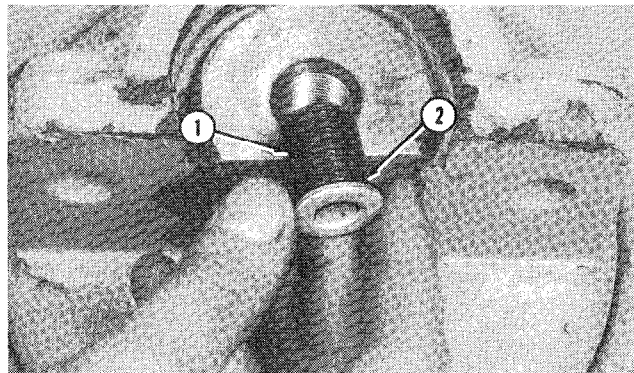

1—Plug  
2—O-Ring

Fig. 78-Install Plug

Remove the nozzle. Install new O-ring (2, Fig. 78) and plug (1).

**NOTE:** Track rollers require oil only at the time of assembly.

See P. 0139-67 to test track roller for leakage.

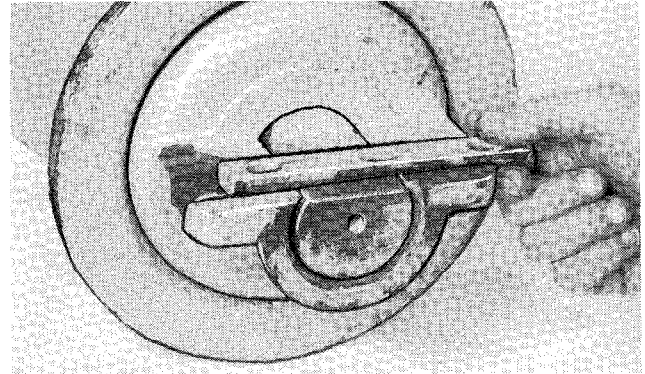

Fig. 79-Install Lock

Install lock (Fig. 79).

## INSTALLATION

**NOTE:** Locate single flange track rollers in the first, fourth, and sixth position on track frame. Locate double flange track rollers in the second, third and fifth position.

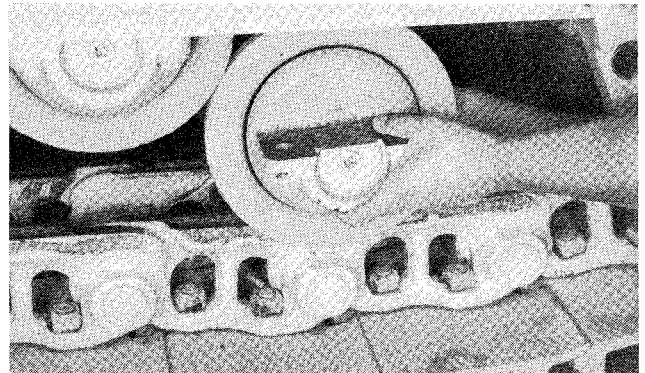
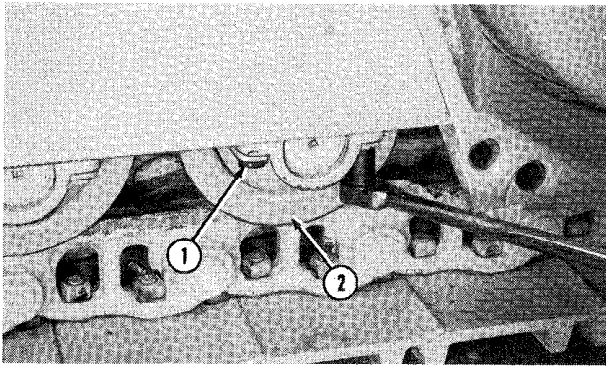

Fig. 80-Install Roller

Install the track roller (Fig. 80) with oil fill plug to outside.

Lower the crawler using a service jack or hoist until the roller cap screws can be installed.



T80581

1—Cap Screw (4 used) 2—Track Roller

Fig. 81-Install Roller Cap Screws

Install cap screws (1, Fig. 81) and tighten to (325 N·m) 240 lb-ft.

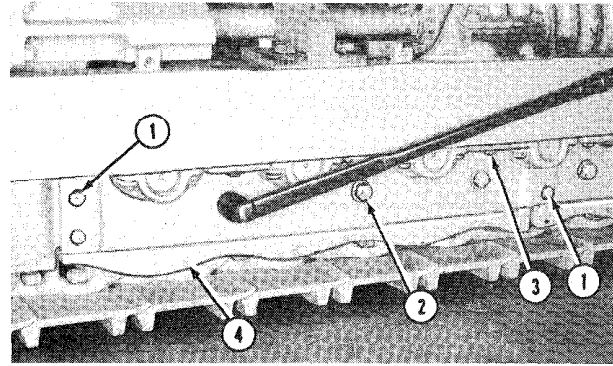

T80421

1—Cap Screw (6 used) 3—Cap Screw (6 used)  
2—Cap Screw (6 used) 4—Left Rock Guard

Fig. 83-Rock Guards

Fasten left rock guard (4, Fig. 83) and right rock guard with cap screws (1, 2 and 3) and nuts.

See Group 9030 to adjust track tension.

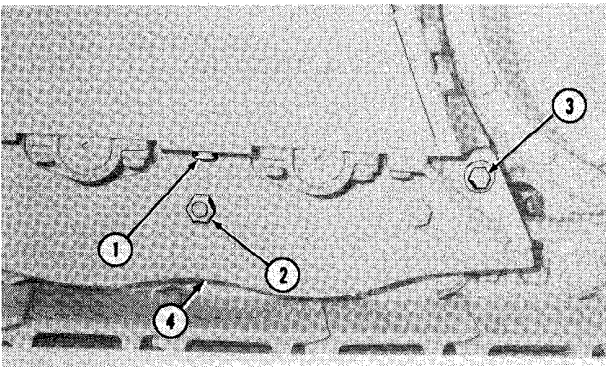

T81513

1—Cap Screw (6 used) 3—Cap Screw (2 used)  
2—Nut (6 used) 4—Left Track Guide

Fig. 82-Track Guide

Use T43513 John Deere LOCTITE Thread Lock and Sealer (High Strength) or an equivalent on track guide and rock guard cap screws before installation.

Fasten left track guide (4, Fig. 81) and right track guide with cap screws (1 and 3) and nuts (2).

## TRACK SHOES

### GENERAL INFORMATION

Two bar semi-grouser track shoes are used on the 655 Crawler in a (381 mm) 15-in. width.

### MEASURING GROUSER WEAR

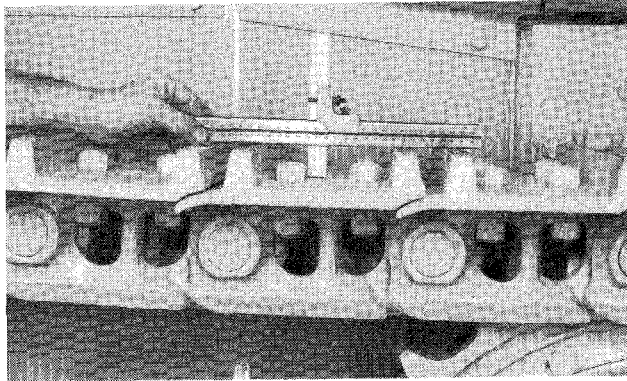

Fig. 84-Grouser Bar Measurement

T77886

Measure grouser bar height with a depth gauge consisting of D-05231ST 300 mm Metric Ruler, D-05265ST 150 mm Metric Ruler and D-05266ST Right Angle Attachment (part of D-05227ST Undercarriage Inspection Service Tool Kit).

Place the depth gauge over grouser bar as shown in Fig. 84. Repeat the measurement for several grousers and record the average depth.

Standard grouser height on a new shoe is (31 mm) 1.22 in. Minimum recommended standard grouser height is (15 mm) 0.59 in.

*NOTE: For additional information on measuring grouser bar height, refer to UNDERCARRIAGE APPRAISAL MANUAL SP-326.*

### REMOVAL

Remove bolts and nuts securing track shoe to link.

Remove shoe.

### REPAIR

Inspect shoes for excessive grouser wear, cracks, or broken shoes.

Replace shoes as necessary.

### INSTALLATION

Track shoe mounting surfaces of links and shoes must be clean and free of paint.

Lubricate bolt threads and the bearing surface of the head.

Install track shoes and bolts.

Install nuts with the rounded corners towards link, track shoes, and bolts.

Use the following procedure to tighten shoe bolts.

1. Tighten bolts to (298 N·m) 220 lb-ft. Then rotate the bolts an additional 1/3 turn.
2. Check bolts after 75 hours of operation. They should have a minimum torque of (569 N·m) 420 lb-ft.
3. If bolts check below (569 N·m) 420 lb-ft, remove shoes and clean paint or other foreign material from chain and shoe mating surfaces.
4. Assemble shoes, lubricate bolts and repeat step 1.

## TRACK CHAIN ASSEMBLY

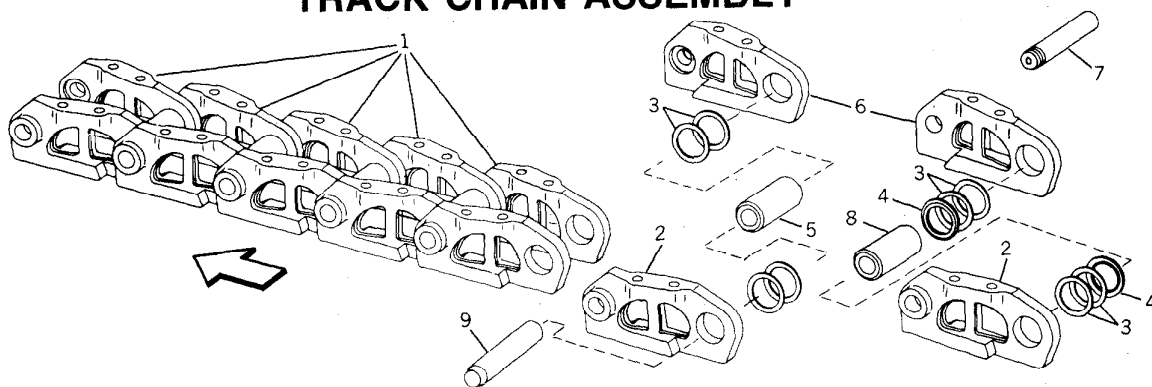

T61235N

T61235N

1—Track Chain  
2—Left Track Link (40 used)  
3—Seals (160 used)

4—Master Bushing Spacer (2 used)  
5—Track Bushing (39 used)  
6—Right Track Link (40 used)

7—Track Master Pin  
8—Track Master Bushing  
9—Track Pin (39 used)

Fig. 85-Track Chain Assembly

### GENERAL INFORMATION

The 655 uses a heavy-duty, sealed track chain. The seals help prevent dirt from entering the bushing bore which extends the life of the chain.

### MEASURING CHAIN WEAR

Measure the track components in as many positions as possible on both sides of the undercarriage.

This procedure will give a more accurate condition of the track.

#### Link Height

Measure link height with a depth gauge consisting of D-05231ST 300 mm Metric Ruler, D-05265ST 150 mm Metric Ruler and D-05266ST Right Angle Attachment (part of D-05227ST Undercarriage Inspection Service Tool Kit).

Position a depth gauge over a track link as shown in Fig. 86. Record the measurement. Repeat the measurement for several links.

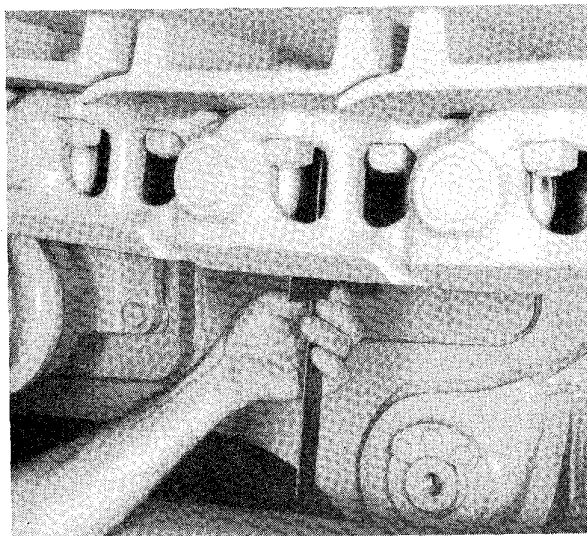

T77887

Fig. 86-Link Height Measurement

Link height of a new chain is (103.1 mm) 4.06 in. Minimum recommended link height is (93.7 mm) 3.69 in.



**Suggest:**

**If the above button click is invalid.**

**Please download this document**

**first, and then click the above link**

**to download the complete manual.**

**Thank you so much for reading**

*NOTE:* Additional information on measuring link height, refer to UNDERCARRIAGE APPRAISAL MANUAL SP-236.

*NOTE:* It is recommended to use the previous procedure for more accurate measurements when replacing the track components. A track wear gauge (JD329-1) is available, enabling the service technician to quickly check the condition of a track assembly.

Use JD329-1 Track Wear Gauge to measure link wear.

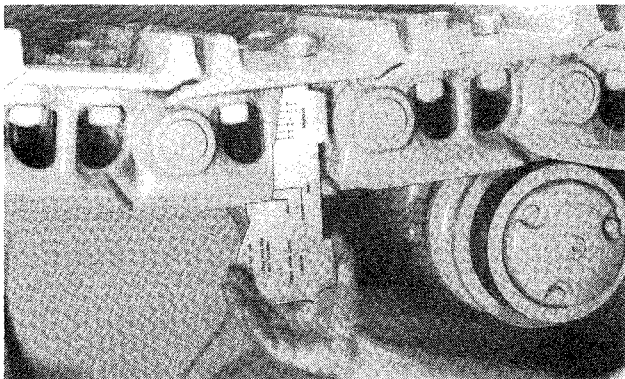

Fig. 87-Link Wear

T78109

Position gauge on track link as shown in Fig. 87. With top of gauge (end with hole) against track shoe, check position of two arrows on gauge in relation to bottom of link. Link is worn if arrow marked "Replace" is at bottom edge of link.

### Bushing Outer Diameter

Measure bushing outer diameter with a D-17524CI (101.6 mm) 4 in. Spring Caliper (part of D-05227ST Undercarriage Inspection Service Tool Kit).

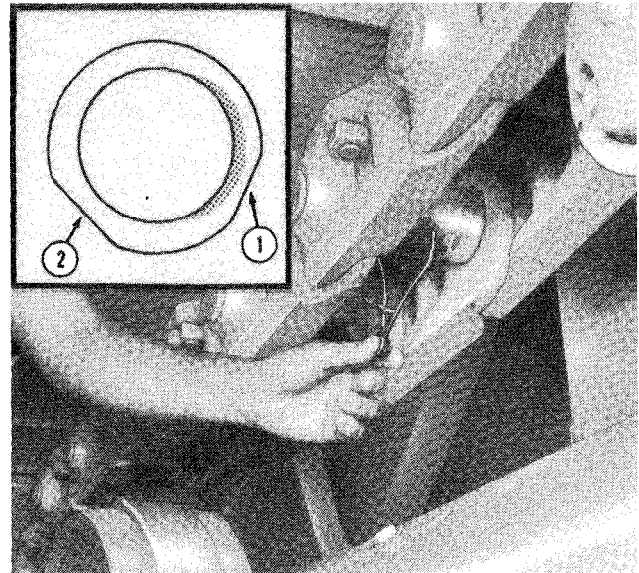

T77888

1—Reverse Drive Wear

2—Forward Drive Side Wear

Fig. 88-Bushing Outer Diameter Measurement

Position a caliper around the bushing as shown in Fig. 88. A bushing wears in two positions, so measure wear by positioning the caliper accordingly. Record the smallest measurement. Repeat the measurement for several bushings.

Outside diameter of a new bushing is (58.8 mm) 2.31 in. Minimum recommended bushing outside diameter is (55.7 mm) 2.19 in. for high shock load conditions and (54 mm) 2.13 in. for normal loading for rotating bushing.

*NOTE:* For additional information on measuring bushing outer diameter refer to UNDERCARRIAGE APPRAISAL MANUAL SP-236.

**<https://www.ebooklibonline.com>**

Hello dear friend!

Thank you very much for reading.

Enter the link into your browser.

The full manual is available for immediate download.

**<https://www.ebooklibonline.com>**