

646B Compactor

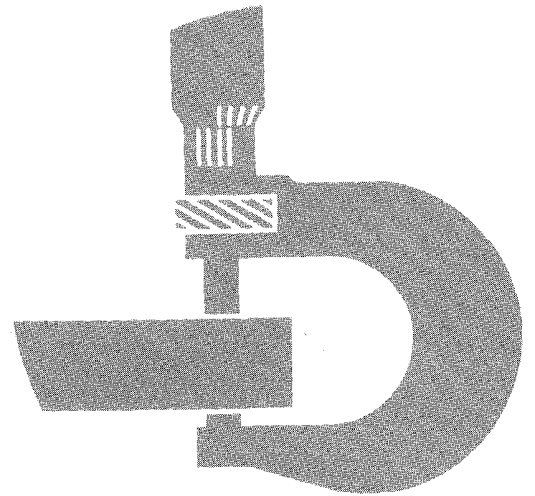

TECHNICAL MANUAL

John Deere Dubuque Works

TM-1116

LITHO IN U.S.A.

SECTION AND GROUP CONTENTS OF THIS MANUAL

SECTION I - GENERAL INFORMATION

- Group I - Contents
- Group II - Introduction and Safety Information
- Group III - General Specifications
- Group IV - Predelivery, Delivery and After-Sale Services
- Group V - Lubrication

SECTION 1 - WHEELS

- Group 0110 - Powered Wheels, Tires and Fastenings
- Group 0199 - Specifications and Special Tools

SECTION 2 - AXLES AND SUSPENSION SYSTEMS

- Group 0201 - Drive Axle Housing and Support
- Group 0210 - Differential or Bevel Drive
- Group 0225 - Input Drive Shafts
- Group 0250 - Axle Shaft, Bearings and Reduction Gears
- Group 0299 - Specifications and Special Tools

SECTION 3 - TRANSMISSION

- Group 0315 - Controls
- Group 0325 - Input Drive Shafts
- Group 0341 - Housings and Covers
- Group 0350 - Gears, Shafts, Bearings and Power Shift Clutch
- Group 0360 - Transmission Hydraulics
- Group 0399 - Specifications and Special Tools

SECTION 4 - ENGINES

- Group 0401 - Crankshaft and Main Bearings
- Group 0402 - Camshafts and Valve Actuating Means
- Group 0403 - Connecting Rods and Pistons
- Group 0404 - Cylinder Block (Liners)
- Group 0407 - Engine Oiling System
- Group 0408 - Ventilating System
- Group 0409 - Cylinder Head and Valves
- Group 0410 - Exhaust Manifold
- Group 0413 - Fuel Injection System
- Group 0414 - Intake Manifold
- Group 0416 - Turbocharger
- Group 0417 - Water Pump
- Group 0418 - Thermostats, Housings and Piping
- Group 0419 - Engine Oil Cooler
- Group 0420 - Fuel Filter
- Group 0421 - Fuel Transfer Pump
- Group 0422 - Starting System
- Group 0433 - Flywheel, Housing and Fasteners
- Group 0499 - Specifications and Special Tools

SECTION 5 - ENGINE AUXILIARY SYSTEMS

- Group 0505 - Cold Weather Starting Aids
- Group 0510 - Engine Cooling Systems
- Group 0520 - Intake System
- Group 0560 - External Fuel Supply Systems
- Group 0599 - Specifications and Special Tools

SECTION 6 - TORQUE CONVERTER

- Group 0641 - Converter Housing and Cover
- Group 0651 - Converter Turbine, Gears, Shafts Etc.
- Group 0699 - Specifications and Special Tools

SECTION 9 - STEERING SYSTEMS

- Group 0960 - Power Steering
- Group 0999 - Specifications and Special Tools

SECTION 10 - SERVICE BRAKES

- Group 1011 - Service Brake Active Elements
- Group 1060 - Brake Hydraulics
- Group 1099 - Specifications and Special Tools

SECTION 11 - PARKING-EMERGENCY BRAKES

- Group 1111 - Parking Brake Active Elements
- Group 1115 - Controls Linkage
- Group 1199 - Specifications and Special Tools

SECTION 16 - ELECTRICAL SYSTEMS

- Group 1671 - Batteries, Support and Cables
- Group 1672 - Alternator, Regulator and Charging System Wiring
- Group 1673 - Vehicle Lighting System
- Group 1674 - Wiring Harness and Switches
- Group 1699 - Specifications and Special Tools

SECTION 17 - FRAME, CHASSIS, OR SUPPORTING STRUCTURE

- Group 1741 - Engine Frame
- Group 1742 - Equipment Frame
- Group 1746 - Bottom Guards
- Group 1749 - Chassis Weights
- Group 1799 - Specifications and Special Tools

SECTION 18 - OPERATOR'S STATION

- Group 1806 - Safety Equipment
- Group 1808 - Comfort and Convenience Items
- Group 1810 - Operator Enclosure
- Group 1821 - Seat
- Group 1823 - Instruments and Indicators
- Group 1824 - External Engine Speed Controls
- Group 1830 - Heater
- Group 1899 - Specifications and Special Tools

SECTION 19 - SHEET METAL

- Group 1910 - Hood or Engine Enclosure
- Group 1921 - Grille and Grille Housing

SECTION 31 - LOADER

- Group 3102 - Buckets
- Group 3115 - Controls Linkage
- Group 3140 - Loader Frames
- Group 3160 - Loader Hydraulics
- Group 3199 - Specifications and Special Tools

SECTION 90 - SYSTEM TESTING

- Group 9005 - General Information - Seven Basic Steps of Testing and Diagnosis
- Group 9010 - Engine
- Group 9015 - Electrical System
- Group 9020 - Power Train
- Group 9025 - Hydraulic System
- Group 9030 - Miscellaneous Components
- Group 9035 - Specifications and Special Tools

II INDEX

<https://www.ebooklibonline.com>

Hello dear friend!

Thank you very much for reading.

Enter the link into your browser.

The full manual is available for immediate download.

<https://www.ebooklibonline.com>



**COMPLETE PAGE LISTING
 WITH LATEST DATE LINES**

I-I-1,2	(Nov-74)	3-0315-1,2	(Jun-80)	4-0401-11,12	(Jun-80)
I-I-3,4	(Nov-74)	3-0315-3,4	(Nov-74)	4-0402-1,2	(Jun-80)
I-I-5,6	(Jun-80)	3-0325-1,2	(Nov-74)	4-0402-3,4	(Jun-80)
I-I-7,8	(Jun-80)	3-0341-1,2	(Jun-80)	4-0402-5,6	(Jun-80)
I-II-1,2	(Nov-74)	3-0341-3,4	(Jun-80)		
I-II-3,4	(Jun-80)	3-0341-5,6	(Jun-80)	4-0403-1,2	(Jun-80)
I-II-5,6	(Jun-80)	3-0341-7,8	(Jun-80)	4-0403-3,4	(Jun-80)
I-II-7,8	(Jun-80)	3-0341-9,10	(Jun-80)	4-0403-5,6	(Jun-80)
I-III-1,2	(Jun-80)	3-0341-11,12	(Jun-80)	4-0403-7,8	(Jun-80)
I-III-3,4	(Jun-80)	3-0341-13,14	(Jun-80)	4-0404-1,2	(Jun-80)
I-IV-1,2	(Dec-78)	3-0341-15,16	(Jun-80)	4-0404-3,4	(Jun-80)
I-IV-3,4	(Dec-78)	3-0350-1,2	(Jun-80)	4-0404-5,6	(Jun-80)
I-IV-5,6	(Dec-78)	3-0350-3,4	(Dec-78)	4-0404-7,8	(Jun-80)
I-IV-7,8	(Dec-78)	3-0350-5,6	(Nov-74)	4-0404-9,10	(Jun-80)
I-IV-9,10	(Dec-78)	3-0350-7,8	(Oct-75)	4-0407-1,2	(Jun-80)
I-IV-11,12	(Dec-78)	3-0350-9,10	(Jun-80)	4-0407-3,4	(Jun-80)
I-IV-13,14	(Jun-80)	3-0350-11,12	(Oct-75)	4-0408-1,2	(Jun-80)
I-IV-15,16	(Dec-78)	3-0350-13,14	(Oct-75)	4-0409-1,2	(Jun-80)
I-IV-17,18	(Jun-80)	3-0350-15,16	(Jun-80)	4-0409-3,4	(Jun-80)
I-IV-19,20	(Dec-78)	3-0350-17,18	(Oct-75)	4-0409-5,6	(Jun-80)
I-IV-21,22	(Dec-78)	3-0350-19,20	(Jun-80)	4-0409-7,8	(Jun-80)
I-IV-23,24	(Dec-78)	3-0350-21,22	(Jun-80)	4-0410-1,2	(Jun-80)
I-IV-25,26	(Dec-78)	3-0350-23,24	(Jun-80)	4-0413-1,2	(Jun-80)
I-IV-27,28	(Dec-78)	3-0350-25,26	(Jun-80)	4-0413-3,4	(Jun-80)
I-IV-29,30	(Dec-78)	3-0350-27,28	(Jun-80)	4-0413-5,6	(Jun-80)
I-V-1,2	(Dec-78)	3-0350-29,30	(Jun-80)	4-0413-7,8	(Jun-80)
I-V-3,4	(Jun-80)	3-0350-31,32	(Jun-80)	4-0413-9,10	(Jun-80)
		3-0350-33,34	(Jun-80)	4-0413-11,12	(Jun-80)
1-0110-1,2	(Jun-80)	3-0350-35,36	(Jun-80)	4-0413-13,14	(Jun-80)
1-0110-3,4	(Jun-80)	3-0350-37,38	(Jun-80)	4-0414-1,2	(Jun-80)
1-0110-5,6	(Jun-80)	3-0350-39,40	(Jun-80)	4-0416-1,2	(Jun-80)
1-0110-7,8	(Jun-80)	3-0360-1,2	(Jun-80)	4-0416-3,4	(Jun-80)
1-0199-1,2	(Nov-74)	3-0360-3,4	(Jun-80)	4-0416-5,6	(Jun-80)
		3-0360-5,6	(Jun-80)	4-0416-7,8	(Jun-80)
2-0201-1,2	(Jun-80)	3-0360-7,8	(Jun-80)	4-0417-1,2	(Jun-80)
2-0201-3,4	(Jun-80)	3-0360-9,10	(Jun-80)	4-0417-3,4	(Jun-80)
2-0201-5,6	(Jun-80)	3-0360-11,12	(Jun-80)	4-0417-5,6	(Jun-80)
2-0210-1,2	(Jun-80)	3-0399-1,2	(Jun-80)	4-0417-7,8*	(Dec-78)
2-0210-3,4	(Jun-80)	3-0399-3,4	(Jun-80)	4-0418-1,2	(Jun-80)
2-0210-5,6	(Jun-80)	3-0399-5,6	(Jun-80)	4-0419-1,2	(Jun-80)
2-0210-7,8	(Jun-80)	3-0399-7,8	(Jun-80)	4-0420-1,2	(Jun-80)
2-0210-9,10	(Jun-80)	3-0399-9,10	(Jun-80)	4-0421-1,2	(Jun-80)
2-0210-11,12	(Jun-80)			4-0422-1,2	(Jun-80)
2-0210-13,14	(Jun-80)	4-0400-1,2	(Jun-80)	4-0422-3,4	(Jun-80)
2-0210-15,16	(Jun-80)	4-0400-3,4	(Jun-80)	4-0422-5,6	(Jun-80)
2-0225-1,2	(Dec-78)	4-0401-1,2	(Jun-80)	4-0422-7,8	(Jun-80)
2-0250-1,2	(Dec-78)	4-0401-3,4	(Jun-80)	4-0422-9,10	(Jun-80)
2-0250-3,4	(Nov-74)	4-0401-5,6	(Jun-80)	4-0422-11,12	(Jun-80)
2-0299-1,2	(Nov-74)	4-0401-7,8	(Jun-80)	4-0422-13,14	(Jun-80)
2-0299-3,4	(Jun-80)	4-0401-9,10	(Jun-80)	4-0422-15,16	(Jun-80)
2-0299-5,6	(Dec-78)				

Vertical lines indicate pages included in this revision.
 *Remove these pages from manual

4-0422-17,18	(Jun-80)	6-0699-3,4	(Jun-80)	16-1671-1,2	(Jun-80)
4-0422-19,20	(Jun-80)	6-0699-5,6	(Jun-80)	16-1671-3,4	(Nov-74)
4-0429-1,2	(Dec-78)	6-0699-7,8	(Jun-80)	16-1671-5,6	(Jun-80)
4-0433-1,2	(Jun-80)	9-0960-1,2	(Mar-77)	16-1671-7,8	(Nov-74)
4-0499-1,2	(Jun-80)	9-0960-3,4	(Nov-74)	16-1672-1,2	(Dec-78)
4-0499-3,4	(Jun-80)	9-0960-5,6	(Jun-80)	16-1672-3,4	(Nov-74)
4-0499-5,6	(Jun-80)	9-0960-7,8	(Jun-80)	16-1672-5,6	(Nov-74)
4-0499-7,8	(Jun-80)	9-0960-9,10	(Jun-80)	16-1672-7,8	(Dec-78)
4-0499-9,10	(Jun-80)	9-0960-11,12	(Mar-77)	16-1672-9,10	(Dec-78)
4-0499-11,12	(Jun-80)	9-0960-13,14	(Oct-75)	16-1672-11,12	(Dec-78)
4-0499-13,14	(Jun-80)	9-0960-15,16	(Nov-74)	16-1672-13,14	(Dec-78)
4-0499-15,16	(Jun-80)	9-0960-17,18	(Nov-74)	16-1672-15,16	(Dec-78)
4-0499-17,18	(Jun-80)	9-0960-19,20	(Oct-75)	16-1672-17,18	(Dec-78)
4-0499-19,20	(Jun-80)	9-0960-21,22	(May-75)	16-1672-19,20	(Dec-78)
4-0499-21,22	(Jun-80)	9-0960-23,24	(Jun-80)	16-1672-21,22	(Dec-78)
4-0499-23,24	(Jun-80)	9-0960-25,26	(Mar-77)	16-1673-1,2	(Oct-75)
4-0499-25,26	(Jun-80)	9-0960-27,28	(Mar-77)	16-1674-1,2	(Jun-80)
4-0499-27,28	(Jun-80)	9-0960-29,30	(Jun-80)	16-1674-3,4	(Jun-80)
4-0499-29,30	(Jun-80)	9-0960-31,32	(Jun-80)	16-1674-5,6	(Jun-80)
4-0499-31,32	(Jun-80)	9-0960-33,34	(Jun-80)	16-1675-1,2	(Dec-78)
4-0499-33,34	(Jun-80)	9-0960-35,36	(Jun-80)	16-1676-1,2	(Jun-80)
4-0499-35,36	(Jun-80)	9-0960-37,38	(Jun-80)	16-1676-3,4	(Jun-80)
4-0499-37,38	(Jun-80)	9-0960-39,40	(Jun-80)	16-1676-5,6	(Jun-80)
4-0499-39,40	(Jun-80)	9-0960-41,42	(Jun-80)	16-1676-7,8	(Jun-80)
4-0499-41,42	(Jun-80)	9-0960-43,44	(Jun-80)	16-1699-1,2	(Dec-78)
5-0505-1,2	(Dec-78)	9-0960-45,46	(Jun-80)	16-1699-3,4	(Jun-80)
5-0505-3,4	(Dec-78)	9-0960-47,48	(Jun-80)	16-1699-5,6	(Jun-80)
5-0505-5,6	(Dec-78)	9-0999-1,2	(Nov-74)	16-1699-7,8	(Jun-80)
5-0510-1,2	(Oct-75)	9-0999-3,4	(Nov-74)	17-1740-1,2	(Jun-80)
5-0515-1,2	(Dec-78)	9-0999-5,6	(Mar-77)	17-1740-3,4	(Jun-80)
5-0520-1,2	(Nov-74)	9-0999-7,8	(Nov-74)	17-1740-5,6	(Jun-80)
5-0560-1,2	(Oct-75)	9-0999-9,10	(Dec-78)	17-1740-7,8	(Jun-80)
5-0599-1,2	(Dec-78)	9-0999-11,12	(Mar-77)	17-1741-1,2*	(Nov-74)
6-0641-1,2	(Jun-80)	9-0999-13,14	(Dec-78)	17-1741-3,4*	(Nov-74)
6-0641-3,4	(Dec-78)	9-0999-15,16	(Jun-80)	17-1741-5,6*	(Nov-74)
6-0641-5,6	(Jun-80)	9-0999-17,18	(Jun-80)	17-1742-1,2*	(Nov-74)
6-0641-7,8	(Jun-80)	9-0999-19,20	(Jun-80)	17-1746-1,2	(Nov-74)
6-0641-9,10	(Jun-80)	10-1011-1,2	(Mar-77)	17-1749-1,2	(Nov-74)
6-0651-1,2	(Jun-80)	10-1011-3,4	(Nov-74)	17-1799-1,2	(Nov-74)
6-0651-3,4	(Jun-80)	10-1060-1,2	(Mar-77)	18-1806-1,2	(Jun-80)
6-0651-5,6	(Jun-80)	10-1060-3,4	(Dec-78)	18-1806-3,4	(Jun-80)
6-0651-7,8	(Nov-74)	10-1060-5,6	(Mar-77)	18-1808-1,2	(Nov-74)
6-0651-9,10	(Nov-74)	10-1060-7,8	(Jun-80)	18-1810-1,2	(Nov-74)
6-0651-11,12	(Jun-80)	10-1060-9,10	(Jun-80)	18-1810-3,4	(Nov-74)
6-0651-13,14	(Jun-80)	10-1099-1,2	(Jun-80)	18-1810-5,6	(Nov-74)
6-0651-15,16	(Jun-80)	10-1099-3,4	(Jun-80)	18-1810-7,8	(Jun-80)
6-0651-17,18	(Jun-80)	11-1111-1,2	(Jun-80)	18-1810-9,10	(Jun-80)
6-0651-19,20	(Jun-80)	11-1111-3,4	(Jun-80)	18-1821-1,2	(Jun-80)
6-0651-21,22	(Jun-80)	11-1111-5,6	(Jun-80)	18-1821-3,4	(Jun-80)
6-0651-23,24	(Jun-80)	11-1115-1,2	(Jun-80)		
6-0651-25,26	(Jun-80)	11-1199-1,2	(Jun-80)		
6-0699-1,2	(Jun-80)				

Vertical lines indicate pages included in this revision.

*Remove these pages from manual.

Litho in U.S.A.

18-1823-1,2*	(Oct-75)	90-9005-1,2	(Dec-78)	90-9025-1,2	(Nov-74)
18-1823-3,4*	(Oct-75)	90-9005-3,4	(Nov-74)	90-9025-3,4	(Mar-77)
18-1823-5,6*	(Nov-74)	90-9010-1,2	(Nov-74)	90-9025-5,6	(Mar-77)
18-1830-1,2	(Dec-78)	90-9010-3,4	(Jun-80)	90-9025-7,8	(Mar-77)
18-1830-3,4	(Jun-80)	90-9010-5,6	(Nov-74)	90-9025-9,10	(Mar-77)
18-1830-5,6	(Jun-80)	90-9010-7,8	(Jun-80)	90-9025-11,12	(Mar-77)
18-1830-7,8	(Jun-80)	90-9010-9,10	(May-75)	90-9025-13,14	(Mar-77)
18-1830-9,10	(Jun-80)	90-9010-11,12	(Jun-80)	90-9025-15,16	(Mar-77)
18-1830-11,12	(Jun-80)	90-9010-13,14	(Jun-80)	90-9025-17,18	(Mar-77)
18-1830-13,14	(Jun-80)	90-9015-1,2	(Jun-80)	90-9025-19,20	(Mar-77)
18-1830-15,16	(Jun-80)	90-9015-3,4	(Dec-78)	90-9025-21,22	(Mar-77)
18-1830-17,18	(Jun-80)	90-9015-5,6	(Dec-78)	90-9025-23,24	(Dec-78)
18-1830-19,20	(Jun-80)	90-9015-7,8	(Jun-80)	90-9025-25,26	(Jun-80)
18-1830-21,22	(Jun-80)	90-9015-9,10	(Dec-78)	90-9025-27,28	(Jun-80)
18-1830-23,24	(Jun-80)	90-9015-11,12	(Jun-80)	90-9025-29,30	(Mar-77)
18-1830-25,26	(Jun-80)	90-9015-13,14	(Jun-80)	90-9025-31,32	(Mar-77)
18-1830-27,28	(Jun-80)	90-9015-15,16	(Jun-80)	90-9025-33,34	(Mar-77)
18-1899-1,2	(Jun-80)	90-9015-17,18	(Jun-80)	90-9025-35,36	(Mar-77)
18-1899-3,4	(Jun-80)	90-9015-19,20	(Jun-80)	90-9025-37,38	(Dec-78)
18-1899-5,6	(Jun-80)	90-9015-21,22	(Jun-80)	90-9025-39,40	(Jun-80)
		90-9015-23,24	(Dec-78)	90-9030-1,2	(Nov-74)
19-1910-1,2	(Nov-74)	90-9015-25,26	(Jun-80)	90-9031-1,2	(Jun-80)
19-1910-3,4	(Nov-74)	90-9015-27,28	(Jun-80)	90-9031-3,4	(Dec-78)
19-1910-5,6	(Nov-74)	90-9015-29,30	(Jun-80)	90-9031-5,6	(Jun-80)
19-1921-1,2	(Nov-74)	90-9015-31,32	(Jun-80)	90-9031-7,8	(Jun-80)
		90-9015-33,34	(Dec-78)	90-9031-9,10	(Jun-80)
31-3102-1,2	(Jun-80)	90-9015-35,36	(Dec-78)	90-9031-11,12	(Jun-80)
31-3102-3,4	(Nov-74)	90-9015-37,38	(Dec-78)	90-9031-13,14	(Jun-80)
31-3102-5,6	(Nov-74)	90-9015-39,40	(Dec-78)	90-9031-15,16	(Jun-80)
31-3102-7,8	(Jun-80)	90-9015-41,42	(Jun-80)	90-9031-17,18	(Jun-80)
31-3115-1,2	(Jun-80)	90-9015-43,44	(Jun-80)	90-9031-19,20	(Jun-80)
31-3140-1,2	(Jun-80)	90-9015-45,46	(Dec-78)	90-9035-1,2	(Jun-80)
31-3160-1,2	(Nov-74)	90-9015-47,48	(Dec-78)	90-9035-3,4	(Jun-80)
31-3160-3,4	(Nov-74)	90-9015-49,50	(Dec-78)	90-9035-5,6	(Jun-80)
31-3160-5,6	(Nov-74)	90-9015-51,52	(Dec-78)	90-9035-7,8	(Dec-78)
31-3160-7,8	(Dec-78)	90-9020-1,2	(Nov-74)	90-9035-9,10	(Dec-78)
31-3160-9,10	(Dec-78)	90-9020-3,4	(Nov-74)	90-9035-11,12	(Jun-80)
31-3160-11,12	(Jun-80)	90-9020-5,6	(Nov-74)	90-9035-13,14	(Dec-78)
31-3160-13,14	(Jun-80)	90-9020-7,8	(Nov-74)	90-9035-15,16	(Dec-78)
31-3160-15,16	(Jun-80)	90-9020-9,10	(Jun-80)	90-9035-17,18	(Jun-80)
31-3160-17,18	(Jun-80)	90-9020-11,12	(Oct-75)		
31-3160-19,20	(Jun-80)			Index 1,2	(Jun-80)
31-3160-21,22	(Jun-80)			Index 3,4	(Jun-80)
31-3160-23,24	(Jun-80)			Index 5,6*	(Dec-78)
31-3160-25,26	(Jun-80)			Index 7,8*	(Dec-78)
31-3160-27,28	(Jun-80)				
31-3199-1,2	(Jun-80)				
31-3199-3,4	(Nov-74)				
31-3199-5,6	(Nov-74)				
31-3199-7,8	(Jun-80)				

Vertical lines indicate pages included in this revision.
 *Remove these pages from manual.



Group II INTRODUCTION AND SAFETY INFORMATION INTRODUCTION

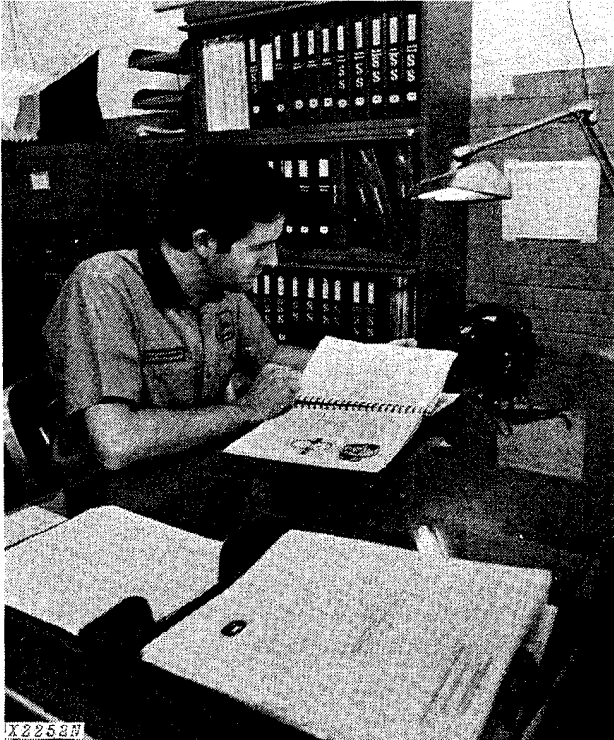

Use FOS Manuals for Reference

This technical manual is part of a twin concept of service:

The two kinds of manuals work as a team to give you both the general background and technical details of shop service.

•FOS Manuals—for reference

Fundamentals of Service (FOS) Manuals cover basic theory of operation, *fundamentals* of trouble shooting, *general* maintenance, and *basic* types of failures and their causes. FOS Manuals are for training new men and for reference by experienced men.



When a serviceman should refer to a FOS Manual for more information, a FOS symbol like the one at the left is used in the TM to identify the reference.

•Technical Manuals—for actual service

Technical Manuals are concise service guides for a *specific* machine. Technical manuals are on-the-job guides containing only the vital information needed by a journeyman mechanic.

Litho in U.S.A.



Use Technical Manuals for Actual Service

This technical manual was planned and written for you—a journeyman mechanic. Keep it in a permanent binder in the shop where it is handy. Refer to it whenever in doubt about correct service procedures or specifications.

Some features of this manual:

- Inside front cover - "Table of Contents".
- Section I - Contents, safety information, general specifications and general services.
- Sections 1 through 42 - Removal, repair, testing (components removed), installation, and adjustment.
- Section 90 - Detailed explanation of system operation, diagnosis, visual inspection, testing, and adjustments.
- Specifications grouped and illustrated at the end of each section.

MAINTENANCE WITHOUT ACCIDENT WORK SAFELY



T27999

 This safety alert symbol identifies important safety messages in this manual and on the compactor. When you see this symbol, be alert to the possibility of personal injury and carefully read the message that follows.

**EVERY EMPLOYER HAS A
SAFETY PROGRAM. KNOW
WHAT IT IS!**



T27501N

Consult your shop foreman for specific instructions on a job, and the safety equipment required.

For instance, you may need: Hard hat, safety shoes, safety goggles, heavy gloves, reflector vests, ear protectors, respirators.

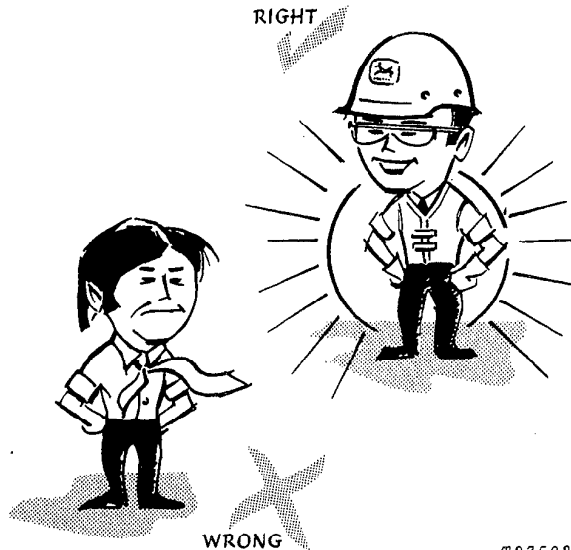

T27502N

ALWAYS AVOID loose clothing or any accessory—flopping cuffs, dangling neckties and scarves, or rings and wrist watches—that can catch in moving parts and put you out of work.

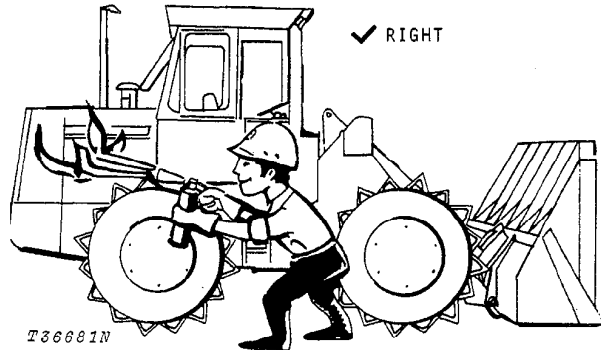

T36681N

BE ALERT!

Plan ahead — work safely — avoid accidental damage and injury. If a careless moment does cause an accident or fire, react quickly with the tools and skills at hand — know how to use a first aid kit and a fire extinguisher — and where to get aid and assistance. In an emergency, split-second action is the key to safety.

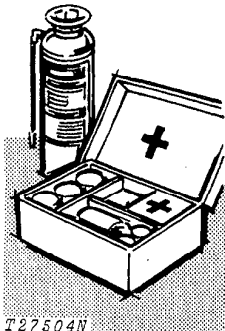

T27504N

MAINTENANCE WITHOUT ACCIDENT

Specific safety procedures should always be observed, whether servicing the equipment or making the repairs. Remembering these—in time!—can prevent an injury...or save your life....

AVOID FIRE HAZARDS—

Fuel Is Dangerous!

- Don't smoke while refueling.
- Don't smoke while handling highly flammable material.
- Engine should be shut off when refueling.
- Use care in refueling if the engine is hot.

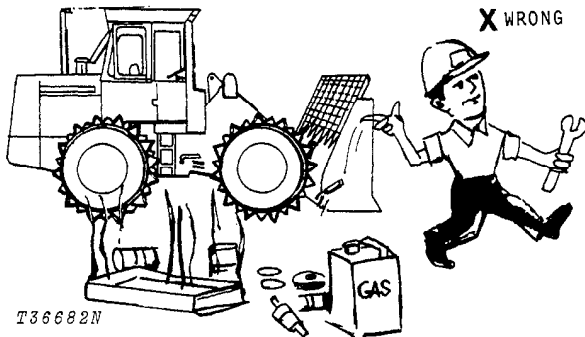

Don't use open pans of gasoline or diesel fuel for cleaning parts. Good commercial, nonflammable solvents are preferred.

Battery Gas Is Highly Flammable!

Provide adequate ventilation when charging batteries.

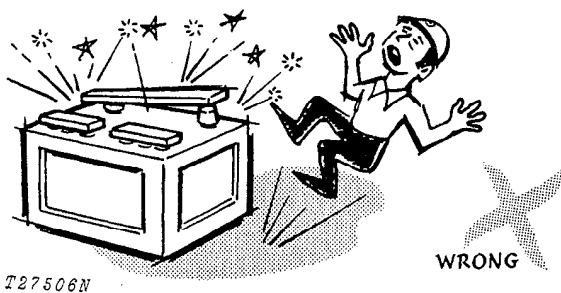

- Don't check battery charge by placing metal objects across the posts.
- Don't allow sparks or open flame near batteries.
- Don't smoke near battery.

Know Where Fire Extinguishers Are Kept!

Flame Is Not a Flashlight!

Never check fuel, battery electrolyte or coolant levels with an open flame.

Never use an open flame to look for leaks anywhere on the equipment.

Never use an open flame as a light anywhere on or around the equipment.

UNDER ALL MAINTENANCE CONDITIONS—

Do not perform any work on the equipment unless authorized to do so. Then be sure you know what you're doing. Follow recommended procedures.

Never service the equipment while it is being operated.

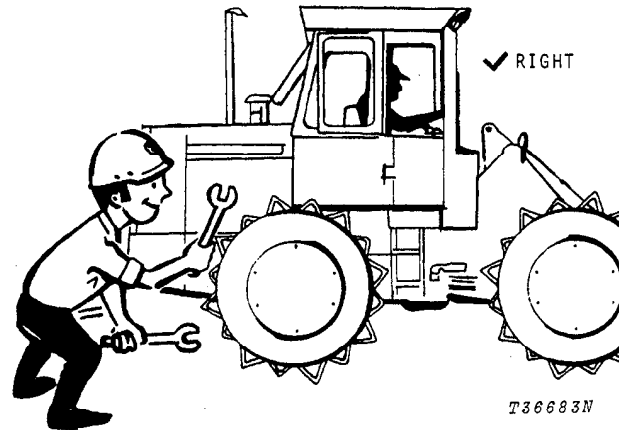

Avoid working on equipment with the engine running. If it is necessary to make checks with the engine running, **ALWAYS USE TWO SERVICE TECHNICIANS**—one, the operator, at the controls, the other checking within sight of the operator. Also, put the transmission in neutral, set the parking brake, and apply any safety locks provided. **KEEP HANDS AWAY FROM MOVING PARTS.**

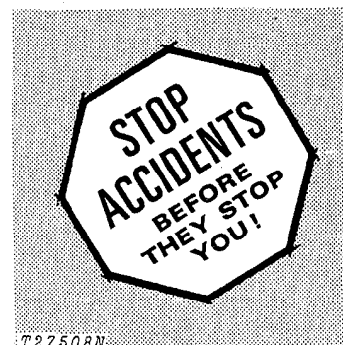

MAINTENANCE WITHOUT ACCIDENT

Before servicing, adjusting, or repairing compactors—**LOWER** attachments to the ground—or, if necessary to raise them for access to certain parts, **SECURELY SUPPORT** by external means. **DO NOT** rely on controls to support or position attachments for maintenance.

Never allow **ANYONE** to walk under equipment that is raised and not properly blocked.

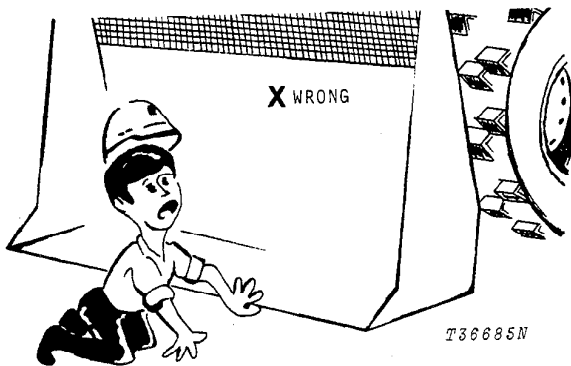

Avoid working directly under raised and blocked equipment unless absolutely necessary.

If the machine is on an incline, block it securely.

Use hoisting equipment for lifting heavy parts. **TAKE CARE! WATCH OUT FOR OTHER PEOPLE IN THE VICINITY.**

Use extreme caution in removing radiator caps, drain plugs, grease fittings, or hydraulic pressure caps.

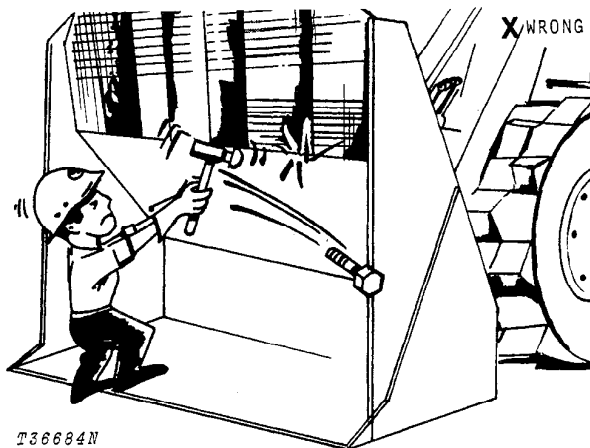

Wear safety glasses when drilling, grinding, or hammering metal.

Make sure the maintenance area is adequately vented.

Keep maintenance area **CLEAN AND DRY**. Oily and wet floors are slippery; greasy rags are a fire hazard; wet spots are dangerous when working with electrical equipment.

Store starting aids in a cool and well-ventilated place, out of the reach of unauthorized personnel.

SERVICING PRECAUTIONS

Stop the engine before cleaning or lubricating the equipment.

Lower mounted equipment and tools to the ground carefully.

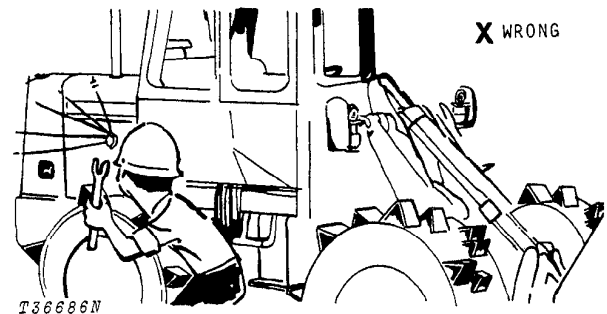

Engine coolant gets hot! Don't remove the radiator cap until coolant temperature is below the boiling point. Then turn cap slightly to relieve pressure before removing.

Exhaust gases are dangerous! Periodically check exhaust system for excessive leakage.

Don't forget a hydraulic system may be pressurized! To relieve pressure, stop engine and lower boom. Operate steering wheel, brake pedals and control levers until system fails to respond.

The compactor is equipped with hydraulic accumulators—recharge by using only dry nitrogen. See page 0960-46 or 1060-10.

When checking hydraulic pressure, be sure to use the correct test gauge for the pressure in the particular system.

MAINTENANCE WITHOUT ACCIDENT

RIGHT ✓

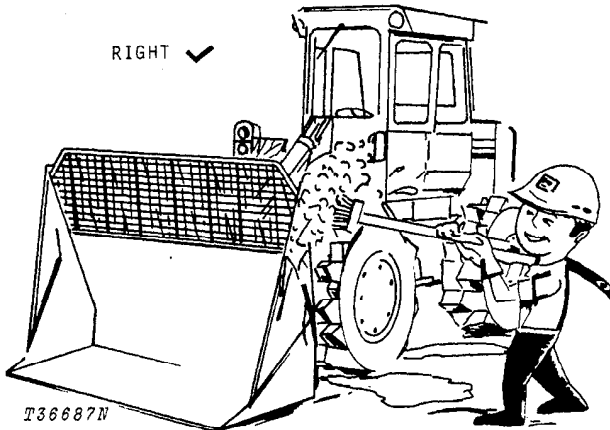

Keep ALL equipment free of dirt and oil. This attention will minimize fire hazards and facilitate spotting of loose or defective parts.

When preparing engine for storage, remember that inhibitor is volatile and therefore dangerous. Seal and tape openings after adding the inhibitor. Keep container tightly closed when not in use.

ADJUSTING PRECAUTIONS

.... for Operating Adjustments

Keep clutch and brake control units properly adjusted at all times. Before making adjustments, stop engine.

✗ WRONG



T32708N

Before removing any housing covers, stop engine. Take all objects from your pockets which could fall into the opened housings. Don't let adjusting wrenches fall into opened housings.

.... for Maintenance Adjustments

Don't adjust the fuel system while the machine is in motion.

✗ WRONG



T32709N

Don't attempt to check belt tension while the engine is running.

MAINTENANCE WITHOUT ACCIDENT

PRECAUTIONS DURING REPAIR

Before working on hydraulic systems—make sure engine is not running and the system pressure is relieved by working the control levers, steering wheel and brakes in all directions with the engine shut off.

Before repairing the electrical system, or performing a major overhaul, make sure the batteries are disconnected.

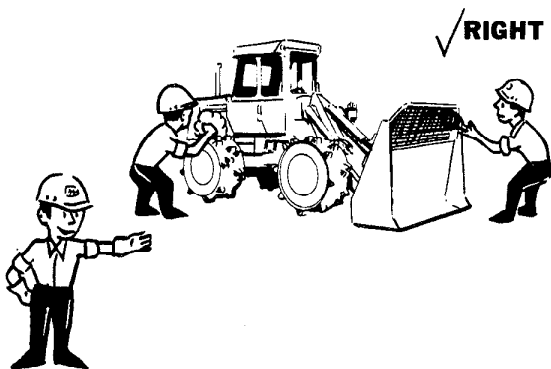

T36688N

Keep all equipment free of dirt and oil. This attention will minimize fire hazards and facilitate spotting of loose or defective parts.

When changing cutting edges on bucket—
Stop the engine and securely block the bucket.

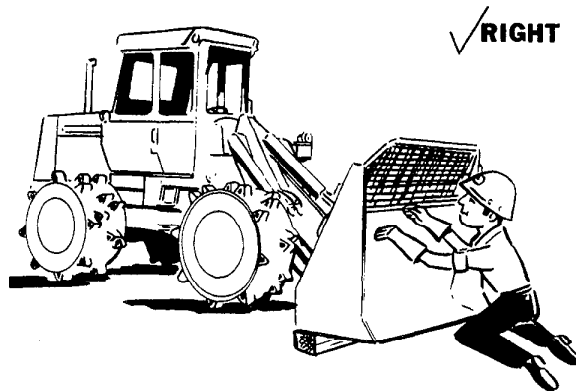

T36689N

Never let your bare hands come in contact with the sharp edges. WEAR GLOVES.

MAINTENANCE WITHOUT ACCIDENT

KNOW EQUIPMENT IS READY!

Check guards, canopies, safety bars—all protective devices installed on the compactor. Every one should be in place and secure.

CHECK IT OUT!

- GUARDS
- CANOPIES
- SHIELDS
- PROTECTIVE DEVICES
- ROLL-OVER PROTECTIVE STRUCTURES
- SEAT BELTS, ETC.

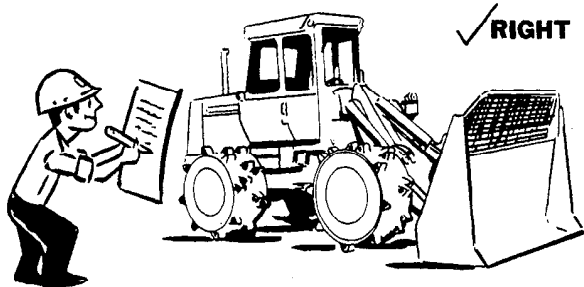

T36690N

Carefully inspect equipment for visual defects—leaks in fuel, lubrication, and hydraulic systems. Do not search for pressurized fluid leaks with your hands. Use cardboard or wood to search for leaks.

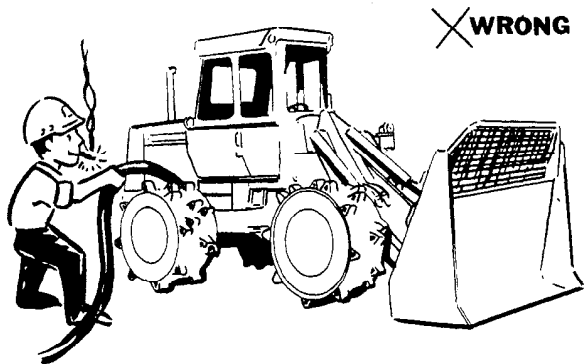

T36691N

Check levels of fuel, coolant, hydraulic fluid, and lubricating oil. If fuel must be added—**FIRST, PUT OUT THAT CIGARET.**

Check and secure all caps and filler plugs for fuel, oils, radiator, etc.

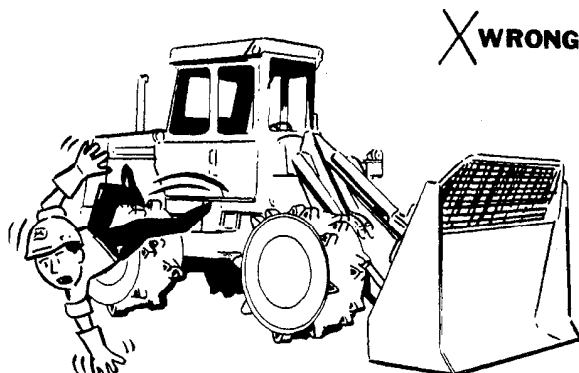

T36692N

Be sure to clean any oil, grease or mud accumulation from floor of operator's compartment, stepping points, and grab rails to minimize the danger of slipping.

In freezing weather beware of snow or ice deposits on stepping points, grab rails, and floor.

Remove loose bolts, tools, or other objects from floor of operator's compartment.

Although it is impractical to try to cover every possible maintenance situation, the safety precautions recommended here should serve to develop and promote safe maintenance procedures.

The information contained in this manual is not intended to replace safety codes, insurance requirements, federal, state, and local laws, rules and regulations. In particular, your service area or jobsite activities may be subject to state safety rules and/or federal regulation under the Occupational Safety and Health Act (OSHA). Familiarize yourself with all regulations applicable to your situation in order to avoid possible safety violations.

Illustrations and copy reproduced in part by permission of Construction Industry Manufacturers' Association (CIMA).



Group III

GENERAL SPECIFICATIONS

Power (at 2,200 engine rpm):	SAE	DIN
Gross	160 hp (119.3 kW**)	
Net	145 hp (108.1 kW**)	147.5 PS

*Net engine flywheel power is for an engine equipped with fan, air cleaner, water pump, lubricating oil pump, fuel pump, alternator, and muffler. The gross engine power is without fan. Flywheel power ratings are under SAE standard conditions of 500-ft (152 m) altitude and 85°F (29.4°C) temperature and DIN 70 020 (non-corrected). No derating is required up to 10,000 ft. (3000 m) altitude.

**In the international system of units, power is expressed in Kilowatts (kW).

Engine: John Deere turbocharged diesel, vertical 6-cylinder, valve-in-head, 4-stroke cycle.	
Bore and stroke	4.75 x 5 in. (120.5 mm x 127 mm)
Piston displacement	531 cu. in. (8702 cm ³)
Compression ratio	15.8 to 1
Maximum torque @ 1500 rpm	432 lb-ft (59.7 kg-m)
NACC or AMA (U.S. Tax) horsepower	54.0
Lubrication	Pressure system with full-flow filter
Cooling	Pressurized with thermostat and controlled bypass
Fan	Suction
Air cleaner w/restriction indicator	Dry
Electrical system	12 volt (12-V) w/alternator
Batteries (2)	Reserve capacity: 310 minutes each battery

Torque Converter:	
Type	Twin-turbine
Torque multiplication	3.34 to 1
Transmission	Power Shift planetary

Recommended Travel Speeds	
Forward and reverse	4.5 mph (7.2 km/h) maximum

Differentials:	
Front	No-Spin
Rear	Standard

Drive Axles ... Inboard-mounted planetary gears to each wheel. Front axle fixed. Rear axle oscillates 22-degree total. 15.8 inches (401 mm) vertical travel at center of tire.

Brakes:	
Service	Power actuated, 4-wheel, inboard-mounted wet disk. Foot-operated by either right or left pedal.
Parking	10 x 1.5 inch (254 mm x 38 mm) expanding shoe on transmission output shaft. Adjustable, hand operated with warning light on dash.

Steering Full power steering. Frame articulated 80 degrees by two hydraulic cylinders. Turning radius of 15 feet 6.7 inches (4.74 m). Turning clearance is 36 ft 10.8 inches (11.25 m).

Hydraulic Systems:	
Loader functions	independent engine driven, vane pump delivers 44.5 gpm (168.4 L/min) at 600 psi (42.2 kg/cm ²) and 2,200 engine rpm.
	2,250 psi (158.2 kg/cm ²) relief valve pressure setting.
Control	Two lever triple hydraulic valve for use with refuse bucket or special multipurpose bucket.
Steering and brakes	Engine-driven, eight-piston, variable-displacement pump delivers 26 gpm (98.4 L/min) at 2,200 engine rpm and 2,000 psi (140.6 kg/cm ²). Maximum system pressure is 2,400 psi (168.7 kg/cm ²)

Compactor Wheels (Cepeco):	
Width	23 in. (584 mm)
Diameter	56.75 in. (1 442 mm)
60° cleats, 32/wheel	5 in. (127 mm)
Encased General tires	13-24, 12 ply L-G
Compaction	Up to 3,223 psi (226.6 kg/cm ²)

Compactor Wheels (Caron):	
Width	23 in. (584 mm)
Diameter	60 in. (1 524 mm)
20 tractor cleats	5.5 in. (140 mm) long @ tip
10 contour cleats	3 in. (76 mm) long @ tip
Compaction	Up to 3640 psi (25 097 kPa)

Landfill Buckets:

	Capacity	Width
Refuse Dirt:	2-3/4 cu. yd. (2.1 m ³)	110.8 in. (2.81 m)
. Refuse:	4-1/2 cu. yd. (3.44 m ³)	
Light materials	4-1/2 cu. yd. (3.44 m ³)	110.7 in. (2.81 m)
Multipurpose Dirt:	2-1/2 cu. yd. (1.91 m ³)	104.75 in. (2.66 m)
. Refuse:	3-3/4 cu. yd. (2.87 m ³)	

Wheel Treads:

Front and rear	81.5 in. (2.07 m)
Width outside wheels	104.5 in. (2.65 m)

Capacities:

	U.S.	Litres
Cooling system	49 qt.	46.4
Fuel tank	56 gal.	211.9
Crankcase	20 qt.	18.9
Crankcase, includes filter	22 qt.	20.8
Transmission case and filters	39 qt.	36.9
Front differential	24 qt.	22.7
Rear differential	25 qt.	23.7
Hydraulic sump	70 qt.	66.2

Special Equipment:

- Refuse bucket
- Multipurpose landfill bucket
- Light-materials bucket
- Reverse warning system switch
- Automatic boom height control
- 3-inch seat belt
- Multipurpose bucket teeth
- Suspension seat
- ROPS quiet cab
- Air conditioning
- Side weights
- Muffler
- Reverse warning alarm

Additional Standard Equipment:

- Adjustable cushioned seat
- Engine side shields
- Key switch
- Push button safety start
- Cigar lighter
- Parking brake
- Vandal protection
- Horn
- Lights
- Working lights
- Fixed drawbar
- Vertical exhaust w/rain cap
- Hand grips
- ROPS with cab and seat belt
- Cab heater
- Cold weather starting aid
- Radiator guard and screen
- Fire extinguisher
- Electric hour meter
- Defroster fan
- Front and rear windshield wipers
- Instrument panel cover with locks
- Park brake warning buzzer
with light
- Precleaner

SAE Operating Weight

	lb.	kg
(with Cepeco wheels):		
With refuse bucket	31,450 lb.	(14,266 kg)
With multi-purpose bucket	32,230 lb.	(14,620 kg)

SAE Operating Weight (with Caron wheels):

With refuse bucket	31,986 lb.	(14,508 kg)
With multi-purpose bucket	32,766 lb.	(14,862 kg)

DIMENSIONS

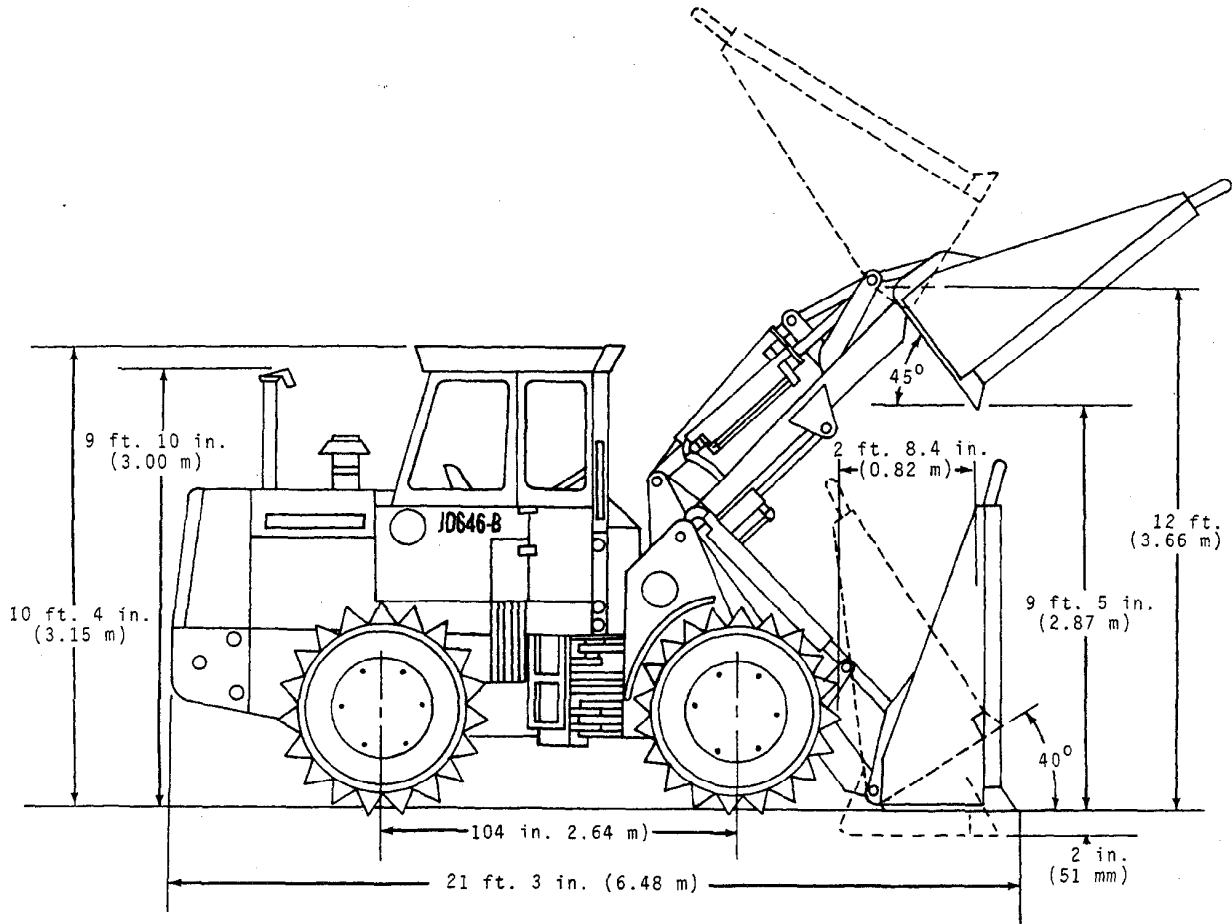

T36693N

(Specifications and design are subject to change without notice. Wherever applicable, specifications are in accordance with ICED and SAE Standards. Except where otherwise noted, specifications are based on a machine equipped with standard equipment, refuse bucket, Cepeco wheels, full fuel tank and 175 lb. (79.4 kg) operator.)



Group IV PREDELIVERY, DELIVERY, AND AFTER-SALE SERVICES

TEMPORARY STORAGE

After receiving your compactor from the factory and before putting the machine into temporary storage perform the following checks.

For long term storage (over 30 days) information, consult your JD646-B Operator's Manual.

1. Check battery electrolyte level and charge the battery, if necessary.
2. Check the level of coolant in the radiator. The coolant should be maintained at a level midway between the radiator core and filler neck.
3. Fill the fuel tank.
4. Check crankcase oil level. Oil should be at top mark of dipstick after machine has been shut down for ten minutes.
5. Relieve hydraulic pressure by stopping engine, lowering boom and operating steering wheel or control levers until system fails to respond.

PREDELIVERY SERVICE

Because of the shipping factors involved, plus extra finishing touches that are necessary to promote customer satisfaction, proper predelivery service is of prime importance to the dealer and the customer.

If adjustments are required, procedures are found in the After-Sale section.

Use the following check list when preparing a compactor for delivery to the customer.

1. Pre-cleaner

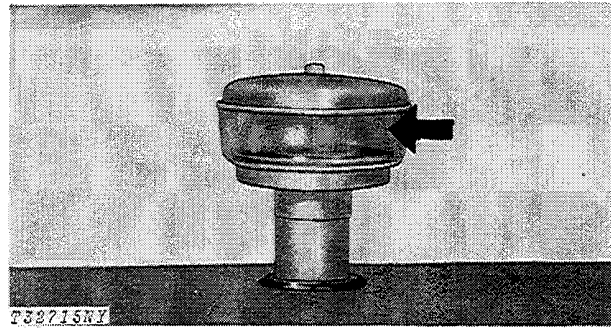

Fig. 1-Pre-cleaner

Check and clean pre-cleaner bowl.

Pre-cleaner checked and cleaned

Yes No

2. Air Cleaner

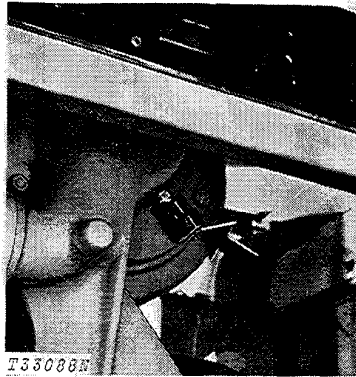
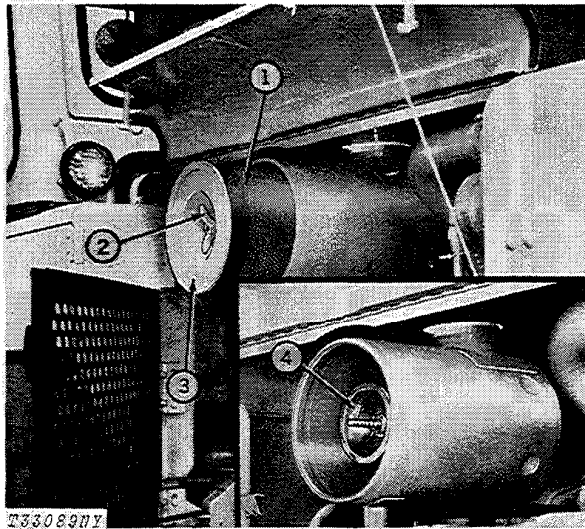

Fig. 2-Air Cleaner Restriction Indicator

Check air filter air restriction indicator. If the indicator shows red, check and clean primary air filter element. Replace both primary and safety filter elements, if necessary.



- 1—Primary Filter Element
- 2—Wing Nut
- 3—Air Cleaner Cover
- 4—Safety Filter Element

Fig. 3-Air Cleaner

Air cleaner checked	Yes	No
Filters replaced	Yes	No

3. Fuel Filters

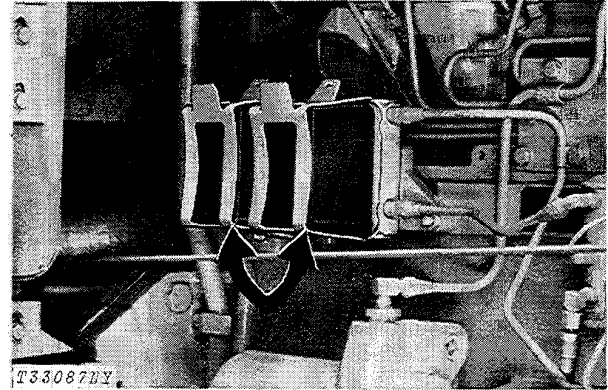

Fig. 4-Fuel Filters

Check fuel filters and drain any sediment that is present.

Sediment present in filter	Yes	No
----------------------------	-----	----

4. Air Intake Hoses

Check air intake hoses for loose or improper connections. Check air cleaner to exhaust stack aspirator hose for restrictions, damage or loose connections.

Hoses checked	Yes	No
---------------	-----	----

5. Batteries

Check battery electrolyte level. Batteries are located to the left of the operator and are accessible through the top door in the battery compartment. If distilled water is not available, use clean soft water. Avoid use of hard water. Remove foreign material from top of battery and coat terminals with petroleum jelly. Check vent holes in battery caps.

IMPORTANT: Never add water to battery in freezing weather unless engine is to be run two or three hours to assure mixing of water and electrolyte.

Punch date code on battery.

Water added	Yes	No
-------------	-----	----

9. Hydraulic Oil Level

Check compactor hydraulic system oil level.

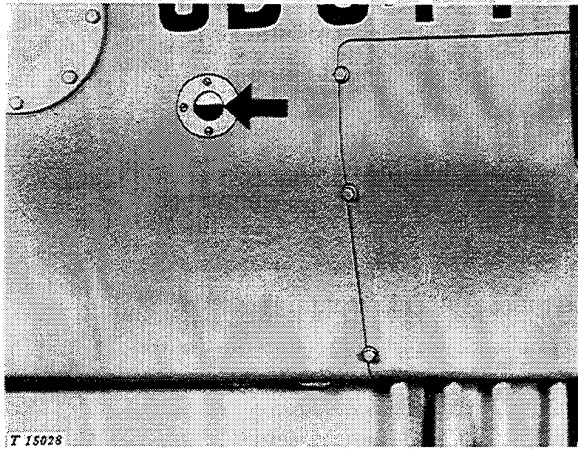

Fig. 8-Compactor Hydraulic System Window Indicator

Check compactor hydraulic system oil level with bucket resting on the ground. The oil level should be half way up the window on the reservoir. If oil is low, add enough John Deere HY-GARD or equivalent to bring level up to this point. The filler opening is located under the lid on top of the reservoir. Prevent dirt from entering system. Do not overfill.

Hydraulic system oil level checked Yes No
 Oil added, if any _____ qts (L)

10. Transmission Oil Level

Check transmission oil level.

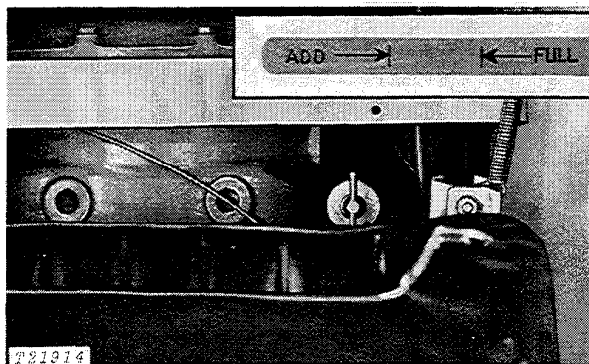

Fig. 9-Transmission Dipstick

A dipstick, located on the left side of the transmission, is accessible by tilting the back of the seat forward. The correct oil level check is made with the dipstick fully inserted in dipstick tube.

Perform both of the following transmission oil level checks: (a) Before starting the engine check the oil level with dipstick. If the oil level is at or near the upper (FULL) mark, there is sufficient oil in the system to permit starting the engine. If oil level is low add John Deere Torque-Converter Fluid (Type C-3) or an equivalent. Replace dipstick and tighten finger tight.

(b) Operate compactor until the transmission reaches normal operating temperature. Idle the engine and shift through all ranges slowly. This will fill all parts in the system with oil. Shift to neutral, apply the brakes and allow engine to idle. Check oil level again. It should now be at or above the lower (ADD) mark and not above the upper (FULL) mark on the dipstick. If not, add oil. Do not overfill.

Transmission oil level checked Yes No
 Oil added, if any _____ qts (L)

11. Front and Rear Differential Oil Level

Check front and rear differential oil level.

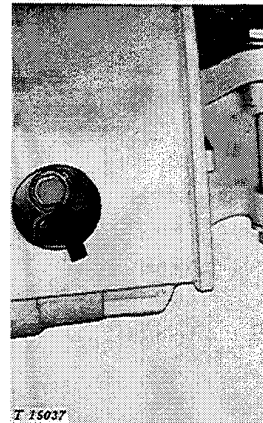

Fig. 10-Front Differential Check Plug

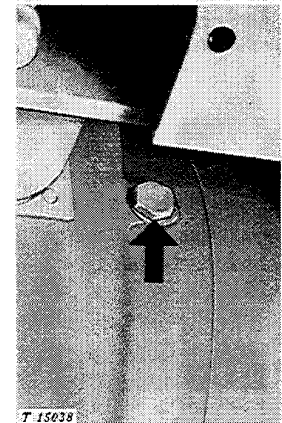

Fig. 11-Rear Differential Check Plug

Check oil level at oil level - filler plug on the side of the differential housings. Oil must be cold and compactor must be on level ground. The oil level should be up to the plug. Add John Deere HY-GARD Oil or an equivalent, if necessary.

Differential oil levels checked Yes No
 Oil added, if any _____ qts. (L)

12. Alternator-Fan Belt Tension

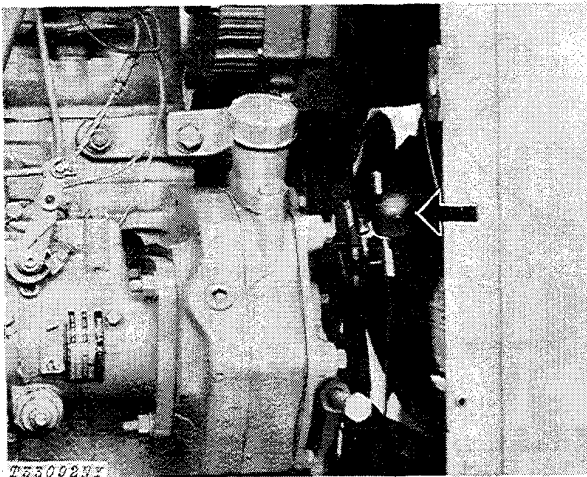

Fig. 12-Alternator Belt Tension

Alternator Belt Tension

Check alternator belt tension using a belt tension gauge. A force of 17 pounds (76 N) on the alternator belt midway between the pulleys should deflect the belt 1/4 inch (6.4 mm).

IMPORTANT: Apply outward force to **FRONT** of alternator housing only.

To adjust, loosen alternator bracket and adjusting cap screws. Apply outward pressure to the front alternator frame. Adjust to desired tension. Tighten adjusting cap screws on alternator bracket.

When a strand tension gauge is used, the initial reading should be 130 to 140 pounds (579 to 623 N) strand tension. After 3 minutes of operation recheck belt tension. The gauge should read a minimum of 85 to 95 pounds (378 to 423 N) strand tension.

NOTE: Recheck belt tension after adjustment. **DO NOT OVERTIGHTEN.**

Fan Belt Tension

Check fan belt tension using a belt tension gauge. A force of 20 pounds (89 N) on the fan belts midway between the pulleys should deflect the belts 0.75 inch (19 mm).

To adjust, turn the idler pulley adjusting screw to adjust tension on idler pulley. Tighten idler pulley adjusting screw.

When a strand tension gauge is used, the initial reading should be 95 to 105 pounds (423 to 467 N) strand tension. After 3 minutes of operation recheck belt tension. The gauge should read a minimum of 85 to 95 pounds (378 to 422 N) strand tension.

NOTE: Recheck belt tension after adjustment. **DO NOT OVERTIGHTEN.**

Alternator belt checked	_____ lb. (kg) tension
	_____ in. (mm) flex
Fan belt checked	_____ lb. (kg) tension
	_____ in. (mm) flex

13. Engine Speeds

Warm up engine and attach a tachometer to the engine tachometer drive to check engine speeds.

No-load, fast idle speed should be 2400 rpm. Slow idle should be 700 rpm.

If engine speeds need adjustment, see page I-IV-24.

Engine speeds checked	Yes	No
-----------------------	-----	----

14. Grease Fittings

The compactor was checked and lubricated before it left the factory. However, to insure customer satisfaction, check each lubrication point on the following pages. Lubricate with several strokes, if necessary.

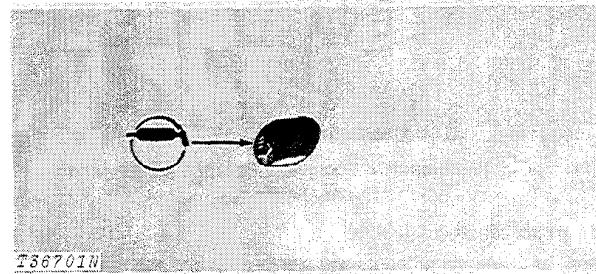

Fig. 13-Steering Cylinder Rear Pivot Pins (2 Points)

Lubricant required	Yes	No
--------------------	-----	----

Lubricate all pivot points in the linkage from the boom and bucket control lever to the control valves with engine oil.

Lubricant required	Yes	No
--------------------	-----	----

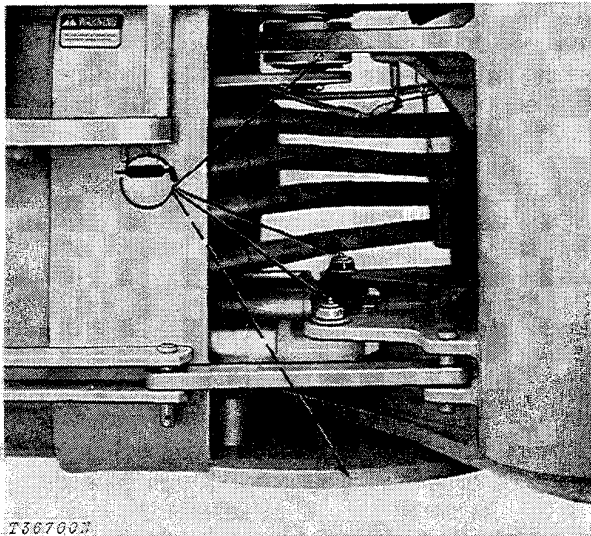

Fig. 14-Steering Cylinder Front Pivots Pins (2 Points)
and Frame Hinge Pivots (2 Points)

Lubricant required Yes No

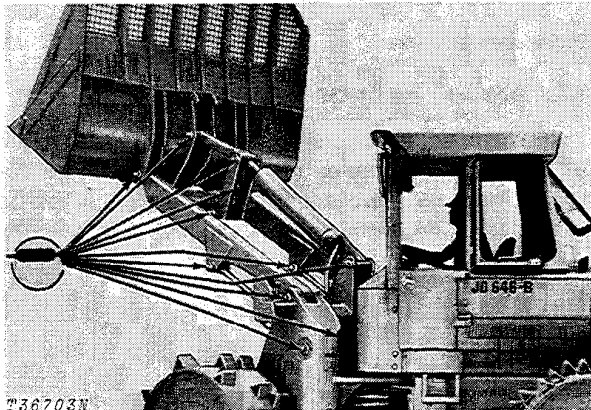

Fig. 15-Compactor Boom and Bucket Cylinders and
Pivots (14 Points)

Lubricant required Yes No

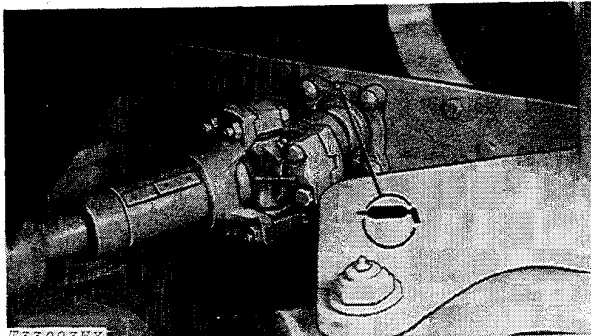

Fig. 16-Front Drive Shaft Support Bearing (1 Point)

Lubricant required Yes No

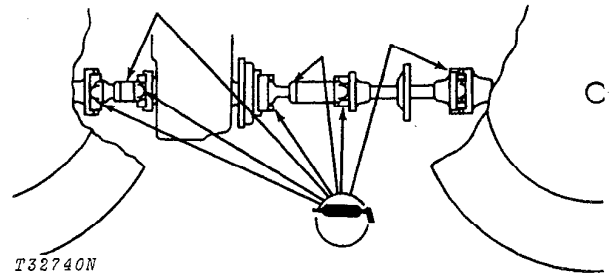

Fig. 17-Transmission-to-Differential
Drive Lines (7 Points)

Lubricant required Yes No

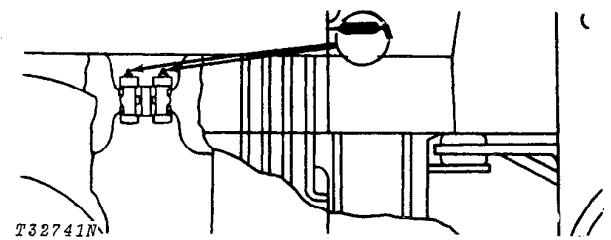

Fig. 18-Engine-to-Transmission
Universal Joint (2 Points)

Lubricant required Yes No

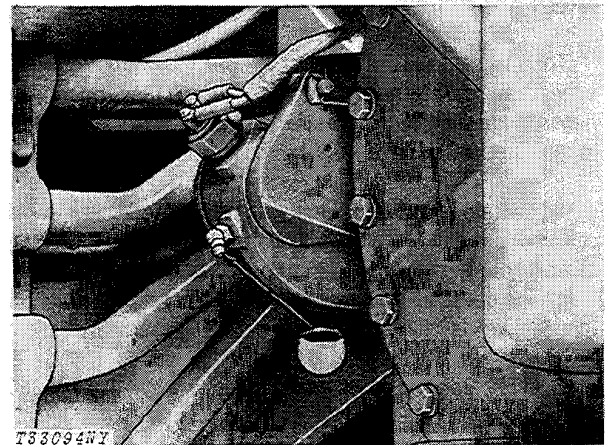

Fig. 19-Shift Control Bell Crank Fitting (1 Point)

Lubricant required Yes No

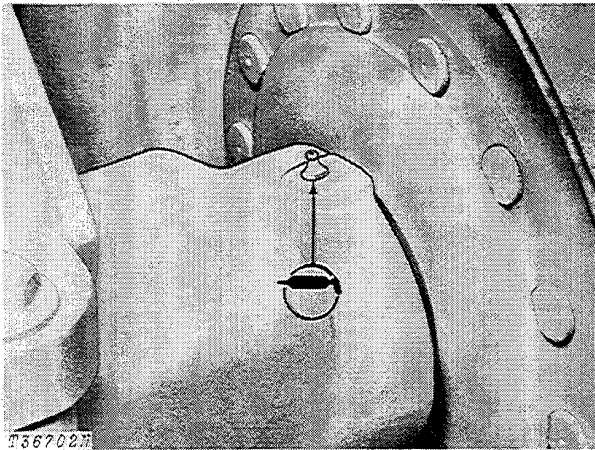

Fig. 20-Axle Bearing Grease Fitting (Front Shown) (4 Points)

Lubricant required Yes No

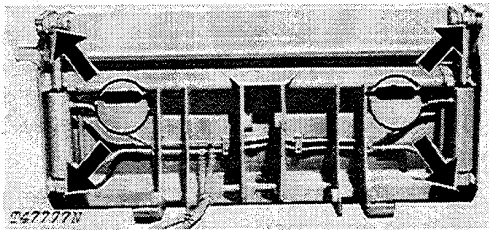
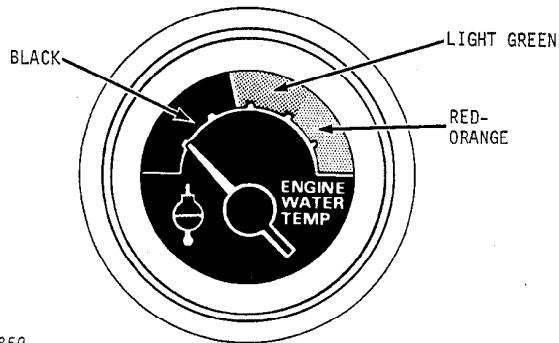

Fig. 21-Multi-Purpose Bucket Pivots (4 Points)

Lubricant required Yes No

15. Indicator Lights and Gauges

When operating the compactor, check the following gauges for correct operation.



T50859

Fig. 22-Engine Coolant Temperature Gauge

Normal operating range is indicated by the light green area on the gauge face—135°F to 224°F (57°C to 107°C).

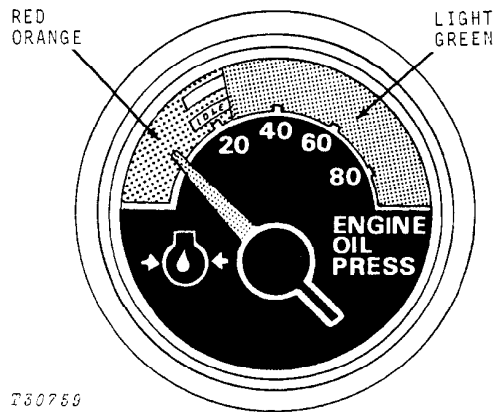

T30759

Fig. 23-Engine Oil Pressure Gauge

Normal operating range is indicated by the green zone on the gauge face.

If engine oil pressure indicator hand is not in the green zone, stop engine and check oil level.

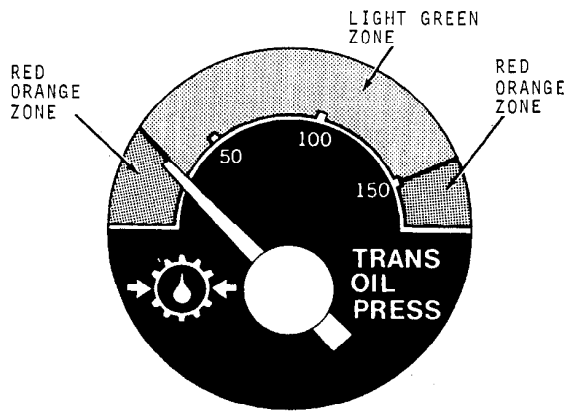

T34531N

Fig. 24-Transmission Oil Pressure Gauge

Normal operating range is indicated by the green zone on the gauge face.

If the transmission oil pressure indicator hand is not in the green zone, stop engine and determine the cause.

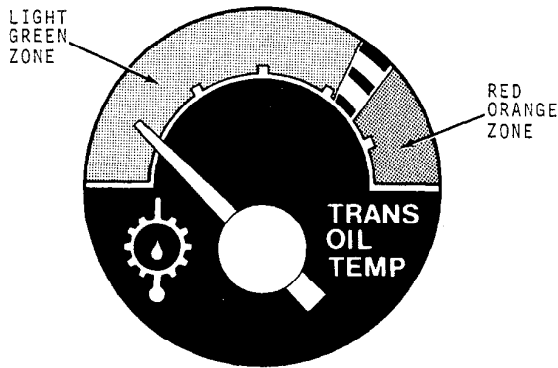

T34530N

Fig. 25-Transmission Oil Temperature Gauge

Normal operating range is indicated by the green zone on the gauge face.

If the transmission oil temperature indicator hand is not in the green zone, stop engine and check oil level.

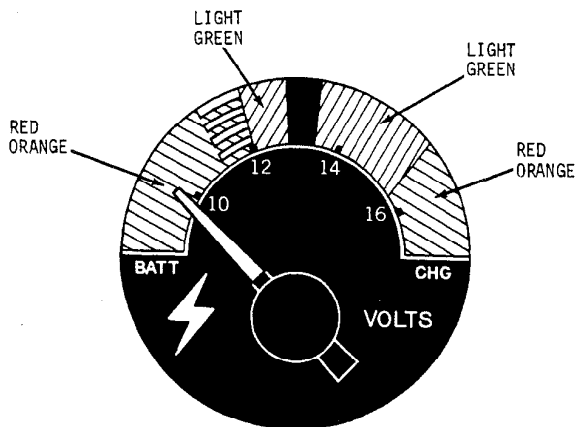

T44558

Fig. 26-Voltmeter

Normal operating range is indicated by the right-hand green zone.

If the voltmeter indicator hand is not in the right-hand green zone, troubleshoot the electrical system.

All gauges operational

Yes No

16. Light Operation

Check light operation.

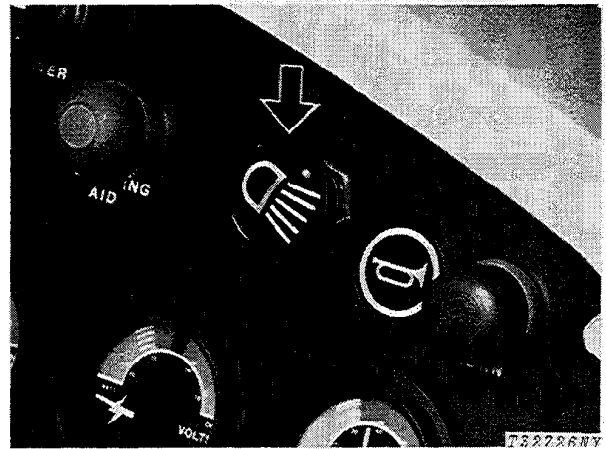

Fig. 27-Light Switch

All lights are controlled by two switches. The headlights, taillights and work lights are controlled by a push-pull light switch located on the right-hand dash panel. The flashing warning lights are controlled by a lever mounted on the steering column.

The light switch mounted on the right-hand dash panel has three positions:

- 1 - Completely In - All lights are off.
- 2 - First Position (Half-way Out) - Headlights and taillights are on.
- 3 - Second Position (Completely Out) - Worklights, headlights and taillights are on.

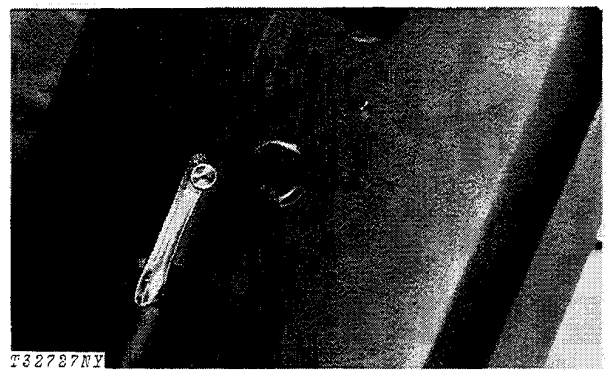

Fig. 28-Turn Signal/Warning Light Switch

The turn signal/warning light switch is used to indicate a right or left turn as well as to operate the flashing lights when in a fully clock-wise position.

All lights operational

Yes No

17. Heater/Air Conditioner Operation

Check the heater operation.

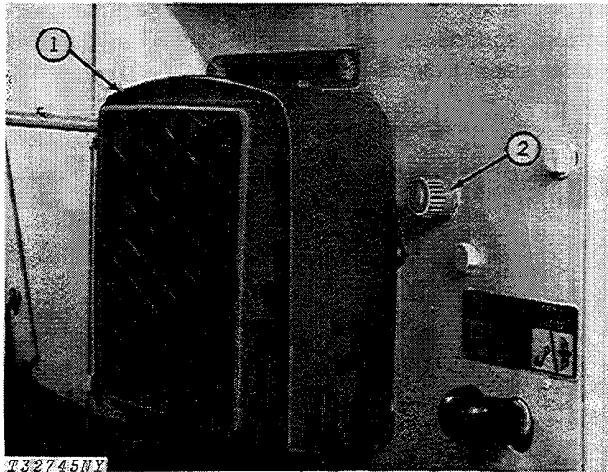

1—Heater

2—Heater Control

Fig. 29-Cab Heater

Turn heater control knob to "ON" position. This position should provide maximum heat.

Turn knob past "ON" position. Heat should gradually decrease as knob is turned to the "stop" position.

If the compactor is equipped with an air conditioner, perform the following check:

NOTE: Ambient air temperature must be at least 60°F (16°C).

1. With the key switch on, operate blower switch in all positions. Observe fan speeds and air volume from air ducts.

2. With key and blower switches on, turn temperature switch toward maximum cooling and listen for audible "click" from compressor clutch.

3. Turn heater valve to closed position.

4. With blower switch at high speed and temperature switch at maximum cooling, operate engine at 2000 rpm.

5. After three minutes, observe sight glass for bubbles. Bubbles may be present immediately after compressor cycles on. If occasional bubbles or a constant stream of bubbles are observed under any other condition, refer to Operational Diagnostic Chart, page 70-16-7.

6. Check temperature of discharge air from air ducts. Hold thermometer in air duct until lowest reading is obtained.

- a. If ambient temperature is above 80°F (27°C), the duct air temperature must be 25 to 30°F (14 to 17°C) below ambient temperature.
- b. If ambient temperature is below 80°F (27°C), the duct air temperature must be less than 50°F (10°C).

7. If unit does not operate as described, refer to Diagnostic Chart, page 70-16-7.

Heater operation checked	Yes	No
Air conditioner operation checked	Yes	No

18. Windshield Wipers

Check the operation of the windshield wipers.

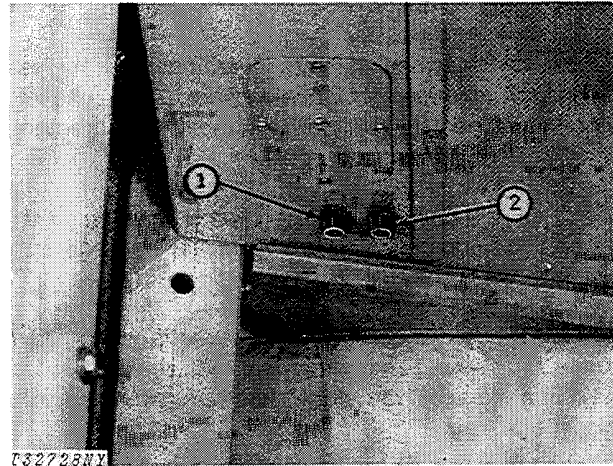

1—Front Wiper Control Knob

2—Rear Wiper Control Knob

Fig. 30-Windshield Wipers

Windshield wipers operational	Yes	No
-------------------------------	-----	----

19. No-Spin Differential Operation

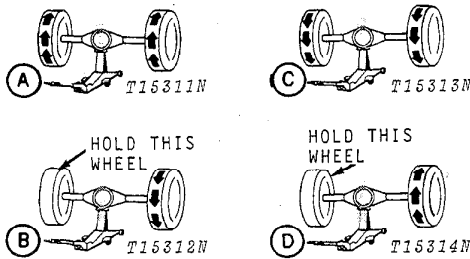

Fig. 31-Test for Proper Operation

Raise front wheels from floor using compactor bucket or floor jack.

(A) With an assistant, rotate both wheels rearward as far as possible. Both wheels will be stopped after rotating only a few inches.

(B) Hold left wheel in the rearward position (against the stop) and rotate right wheel forward. (Again, the left wheel must be held firmly against the stop or the right wheel will not disengage freely.)

(C) Rotate both wheels in a forward direction as far as possible (normally, both wheels will stop after rotating a few inches).

(D) Hold left wheel forward (against the stop), and rotate right wheel rearward. The left wheel must be held firmly against the stop or the right wheel will not disengage freely.

Repeat Steps A, B, C, and D starting with the left wheel. If either wheel does not rotate or "cam" freely in both directions the "No Spin" differential must be removed for inspection.

No-spin differential operation checked Yes No

20. Steering

Start the engine and operate the steering wheel. Steering should be free and easy with engine running. If steering is difficult, see Section 90, Group 25 for testing procedures.

Steering operational Yes No

21. Transmission Operation

The compactor is equipped with a power shift transmission. The power shift transmission has two forward speeds and one reverse speed range. The transmission may be locked in neutral.

Check the transmission operation.

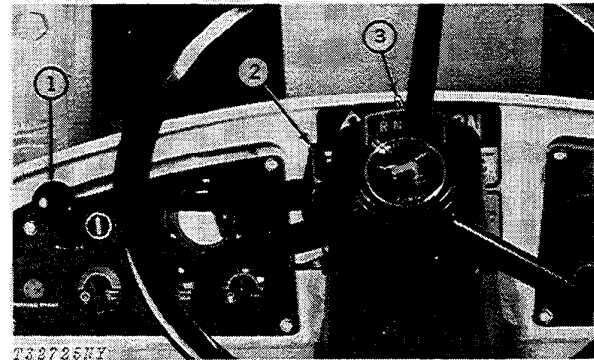

1—Shift Lever 3—Range Indicator
2—Neutral Latch

Fig. 32-Transmission Operation

Shift transmission through all ranges. If transmission does not respond see Section 3 for repair.

Transmission operational Yes No

22. Hydraulic Brakes

Check brake operation.

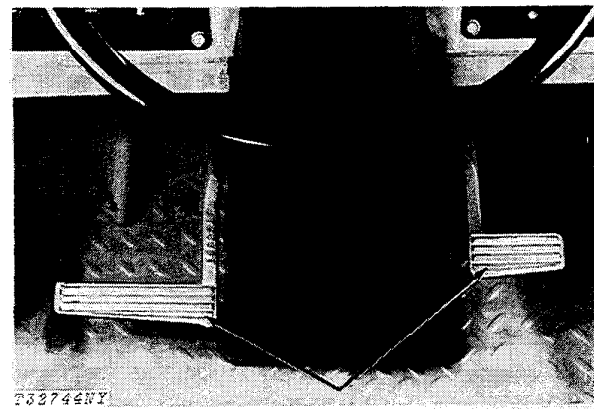

Fig. 33-Brake Pedals

Brakes operational Yes No

23. Clutch Control

Check the clutch control operation.

CAUTION: The clutch control knob should be pushed in (KNOB IN position) when transporting the compactor. The clutch control knob should be pulled out (KNOB OUT position) during loading and dumping operations only. The clutch control knob should be pushed in (KNOB IN position) before stopping on steep inclines. The compactor clutch control knob can be pushed in (KNOB IN position) while the brakes are applied.

The compactor transmission is equipped with a clutch control valve. This valve is operated by a knob located below the seat. With the knob pulled out, the transmission clutches are disengaged when the brake pedal is depressed. When the knob is in this position, the operator, with a full bucket, can approach a refuse pile with the engine at full throttle, depress the brake pedal which disengages the transmission - and obtain maximum hydraulic speed. The unit will not creep forward with the brakes applied.

After the bucket has been emptied into the refuse pile, the operator shifts the compactor into reverse and releases the brakes. When the brake line pressure drops, the transmission clutches re-engage in the normal manner.

The clutch control valve enables the operator to speed up loading and dumping operations.

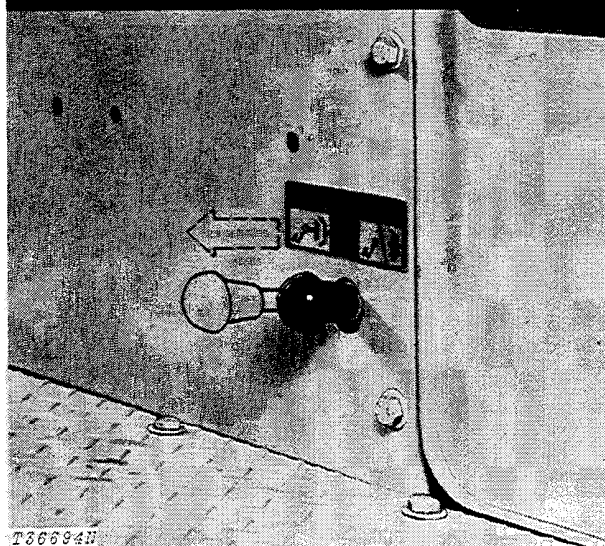
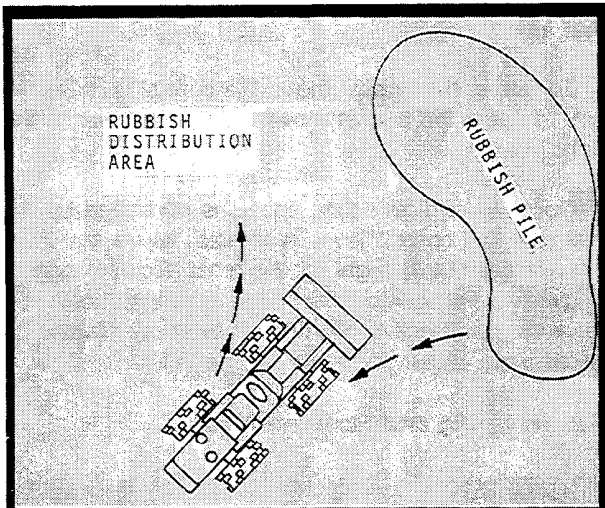

Fig. 34-Transmission Clutches Disengaged By Brake Pedal

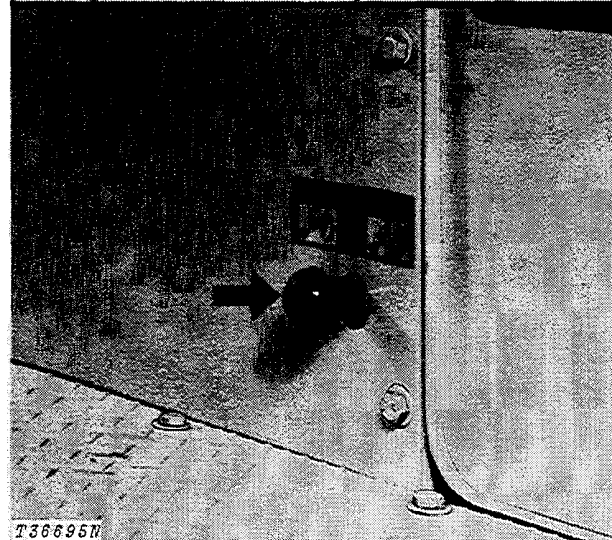
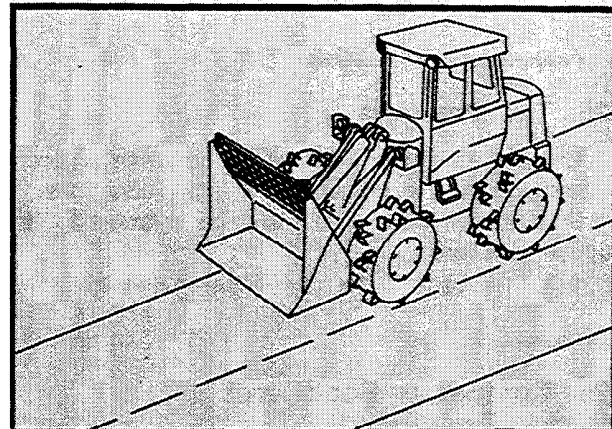

Fig. 35-Transmission Clutches Not Disengaged by Brake Pedal

Clutch control operational

Yes No

24. Fire Extinguisher

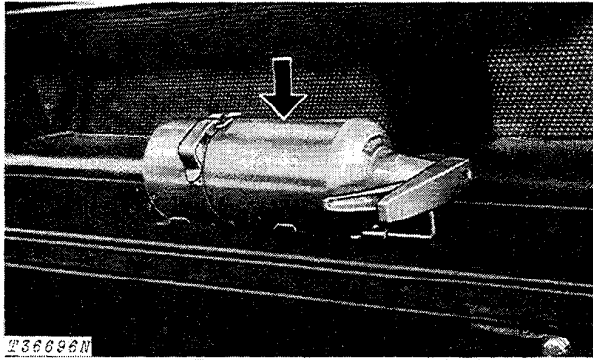

Fig. 36-Fire Extinguisher

Check the charge of the fire extinguisher. If charge is low, replace cartridge.

Fire extinguisher charge adequate * Yes No

25. Tire Pressure

Check the air pressure in all the tires with an accurate gauge having 1-pound (0.45 kg) graduations.

IMPORTANT: All tires must be inflated to the same pressure.

Adjust pressure in tires to 70 psi (4.9 kg/cm²).

Tire pressure checked Yes No

26. Compactor Boom and Bucket Operation

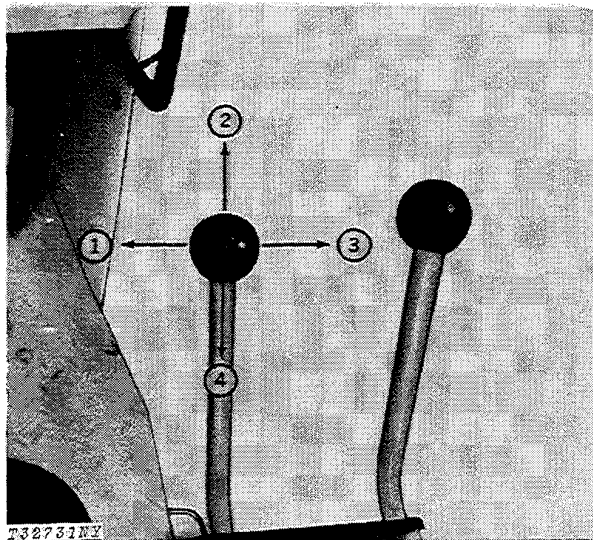

1—Retract Bucket 3—Dump Bucket
 2—Lower Boom 4—Raise Boom

Fig. 37-Boom and Bucket Control Lever

Check the compactor boom and bucket operation.

A single control lever operates the boom and the bucket. When the cylinders have been fully extended or retracted return the valve control lever immediately to the neutral position. This prevents oil from bypassing through the relief valve and becoming overheated.

Move the control lever forward to lower the boom and backward to raise the boom.

Releasing the control lever at any time during normal loader operation will automatically return lever to neutral, holding the boom in the position reached at that time.

To retract the bucket move the control lever to the left; to dump the bucket move the control lever to the right.

Dumping and retracting speed is controlled by the distance the control lever is moved. Move the lever only partially to the right for the most accurate control and maximum power of the bucket cutting edge. When retracting the bucket, maximum power is obtained by moving the lever all the way to the left.

Return to Dig and Float Positions

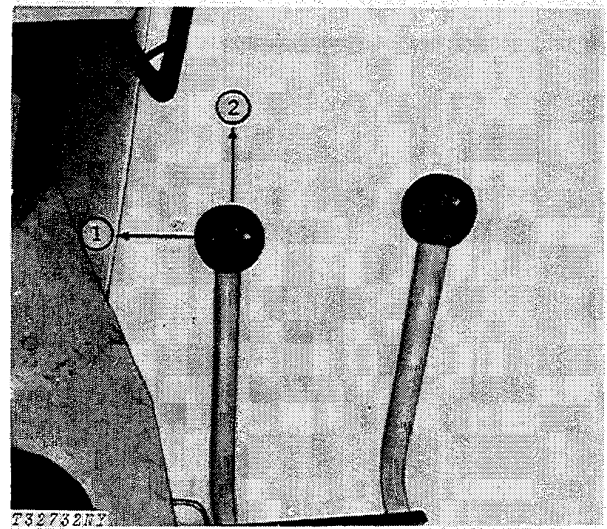

1—Return-to-Dig Detent

2—Float Position Detent

Fig. 38-Return-to-Dig and Float Positions

When the control lever is pulled into the detent at the far left the bucket will return to a predetermined dig position. The lever will return to neutral.

When the lever is pushed all the way forward to the float position, it will stay there until it is manually released. This allows the boom to move up or down as the bucket follows the contour of the ground.

Boom and bucket control lever operational Yes No

27. Seat

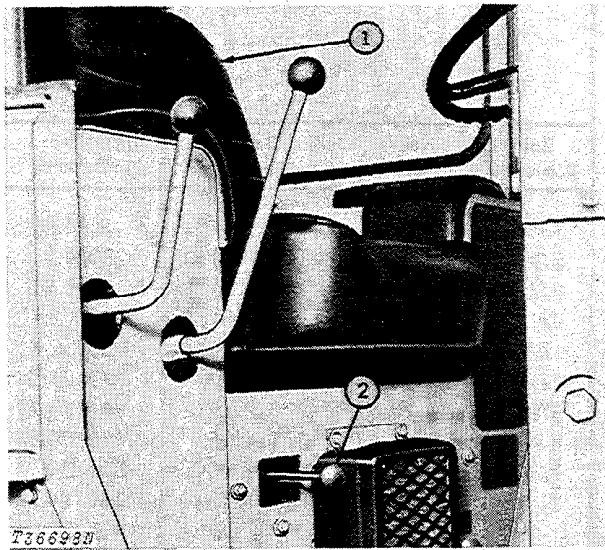

1—Seat

2—Seat Latch

Fig. 39—Seat Operation

Check the seat for proper operation.

To move the seat forward or backward, disengage the seat latch. Slide the seat to the desired position and release the seat latch lever.

Seat operational Yes No

28. Circuit Breakers and Fuses

Check all circuit breakers and fuses. Replace if necessary.

The electrical system and lights are each protected by two 20 amp (20 A) circuit breakers located behind the right-hand instrument panel and fuses located under the left-hand instrument panel (Fig. 40).

The circuit breaker will open when a current of 40 amps (40 A) is applied for one minute. If this happens, turn off the key switch and the circuit breakers will reset themselves in 35 seconds.

The front windshield wiper is protected by a 6 amp circuit breaker.

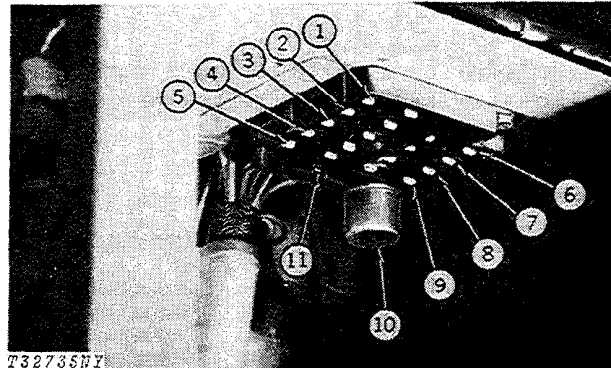

T32735NY

- | | |
|------------------------------------|----------------------------------|
| 1—Injection Pump
(5 amp) (5 A) | 7—Cab Load
(30 amp) (30 A) |
| 2—Starting Aid
(10 amp) (10 A) | 8—Brake Light
(10 amp) (10 A) |
| 3—Horn (30 amp) (30 A) | 9—Turn Signal
(10 amp) (10 A) |
| 4—Taillight (10 amp)
(10 A) | 10—Turn Flasher |
| 5—Back-Up Alarm
(30 amp) (30 A) | 11—Alternator (5 amp)
(5 A) |
| 6—Heater (5 amp) (5 A) | |

Fig. 40—Fuse Identification and Size

Cab Fuses

The rear windshield wiper and defroster fan are protected by a 5 amp (5 A) fuse.

Fuses and circuit breakers checked Yes No
 Fuses replaced, if necessary

29. Bleeding the Fuel System

After removing any components of the fuel system, air should be removed by bleeding. Bleeding is also necessary whenever the fuel tank has been emptied.

Loosen the filter bleed screw on upper left hand side of fuel filter body.

Turn key to start position to start the electric fuel pump. When fuel free of air bubbles comes out of bleed plug, turn key to off position and tighten bleed screw.

Fuel system bled Yes No

30. Parking Brake

Check the parking brake for proper adjustment. Adjust, if necessary.

Forty-five pounds (20 kg) of force is required at top of handle to activate parking brake. See page I-IV-26 to adjust parking brake.

Parking brake adjusted Yes No

31. Wheel Retaining Cap Screws

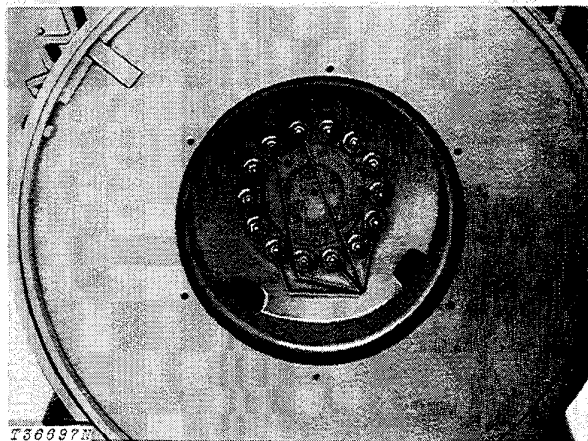

Fig. 41-Wheel Retaining Cap Screws
 (Cepeco Wheel Shown)

Check all wheel retainer cap screw torque. Tighten wheel retaining cap screws on Cepeco and Caron wheels to 450 lb-ft. (62.2 kg/m).

Wheel retaining cap screws tightened Yes No

32. Accessible Hardware Torque Values

Check all accessible bolts and nuts for proper tightness. If hardware seems loose, tighten it to the proper torque. The table below gives correct torque values for various bolts and cap screws. Most hardware used is high-strength (note dashes on hex. heads).

RECOMMENDED TORQUE IN LB-FT [Kg-m] COARSE AND FINE THREADS			
	B	D	F
Bolt Diameter	Plain Head	Three Dashes	Six Dashes
1/4	Not used	10[1.4]	14[1.9]
5/16	Not used	20[2.8]	30[4.1]
3/8	Not used	35[4.8]	50[6.9]
7/16	35[4.8]	55[7.6]	80[11.1]
1/2	55[7.6]	85[11.8]	120[16.6]
9/16	75[10.4]	130[18.0]	175[24.2]
5/8	105[14.5]	170[23.5]	240[33.2]
3/4	185[25.6]	300[41.5]	425[58.8]
7/8	160[22.1]	445[61.5]	685[94.7]
1	250[34.6]	670[92.5]	1030[142.4]
1-1/8	330[45.6]	910[125.8]	1460[201.9]
1-1/4	480[66.4]	1250[172.8]	2060[284.8]

T30882

Fig. 42-Torque Chart

The types of bolts and cap screws are identified by head markings as follows:

Plain Head: regular machine bolts and cap screws.

3-Dash Head: tempered steel high-strength bolts and cap screws.

6-Dash Head: tempered steel extra high-strength bolts and cap screws.

Machine bolts and cap screws 7/8-inch and larger are sometimes formed hot rather than cold, which accounts for the lower torque.

All accessible hardware torqued Yes No

33. Final Check

The final predelivery procedure is overall clean-up of the compactor. Make it LOOK like a new compactor with the proper touch-up of chipped paint and a good wash job. Deliver to the customer a new looking compactor.

DELIVERY SERVICE

A thorough discussion of the operation and service of this new compactor at the time of delivery helps to assure complete customer satisfaction. Proper delivery should be an important phase of a dealer's program. A portion of the John Deere Delivery Receipt emphasizes the importance of proper delivery service.

Many complaints arise because the owner was not shown how to operate and service the new compactor properly. Devote enough time, at the customer's convenience, to introduce the owner to the new compactor. Explain how to operate and service it.

The following procedure is recommended before the service technician and owner complete the delivery acknowledgments portion of the Delivery Receipt.

Using the operator's manual as a guide, be sure that the owner understands these points thoroughly:

1. The importance of safety.
2. The importance of lubrication and periodic services.
3. The importance of the break-in period.
4. Controls and instruments.
5. How to start and stop the engine.
6. All functions of the hydraulic system.

After explaining and demonstrating the above features, have the owner sign the Delivery Receipt and give the owner the operator's manual.

AFTER-SALE INSPECTION

The purchaser of a new John Deere compactor is entitled to a free inspection at some mutually agreeable time within the warranty period after the equipment has been "run in," usually after 50 to 100 hours of operation. The terms of this after-sale inspection are outlined on the customer's John Deere Delivery Receipt.

This inspection is to make sure that the customer is receiving satisfactory performance from the compactor. At the same time, the inspection should reveal whether or not the compactor is being operated, lubricated, and serviced properly.

If the recommended after-sale service inspection is followed, the dealer can eliminate a needless volume of service work by preventing minor irregularities from developing into serious problems later on. This will promote strong dealer-customer relations and present the dealer an opportunity to answer questions that may have arisen during the first few days of operation.

During this inspection service, the dealer has the opportunity to promote the possible sale of other new equipment.

Check operation of all controls and instruments for freedom of movement and correct operation.

1. Engine Crankcase Oil and Filter

NOTE: Check with the customer if oil has been changed and filter replaced before performing this service.

Normal sequence of service is as follows:

Oil Change - after first 100 hours
- every 200 hours thereafter

Filter Change - after first 100 hours
- every 200 hours thereafter

If changed, record information below:

Approximate hours at change _____

If not, change as follows:

Drain crankcase when the oil is hot.

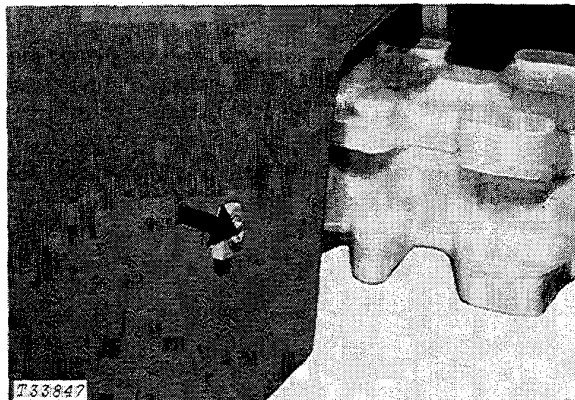

Fig. 43-Crankcase Drain Plug

Remove crankcase drain plug. Plug is located behind right-hand rear wheel. Allow all oil to drain.

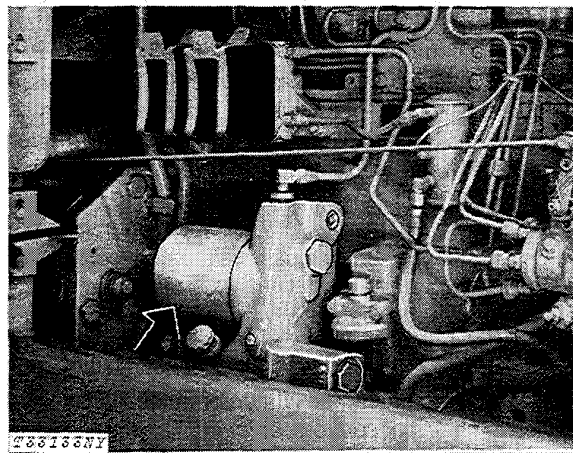
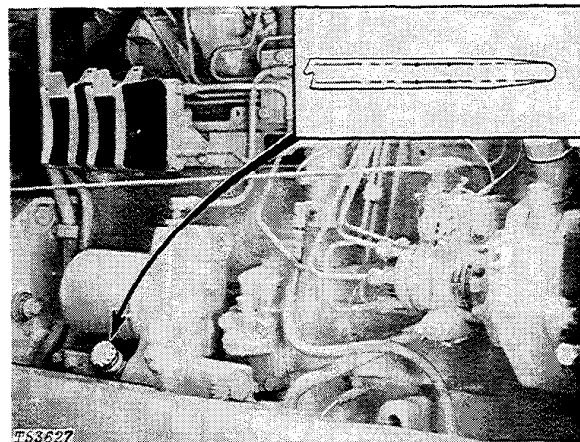

Fig. 44-Engine Crankcase Filter

Leave drain plug out and release crankcase oil filter. Thoroughly clean filter mounting surface and install new elements. Make sure new sealing ring is inserted in end of element. Apply a film of oil to the sealing ring. Turn element until sealing ring touches mounting pad, then turn an additional 1/2 to 3/4 turn. Do not over-tighten.

IMPORTANT: The filter element has a special bypass valve. Use only a John Deere element.

Install drain plug and add 20 qts (19 L) of John Deere TORQ-GARD SUPREME Oil or an equivalent.



A—Crankcase Dipstick

B—Oil Filler Cap

Fig. 45-Checking Crankcase Oil Level

With oil in crankcase, start engine and check for leaks around filter elements. Retighten if necessary, but do not overtighten.

Check crankcase oil level with compactor on level ground and engine off. Allow a minimum of 10 minutes for the oil to drain down before checking. Do not operate the engine with oil level below the bottom mark or above the top mark on the dipstick.

NOTE: There is a two-quart (1.9 L) difference between the bottom mark and the top mark on the dipstick.

Crankcase oil changed	Yes	No
Oil filters changed	Yes	No

2. Hydraulic Reservoir Oil and Filters

NOTE: Before checking oil level find out if customer has changed filter elements (first 50 hours service).

If changed at an earlier date, record information below:

Approximate hours at change _____

If not, change as follows:

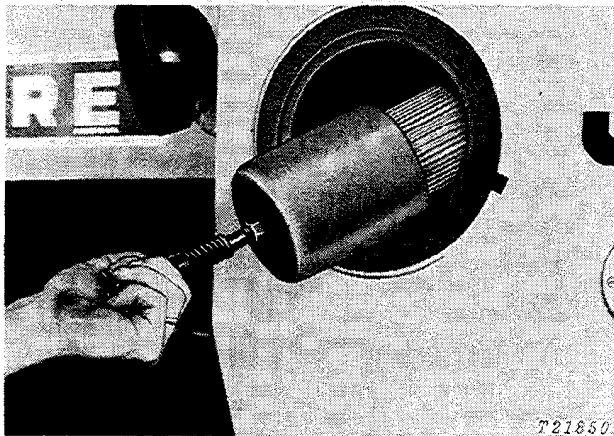
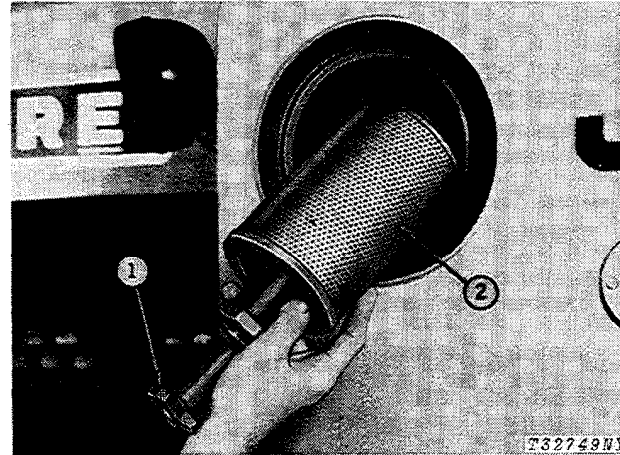

Fig. 46-Suction Filter

Remove reservoir filler cap to relieve pressure. Remove reservoir cover. Remove the wire mesh filter assembly from the reservoir by pulling the spring latch down. Remove the filter from the filter can and wash it in diesel fuel. Blow out the impurities with compressed air. Replace the filter assembly in the reservoir. Make sure the filter assembly is secure.



1—Filter Latch

2—Return Filter

Fig. 47-Return Filters

The return filters are located to the right of the suction filter. Remove by unscrewing the filter latch. After filters are removed from reservoir, remove snap rings to remove filters from filter spacers.

When installing new filters, be sure they are sealed properly and latch is in socket.

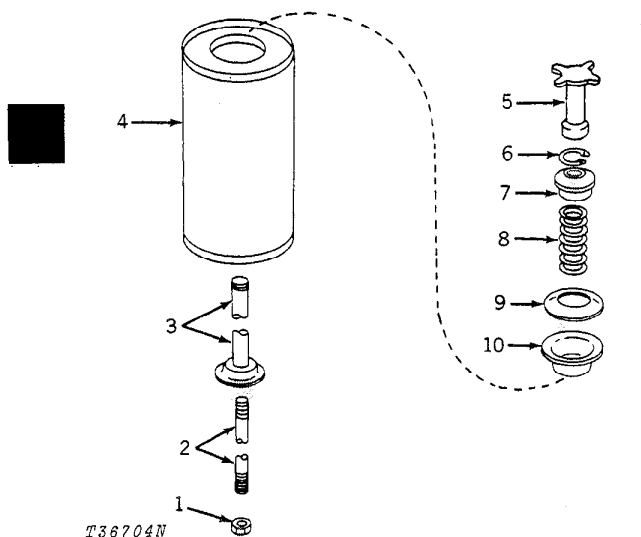

T36704N

- 1—9/16-Inch Nut (2 used)
- 2—Bolt (2 used)
- 3—Filter Spacer (2 used)
- 4—Return Filter (2 used)
- 5—Filter Latch (2 used)
- 6—Snap Ring (2 used)
- 7—Filter Spacer (2 used)
- 8—Spring (2 used)
- 9—Special Spring Washer (2 used)
- 10—Filter Cap (2 used)

Fig. 48-Return Filters Components

Turn latch until tight to insure proper filter engagement. Turn filter latch until a noticeable change in effort is noted, then hand turn the latch a minimum of 1/2 turn. Additional hand tightening of the latch will not damage the filter.

Check compactor hydraulic system oil level.

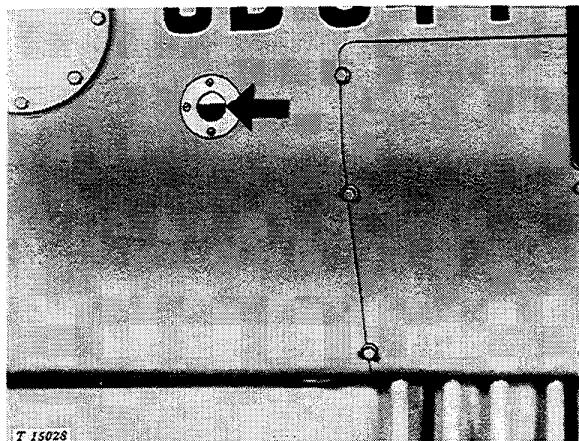

T 15028

Fig. 49-Compactor Hydraulic System Window Indicator

Check compactor hydraulic system oil level with bucket level and resting on the ground. The oil level should be half-way up the window on the reservoir. If oil is low, add enough John Deere HY-GARD Oil to bring level up to this point. The filler opening is located under the lid on top of the reservoir. Prevent dirt from entering system. Do not overfill.

Hydraulic system oil filters changed _____
 Oil added, if any _____ qts. (L)

3. Steering and Transmission Oil Filters

NOTE: Before checking oil level find out if customer has changed filter elements (first 100 hours service).

If changed at an earlier date, record information below:

Approximate hours at change _____

If not, change as follows:

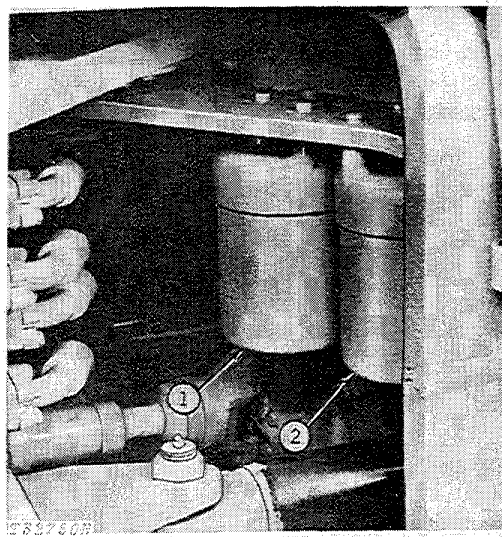

- 1—Transmission Filter
- 2—Steering Oil Filter

Fig. 50-Oil Filters

Remove both the transmission and steering return oil filters. Replace both elements, packings, and O-rings. Tighten filter covers to 55 lb-ft (7.6 kg/m).

Check transmission oil level.

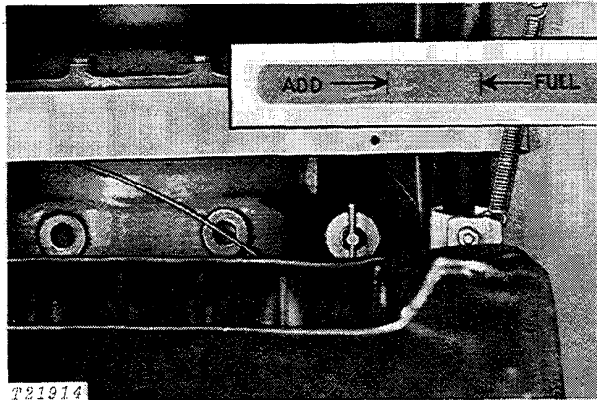

Fig. 51-Transmission Dipstick

A dipstick, located on the left side of the transmission, is accessible by tilting the back of the seat forward. Correct oil level check is made with the dipstick fully inserted in dipstick tube.

Perform both of the following transmission oil level checks: (a) Before starting the engine check the oil level with dipstick. If the oil level is at or near the upper (FULL) mark, there is sufficient oil in the system to permit starting the engine. If oil level is low add John Deere Torque-Converter Fluid (Type C-3) or an equivalent. Replace dipstick and tighten finger tight.

IMPORTANT: Do not use John Deere HY-GARD Oil in the transmission.

Start engine and check for leaks around filter elements. Retighten if necessary, but do not overtighten.

(b) Operate compactor until the transmission reaches normal operating temperature. Idle the engine and shift through all ranges slowly. This will fill all parts in the system with oil. Shift to neutral, apply the brakes and allow engine to idle. Check oil level again. It should now be at or above the lower (ADD) mark and not above the upper (FULL) mark on the dipstick. If below the add mark, add oil. Do not overfill.

Transmission and steering
 filters changed
 Oil added, if any

Yes No
 _____ qts. (L)

4. Front and Rear Differential Oil Level

Check front and rear differential oil level.

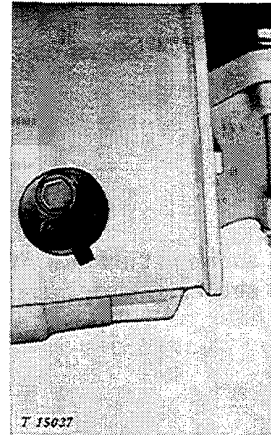

Fig. 52-Front Differential Check Plug

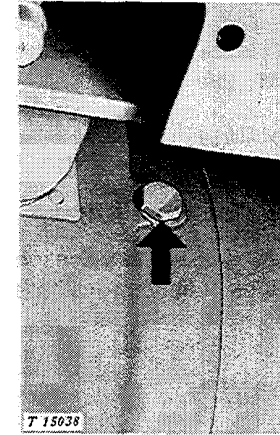

Fig. 53-Rear Differential Check Plug

Check oil level at oil level - filler plug on the side of the differential housings. Oil must be cold and compactor must be on level ground. The oil level should be up to the plug. Add John Deere HY-GARD Oil or an equivalent, if necessary.

Differential oil levels
 checked
 Oil added, if any

Yes No
 _____ qts. (L)

5. Radiator

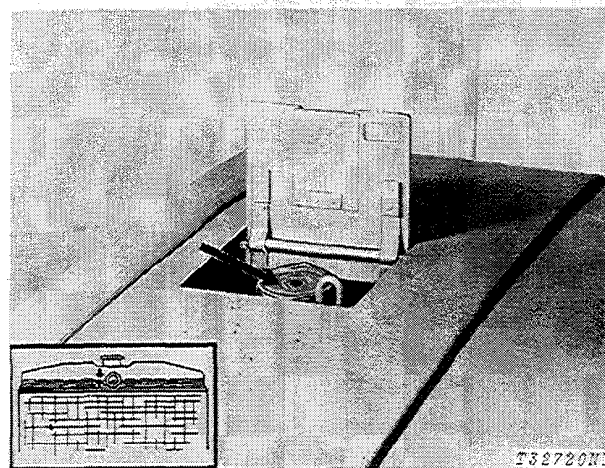

Fig. 54-Radiator Filler Cap

CAUTION: Do not remove radiator filler cap until the coolant temperature is below its boiling point. Then loosen cap to the stop to relieve pressure before removing cap completely.

Check the level of the coolant in the radiator. Coolant level should be midway between the radiator core and filler neck.

Radiator coolant level checked Yes No
 Coolant or antifreeze added, if any _____ qts. (L)

6. Grease Fittings

Check each lubrication point shown in the following pages. Lubricate with several strokes, if necessary.

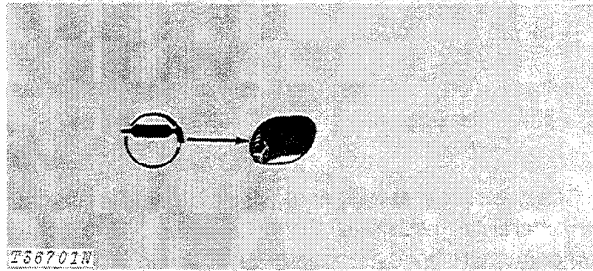

Fig. 55-Steering Cylinder Rear Pivot Pins (2 Points)

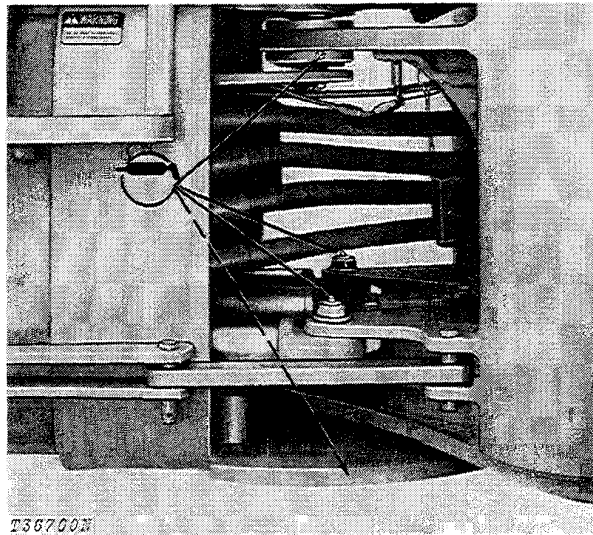

Fig. 56-Steering Cylinder Front Pivot Pins (2 Points) and Frame Hinge Pivots (2 Points)

Lubricant required Yes No

Lubricate all pivot pins in the loader linkage from the control lever to the control valves with engine oil.

Lubricant required Yes No

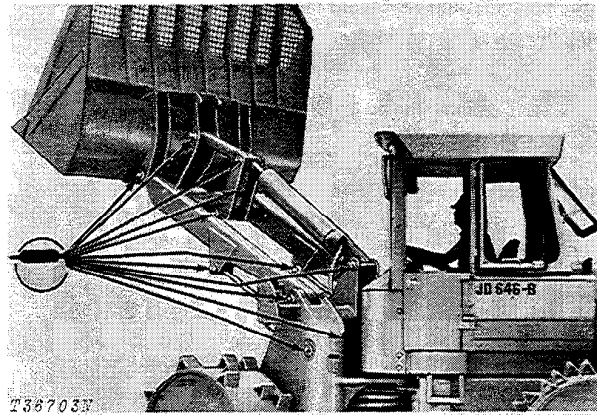

Fig. 57-Compactor Boom and Bucket Cylinders and Pivots (14 Points)

Lubricant required Yes No

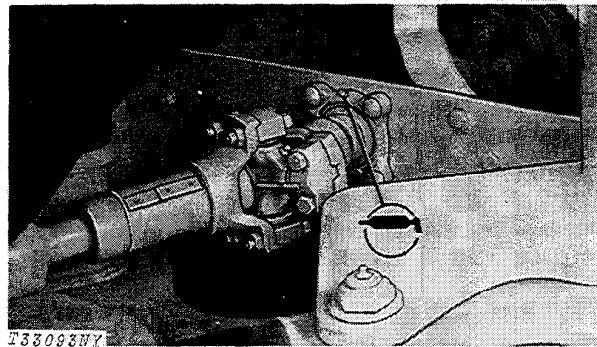

Fig. 58-Front Drive Shaft Support Bearing (1 Point)

Lubricant required Yes No

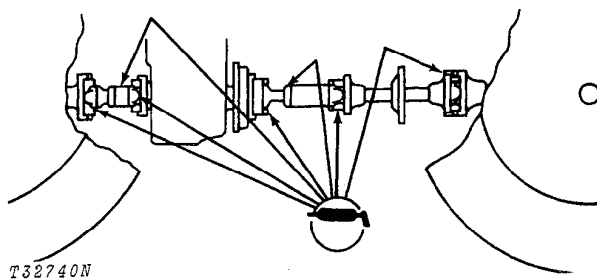

Fig. 59-Transmission-to-Differential Drive Lines (7 Points)

Lubricant required Yes No

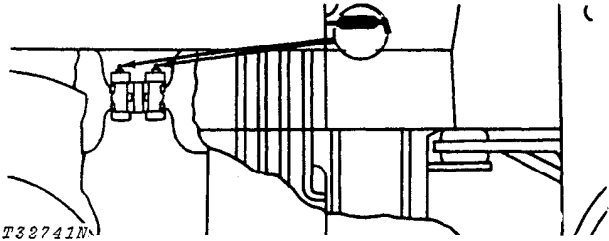

Fig. 60-Engine-to-Transmission
 Universal Joint (2 Points)

Lubricant required Yes No

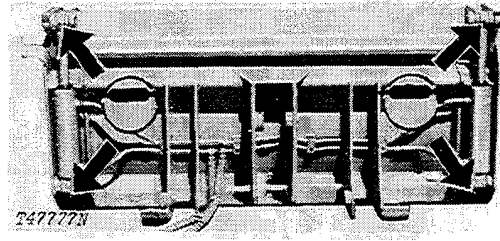

Fig. 63-Multi-Purpose Bucket Pivots (4 Points)

Lubricant required Yes No

7. Pre-cleaner

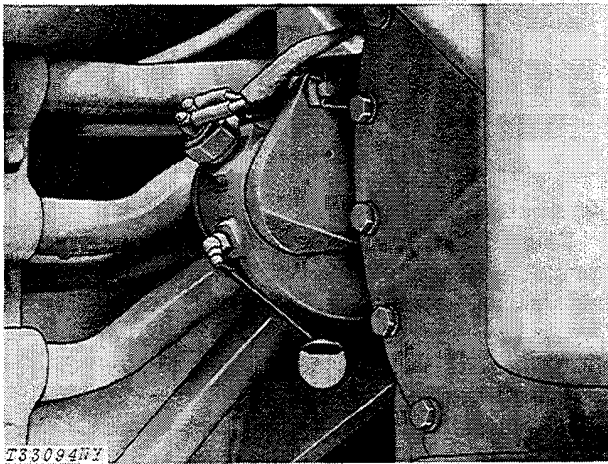

Fig. 61-Shift Control Bell Crank Fitting (1 Point)

Lubricant required Yes No

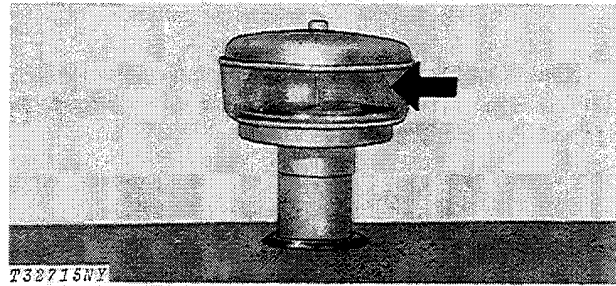

Fig. 64-Pre-cleaner

Check and clean pre-cleaner bowl.

Pre-cleaner checked and cleaned Yes No

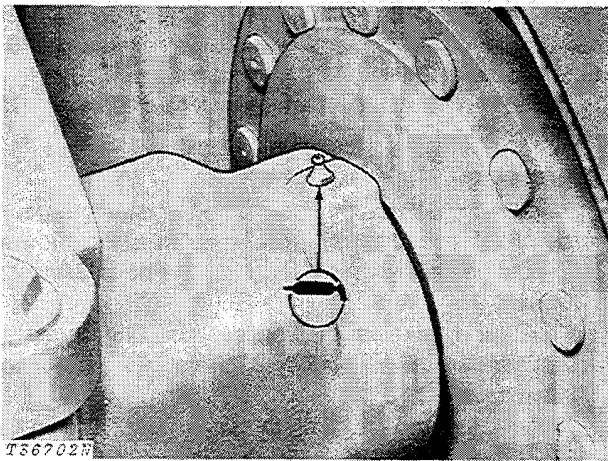

Fig. 62-Axle Bearing Grease Fitting
 (Front Shown) (4 Points)

Lubricant required Yes No

8. Air Cleaner



Fig. 65-Air Cleaner Restriction Indicator

Check air filter restriction indicator. If red signal locks in full view, remove and clean primary element. Replace element if necessary.

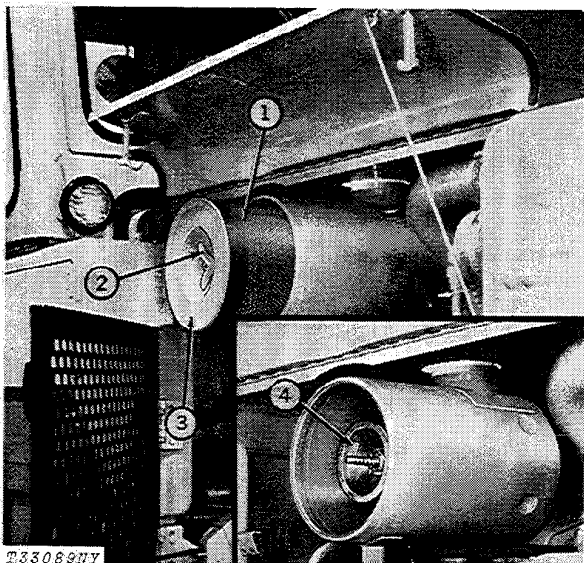

- 1—Primary Filter Element
- 2—Wing Nut
- 3—Air Cleaner Cover Element
- 4—Secondary Filter Element

Fig. 66-Air Cleaner

Air cleaner checked	Yes	No
Filters replaced or cleaned	Yes	No

9. Alternator-Fan Belt Tension

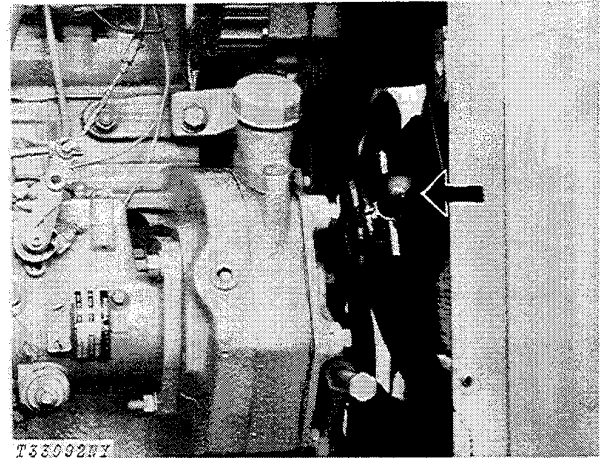

Fig. 67-Alternator Belt Tension

Alternator Belt Tension

Check alternator belt tension using a belt tension gauge. A force of 17 pounds (76 N) on the alternator belt midway between the pulleys should deflect the belt 1/4 inch (6.4 mm).

IMPORTANT: Apply outward force to FRONT of alternator housing only.

To adjust, loosen alternator bracket and adjusting cap screws. Apply outward pressure to the front alternator frame. Adjust to desired tension. Tighten adjusting cap screws on alternator bracket.

When a strand tension gauge is used, the initial reading should be 130 to 140 pounds (579 to 693 N) strand tension. After 3 minutes of operation recheck belt tension. The gauge should read a minimum of 85 to 95 pounds (378 to 423 N) strand tension.

NOTE: Recheck belt tension after adjustment. DO NOT OVERTIGHTEN.

Fan Belt Tension

Check fan belt tension using a belt tension gauge. A force of 20 pounds (89 N) on the fan belts midway between the pulleys should deflect the belts 3/4 inch (19 mm).

To adjust, turn the idler pulley adjusting screw to adjust tension on idler pulley. Tighten idler pulley adjusting screw.

When a strand tension gauge is used, the initial reading should be 95 to 105 pounds (423 to 467 N) strand tension. After 3 minutes of operation recheck belt tension. The gauge should read a minimum of 85 to 95 pounds (378 to 422 N) strand tension.

NOTE: Recheck belt tension after adjustment. DO NOT OVERTIGHTEN.

Alternator belt checked	_____ lb. (kg) tension
	_____ in. (mm) flex
Fan belt checked	_____ lb. (kg) tension
	_____ in. (mm) flex

10. Tire Pressure

Check the air pressure in all the tires with an accurate gauge having 1 psi (0.07 kg/cm²) graduations.

IMPORTANT: All tires must be inflated to the same pressure.

Adjust pressure in tires to 70 psi (4.9 kg/cm²).

Tire pressure checked Yes No

11. Fuel Filters

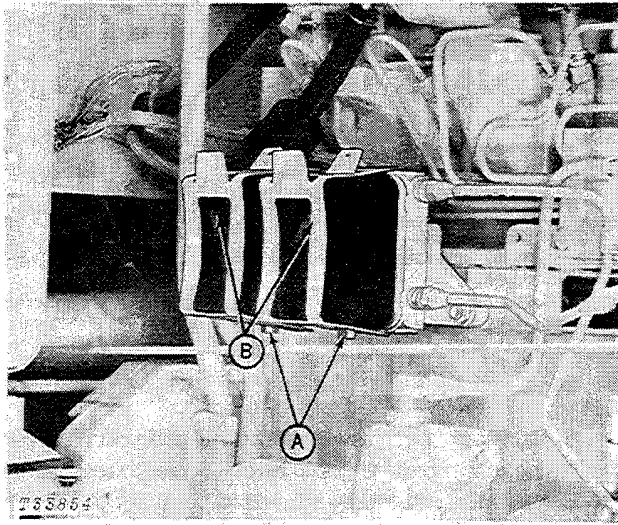

A—Fuel Filter Drain Plugs

B—Fuel Filters

Fig. 68-Fuel Filters

Check fuel filters and drain any sediment that is present.

Sediment present in filters Yes No

12. Batteries

Check battery electrolyte level. Batteries are located to the left of the operator and are accessible through the top door in the battery compartment. If distilled water is not available, use clean soft water. Avoid use of hard water. Remove foreign material from top of battery and coat terminals with petroleum jelly. Check vent holes in battery caps.

IMPORTANT: Never add water to battery in freezing weather unless engine is to be run two or three hours to assure mixing of water and electrolyte.

Check battery connections.

Water added Yes No

13. Charging System

Check charging system as follows:

a. With the engine off the voltmeter should be in the lower left green zone (12-13 volts).

b. With the engine running the voltmeter should be in the upper green zone (14-15 volts).

Charging system operational Yes No

14. Light Operation

Check light operation.



Fig. 69-Light Switch

The headlights, combination stop lights and taillights and the work lights are controlled by a push-pull light switch located on the right hand dash panel.

The light switch has three positions:

Completely In. - All lights are off.

First Position (Halfway Out)

- Headlights and combination stop lights and taillights are on.

Second Position (Completely Out) -

Work lights, headlights and combination stop lights and taillights are on.

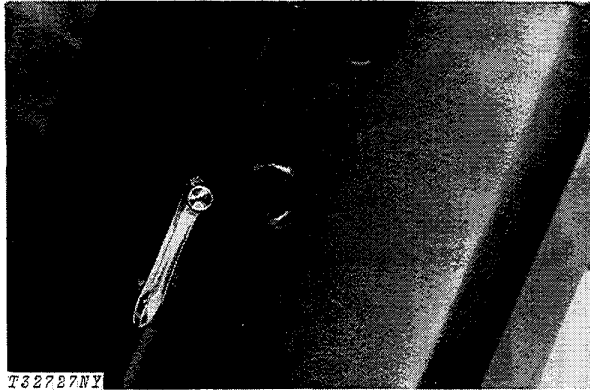

T32727NY

Fig. 70-Turn Signal and Warning Light Switch

The turn signal and warning light control switch is used to indicate a right or left turn. To indicate a left turn, pull switch lever counterclockwise. To indicate a right turn push switch lever to first clockwise position.

The flashing warning lights may be turned on by turning the switch fully clockwise (second position).

Lights operational Yes No

15. Gauge Operation

When operating the compactor, check all gauges to see if they are operational and indicator hands are responsive.

Gauges operational Yes No

If no, explain malfunction _____

16. Engine Speeds

Warm up engine and attach a tachometer to the engine tachometer drive to check engine speeds.

No load, fast idle speed should be 2400 rpm. Slow idle should be 700 rpm.

If engine speeds need adjustment, adjust as follows:

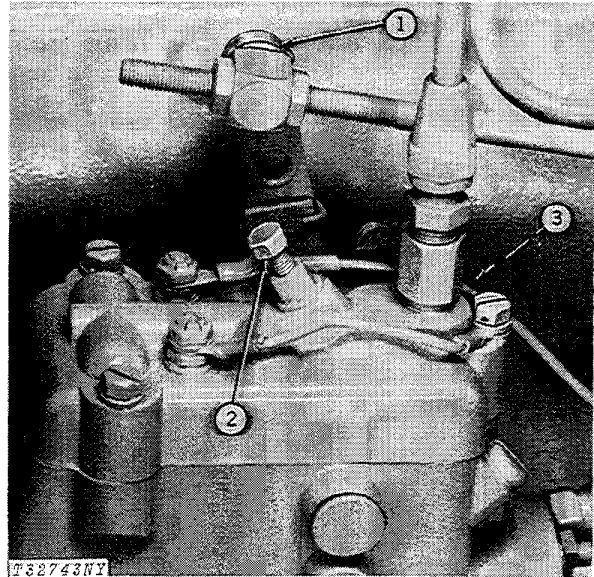

T32743NY

1—Throttle Lever
2—Slow Idle Stop Screw

3—Fast Idle Stop Screw

Fig. 71-Pump Idle Adjustments

Disconnect throttle swivel from injection pump lever. Run engine and rotate pump throttle lever to rear until it touches stop. Engine speed should be at 2400 rpm fast idle. If not, adjust pump fast-idle stop screw to correct.

Lightly rotate pump throttle lever forward to slow idle position. Engine speed should be at 700 rpm slow idle. If not, adjust at pump slow idle stop screw.

Linkage Adjustments

Override on pump throttle lever should be 1/4-inch (6 mm) preloaded at both fast and slow idle positions. Proceed with speed adjustments as follows:

With engine off, position fast idle adjustment screw located under accelerator pedal 2.00 in. (51 mm) above platform lugs. Lock screw in place.

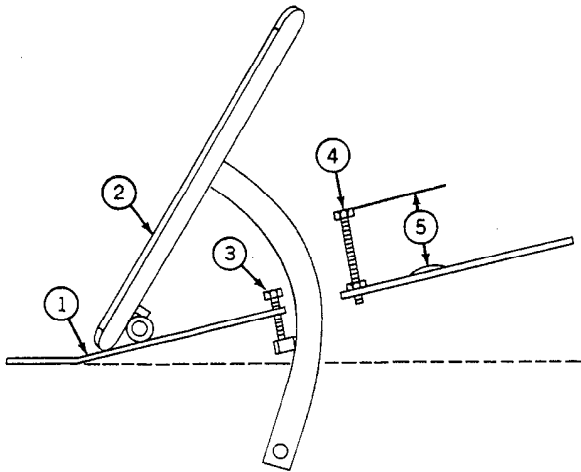

T35891N

- 1—Platform
- 2—Accelerator Pedal
- 3—Slow Idle Screw
- 4—Fast Idle Adjustment Screw
- 5—2.00 inches (51 mm)

Fig. 72—Accelerator Pedal Adjustments

Disconnect throttle swivel from injection pump lever. Hold the accelerator pedal down against fast idle screw. At the injection pump, pull the lever against fast idle position and hold. Adjust swivel on the injection pump control rod so the pin will just go into position. Remove the swivel from the lever. Shorten the injection pump control rod 3-1/2 turns. Tighten locking nut.

Allow accelerator pedal to return to slow idle position. With engine running adjust length of slow idle stop screw under accelerator pedal until engine rpm just increases from slow idle setting. Back out slow idle adjusting screw 2 turns (1/8 in. [3 mm]). Tighten locking nut.

Engine speeds checked	Yes	No
Adjustments required	Yes	No

17. Upper Pivot Pin Stop Nut

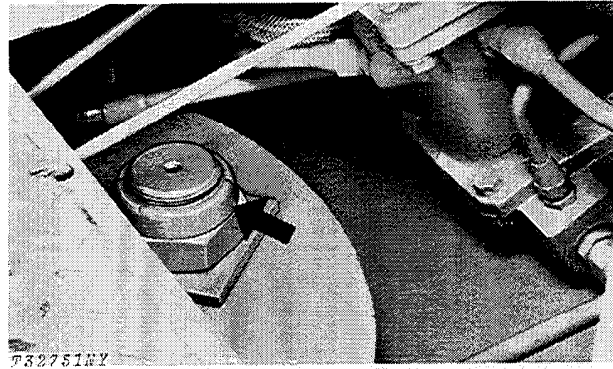

Fig. 73—Upper Pivot Pin Stop Nut

Remove right-hand floor panel. Tighten upper pivot pin stop nut to 1000 lb-ft (138 kg-m).

Pivot pin stop nut tightened	Yes	No
------------------------------	-----	----

18. Wheel Retaining Cap Screws

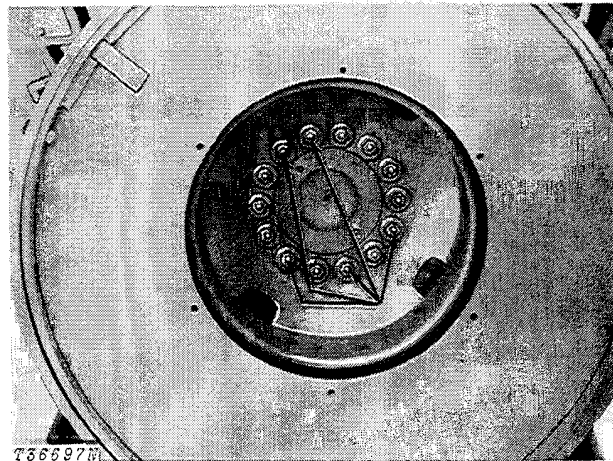

Fig. 74—Wheel Retaining Cap Screws

Check all wheel retaining cap screw torque. Tighten wheel retaining cap screws to 450 lb-ft (62.2 kg-m).

Wheel retaining cap screws tightened	Yes	No
--------------------------------------	-----	----

19. Fire Extinguisher

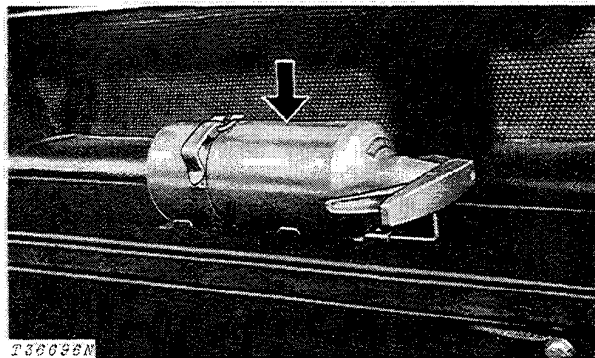

Fig. 75-Fire Extinguisher

Check the charge of the fire extinguisher. If charge is low, replace cartridge.

Fire extinguisher charge adequate Yes No

20. Hydraulic Brakes

Check brake operation.

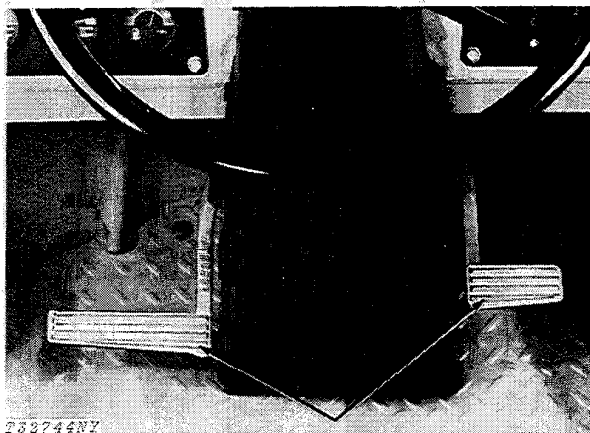

Fig. 76-Brake Pedals

Brakes operational Yes No

21. Parking Brake

Check parking brake for proper adjustment. Adjust, if necessary.

NOTE: It requires 45 pounds (20 kg) of force at the handle to activate the parking brake. If the force is more or less than 45 pounds (20 kg), adjust parking brake.

Adjust parking brake by turning parking brake lever knob until the lever locks tightly over center. When no longer possible to turn the knob, unscrew it completely and make the adjustment in the rod and yoke assembly where it attaches to the transmission brake lever. Adjust length so that the parking brake lever locks tightly over center with the knob on the parking brake lever completely unscrewed.

Check to make sure transmission output shaft is not leaking oil on the brake drum.

Also check for scorched paint on brake drum. This would indicate compactor is being driven with parking brake on.

Parking brake operational Yes No

22. No-Spin Differential Operation

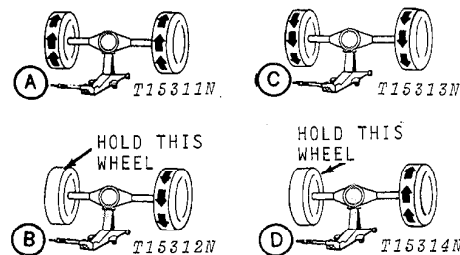

Fig. 77-Test for Proper Operation

Raise front wheels from floor using loader bucket or floor jack.

(A) With an assistant, rotate both wheels rearward as far as possible. Both wheels will be stopped after rotating only a few inches.

(B) Hold left wheel in the rearward position (against the stop) and rotate right wheel forward. (Again, the left wheel must be held firmly against the stop or the right wheel will not disengage freely.)

(C) Rotate both wheels in a forward direction as far as possible (normally, both wheels will stop after rotating a few inches).

(D) Hold left wheel forward (against the stop), and rotate right wheel rearward. The left wheel must be held firmly against the stop or the right wheel will not disengage freely.

Repeat Steps A, B, C, and D starting with the left wheel. If either wheel does not rotate or "cam" freely in both directions the "No Spin" differential must be removed for inspection.

No-spin differential operation checked Yes No

23. Clutch Control

Check the clutch control operation.

CAUTION: The clutch control knob should be pushed in (KNOB IN position) when transporting the compactor. The clutch control knob should be pulled out (KNOB OUT position) during loading and dumping operations only. The clutch control knob should be pushed in (KNOB IN position) before stopping on steep inclines. The compactor clutch control knob can be pushed in (KNOB IN position) while the brakes are applied.

The compactor transmission is equipped with a clutch control valve. This valve is operated by a knob located below the seat. With the knob pulled out, the transmission clutches are disengaged when the brake pedal is depressed. When the knob is in this position, the operator, with a full bucket, can approach a refuse pile with the engine at full throttle, depress the brake pedal which disengages the transmission - and obtain maximum hydraulic speed. The unit will not creep forward with the brakes applied.

After the bucket has been emptied into the refuse pile, the operator shifts the compactor into reverse and releases the brakes. When the brake line pressure drops, the transmission clutches re-engage in the normal manner.

The clutch control valve enables the operator to speed up loading and dumping operations.

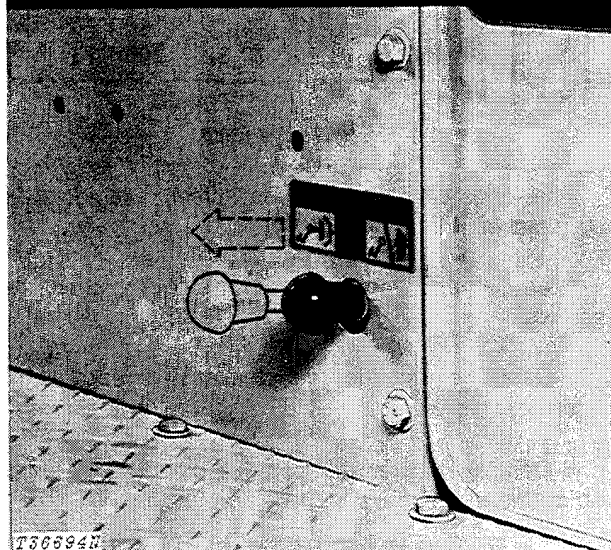
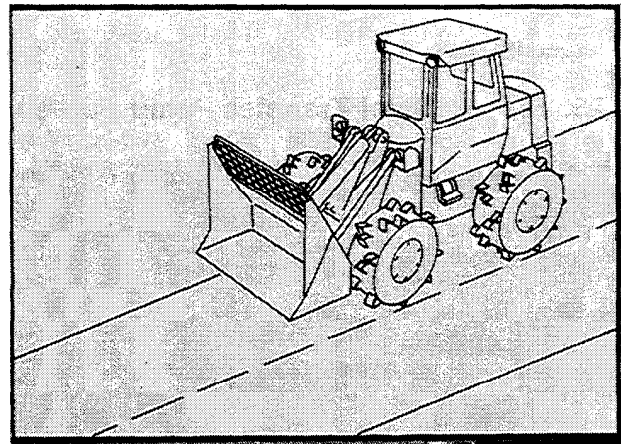
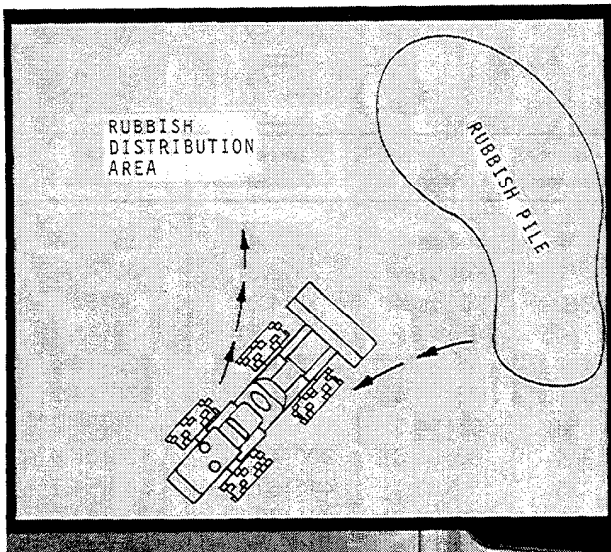

Fig. 78-Transmission Clutches Disengaged By Brake Pedal

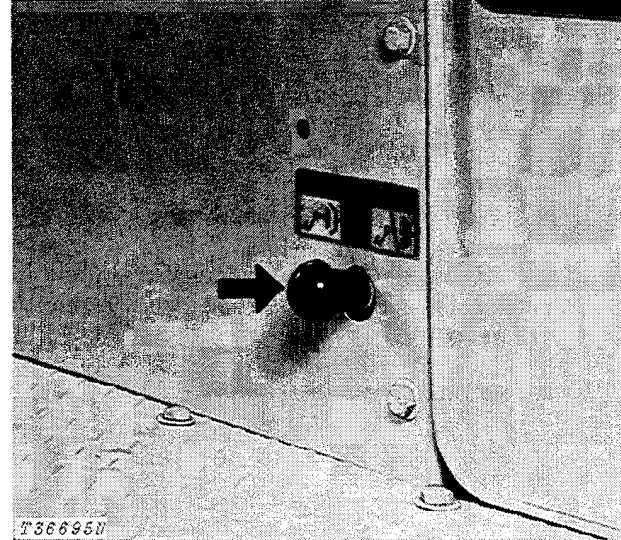

Fig. 79-Transmission Clutches Not Disengaged by Brake Pedal

Clutch control operational

Yes No

24. Accumulator Action

If braking action is poor or erratic after bleeding the brakes, check brake accumulator reserve capacity as follows:

Before starting engine, operate brake pedal several times. Pedal travel should not exceed 2 inches (50.8 mm) with firm but moderate pedal effort. Excessive pedal travel means the accumulator has no reserve capacity.

Start engine and run approximately one minute. Stop engine and discharge steering accumulator by cycling steering wheel. Operate brake pedal twenty applications. After twenty applications, pedal travel should not exceed 2 inches (50.8 mm) with firm but moderate pedal effort. If accumulator does not have sufficient reserve capacity, have your John Deere dealer check the accumulator.

Accumulator checked

Yes No

25. Electric Fuel Transfer Pump Screen

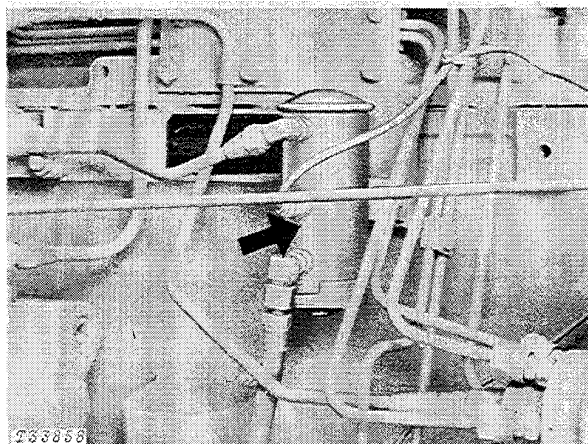

Fig. 80-Fuel Transfer Pump

The fuel transfer pump is equipped with a replaceable screen. Remove screen and replace with a new screen.

Electric fuel transfer pump screen changed

Yes No

26. Accessible Hardware Torque Values

Check all accessible bolts and nuts for proper tightness. Discuss with the customer the importance of maintaining the proper tightness of all compactor hardware. If hardware is loose, tighten it to the proper torque. The chart below gives correct torque values for various bolts and cap screws. Most hardware used is high-strength (note dashes on hex. heads).

RECOMMENDED TORQUE IN LB-FT [Kg-m] COARSE AND FINE THREADS			
B D F			
Bolt Diameter	Plain Head	Three Dashes	Six Dashes
1/4	Not used	10 [1.4]	14 [1.9]
5/16	Not used	20 [2.8]	30 [4.1]
3/8	Not used	35 [4.8]	50 [6.9]
7/16	35 [4.8]	55 [7.6]	80 [11.1]
1/2	55 [7.6]	85 [11.8]	120 [16.6]
9/16	75 [10.4]	130 [18.0]	175 [24.2]
5/8	105 [14.5]	170 [23.5]	240 [33.2]
3/4	185 [25.6]	300 [41.5]	425 [58.8]
7/8	160 [22.1]	445 [61.5]	685 [94.7]
1	250 [34.6]	670 [92.5]	1030 [142.4]
1-1/8	330 [45.6]	910 [125.8]	1460 [201.9]
1-1/4	480 [66.4]	1250 [172.8]	2060 [284.8]

T30882

Fig. 81-Torque Chart

The types of bolts and cap screws are identified by head markings as follows:

Plain Head: regular machine bolts and cap screws.

3-Dash Head: tempered steel high-strength bolts and cap screws.

6-Dash Head: tempered steel extra high-strength bolts and cap screws.

Machine bolts and cap screws 7/8-inch (22 mm) and larger are sometimes formed hot rather than cold, which accounts for lower torque.

All accessible hardware torqued

Yes No

27. Fluid Leakage

Check the following systems for leakage due to poor or faulty connections and broken hoses or lines.

- | | | |
|-----------------------------------|-----|----|
| A. Cooling system checked OK | Yes | No |
| B. Hydraulic system checked OK | Yes | No |
| C. Transmission system checked OK | Yes | No |
| D. Fuel system checked OK | Yes | No |

If answer to any of the above is no, please explain.





3. Axle Bearings

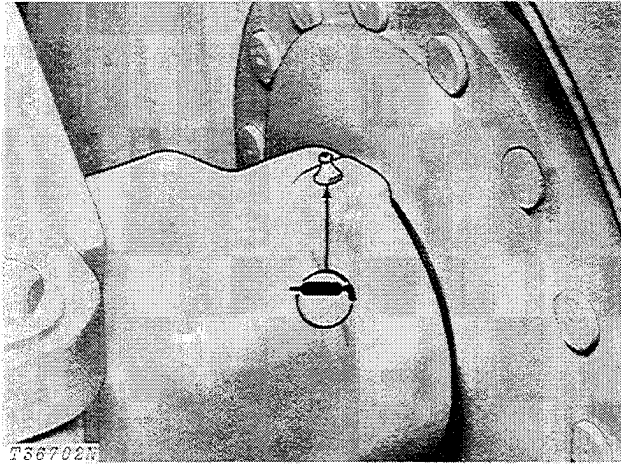

Fig. 78-Axle Bearing Grease Fitting (Front Shown)

Lubricate the bearings with 10 to 12 shots from a low pressure grease gun using John Deere Multi-Purpose Lubricant or an equivalent.

Grease fittings lubricated Yes No

4. Compactor Boom and Bucket Cylinders and Pivots

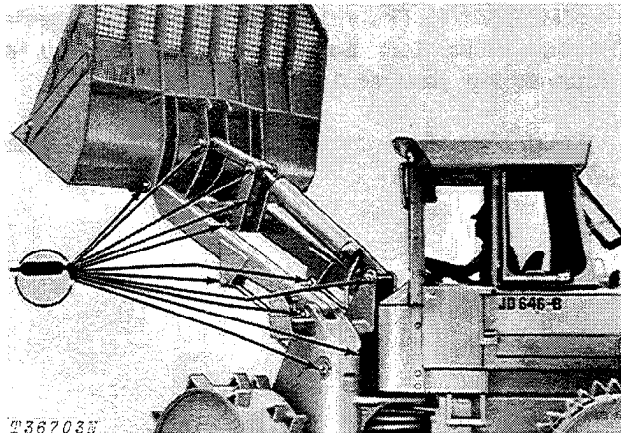

Fig. 79-Compactor Boom and Bucket Cylinders and Pivots

Lower boom to ground and lubricate the boom and bucket cylinders and pivots with John Deere Multi-Purpose Lubricant or an equivalent. There are 14 grease fittings. Also lubricate clam pivot fittings on multi purpose bucket. Scrape off any dirt packed between lower clam cylinder pivots and side of bucket.

Grease fittings lubricated Yes No

5. Front Drive Shaft Support Bearing

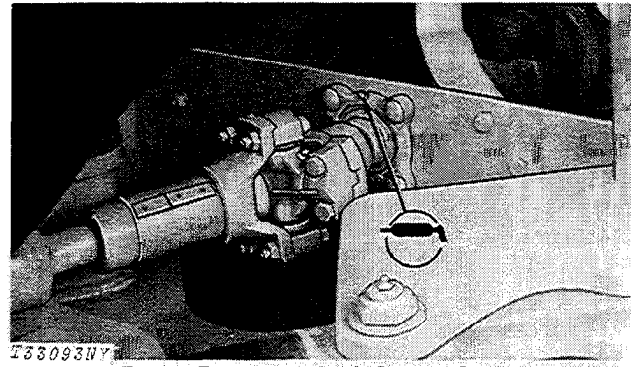

Fig. 80-Front Drive Shaft Support Bearing

Lubricate front drive shaft support bearing with John Deere Multi-Purpose Lubricant or an equivalent.

Lubricate until fresh grease escapes around seal.

Grease fittings lubricated Yes No

6. Transmission to Differential Drive Lines

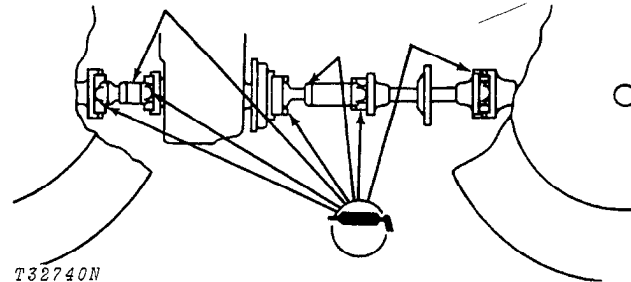

Fig. 81-Lubricating Points

Lubricate the transmission to differential drive line grease fittings with a low pressure grease gun containing John Deere Multi-Purpose Lubricant or an equivalent. Lubricate until grease appears at all four bearing cups.

IMPORTANT: Lubricate daily or every 10 hours when operating in deep mud or water.

Grease fittings lubricated Yes No

7. Engine to Transmission Universal Joint

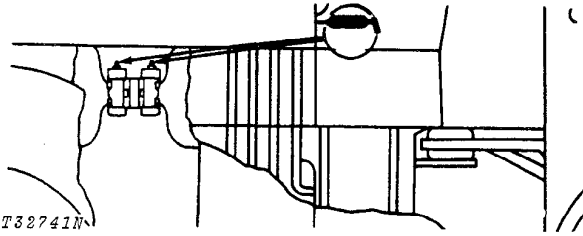

Fig. 82-Lubricating Points

Lubricate the two grease fittings on engine-to-transmission universal joint with John Deere Multi-Purpose Lubricant or an equivalent. Grease slowly until grease appears at each bearing cup. Avoid using high-pressure grease gun.

Grease fittings lubricated Yes No

8. Compactor Control Lever

Lubricate all pivot points in the linkage from the control lever to the control valves with engine oil.

Pivot points lubricated Yes No

TIRE PRESSURE

9. Tire Pressure

Check the air pressure on all the tires with an accurate gauge having 1-pound (0.45 kg) graduations.

IMPORTANT: All tires must be inflated to the same pressure.

Adjust pressure in all tires to 70 psi (4.9 kg/cm²).

CHANGE FILTERS

1. Engine Crankcase Filters

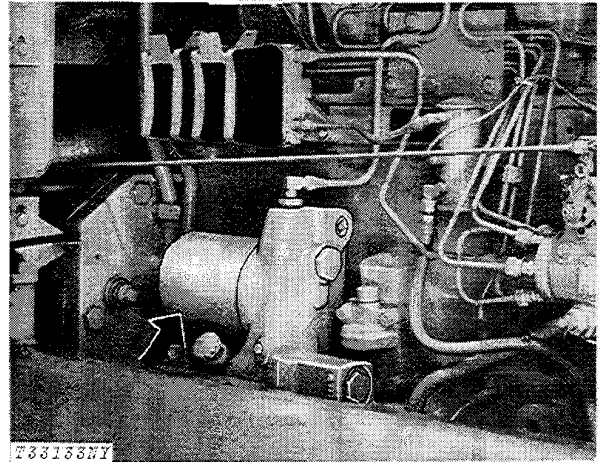

Fig. 83-Engine Crankcase Filter

Remove filter element. Thoroughly clean filter mounting surface and install new element. Make sure new sealing ring is inserted in end of element. Apply a film of oil to the sealing ring. Turn element until sealing ring touches mounting pad, then turn an additional 1-1/2 turns. Do not overtighten.

IMPORTANT: The filter element has a special bypass valve. Use only a John Deere element supplied by your dealer.

NOTE: The filter contains approximately 1 quart (0.95 l) of oil.

2. Compactor Reservoir Return Filters

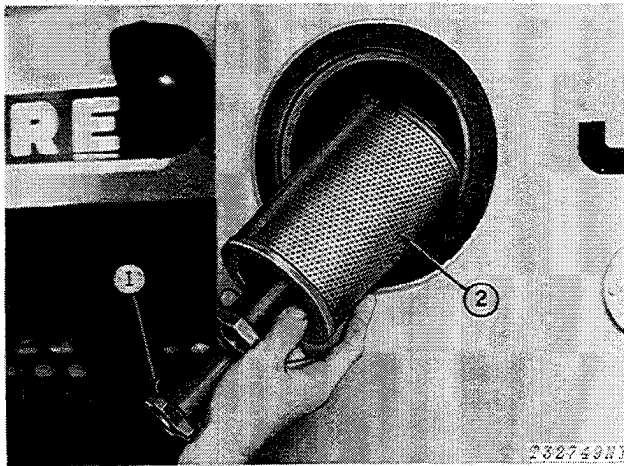

1—Filter Latch 2—Return Filter

Fig. 84-Return Filter

Remove reservoir filler cap to relieve pressure.

Remove reservoir cover. The two return filters are located to the right. Remove by unscrewing the filter latches. Remove snap ring and remove each filter from center tube.

When installing new filters, be sure they are sealed properly and latches are in socket. Turn latches until tight.

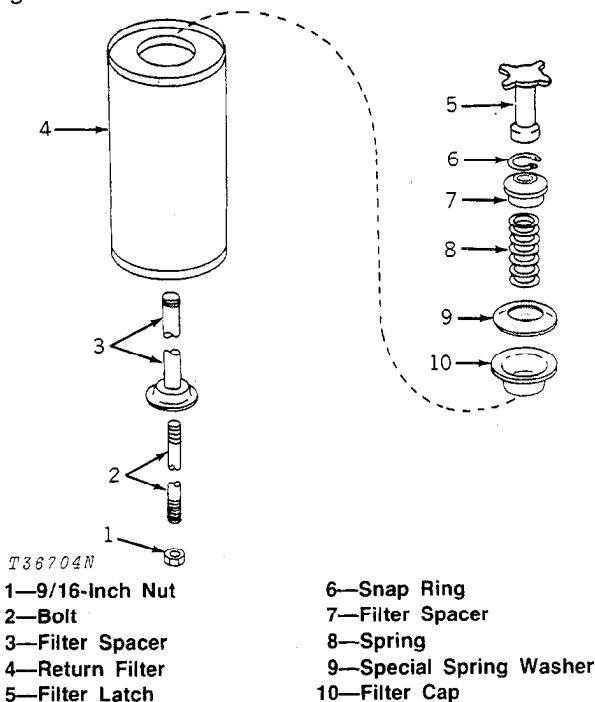
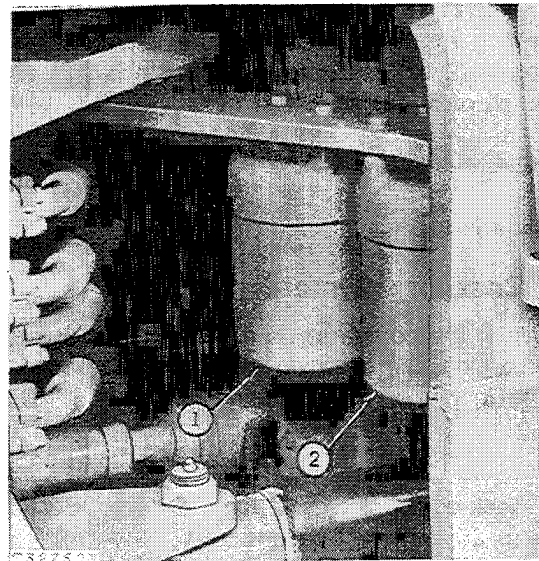

Fig. 85-Exploded View

To insure proper filter engagement turn filter latch until a noticeable change in effort is noted, then hand turn the latch a minimum of 1-1/2 turn more. Additional hand tightening of the latch will not damage the filter.

3. Transmission and Steering Oil Filters



1—Transmission Filter 2—Steering Oil Filter

Fig. 86-Oil Filters

Remove both the transmission and steering return oil filters. Replace both elements and filter cover gaskets. Tighten filter covers to 55 lb-ft (7.6 kg/m).



Suggest:

If the above button click is invalid.

Please download this document

first, and then click the above link

to download the complete manual.

Thank you so much for reading

CHECK ELECTRICAL SYSTEM

1. Batteries

Check battery electrolyte level. If distilled water is not available, use clean soft water. Avoid use of hard water. Remove foreign material from top of battery and coat terminals with petroleum jelly. Clean vent holes in battery caps.

IMPORTANT: Never add water to battery in freezing weather unless engine is to be run long enough (2 or 3 hours) to assure mixing of water and electrolyte.

Batteries checked and serviced

Water added Yes No

2. Charging System

When the compactor is running and the voltmeter is charging, the charging system can be considered to be in proper working condition.

CHECK HYDRAULIC SYSTEM

Check compactor cycle time. Refer to Section 90, Group 25 for specifications.

FLUID LEAKAGE

Check the following systems for leakage due to poor or faulty connections and broken hoses or lines.

- A. Cooling system checked
- B. Hydraulic system checked
- C. Fuel system checked
- D. Lubrication system checked
- E. Air intake system checked
- F. Transmission checked

CHECK TORQUE

1. Wheel Retaining Cap Screws

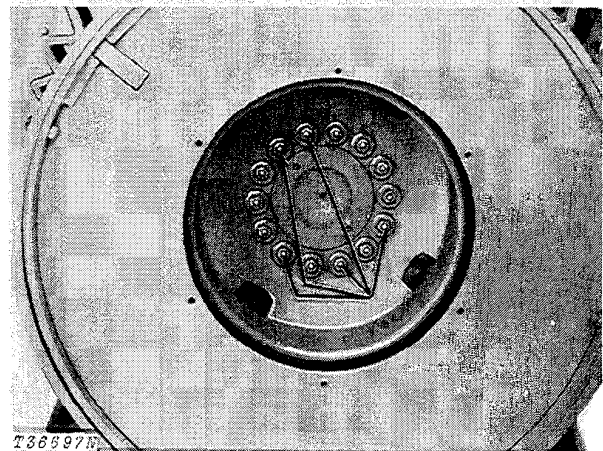

Fig. 87-Wheel Retaining Cap Screws

Check all wheel retainer cap screw torque. Tighten wheel retaining cap screws to 450 lb-ft (62.2 kg/m).

2. Upper Pivot Pin Stop Nut

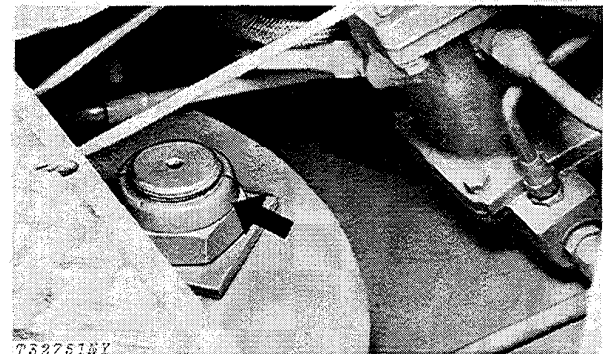

Fig. 88-Upper Pivot Pin Stop Nut

Remove right-hand floor panel. Tighten upper pivot pin stop nut to 1000 lb-ft (138.2 kg/m).

<https://www.ebooklibonline.com>

Hello dear friend!

Thank you very much for reading.

Enter the link into your browser.

The full manual is available for immediate download.

<https://www.ebooklibonline.com>