

# 595 Excavator

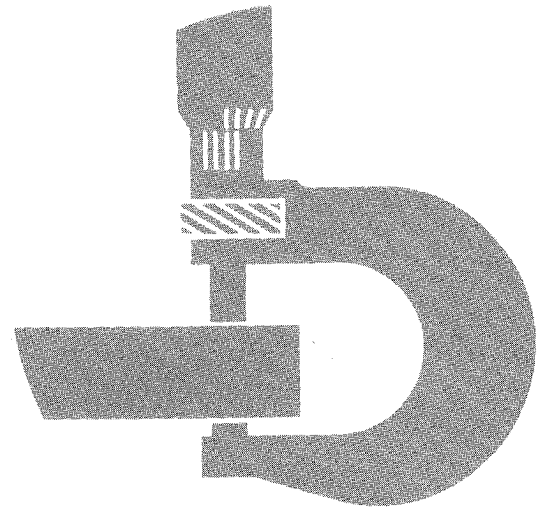

## TECHNICAL MANUAL

**TM1375**  
(OCT-88)  
Litho in U.S.A.

# 595 EXCAVATOR TECHNICAL MANUAL TM-1375 (OCT-88)

## SECTION AND GROUP CONTENTS

### SECTION I—GENERAL INFORMATION

- Group I—Introduction and Safety Information
- Group II—General Specifications
- Group III—Torque Values
- Group IV—Fuels and Lubrication

### SECTION 02—AXLES AND SUSPENSION SYSTEMS

- Group 0200—Removal and Installation
- Group 0210—Differential or Bevel Drive
- Group 0240—Powered Wheel Axle
  - Planetary Hub Reduction,
  - Steering Knuckle Front,
  - and Rear Axle Housings

### SECTION 03—TRANSMISSION

- Group 0300—Removal and Installation
- Group 0350—Gears, Shafts, Bearings and Power Shift Clutch
  - Main Shaft, Bevel Gear,
  - Countershaft, Front Output
  - Shaft, 2WD-to-4WD Shifter, Low to
  - High Range Shifter, Gear Pump and
  - Front and Rear Case.
- Group 0360—Hydraulic System
  - Propel (Transmission Drive),
  - Motor, Brake Valve

### SECTION 04—ENGINE

*NOTE: For engine, 4.5L (276 cu in.), repair, see CTM-4.*

### SECTION 05—ENGINE AUXILIARY SYSTEMS

- Group 0515—Speed Controls
  - Engine Speed Linkage, Speed
  - Control Lever, Fuel Shut-Off
  - Linkage

### SECTION 09—STEERING SYSTEM

- Group 0960—Hydraulic System
  - Steering Valve and Steering
  - Cylinder

### SECTION 10—SERVICE BRAKES

- Group 1011—Active Elements

### SECTION 11—PARK BRAKE

- Group 1111—Active Elements

### SECTION 16—ELECTRICAL SYSTEMS

- Group 1671—Batteries, Support, and Cables
- Group 1672—Alternator, Regulator and Charging System Wiring
- Group 1674—Wiring Harness and Switches
- Group 1676—Instruments and Indicators
- Group 1677—Motors and Actuators

### SECTION 18—OPERATOR'S STATION

- Group 1830—Heating and Air Conditioning
  - Specifications—Air Conditioning

*All information, illustrations and specifications contained in this technical manual are based on the latest information available at the time of publication. The right is reserved to make changes at any time without notice.*

COPYRIGHT® 1988  
DEERE & COMPANY  
Moline, Illinois  
All rights reserved  
A John Deere ILLUSTRATION™ Manual  
Previous Editions  
Copyright® 1986, 1987 Deere & Company

T64;1375 J1 211088

**SECTION 22—PNEUMATIC SYSTEM**

Group 2261—Pump and Drives

Air Compressor, Idle Pulley

Group 2262—Control Valves

Control Valves,  
Relief Valves

Group 2264—Reservoir, Filter, and Trap

Specifications—Air Dryer, Air  
Horn

Group 2265—Cylinders

Specifications—Master Brake  
Cylinder

**SECTION 33—EXCAVATOR**

Group 3315—Controls Linkage

Group 3340—Frames

Specifications—Pivot  
Pins and Bushings

Group 3360—Hydraulic System

Control Valve,  
Cylinders, Axial  
Pumps, Regulator, and  
Hydraulic Reservoir

**SECTION 43—SWING, ROTATION OR PIVOTING SYSTEM**

Group 4360—Hydraulic System

Swing Motor

**SECTION 9005—OPERATIONAL CHECK-OUT PROCEDURE**

**SECTION 9010—ENGINE OPERATION AND TEST**

Group 05—Theory of Operation  
Group 10—System Operational Check  
Group 15—Diagnostic Information  
Group 20—Adjustments  
Group 25—Tests

**SECTION 9015—ELECTRICAL SYSTEM OPERATION AND TEST**

Group 05—Theory of Operation  
Group 10—System Operational Check  
Group 15—Diagnostic Information  
Group 25—Tests

**SECTION 9020—POWER TRAIN OPERATION AND TEST**

Group 05—Theory of Operation  
Group 10—System Operational Check  
Group 15—Diagnostic Information  
Group 20—Adjustments  
Group 25—Tests

**SECTION 9025—HYDRAULIC SYSTEM OPERATION AND TEST**

Group 05—Theory of Operation  
Group 10—System Operational Check  
Group 15—Diagnostic Information  
Group 20—Adjustments  
Group 25—Tests

**SECTION 9030—MISCELLANEOUS COMPONENTS/AIR SYSTEM OPERATION AND TEST**

Group 05—Theory of Operation  
Group 10—System Operational Check  
Group 15—Diagnostic Information  
Group 20—Adjustments  
Group 25—Tests

**SECTION 9031—HEATING AND AIR CONDITIONING OPERATION AND TEST**

Group 05—Theory of Operation  
Group 10—System Operational Check  
Group 20—Adjustments  
Group 25—Tests

**SECTION 99—DEALER FABRICATED TOOLS**

Group 9900—Dealer Fabricated Tools

**<https://www.ebooklibonline.com>**

Hello dear friend!

Thank you very much for reading.

Enter the link into your browser.

The full manual is available for immediate download.

**<https://www.ebooklibonline.com>**

## INTRODUCTION

This manual is part of a total service support program.

### FOS Manuals—reference

### Technical Manuals—machine service

### Component Manuals—component service

*Fundamentals of Service (FOS) Manuals* cover basic theory of operation, fundamentals of troubleshooting, general maintenance, and basic types of failures and their causes. FOS Manuals are for training new personnel and for reference by experienced technicians.

*Technical Manuals* are concise service guides for specific machines. Technical manuals are on-the-job guides containing only the vital information needed by an experienced service technician.

*Component Technical Manuals* are concise service guides for specific components. Component technical manuals are written as stand alone manuals covering multiple machine applications.

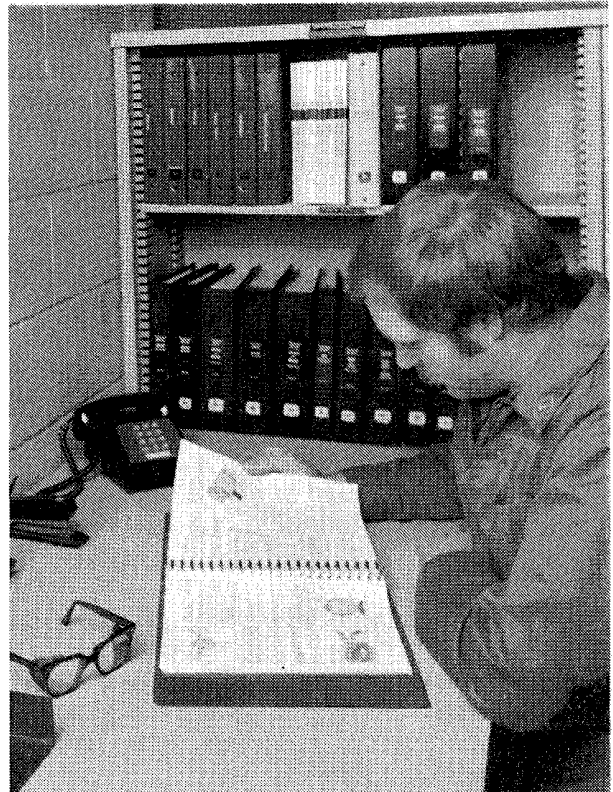

AB6;RW5559 053;INTR02 030785

## FEATURES OF THIS TECHNICAL MANUAL

John Deere ILLUSTRATION format emphasizing illustrations and concise instructions in easy-to-use modules.

Emphasis on diagnosis, analysis, and testing so you can understand the problem and correct it.

Diagnostic information presented with the most logical and easiest to isolate problems first to help you identify the majority of routine failures quickly.

Step-by-step instructions for teardown and assembly.

Summary listing at the beginning of each group of all applicable specifications, wear tolerances, torque values, essential tools, and materials needed to do the job.

An emphasis throughout on safety—so you do the job right without getting hurt.

This technical manual was planned and written for you—an experienced service technician. Keep it in a permanent binder in the shop where it is handy. Refer to it when you need to know correct service procedures or specifications.



AB6;RW5560 053;INTR03 071085

## USING TABS

To fully utilize this technical manual, you must understand how it is organized.

Only two tab colors are used—gray and yellow. Each color represents a different type of information.

Spend a minute reading this now and save many minutes of searching later.

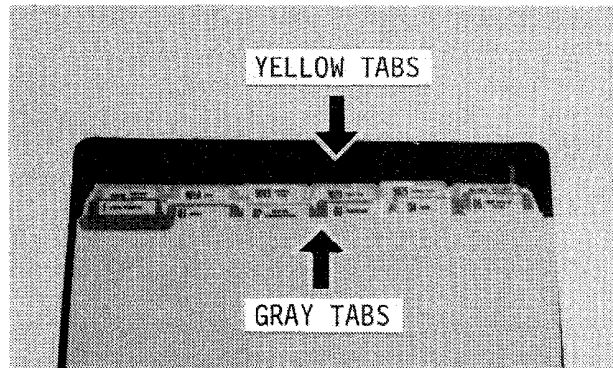

1TA;T5933AB T82;SKPD HE 120984

## GRAY TAB SECTIONS

The gray tab sections are repair sections that tell how to repair the components of the various systems.

Repair of a component includes:

- Removal from machine (when necessary)
- Disassembly
- Inspection
- Replacement of parts
- Assembly
- Adjustment
- Installation on machine (when necessary)

The numbers used for the repair (gray tab) sections are part of an overall service publication numbering system. The numbers identify the same sections in the parts catalog, flat rate manual, service information bulletins, and service training courses.

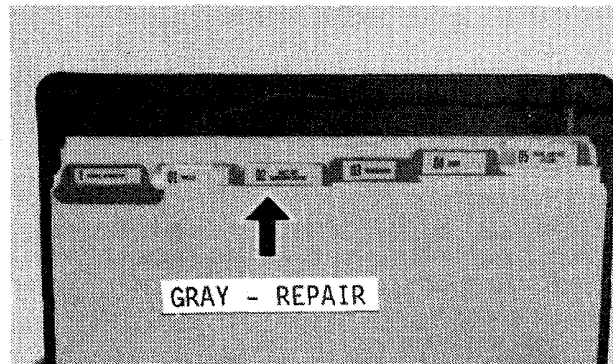

1TA;T5933AC T82;SKPD HF 120984

## YELLOW TAB SECTIONS

Each yellow tab section contains information on:

Groups	
05	Theory of Operation
10	System Operational Checks
15	Diagnostic Information
20	Adjustments
25	Tests

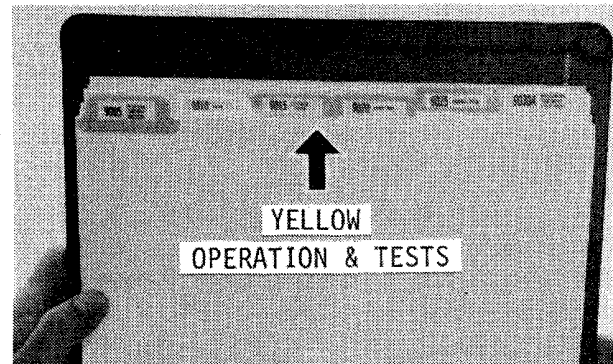

1TA;T5933AD T82;SKPD HG 190984

### THREE-STEP PROCEDURE

Use the following three-step procedure to locate the desired information.

1. Determine the type of information you need. Is it repair, operation, or tests?
2. Go to the appropriate section tab:  
Gray for Repair  
Yellow for Operation or Tests

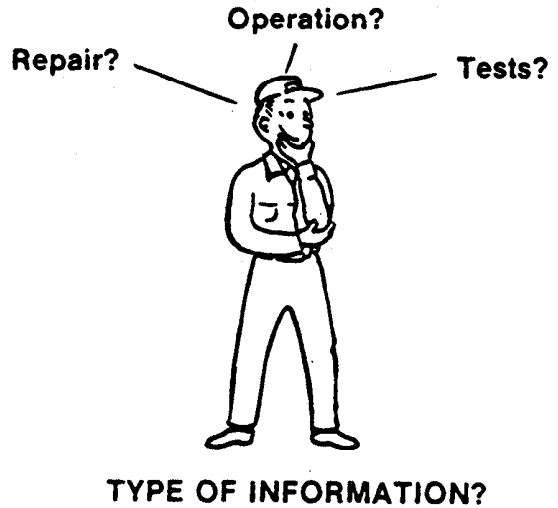

1TA;T5940AT T82;SKPD HI 120984

3. Use the table of contents on the first page of the section to locate the information.

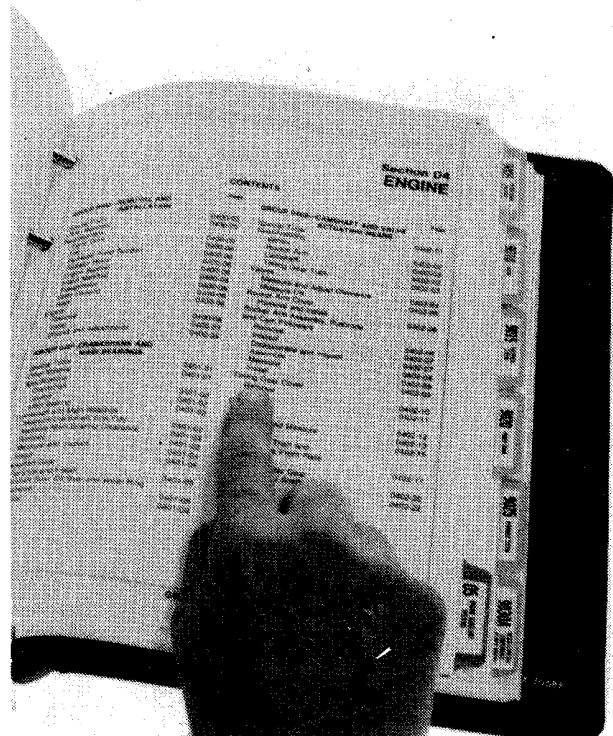

1TA;T5933AF T82;SKPD HJ 140984

## RECOGNIZE SAFETY INFORMATION

This is the safety-alert symbol. When you see this symbol on your machine or in this manual, be alert to the potential for personal injury.



AB6;T81389 053;ALERT 071085

## UNDERSTAND SIGNAL WORDS

A signal word—DANGER, WARNING, or CAUTION—is used with the safety-alert symbol. DANGER identifies the most serious hazards.

Safety signs with signal word DANGER or WARNING are typically near specific hazards.

General precautions are listed on CAUTION safety signs. CAUTION also calls attention to safety messages in this manual.



AB6;TS187 053;SIGNAL 071085

## FOLLOW SAFETY INSTRUCTIONS

Carefully read all safety messages in this manual and on your machine safety signs. Follow recommended precautions and safe operating practices.

Keep safety signs in good condition. Replace missing or damaged safety signs.



AB6;TS188 053;SIGNS 071085

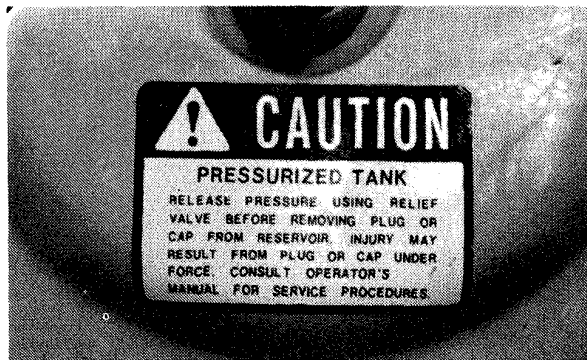

Top of cover on hydraulic reservoir

018;T6256AA 027;05 C2 090186



## CAUTION

1. Refer to operator's manual for safe and proper excavator operation and shipping instructions.
2. Be sure bystanders are clear of excavator before operating unit.
3. Control initial travel movement by engaging foot brake prior to shifting from neutral to F or R.
4. Use caution when moving excavator; both direction and steering movements are reversed when the upper structure is rotated to rear. (Bucket support is on front end of undercarriage.)
5. Use caution to avoid contact between boom and overhead obstacles whenever operating, moving or hauling excavator.
6. Use caution to avoid tipping, lift capacity may exceed machine stability.
7. Before transporting excavator, support bucket on undercarriage in transport position and engage swing lock.
8. **ALWAYS** lower bucket to ground, put forward/reverse lever in neutral, set park brake and stop engine before leaving operator's station.

Lower right corner of right window

018;T6227AG 02T;05 C3 200186



## WARNING



### BRAKE AIR PRESSURE

Low brake air pressure is indicated by indicator light and buzzer.

1. Don't travel until indicator light goes out and buzzer stops.
2. Stop immediately and repair system if light or buzzer comes on during operation.
3. Service brakes will not engage with low air pressure.
4. Parking brake automatically engages with low air pressure. See Operator's Manual for towing instructions.

Right side of cab below lift chart

018;T6231AJ 02T;05 C4 200186

 **WARNING**

**AVOID POSSIBLE INJURY OR DEATH FROM A MACHINE RUNAWAY.**

1. Do not start engine by shorting across starter terminals. Machine will start in gear and move if normal starting circuitry is bypassed.
2. Start engine only from operator's seat with transmission in neutral or park. NEVER start engine while standing on ground.

S

*Cylindrical surface of starter motor so safety message is visible*

018;T6084AZ 02T;05 C5 090186

 **DANGER**

Serious injury or death can result from contact with electric lines. Never move any part of unit or load closer to electric line than 10 feet plus twice the line insulator length.

S

*Left side of left control lever console*

018;T6106AI 02T;05 C6 090186

**CAUTION**

**This filter must not be pressurized over 30 psi as glass may shatter.**

*On top of fuel filter*

018;T7283BG 02T;05 C43 210286

### USE HANDHOLDS AND STEPS

When you get on and off the machine, use handholds and steps.



018;T6192AH T82;BHSA CM 010686

### PREVENT MACHINE RUNAWAY

Avoid possible injury or death from machine runaway.

Do not start engine by shorting across starter terminals. Machine will start in gear if normal circuitry is bypassed.

Start engine only from operator's seat, with travel lever in neutral and park brake engaged.

Do not leave operator's station while engine is running.



AB6;TS177 02T;05 C7 290186

### KEEP RIDERS OFF MACHINE

Only allow the operator on the machine. Keep riders off.

Riders on machine are subject to injury such as being struck by foreign objects and being thrown off of the machine. Riders also obstruct the operator's view resulting in the machine being operated in an unsafe manner.



AB6;TS173 053;RIDER 261184

### PREPARE FOR EMERGENCIES

Be prepared if a fire starts.

Keep a first aid kit and fire extinguishers handy.

Keep emergency numbers for doctors, ambulance service, hospital, and fire department near your telephone.

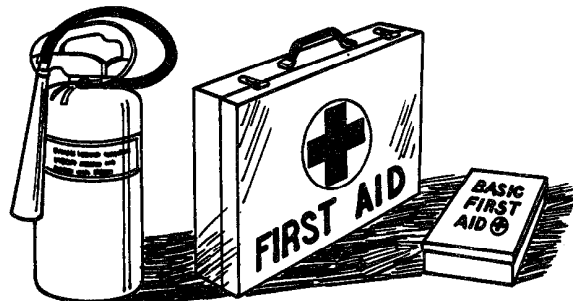

AB6;TS186 053;FIRE2 080785

### HANDLE FUEL SAFELY—AVOID FIRES

Handle fuel with care: it is highly flammable. Do not refuel the machine while smoking or when near open flame or sparks.

Always stop engine before refueling machine. Fill fuel tank outdoors.

Prevent fires by keeping machine clean of accumulated trash, grease, and debris. Always clean up spilled fuel.



AB6;TS185 053;FIRE1 240785

### HANDLE STARTING FLUID SAFELY

Starting fluid is highly flammable.

Keep all sparks and flame away when using it. To prevent accidental discharge when storing the pressurized can, keep the cap on the container, and store in a cool, protected location.

Do not incinerate or puncture a starting fluid container.



AB6;T6089A U 053;FIRE3 080785

### PREVENT BATTERY EXPLOSIONS

Battery gas can explode. Keep sparks and flames away from batteries. Use a flashlight to check battery electrolyte level.

Never check battery charge by placing a metal object across the posts. Use a voltmeter or hydrometer.

Always remove grounded (-) battery clamp first and replace it last.



AB6;TS181 053;EXPLO 180485

## AVOID ACID BURNS

Sulfuric acid in battery electrolyte is poisonous. It is strong enough to burn skin, eat holes in clothing, and cause blindness if splashed into eyes.

Avoid the hazard by:

1. Filling batteries in a well-ventilated area.
2. Wearing eye protection and rubber gloves.
3. Avoiding breathing fumes when electrolyte is added.
4. Avoiding spilling or dripping electrolyte.

If you spill acid on yourself:

1. Flush your skin with water.
2. Apply baking soda or lime to help neutralize the acid.
3. Flush your eyes with water for 10-15 minutes. Get medical attention immediately.

If acid is swallowed:

1. Drink large amounts of water or milk.
2. Then drink milk of magnesia, beaten eggs, or vegetable oil.
3. Get medical attention immediately.

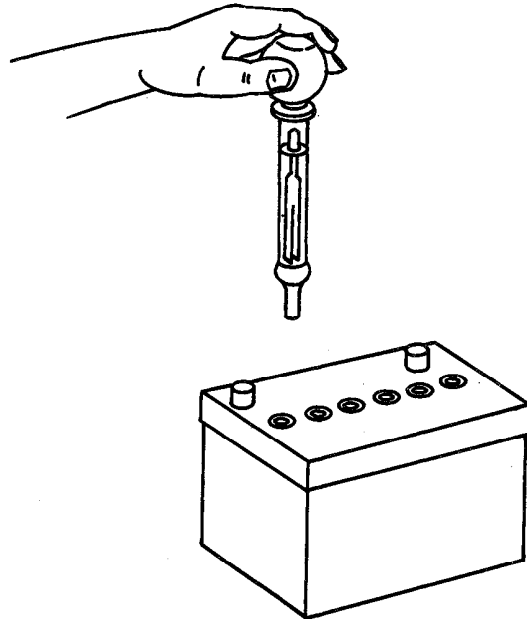

AB6;TS182 053;ACID 180485

## PROTECT AGAINST NOISE

Prolonged exposure to loud noise can cause impairment or loss of hearing.

Wear a suitable hearing protective device such as earmuffs (A) or earplugs (B) to protect against objectionable uncomfortable loud noises.

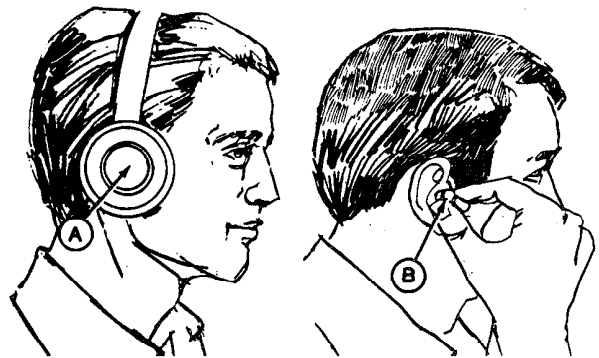

AB6;X7662 053;NOISE 150584

## PROTECT AGAINST FLYING DEBRIS

When you drive connecting pins in or out, guard against injury from flying pieces of metal or debris; wear goggles or safety glasses.

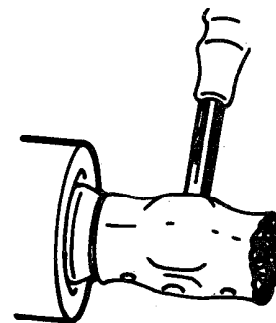

018;T6073AP T82;FLSA AB 130685

### WEAR PROTECTIVE CLOTHING

Wear fairly tight clothing. . . . . and safety equipment.



AB6;T85056 053;WEAR1 080785

### AVOID HIGH-PRESSURE FLUIDS

Escaping fluid under pressure can penetrate the skin causing serious injury. Relieve pressure before disconnecting hydraulic or other lines. Tighten all connections before applying pressure. Keep hands and body away from pinholes and nozzles which eject fluids under high pressure. Use a piece of cardboard or paper to search for leaks.

If ANY fluid is injected into the skin, it must be surgically removed within a few hours by a doctor familiar with this type injury or gangrene may result.

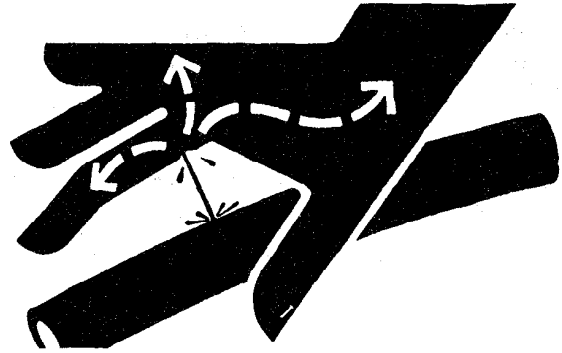

AB6;X9811 053;FLUID 100584

### TEST COOLANT HEATER IN LIQUID ONLY

Do not plug coolant heater into electrical power unless heating element is immersed in coolant. Sheath could burst and result in personal injury.

Use a heavy-duty grounded cord to connect coolant heater to electrical power.

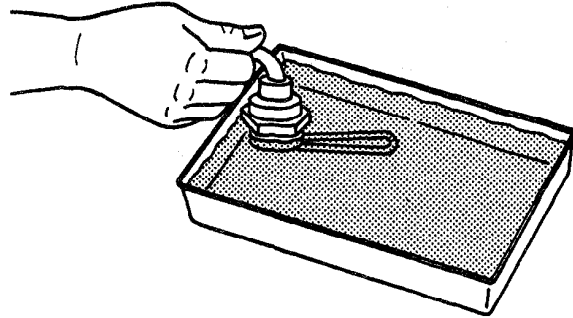

AB6;TS174 053;HEAT 110584

## SERVICE EXCAVATOR SAFELY

Never operate the machine if an unsafe condition exists. Attach a "DO NOT OPERATE" tag to the steering wheel or disconnect the battery ground cable (-) before working on or under the machine.

Be sure you understand a service procedure before working on the machine.

Never lubricate or work on the machine while it is moving.

Always use two people when making checks with the engine running—the operator at the controls, able to see the person doing the checking.

Keep hands away from moving parts.

Never work under a machine raised by the boom. If the machine must be raised, keep a 90—110° angle between boom and arm.

Do not work under a raised bucket. Lower bucket to ground or onto blocks.

Disconnect battery ground cable (-) before welding on the machine or making adjustments on the engine or electrical system.

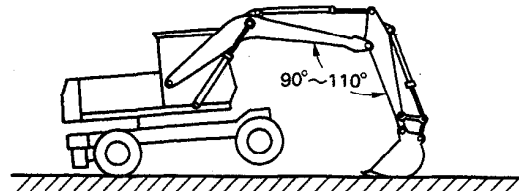

018;T6133AH, T6249AR 02T;05 C12 300186

## SERVICE TIRES SAFELY

Failure to follow proper procedures when mounting a tire on a wheel or rim can produce an explosion which may result in serious injury or death. Do not attempt to mount a tire unless you have the proper equipment and experience to perform the job. Have it done by your John Deere dealer or a qualified repair service.

Detailed tire mounting instructions, including necessary safety precautions, are contained in John Deere Fundamentals of Service (FOS) Manual 55. Tires and Tracks, available through your John Deere dealer. Such information is also available from the Rubber Manufacturers Association and from tire manufacturers.

- A—Use a Safety Cage if Available
- B—Do Not Stand Over Tire—Use a Clip-on Chuck and Extension Hose

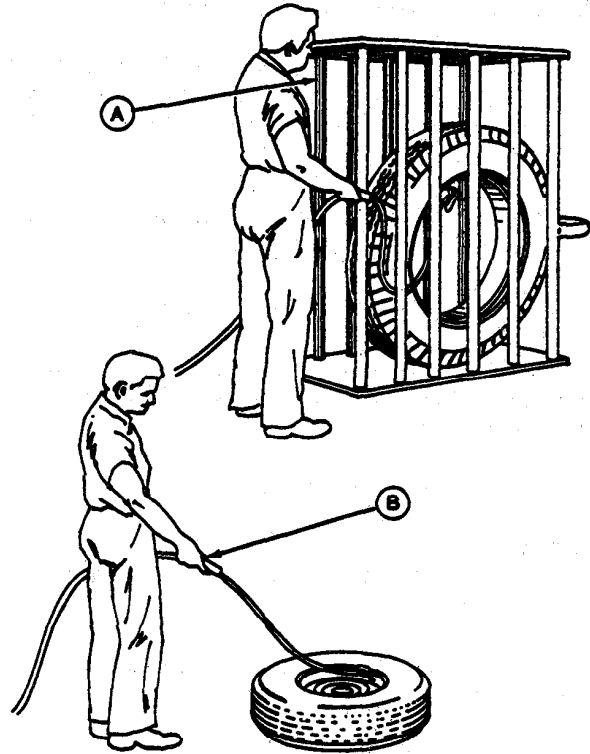

AB6;TS0123 053;TIRE2 110584



*Specifications*

*(Specifications and design subject to change without notice. Wherever applicable, specifications are in accordance with PCSA and SAE standards. Except where otherwise noted, these specifications are based on a unit with full fuel tank, 80 kg [175 lb] operator, and standard equipment.)*

**Engine:**

John Deere 4-cylinder turbocharged diesel ..... 71 SAE net kW (95 hp)  
 Bore and stroke ..... 106.5 x 127 mm (4.19 x 5 in.)  
 No. of cylinders ..... 4  
 Piston displacement ..... 4.5 L (276 cu. in.)  
 Lubrication ..... Pressure system with full-flow filter  
 Cooling fan ..... Suction  
 Electrical system ..... 24-volt with 42 amp alternator

Transmission ..... Constant mesh with high and low speed range

Drive system ..... 4 x 4 (low speed range) and 4 x 2 (high speed range)

**Travel speeds:**

F1 Low ..... 0—4.5 km/h (0—2.8 mph)  
 F1 High ..... 0—15 km/h (0—9.3 mph)  
 F2 Low ..... 0.9 km/h (0—5.6 mph)  
 F2 High ..... 0—30 km/h (0—18.6 mph)  
 R (Low Only) ..... 0—4.5 km/h (0—2.8 mph)

**Brakes:**

Service (foot pedal or switch) ..... Air over hydraulic brakes acting at each wheel,  
 internal expanding shoe type  
 Park (switch) ..... Spring actuated, air-released internal expanding shoe type

**Axles:**

Front ..... Oscillating axle (14° total oscillation) with locking hydraulic cylinders  
 Rear ..... Fixed to frame

**Hydraulic system (open center, variable flow):**

Hydraulic system relief ..... 29 414 kPa (294 bar) (4266 psi)  
 Travel circuit relief ..... 30 400 kPa (304 bar) (4409 psi)  
 Boom circuit relief ..... 25 988 kPa (260 bar) (3770 psi)  
 Arm circuit relief ..... 25 988 kPa (260 bar) (3770 psi)  
 Bucket circuit relief ..... 25 988 kPa (260 bar) (3770 psi)  
 Swing motor circuit relief ..... 20 588 kPa (206 bar) (2986 psi)  
 Stabilizers circuit relief ..... 24 517 kPa (245 bar) (3556 psi)

**Main hydraulic pumps (two variable-displacement axial piston):**

Pressure setting ..... 29 420 kPa (294 bar) (4267 psi)  
 Maximum oil flow ..... 2 x 183 L/min (2 x 48.3 gpm)

**Pilot pump (gear pump):**

Pressure setting ..... 3628 kPa (36 bar) (526 psi)  
 Maximum oil flow ..... 9.6 L/min (2.54 gpm)

**Steering pump (gear pump):**

Pressure setting ..... 12 258 kPa (123 bar) (1778 psi)  
 Maximum oil flow ..... 31.6 L/min (8.35 gpm)

05T;115 C3 300186

**Group III  
TORQUE VALUES**

**HARDWARE TORQUE SPECIFICATIONS**



Check cap screws and nuts to be sure they are tight. If hardware is loose, tighten to torque shown on the following charts unless a special torque is specified.

T82;SKMA AT 270286

*NOTE: Torques shown are for dry (no lubrication on threads) hardware.*

*NOTE: Torque wrench tolerance is ± 10 per cent of specified torque.*

Customary Hardware

Cap Screw Size-Inches	Grade B 		Grade D 		Grade F 	
	lb-ft.	(N-m)	lb-ft.	(N-m)	lb-ft.	(N-m)
1/4	----	----	10	(14)	14	(19)
5/16	----	----	20	(27)	30	(41)
3/8	----	----	35	(47)	50	(68)
7/16	35	(47)	55	(75)	80	(108)
1/2	55	(75)	85	(115)	120	(163)
9/16	75	(102)	130	(176)	175	(237)
5/8	105	(142)	170	(230)	240	(325)
3/4	185	(251)	300	(407)	425	(576)
7/8	160	(217)	445	(603)	685	(929)
1	250	(339)	670	(908)	1030	(1396)
1-1/8	330	(447)	910	(1234)	1460	(1979)
1-1/4	480	(651)	1250	(1695)	2060	(2793)

018;T88894 T82;FLMA AJ 140685

**CHECK WHEEL CAP SCREW TORQUE**

**SPECIFICATIONS**

Wheel cap screw torque ..... 441—541 N-m  
(325—399 lb-ft)

04T;90 C18 230186

## Torque Values

### Bolt Tightening Torque

Bolts are classified into three kinds according to their materials.



T-BOLT



H-BOLT



M-BOLT

Unit: Nm (lb-ft)

Nominal dia(mm)	8	10	12	14	16	18	20	22	24	27	30	33	36
Kind													
T-BOLT	29 (21)	63 (46)	108 (80)	176 (130)	265 (195)	392 (289)	539 (398)	735 (542)	931 (687)	1372 (1012)	1911 (1410)	2548 (1880)	3136 (2314)
H-BOLT	20 (15)	45 (33)	88 (65)	137 (101)	206 (152)	294 (217)	392 (289)	539 (398)	686 (506)	1029 (759)	1421 (1048)	1911 (1410)	2401 (1772)
M-BOLT	10 (7)	20 (15)	34 (25)	54 (40)	78 (58)	118 (87)	167 (125)	216 (159)	274 (202)	392 (289)	539 (398)	735 (542)	931 (687)

(Tolerance: ±10%)

### Flared Type Joint Tightening Torque

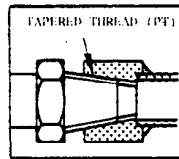

TAPERED THREAD

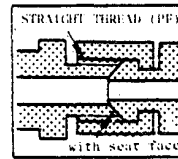

STRAIGHT THREAD  
(with seat face)

Unit: Nm (lb-ft)

THREAD (inch)	1/8	1/4	3/8	1/2	3/4	1	1-1/4	1-1/2	2
KIND OF THREAD									
TAPERED THREAD	15 (11)	20 (15)	29 (21)	49 (36)	69 (51)	108 (80)	157 (116)	196 (145)	255 (188)
STRAIGHT THREAD	—	45 (33)	69 (51)	93 (69)	176 (130)	206 (152)	343 (253)	539 (398)	588 (434)

(Tolerance: ±10%)

Note: If female thread is of cast iron (in case of control valves, brake valve motors etc.), the torque must be reduced by about 10%.

*Torque Values*

### METRIC HARDWARE TORQUE CHART

*NOTE: Torques shown are for hardware with SAE30W oil on threads.*

*NOTE: Torque wrench tolerance is  $\pm 10$  percent of specified torque.*

**Metric Standard Thread**

Thread	8.8		10.9		12.9	
	N·m	(lb-ft)	N·m	(lb-ft)	N·m	(lb-ft)
M5	5.9	( 4.4)	7.9	( 5.8)	9.8	( 7.2)
M6	9.8	( 7.2)	13.8	( 10.2)	16.7	( 12.3)
M8	24.6	( 18.1)	34.4	( 25.4)	40.2	( 29.6)
M10	48.1	( 35.5)	67.8	( 50.0)	81.5	( 60.1)
M12	84.4	( 62.2)	118.0	( 87.0)	142.0	(105.0)
M14	133.0	( 98.0)	187.0	(138.0)	226.0	(167.0)
M16	206.0	(152.0)	290.0	(214.0)	348.0	(257.0)
M18	285.0	(210.0)	398.0	(294.0)	476.0	(351.0)
M20	402.0	(296.0)	570.0	(420.0)	677.0	(499.0)
M22	540.0	(398.0)	765.0	(564.0)	914.0	(674.0)
M24	697.0	(514.0)	980.0	(723.0)	1180.0	(870.0)

**Metric Fine Thread**

Thread	8.8		10.9		12.9	
	N·m	(lb-ft)	N·m	(lb-ft)	N·m	(lb-ft)
M8 x 1	26.5	( 19.5)	37.3	( 27.5)	44.2	( 32.6)
M10 x 1	47.1	( 34.7)	68.8	( 50.7)	81.5	( 60.1)
M12 x 1.5	88.4	( 65.2)	123.0	( 91.0)	147.0	( 108.0)
M14 x 1.5	147.0	(108.0)	206.0	( 152.0)	246.0	( 181.0)
M16 x 1.5	221.0	(163.0)	309.0	( 228.0)	373.0	( 275.0)
M18 x 1.5	319.0	(235.0)	451.0	( 333.0)	540.0	( 398.0)
M20 x 1.5	451.0	(333.0)	628.0	( 463.0)	755.0	( 557.0)
M22 x 1.5	599.0	(442.0)	845.0	( 623.0)	1030.0	( 760.0)
M24 x 2	765.0	(564.0)	1080.0	( 796.0)	1275.0	( 940.0)
M26 x 2	1130.0	(833.0)	1570.0	(1158.0)	1915.0	(1412.0)

T82;EXMA T 200286

**HYDRAULIC FLANGED CONNECTIONS  
(HIGH PRESSURE SERIES)**

1. Inspect the sealing surfaces for nicks or scratches, roughness or out-of-flat condition. Scratches cause leaks. Roughness causes seal wear. Out-of-flat causes seal extrusion. If these defects cannot be polished out, replace the component.
2. Install the correct O-ring (and backup washer if required) into the groove using petroleum jelly to hold it in place.
3. For split flange; loosely assemble split flange halves, being sure that the split is centrally located and perpendicular to the port. Hand tighten cap screws to hold parts in place. Do not pinch O-ring.
4. For single piece flange; put hydraulic line in the center of the flange and install four cap screws. With the flange centrally located on the port, hand tighten cap screws to hold it in place. Do not pinch O-ring.
5. For both single piece flange and split flange, be sure the components are properly positioned and cap screws are hand tight. Tighten one cap screw, then tighten the diagonally opposite cap screw. Tighten the two remaining cap screws. Tighten all cap screws within the specified limits shown in the chart.

DO NOT use air wrenches. DO NOT tighten one cap screw fully before tightening the others. DO NOT overtighten.

**Metric Standard Thread**

Thread	N·m	(lb-ft)
M6	12	9
M8	30	22
M10	57	42
M12	95	70
M14	157	116
M16	217	160
M18	334	246
M20	431	318

*NOTE: Tolerance  $\pm 10\%$ . The torques given are enough for the given size connection with the recommended working pressure. Increasing cap screw torque beyond these amounts will result in flange and cap screw bending and connection failures.*

T82;EXMA BY 110684

**SERVICE RECOMMENDATIONS FOR 37° FLARE AND 30° CONE SEAT CONNECTORS**

1. Inspect the flare and the flare seat. They must be free of dirt or obvious defects.
2. Defects in the tube flare cannot be repaired. Overtightening a defective flared fitting will not stop leaks.
3. Align the tube with the fitting before attempting to start the nut.
4. Lubricate the male threads with hydraulic fluid or petroleum jelly.
5. Index angle fittings and tighten by hand.
6. Tighten fitting or nut to torque value shown on the chart. Do not allow hoses to twist when tightening fittings.

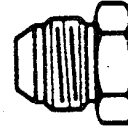

**STRAIGHT FITTING OR SPECIAL NUT TORQUE**

Thread Size	Torque N·m	(lb-ft)
3/8-24 UNF .....	8 .....	(6)
7/16-20 UNF .....	12 .....	(9)
1/2-20 UNF .....	16 .....	(12)
9/16-18 UNF .....	24 .....	(18)
3/4-16 UNF .....	46 .....	(34)
7/8-14 UNF .....	62 .....	(46)
1-1/16-12 UN .....	102 .....	(75)
1-3/16-12 UN .....	122 .....	(90)
1-5/16-12 UN .....	142 .....	(105)
1-5/8-12 UN .....	190 .....	(140)
1-7/8-12 UN .....	217 .....	(160)

*NOTE: Torque tolerance is ± 10%.*

018;T6234AC T82;BHMA EL 031285

## SERVICE RECOMMENDATIONS FOR O-RING BOSS FITTINGS

### Straight Fitting

1. Inspect O-ring boss seat for dirt or defects.
2. Lubricate O-ring with petroleum jelly. Place electrical tape over threads to protect O-ring. Slide O-ring over tape and into O-ring groove of fitting. Remove tape.
3. Tighten fitting to torque value shown on chart.

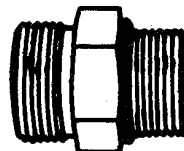

### Angle Fitting

1. Back-off lock nut (A) and back-up washer (B) completely to head-end (C) of fitting.
2. Turn fitting into threaded boss until back-up washer (B) contacts face of boss.
3. Turn fitting head-end (C) counterclockwise to proper index (maximum of one turn).
4. Hold fitting head-end (C) with a wrench and tighten locknut (A) and back-up washer (B) to proper torque value.

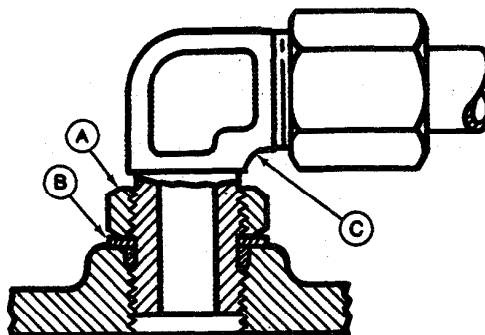

**NOTE:** Do not allow hoses to twist when tightening fittings.

**TORQUE VALUE CHART**

Thread Size	Torque N-m	(lb-ft)
3/8-24 UNF	8	(6)
7/16-20 UNF	12	(9)
1/2-20 UNF	16	(12)
9/16-18 UNF	24	(18)
3/4-16 UNF	46	(34)
7/8-14 UNF	62	(46)
1-1/16-12 UN	102	(75)
1-3/16-12 UN	122	(90)
1-5/16-12 UN	142	(105)
1-5/8-12 UN	190	(140)
1-7/8-12 UN	217	(160)

**NOTE:** Torque tolerance is  $\pm 10\%$ .

## Group IV FUELS AND LUBRICANTS

### FUEL SPECIFICATIONS

Use ONLY clean, high-quality fuel.

Use Grade No. 2-D fuel above 4°C (40°F).

Use Grade No. 1-D fuel below 4°C (40°F).

Use Grade No. 1-D fuel for all air temperatures at altitudes above 1 500 m (5000 ft).

**IMPORTANT: If fuel sulfur content exceeds 0.5 per cent, the engine oil drain interval must be reduced by 50 per cent (to 125 hours).**

**Use fuel with less than 1.0 per cent sulfur. If possible, use fuel with less than 0.5 per cent sulfur.**

For maximum filter life, sediment and water should not be more than 0.10 per cent.

The cetane number should be 40 minimum. If you operate your machine where air temperatures are normally low or where altitudes are high, you may need fuel with a higher cetane number.

Cloud Point—For cold weather operation, cloud point should be 6°C (10°F) below lowest normal air temperature.

T82;BHFL F 261285

### FUEL STORAGE

*NOTE: Diesel fuels stored for a long time may form gum or bacteria and plug filters.*

Keep fuel in a clean container in a protected area. Water and sediment must be removed before fuel gets to the engine. Do not use de-icers to remove water from fuel. Do not depend on fuel filters to remove water.

If possible, install a water separator at the storage tank outlet. (See your John Deere dealer).

**IMPORTANT: Keep all dirt, scale, water or other foreign material out of fuel.**

Store fuel drums on their sides with plug up.

T82;BHFL G 290186

**ENGINE OIL**

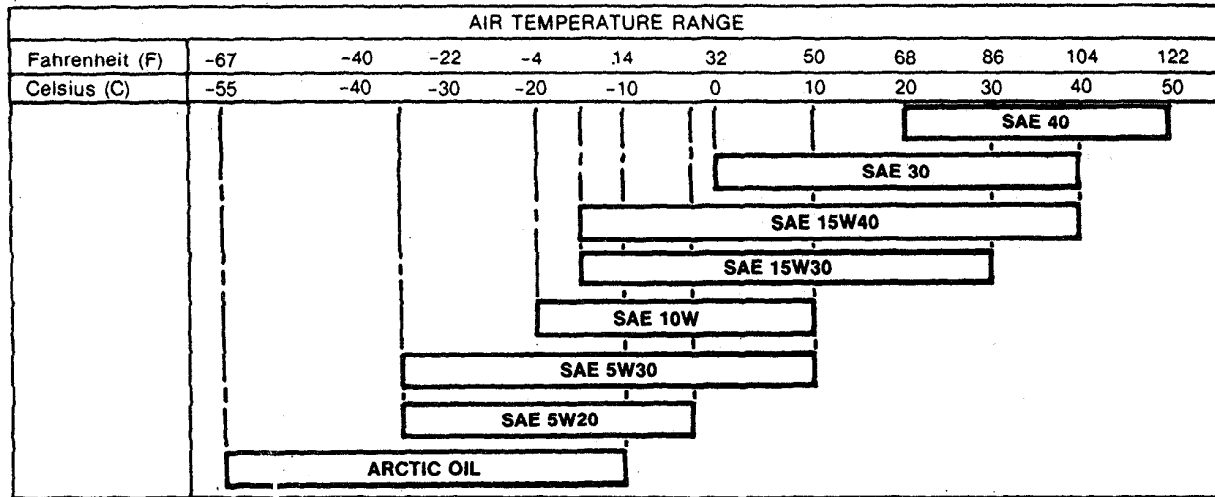

Depending upon the expected air temperature range between oil changes, use oil viscosity shown on the temperature chart above.

Additives are not required nor recommended.

John Deere TORQ-GARD SUPREME® engine oil is recommended. If other oils are used, they must have the following minimum specifications:

Oil Specification	Use
API Service CD/SC (MIL-L-2104C)	Recommended.
API Service CC/SC* or MIL-L-46152*	For SAE 5W20, SAE 5W30 and arctic oil only, use if recommended oil is not available.
MIL-L-46167*	For arctic oil only.
*Change oil at 125 hours, which is half the normal drain interval.	

018;T6172AI T82;EXFL Z 270286



**SWING GEARBOX, TRANSMISSION, AXLES, AND WHEEL GEAR REDUCTION OIL**

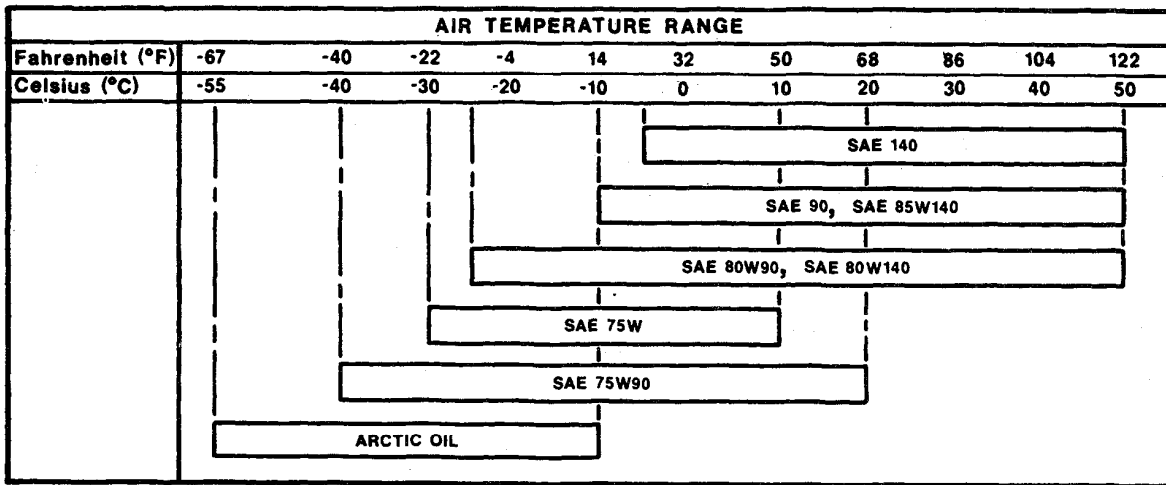

Depending on the expected air temperature range between oil changes, use oil viscosity shown on the temperature chart above.

The following oils are recommended:

John Deere API GL-5 Gear Oil

Oils meeting API Service GL-5 (MIL-L-2105B or MIL-2105C)

Oil meeting MIL-L-10324A may be used as arctic oil.

018;T6247AB 02T;45 C3 290186

**BRAKE OIL**

Use oil meeting SAE 1703F.

02T;45 C4 200186



## **COLD WEATHER OPERATION**

Additional information on cold weather operation is available from your John Deere Industrial Region office.

T82;TLPD U 270183

## **ALTERNATIVE LUBRICANTS**

Conditions in certain geographical areas may require special lubricants and lubrication practices which do not appear in this manual. If you have any questions, consult your John Deere Industrial Region office to obtain the latest information and recommendations.

T82;TLPD Y 270183

## **LUBRICANT STORAGE**

Your machine can operate at top efficiency only if clean lubricants are used. Use clean containers to handle all lubricants. Store them in an area protected from dust, moisture, and other contamination. Store drums on their sides.

T82;BHFL J 080483

# Section 02

# AXLES AND SUSPENSION SYSTEM

## CONTENTS

	Page
<b>GROUP 0200—Removal And Installation</b>	
Service Equipment and Tools .....	0200-1
Specifications .....	0200-1
Front Axle	
Remove and Install .....	0200-2
Rear Axle	
Remove and Install .....	0200-3
<b>GROUP 0210—Differential Or Bevel Drive</b>	
Service Equipment and Tools .....	0210-1
Other Materials .....	0210-1
Specifications .....	0210-2
Differential	
Disassemble .....	0210-3
Assemble .....	0210-7
<b>GROUP 0240—Powered Wheel Axle</b>	
Service Equipment and Tools .....	0240-1
Other Materials .....	0240-1
Specifications .....	0240-2
Hub Reduction	
Disassemble .....	0240-3
Assemble .....	0240-7
Knuckle and Steering Arm	
Disassemble .....	0240-11
Assemble .....	0240-13
Front Axle Housing	
Disassemble and Assemble .....	0240-17



## Group 0200 Removal and Installation

### SERVICE EQUIPMENT AND TOOLS

*NOTE: Order tools from your SERVICE-GARD™ Catalog. Some tools may be available from a local supplier.*

Name	Use
Lifting Sling	To remove and install front axle assembly.
Low Lift Transmission Jack Universal Mounting Arm	To remove and install rear axle assembly.
10-Ton Jack Stands	To support machine for axle removal.

/0200 BB1 030487

### SPECIFICATIONS

Item	Measurement	Specification
Axle-to-Frame Cap Screw and Nuts .....	Torque .....	.931 N·m (687 lb-ft)
Drive Shaft-to-Axle Cap Screws ...	Torque .....	.76 N·m (56 lb-ft)
Wheel Lug Nuts .....	Torque .....	.491 N·m (362 lb-ft)
Steering Cylinder Rod-to-Arm Nut .....	Torque .....	.542 N·m (400 lb-ft)

/0200 BB2 030487

## REMOVE AND INSTALL FRONT AXLE

1. Raise machine and put 10-ton shop stands under frame.
2. Disconnect battery cable.
3. Remove fenders.

*NOTE: Left side wheel lug nuts have left hand threads.*

4. Remove wheels.
5. Remove steering cylinders from frame and steering arms.
6. Disconnect drive shaft.

**⚠ CAUTION:** Escaping fluid under pressure can penetrate the skin causing serious injury. Relieve pressure before disconnecting hydraulic or other lines. Tighten all connections before applying pressure. Keep hands and body away from pinholes and nozzles which eject fluids under high pressure. Use a piece of cardboard to search for leaks. Do not use your hand.

If ANY fluid is injected into the skin, it must be surgically removed within a few hours by a doctor familiar with this type injury or gangrene may result.

7. Disconnect brake hoses. Close openings using caps and plugs.

**⚠ CAUTION:** The approximate weight of axle assembly is 950 kg (2100 lb).

8. Connect axle to a hoist. Remove axle-to-frame nuts and cap screws to remove axle.
9. Before installing axle assembly, clean all mounting surfaces, cap screws, and nuts.

### TORQUE SPECIFICATIONS

Axle-to-Frame Cap Screw and Nuts	980 N·m (723 lb-ft)
Drive Shaft-to-Axle Cap Screws	76 N·m (56 lb-ft)
Wheel Lug Nuts	491 N·m (362 lb-ft)
Steering Cylinder Rod-to-Arm Nuts	542 N·m (400 lb-ft)

10. Bleed brake cylinders.

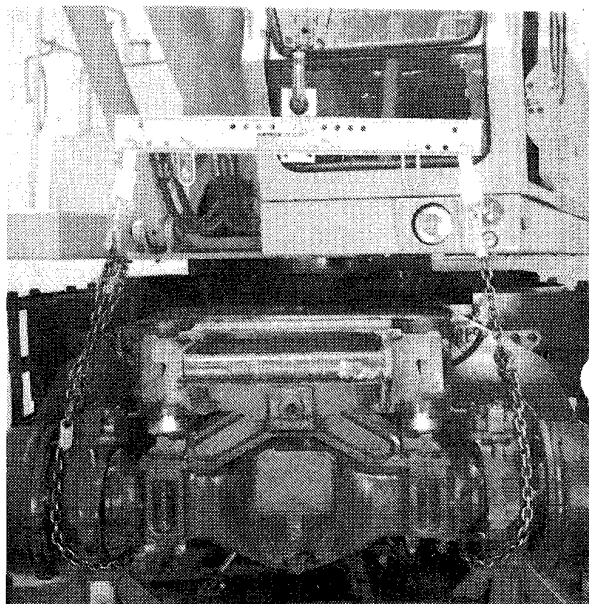

/T6460DJ /0200 BB3 030487

## REMOVE AND INSTALL REAR AXLE

1. Raise machine and put 10-ton shop stands under frame.
2. Disconnect battery cable.

*NOTE: Left side wheel lug nuts have left hand threads.*

3. Remove wheels.
4. Disconnect drive shaft.

**CAUTION: Escaping fluid under pressure can penetrate the skin causing serious injury. Relieve pressure before disconnecting hydraulic or other lines. Tighten all connections before applying pressure. Keep hands and body away from pinholes and nozzles which eject fluids under high pressure. Use a piece of cardboard to search for leaks. Do not use your hand.**

**If ANY fluid is injected into the skin, it must be surgically removed within a few hours by a doctor familiar with this type injury or gangrene may result.**

5. Disconnect brake hoses. Close openings using caps and plugs.

**CAUTION: The approximate weight of axle assembly is 770 kg (1700 lb).**

6. Fasten low lift transmission jack to axle using universal mount arms.
7. Remove axle-to-frame nuts and cap screws to remove axle.
8. Before installing axle assembly, clean all mounting surfaces, cap screws, and nuts.

### TORQUE SPECIFICATIONS

Axle-to-Frame Cap Screw Nuts ..... 980 N·m (723 lb-ft)  
Drive Shaft-to-Axle Cap Screws ..... 76 N·m (56 lb-ft)

9. Bleed brake cylinders.

/0200 BB4 030487

*Removal and Installation*

**Group 0210**  
**Differential on Bevel Drive**

**SERVICE EQUIPMENT AND TOOLS**

*NOTE: Order tools from your SERVICE-GARD™ Catalog. Some tools may be available from a local supplier.*

<b>Name</b>	<b>Use</b>
Spring Scale	To measure bearing rolling drag torque

/0210 AA1 030487

**OTHER MATERIALS**

<b>Number</b>	<b>Name</b>	<b>Use</b>
TY 9371	High Strength Thread Lock and Sealer	Ring Gear Cap Screws
TY 6304	Flexible Sealant	Carrier to Axle Housing

/0210 AA2 030487

*Differential on Bevel Drive*

**SPECIFICATIONS**

Item	Measurement	Specification
Differential Pinion Gears to Spider .....	Clearance .....	0.1 mm (0.004 in.)
	Wear Limit .....	0.2 mm (0.008 in.)
Differential Gears to Cage Bore ...	Clearance .....	0.03 mm (0.0012 in.)
	Wear Limit .....	0.09 mm (0.0035 in.)
Pinion Shaft Bearing Preload .....	Force .....	3.8—4.5 kg (8.4—9.9 lb)
Ring Gear-to-Cage Cap Screws .....	Torque .....	208 N·m (153 lb-ft)
Pinion Gear-to-Ring Gear Cap Screws .....	Torque .....	151 N·m (112 lb-ft)
Differential Gear to Cage .....	Clearance .....	0.03—0.09 mm (0.001—0.003 in.)
Bearing Cap-to-Carrier Housing Cap Screws .....	Torque .....	151 N·m (112 lb-ft)
Carrier Housing Bearing Adjusting Nuts .....	Torque .....	47 N·m (35 lb-ft)
Ring Gear Cage and Pinion Gear Cage Bearings Preload .....	Force .....	2.4—2.8 kg (5.3—6.2 lb)
Ring Gear .....	Runout .....	0.00—0.09 mm (0.000—0.0035 in.)
	Service Limit .....	0.2 mm (0.008 in.)
Pinion Housing to Carrier Housing Cap Screws .....	Torque .....	79 N·m (59 lb-ft)
Ring Gear to Pinion Gear Backlash .....	Clearance .....	0.25—0.33 mm (0.010—0.013 in.)
Carrier-to-Axle Housing Cap Screws .....	Torque .....	48 N·m (36 lb-ft)
Axle Housing Oil .....	Capacity:	
	Front .....	6.9 L (7.3 qt)
	Rear .....	10.2 L (10.6 qt)

/0210 AA3 030487

**DISASSEMBLE DIFFERENTIAL**

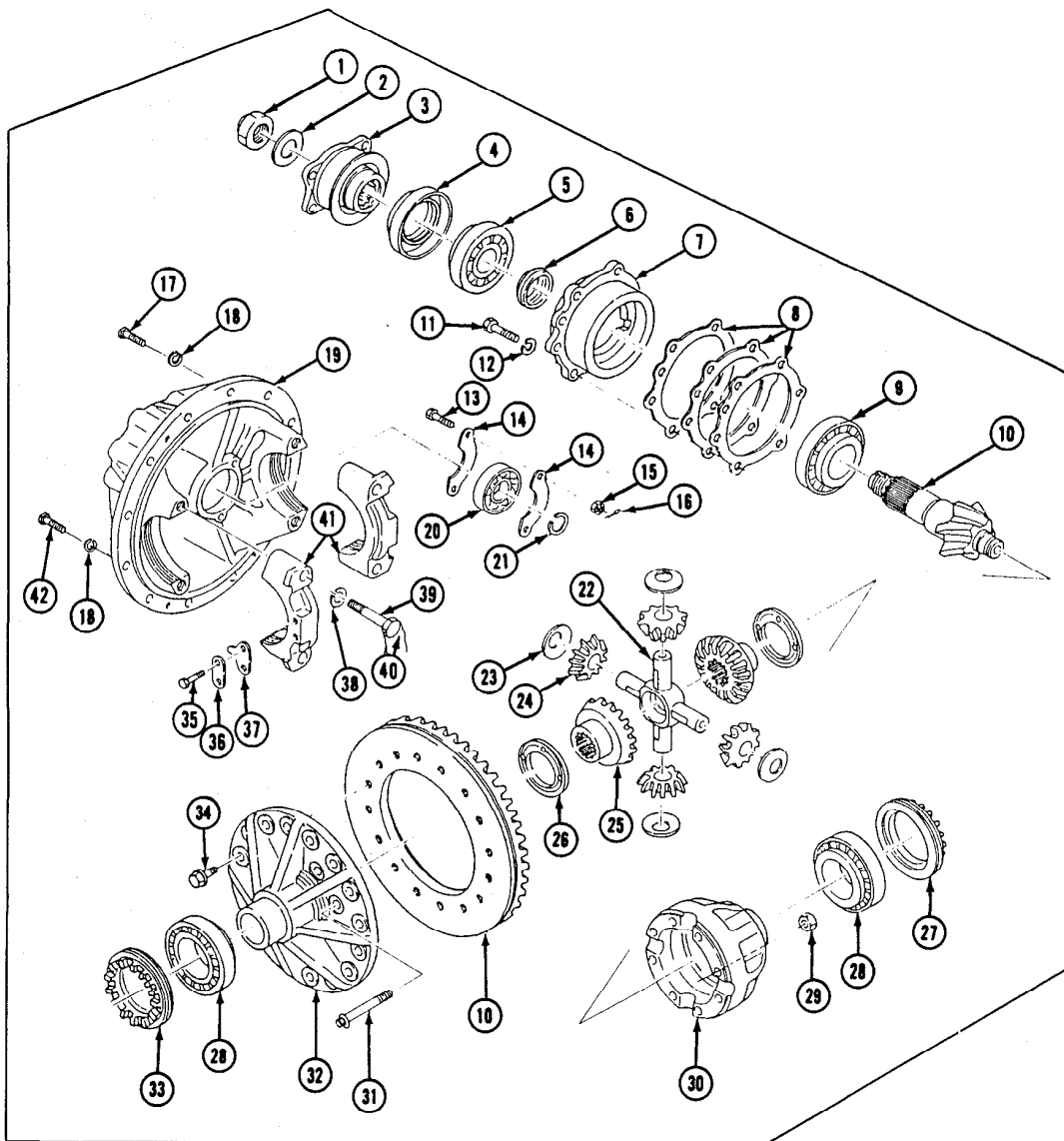

- |                                  |                          |                           |                         |
|----------------------------------|--------------------------|---------------------------|-------------------------|
| 1—Lock Nut                       | 12—Lock Washer (6 used)  | 22—Spider                 | 32—Cage                 |
| 2—Washer                         | 13—Cap Screw (2 used)    | 23—Thrust Washer (4 used) | 33—Nut                  |
| 3—Flange                         | 14—Retainer (2 used)     | 24—Pinion (4 used)        | 34—Cap Screw (16 used)  |
| 4—Seal                           | 15—Nut (2 used)          | 25—Gear (2 used)          | 35—Cap Screw (4 used)   |
| 5—Bearing                        | 16—Cotter Pin (2 used)   | 26—Washer                 | 36—Strap (2 used)       |
| 6—Spacer                         | 17—Cap Screw (4 used)    | 27—Nut                    | 37—Plate (2 used)       |
| 7—Cage                           | 18—Lock Washer (12 used) | 28—Bearing (2 used)       | 38—Lock Washer (4 used) |
| 8—Shim                           | 19—Carrier               | 29—Nut (8 used)           | 39—Cap Screw (4 used)   |
| 9—Bearing                        | 20—Bearing               | 30—Cage                   | 40—Wire (2 used)        |
| 10—Ring Gear And Pinion<br>Shaft | 21—Snap Ring             | 31—Cap Screw (8 used)     | 41—Caps (2 used)        |
| 11—Cap Screw (6 used)            |                          |                           | 42—Cap Screw (8 used)   |

/T6460FR /0210 AA4 030487

Differential on Bevel Drive

1. Remove drain plug (A) to drain oil from axle housing.

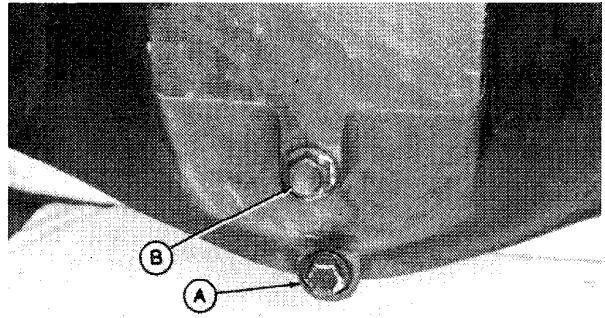

/T6460FS /0210 AA5 030487

2. Remove knuckle and axle shafts. (See procedure in Group 0240.)

**CAUTION:** The approximate weight of differential assembly is 73 kg (160 lb).

3. Remove cap screws and lock washers (A) to remove differential assembly.

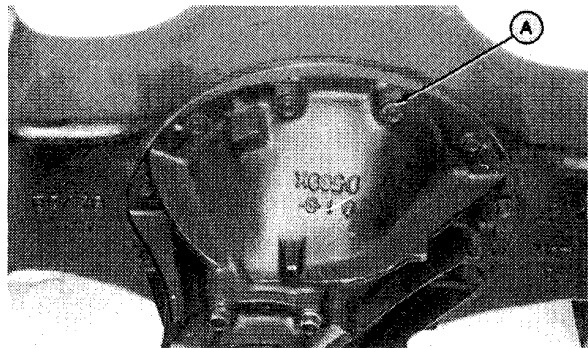

/T6460FT /0210 AA6 030487

4. Remove cap screws and lock washers (A) to remove pinion housing assembly from carrier.

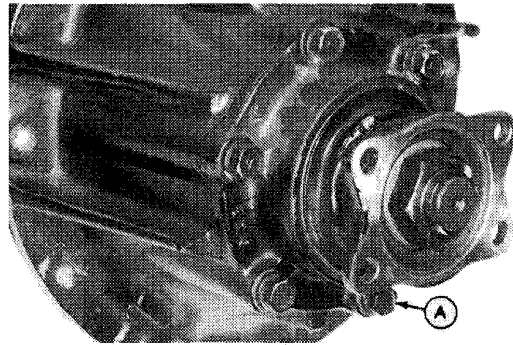

/T6460FU /0210 AA7 030487

5. Make punch marks (A) on bearing caps, carrier, and bearing nuts to aid installation in their proper position.

6. Remove cap screws (B) to remove lock plate (C).

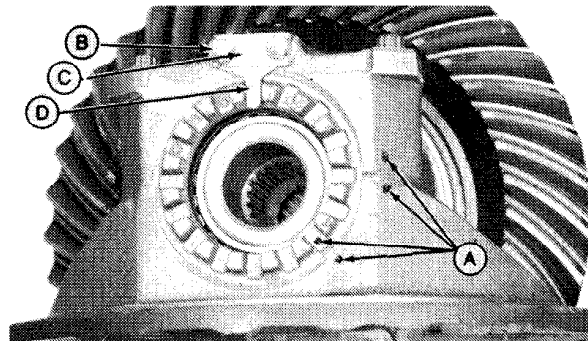

A—Punch Marks  
B—Cap Screws (4 used)

C—Lock Plate (2 used)  
D—Plate (2 used)

/T6460FV /0210 AA8 030487



**Suggest:**

**If the above button click is invalid.**

**Please download this document**

**first, and then click the above link**

**to download the complete manual.**

**Thank you so much for reading**

Differential on Bevel Drive

**CAUTION:** The approximately weight of ring gear assembly is 34 kg (75 lb).

7. Remove cap screws (A) bearing caps (B) to remove ring gear assembly from carrier.

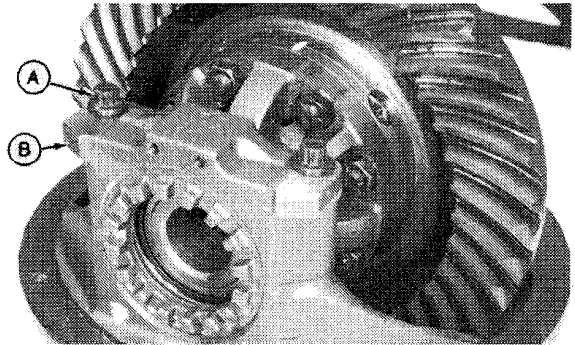

/T6460FW /0210 AA9 0304

8. Remove parts (A—D) to remove bearing (E).

A—Cotter Pin (2 used)  
B—Nut (2 used)  
C—Cap Screw (2 used)

D—Retainer (2 used)  
E—Bearing

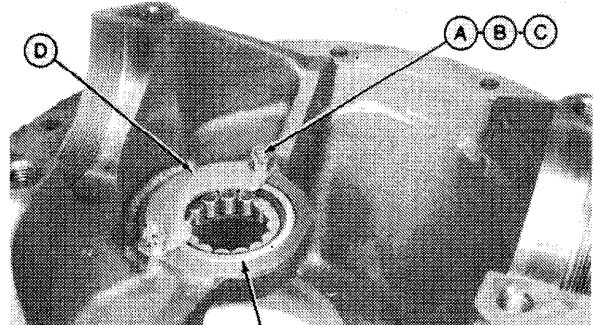

/T6460FX /0210 AA10 030487

9. Bend out tops on lock nut (A). Remove lock nut, washer (B), and flange (C).

10. Tap on pinion gear to remove from housing. Remove flange, spacer, seal, and bearings.

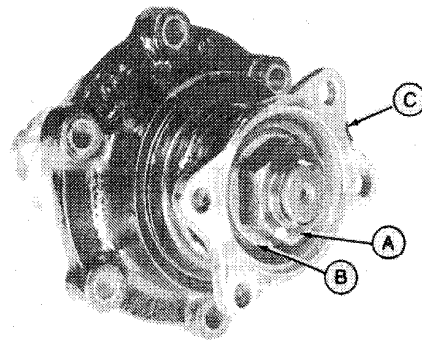

/T6460FZ /0210 AA11 030487

11. Apply index mark (A).

12. Remove nuts (B) to remove cage (C).

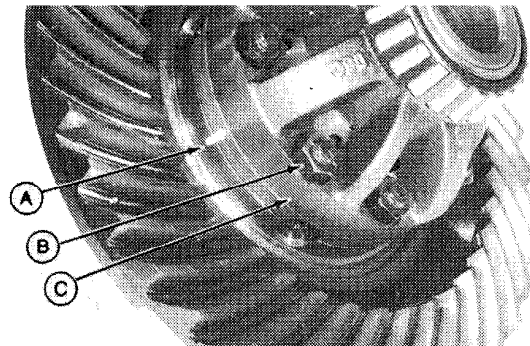

/T6460FY /0210 AA12 030487

**<https://www.ebooklibonline.com>**

Hello dear friend!

Thank you very much for reading.

Enter the link into your browser.

The full manual is available for immediate download.

**<https://www.ebooklibonline.com>**