

**John Deere  
JD570 and JD570A  
Motor Grader**

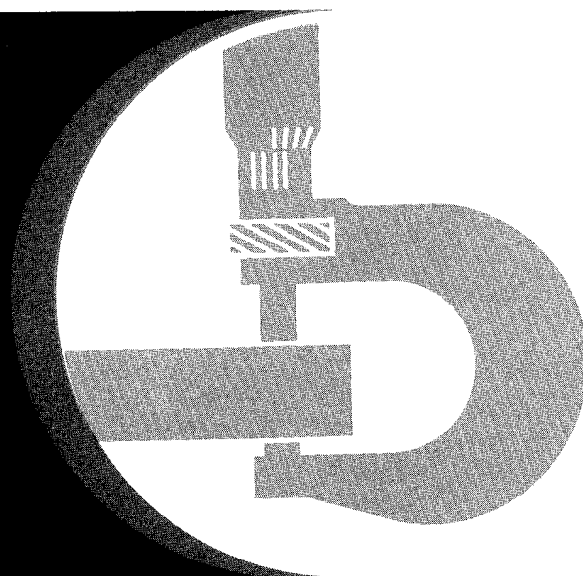

**TECHNICAL MANUAL**

**TM-1001 (Dec-87)**

# JD570 AND JD570-A MOTOR GRADERS

**Technical Manual  
TM-1001 (Dec-87)**

## CONTENTS

### Section 10 - GENERAL

- Group 5 - Specifications
- Group 10 - Predelivery, Delivery, and After-Sale Services
- Group 15 - Tune-up and Adjustment
- Group 20 - Lubrication
- Group 25 - Separation
- Group 30 - Specifications and Special Tools

### Section 20 - ENGINE

- Group 5 - Diagnosing Engine Malfunctions
- Group 10 - Basic Engine
- Group 15 - Engine Lubrication
- Group 20 - Speed Control Linkage
- Group 25 - Engine Cooling System

### Section 30 - FUEL SYSTEM

- Group 5 - Diagnosing Malfunctions
- Group 10 - Fuel Tank, Filters, and Transfer Pump
- Group 15 - Air Intake System
- Group 20 - Fuel Injection Pump  
Fuel Injection Nozzles  
(See SM-2045)
- Group 25 - Specifications and Special Tools

### Section 40 - ELECTRICAL SYSTEM

- Group 5 - Description and Wiring Diagrams
- Group 10 - Charging System - Engine  
Serial No. ( -130705)
- Group 15 - Charging System - Engine  
Serial No. (130706- )
- Group 20 - Starting Motor

### Section 50 - POWER TRAIN

- Group 5 - Engine Disconnect Clutch
- Group 10 - Transfer Drive
- Group 15 - Power Shift Transmission
- Group 20 - Differential, Differential Control and Valve
- Group 25 - Final Drive System
- Group 30 - Specifications and Special Tools

### Section 60 - POWER STEERING AND BRAKES

- Group 5 - Power Steering Valve
- Group 10 - Brake Valve
- Group 15 - Brake Cylinders and Disks
- Group 20 - Parking Brake

### Section 70 - HYDRAULIC SYSTEM

- Group 5 - Components and Tests
- Group 6 - System Testing (Analyzer) Serial No. (001700- )
- Group 10 - Filters, Valves, and Accumulator
- Group 15 - Main Hydraulic Pump
- Group 20 - Function Control Valves
- Group 25 - Hydraulic Cylinders
- Group 30 - Circle Drive Hydraulic Motor
- Group 35 - Saddle Valve and Retaining Pins
- Group 40 - Specifications and Special Tools

### Section 80 - MISCELLANEOUS

- Group 5 - Circle Drive Gearbox
- Group 10 - Drawbar, Circle and Moldboard
- Group 15 - Saddle, Main Frame, Front Axle and Scarifier
- Group 20 - Specifications and Special Tools

*The specifications and design information contained in this manual were correct at the time it was printed. It is John Deere's policy to continually improve and update our machines. Therefore, the specifications and design information are subject to change without notice.*

OOA

Litho in U.S.A.

#### Previous Editions

Copyright © 1980 Deere & Company  
Copyright © 1979 Deere & Company  
Copyright © 1978 Deere & Company  
Copyright © 1977 Deere & Company  
Copyright © 1976 Deere & Company  
Copyright © 1975 Deere & Company

Copyright © 1974 Deere & Company  
Copyright © 1973 Deere & Company  
Copyright © 1972 Deere & Company  
Copyright © 1971 Deere & Company  
Copyright © 1969 Deere & Company  
Copyright © 1967 Deere & Company

**Copyright © 1987  
DEERE & COMPANY  
Moline, Illinois  
All rights reserved**

## INTRODUCTION

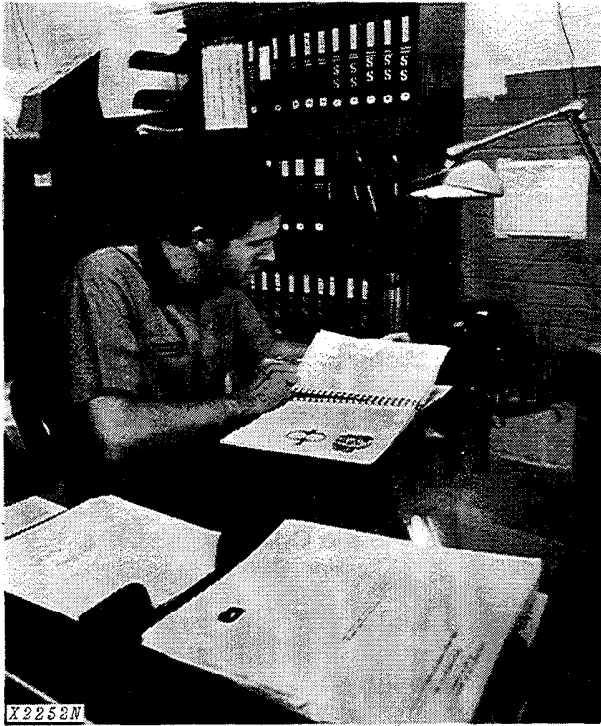

Use FOS Manuals for Reference

This technical manual is part of a twin concept of service:

The two kinds of manuals work as a team to give you both the general background and technical details of shop service.

- **FOS Manuals—For Reference**

*Fundamentals of Service (FOS) Manuals* cover basic theory of operation, *fundamentals* of trouble shooting, *general* maintenance, and *basic* types of failures and their causes. FOS Manuals are for training new personnel and for reference by experienced personnel.



When a service technician should refer to a FOS Manual for more information, a FOS symbol like the one at the left is used in the TM to identify the reference.

- **Technical Manuals—For Actual Service**

*Technical Manuals* are concise service guides for a *specific* machine. Technical Manuals are on-the-job guides containing only the vital information needed by an experienced service technician.



Use Technical Manuals for Actual Service

This technical manual was planned and written for you—an experienced service technician. Keep it in a permanent binder in the shop where it is handy. Refer to it whenever in doubt about correct service procedures or specifications.

Some features of this technical manual:

- *Table of contents at front of manual*
- *Exploded views showing parts relationship*
- *Photos showing service techniques*
- *Specifications grouped for easy reference*

Using the technical manual as a guide will reduce error and costly delay. It will also assure you the best in finished service work.



This safety alert symbol identifies important safety messages in this manual. When you see this symbol, be alert to the possibility of personal injury and carefully read the message that follows.

**<https://www.ebooklibonline.com>**

Hello dear friend!

Thank you very much for reading.

Enter the link into your browser.

The full manual is available for immediate download.

**<https://www.ebooklibonline.com>**

# Section 10 GENERAL

## CONTENTS OF THIS SECTION

	Page		Page
<b>GROUP 5 - SPECIFICATIONS</b>		<b>GROUP 25 - SEPARATION</b>	
JD570-A Machine Specifications .....	5-2,3	Separating Power Unit from Frame .....	25-1
JD570-A Dimensions .....	5-4	Separating Engine from Transmission .....	25-2
JD570 Machine Specifications .....	5-5	Separating Transfer Drive from	
JD570 Dimensions .....	5-6	Transmission .....	25-2
<b>GROUP 10 - PREDELIVERY, DELIVERY,</b>		Separating Tandems from Power Unit .....	25-3
<b>AND AFTER-SALE SERVICES</b>		Separating Clutch Housing from	
Predelivery Service .....	10-1	Transmission .....	25-3
Delivery Service .....	10-16	Assembling Clutch Housing to	
After-Sale Inspection .....	10-16	Transmission .....	25-3
<b>GROUP 15 - TUNE-UP AND ADJUSTMENT</b>		Assembling Tandems to Power Unit .....	25-3
General Information .....	15-1	Assembling Transfer Drive to	
Preliminary Engine Testing .....	15-1	Transmission .....	25-3
Engine Tune-up .....	15-1	Assembling Engine to Transmission .....	25-4
Grader Adjustment .....	15-2	Assembling Power Unit to Frame .....	25-4
Hydraulic System Average Cycle		<b>GROUP 30 - SPECIFICATIONS AND SPECIAL</b>	
Times .....	15-3	<b>TOOLS</b>	
<b>GROUP 20 - LUBRICATION</b>		Making Special Tools .....	30-1
Lubrication Chart .....	20-1	Torque Values .....	30-1
Engine Lubricating Oils .....	20-2	Special Tools .....	30-1
Greases .....	20-2		

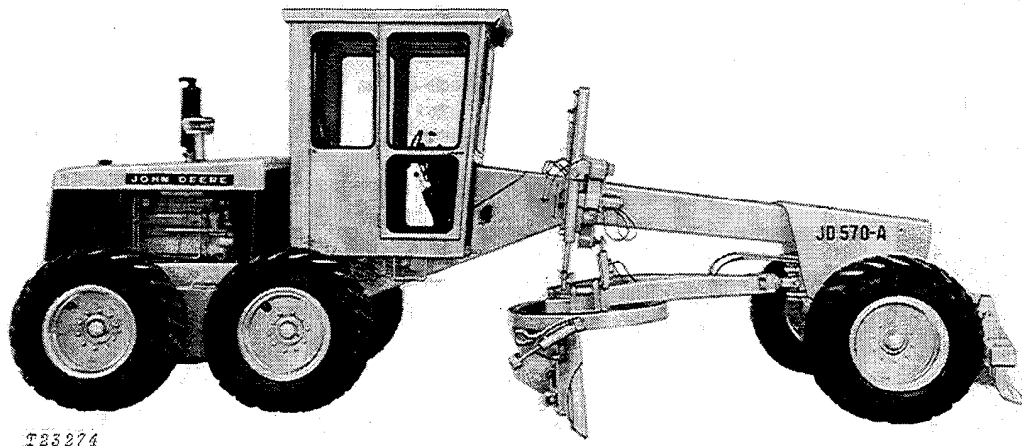

Fig. 1-JD570-A Motor Grader

# Group 5 SPECIFICATIONS

(Specifications and design subject to change without notice. Wherever applicable, specifications are in accordance with ICED and SAE Standards. Except where otherwise noted, these specifications are based on a unit equipped with 13.00-24, 8-ply-rating, tubeless tires and standard equipment.)

## JD570-A

<b>Power</b> (at 2300 engine rpm):	<b>SAE</b>	<b>DIN</b>
Gross .....	92 hp (68.6 kW*)	
Net .....	85 hp (63.4 kW)	86.2 PS

Net engine flywheel power is for an engine equipped with fan, air cleaner water pump, lubricating oil pump, fuel pump, alternator and muffler. The gross engine power is without fan. Flywheel power ratings are under SAE standard conditions of 500-ft. altitude and 85°F. temperature, and DIN 70 020 conditions (non-corrected). No derating is required up to 10,000 feet (3000 m) altitude.

\*In the international system of units (SI), power is expressed in kilowatts (kW).

**Engine:** John Deere turbocharged diesel, vertical 6-cylinder, valve-in-head, 4-stroke cycle

Bore and stroke .....	4.02x4.33 in. (102x110 mm)
Piston displacement .....	329 cu. in. (5392 cm <sup>3</sup> )
Compression ratio .....	16.2 to 1
Maximum torque @ 1300 rpm ...	238 lb-ft (323 Nm) (32.8 kg-m)
NACC or AMA (U.S. Tax) horsepower .....	38.6
Main bearings .....	7
Lubrication .....	Pressure system w/full-flow filter
Cooling .....	Pressurized w/thermostat and fixed bypass
Fan .....	Suction
Air cleaner w/restriction indicator .....	Dry
Electrical system .....	12-volt w/alternator
Batteries (2) .....	Reserve capacity: 360 minutes

**Transmission:** Power Shift, 8 forward and 4 reverse selections

**Differential Lock:** Foot-operated, hydraulically actuated

**Travel Speeds** (2300 engine rpm, no tire slip):

Shift Lever Position	mph	km/h
Forward 1	2.0	3.3
2	2.9	4.6
3	4.5	7.2
4	5.8	9.4
5	7.6	12.2
6	9.8	15.8
7	12.8	20.6
8	21.6	34.8
Reverse 1	2.5	4.0
2	3.5	5.6
3	5.5	8.8
4	7.1	11.4

**Final Drives:** Inboard planetary

### Brakes:

**Service:** Foot-operated, hydraulically actuated, wet-disk, effective on 4 tandem wheels  
**Parking:** Hand-operated, mechanical, expanding dry shoe, effective on 4 tandem wheels

### Steering:

**Front:** Full hydraulic power system  
**Rear:** Hydraulically articulated frame steering (22 deg. left or right)  
**Turning radius:** 18 ft. (5.49 m)  
**Range:** 51 deg. left or right

### Hydraulic System: Closed-center

**Pressure:** 2000 psi (137.9 bar) (140.6 kg/cm<sup>2</sup>)  
**Pump:** Variable displacement, 27 gpm (102 L/min) @ 2300 engine rpm

**Circle:** 5.50x1x4.62x1 in. (140x25x117x25 mm) welded angle, 4 ft. 6 in. (1.37 m) dia.

**Rotation:** 360 deg.  
**Drive:** Hydraulic motor and worm gear

**Drawbar:** Tapered box, max. 3x7x0.375 in. (76x178x9.5 mm) wall, w/universal swivel

### Blade:

	Standard	Optional
Length .....	12 ft. (3.66 m)	12 ft. (3.66 m)
Height .....	22 in. (559 mm)	22 in. (559 mm)
Thickness .....	0.62 in. (15.8 mm)	0.75 in. (19.1 mm)

### Blade Lifting Mechanism:

**Control:** Dual-lever, hydraulic  
**Cylinders (2):** 3 in. (76 mm) dia. bore; 42 in. (1.07 m) stroke

### Blade Range:

**Lift above ground:** 1 ft. 1 in. (330 mm)  
**Blade side-shift:**  
Right .....

Right .....	2 ft. 2.75 in. (679 mm)
Left .....	2 ft. 7.25 in. (794 mm)

**Shoulder reach outside wheels:**  
Right .....

Right .....	5 ft. 11.5 in. (1.82 m)
Left .....	6 ft. 5.25 in. (1.96 m)

**Pitch:** 32 deg. total

**JD570-A**

**Saddle:**

Rotation ..... 45 deg. right or left, 5 positions  
 Control ..... Single foot-operated release hydraulically controls tapered locking pins

**Frame: Tapered box**

Section size, max..... 16.5x8 in. (419x203 mm)  
 min..... 12.5x8 in. (318x203 mm)  
 Weight per ft. max..... 99 lb. (147.3 kg/m)  
 av. .... 91 lb. (135.4 kg/m)

**Tandems:** Welded steel box section 1 ft. 9.75 in. (552 mm)x6.5 in. (165 mm)

Drive ..... 1.75 in. (44 mm) pitch roller chain  
 Axle dia. at bearings ..... 3.25 in. (83 mm)  
 2.62 in. (67 mm)

**Front Axle:** Fabricated steel A-frame with cast alloy-steel spindles, tapered roller bearings

Diameter at bearing seats ..... 2.62 in. (67 mm)  
 2.06 in. (52 mm)  
 Total oscillation..... 30 deg.  
 Wheel lean (either direction) ..... 20 deg.

**Rear Drive Axle:** Full floating with tapered roller bearings

Diameter at bearings..... 3.28 in. (83 mm)

**Scarifier (Special Equipment):** V-type for 46 in. (1.17 m) cut with 3 manual pitch positions

Number of teeth ..... 5 standard, 9 optional  
 Lift above ground ..... 1 ft. 10.5 in. (572 mm)  
 Penetration ..... 8.75 in. (222 mm)  
 Maximum pressure—down..... 7000 lb. (31.37 kN) (3175 kg)  
 up ..... 20,000 lb. (89.64 kN) (9072 kg)  
 Shank size..... 1x3 in. (25x76 mm)

**Bulldozer** ..... (Special Equipment): Mounts on scarifier linkage. Angles 22 deg. left or right by articulating machine.

Length ..... 93 in. (2.36 m)  
 Height ..... 23.5 in. (597 mm)  
 Lift above ground ..... 27 in. (686 mm)  
 Penetration ..... 4 in. (102 mm)

**Capacities:**

	U.S.	Imp	Liters
Fuel tank	50 gal.	41.7 gal.	189.3
Cooling system	5.6 gal.	4.7 gal.	21.2
Engine lubrication, including filter	3 gal.	2.5 gal.	11.4
Engine lubrication, without filter	10 qt.	2.1 gal.	9.5
Transmission and hydraulic system	21 gal.	17.5 gal.	79.5
Tandem housings (each)	5 gal.	4.2 gal.	18.9
Worm gearbox	1.5 qt.	1.3 qt.	1.4

**Additional Standard Equipment:**

Transistorized voltage regulator  
 Lights  
 Turn signals  
 Electric hour meter  
 Cigar lighter  
 Horn  
 Deluxe seat  
 Transmission bottom guard

**Gauges:**

Coolant temperature  
 Transmission temperature  
 Engine oil pressure  
 Fuel  
 Cold weather starting aid  
 Precleaner  
 ROPS cab and seat belt  
 Work lights  
 Cab heater  
 Front windshield wiper  
 Rear windshield wiper

**Special Equipment:**

Scarifier  
 Cab defroster fan  
 Floor mat  
 ROPS canopy and seat belt  
 2 ft. (610 mm) moldboard extensions, right or left  
 Disconnect clutch

12 ft. (3.66 m) heavy-duty blade  
 Engine side shields  
 Overlay end bits  
 Bulldozer  
 Wheel weights for 24 in. (610 mm) tires  
 Heavy-duty cutting edges  
 Automatic blade control



(Unit Equipped w/13.00 - 24, 8-ply Rating Tubeless Tires)

**JD570**

**HORSEPOWER** (at 2300 rpm)  
 Net engine flywheel at 500 ft.  
 altitude and 85 deg. F. temperature .....83

**ENGINE**  
 NACC or AMA taxable horsepower ..... 35.9  
 Cycle ..... 4  
 No. of Cylinders ..... 6  
 Rated RPM ..... 2300  
 Bore and Stroke ..... 3.86 in. x 4.33 in.  
 Piston Displacement ..... 303 Cu. in.  
 Electric System ..... 12 volts  
 Starting ..... Electric

**TRANSMISSION**  
 Description ..... Power Shift Transmission  
 Lock-Unlock Differential

**GROUND SPEEDS**  
 1st ..... 2.04 mph  
 2nd ..... 2.88 mph  
 3rd ..... 4.49 mph  
 4th ..... 5.81 mph  
 5th ..... 7.42 mph  
 6th ..... 9.67 mph  
 7th ..... 12.80 mph  
 8th ..... 21.40 mph  
 1st Rev. .... 2.36 mph  
 2nd Rev. .... 3.36 mph  
 3rd Rev. .... 5.24 mph  
 4th Rev. .... 6.77 mph

**STEERING**  
 Type  
 Front ..... Full Hydraulic Power Steering  
 Rear ..... Hydraulic-Articulated  
 Frame Steering  
 Turning Radius ..... 18 ft.

**BRAKES**  
 Service ..... Foot-operated, hydraulic-ac-  
 tuated, wet-disk type, effec-  
 tive on 4 tandem wheels

Parking ..... Hand-operated mechanical ex-  
 panding dry-shoe type, effective  
 on 4 tandem wheels

**CIRCLE**  
 Diameter ..... 54 in.  
 Type of Drive ..... Hydraulic Motor and  
 Worm Gear  
 Rotation ..... 360 deg.

**BLADE RANGE**  
 Lift above Ground ..... 13 in.  
 Blade Side Shift  
 Right ..... 26.75 in.  
 Left ..... 31.25 in.  
 Shoulder Reach, Outside Wheels  
 Right ..... 71.50 in.  
 Left ..... 77.25 in.  
 Bank Cutting Angle (Right and Left) .. 90 deg.  
 Pitch ..... 32 deg.

**BLADE LIFTING MECHANISM**  
 Saddle (Hydraulically  
 Actuated) ..... 5 position - 22.5 deg.  
 Increment Rotations  
 Total Rotation Right  
 or Left 45 deg.  
 Cylinders ..... 3 in. bore x 42 in. stroke

**BLADE ASSEMBLY**  
 Length ..... 10 ft. or 12 ft.  
 Height ..... 22 in.  
 Thickness ..... standard 0.62 in.  
 heavy-duty 0.75 in.

**AXLE FRONT**  
 Front Wheel Lean ..... 20 deg. left and right  
 Steering Range ..... 51 deg. left and right  
 Ground Clearance  
 with 10.00-24 Tires  
 (Early Units) ..... 21.75 in.  
 with 13.00-24 Tires ..... 23.5 in.  
 with 15.50-25 Tires ..... 23.0 in.  
 Oscillation ..... 30 deg.

**HYDRAULIC SYSTEM**  
 Type ..... Closed center  
 Pump ..... Variable displacement piston type

**JD570**

**CAPACITIES**

Fuel Tank .....	50 gal.
Cooling System .....	22.4 quarts
Crankcase (with Filter) .....	10 quarts
Transmission (with Filters) (Includes Hydraulic System) .....	21 gal.
Tandem Housings (Each) .....	5 gal.
Worm Gear Box .....	1.5 quarts

**SCARIFIER**

Weight (without Teeth) .....	652 lbs.
(with Teeth) .....	878 lbs.
No. of Teeth .....	11
Lift Above Ground .....	22-1/2 in.
Penetration .....	8-3/4 in.
Pitch Positions .....	3
Controls .....	Hydraulic
Max. Force. 7,000 lbs. Down—20,000 lbs. Up	
Width of Cut .....	50 in.
Shank Size .....	1 in. x 3 in.
Type .....	"V"

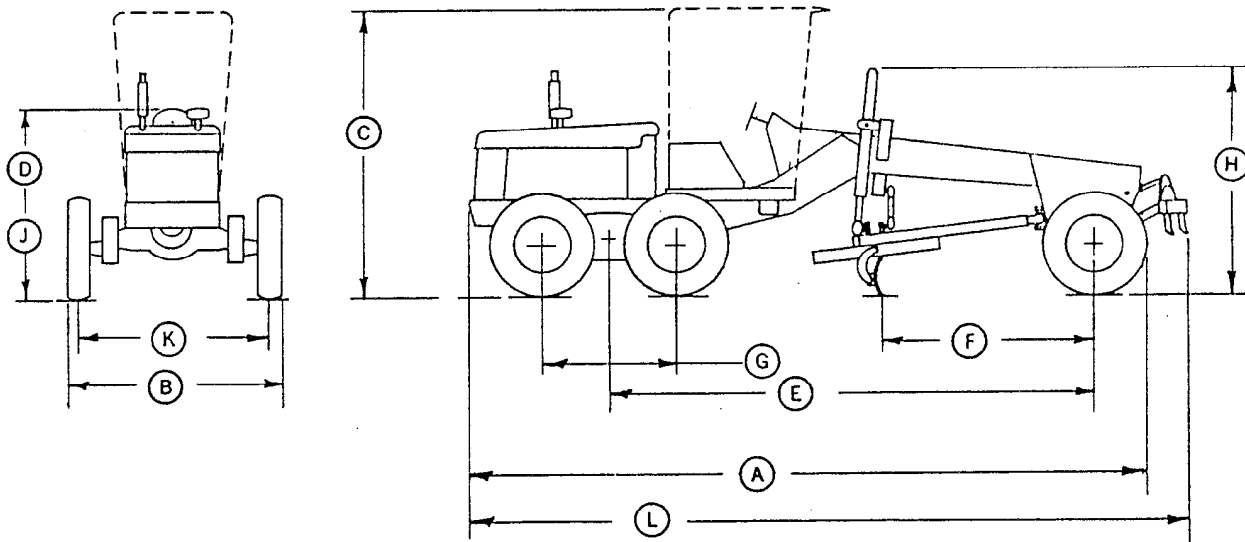

Fig. 2- JD570 Dimensions Specifications

Over-All Dimensions	Inches	Over-All Dimensions	Inches
A. Length .....	24 ft. 4.5 in.	G. Tandems (Center Line) .....	4 ft. 8.75 in.
B. Width (13.00-24 tires) .....	7 ft. 10.75 in.	H. Height (Top Lift Cylinders) .....	8 ft. 3.5 in.
(15.50-25 tires) .....	8 ft. 3.75 in.	J. Height (Top Air Cleaner) .....	7 ft. 5.5 in.
C. Height (with Cab) .....	10 ft. 6 in.	K. Tread (Front) 13.00-24 tires) ....	6 ft. 6.75 in.
D. Height (without Cab - To Top of Steering Wheel) .....	7 ft. 5 in.	(Front) (15.50-25 tires) .....	6 ft. 9.12 in.
E. Wheelbase .....	17 ft. 4 in.	(Rear) (13.00-24 tires) .....	6 ft. 9.12 in.
F. Bladebase .....	7 ft. 8 in.	(Rear) (15.50-25 tires) ....	6 ft. 11.75 in.
		L. Length with Scarifier (In Up Position) .....	26 ft. 8.5 in.

**JD570**

**WEIGHT**

Operating - Total  
(standard equipment  
without cab) ..... 18625 lbs.  
(standard equipment  
with cab) ..... 19925 lbs.  
(standard equipment  
and scarifier) ..... 20803 lbs.

On Front Wheels  
(standard equipment  
without cab) ..... 5505 lbs.  
(with cab) ..... 5705 lbs.  
(standard equipment  
and scarifier) ..... 6755 lbs.

On Rear Wheels  
(standard equipment  
without cab) ..... 13120 lbs.  
(with cab) ..... 14220 lbs.  
(standard equipment  
and scarifier) ..... 14048 lbs.

*(Specifications and design are subject to change without notice. Wherever applicable, specifications are in accordance with ICED and SAE Standards.)*

# Group 10 PREDELIVERY, DELIVERY, AND AFTER-SALE SERVICES

## TEMPORARY UNIT STORAGE

After receiving your unit from the factory and before putting the machine into temporary storage, perform the following checks and services.

For long term storage (over 30 days) information, consult your JD570-A operator's manual.

1. Check battery electrolyte level and charge the battery, if necessary.
2. Check coolant level: Maintain 4 inches below the top of the filler neck.
3. Fill the fuel tank.
4. Check crankcase oil level. Oil should be between marks on dipstick after machine has been shut down for 10 minutes.
5. Relieve hydraulic pressure by stopping engine, lowering blade and operating control levers until system fails to respond.
6. Reduce shipping pressure of all tires to inflation pressure shown on page 10-10-9.
7. Cover unit for protection and cleanliness.

## PREDELIVERY SERVICE

Because of the shipping factors involved, plus extra finishing touches that are necessary to promote customer satisfaction, proper predelivery service is of prime importance to the dealer and the customer.

If adjustments are required, procedures are found in the after-sale section.

Use the following list when preparing a motor grader for delivery to the customer.

### 1. Pre-Cleaner



Fig. 1-Pre-Cleaner

Check pre-cleaner bowl. Clean if necessary.

Pre-cleaner checked

Yes No

## 2. Air Cleaner

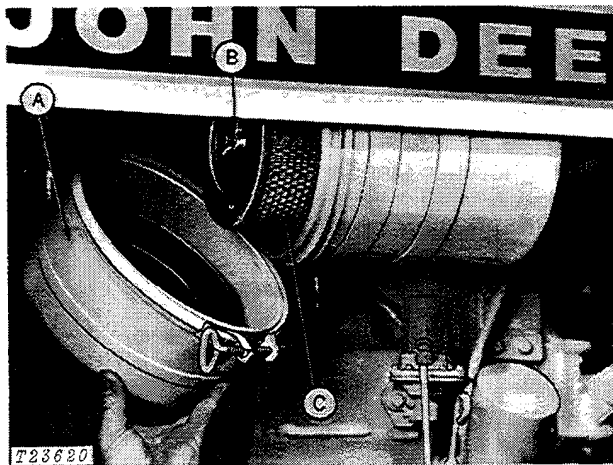

A—Dust Cap  
 B—Wing Nut  
 C—Primary Element

Fig. 2-Air Cleaner

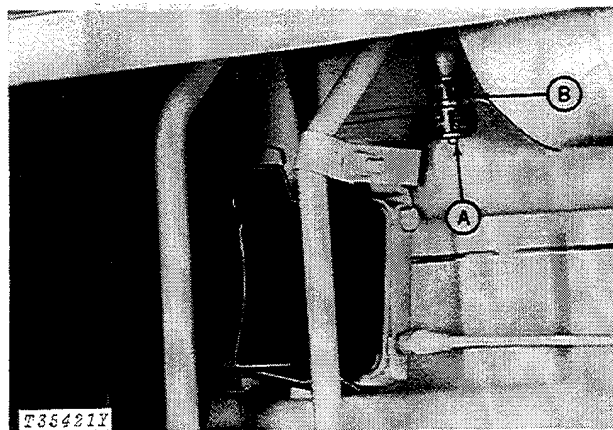

A—Reset Button  
 B—Red Signal

Fig. 3-Restriction Indicator

Check air cleaner restriction indicator. If indicator shows red, check elements. If only primary element is dirty, clean the element. If safety element is dirty, replace both elements.

Air cleaner checked	Yes	No
Elements replaced	Yes	No

## 3. Fuel Filter

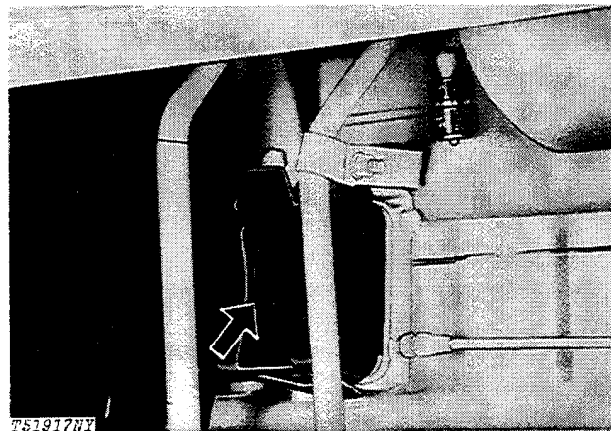

Fig. 4-Fuel Filter

Check fuel filter for sediment. Drain if necessary.

To bleed fuel system, see page 10-10-21.

Sediment present in filter	Yes	No
----------------------------	-----	----

## 4. Batteries

Check battery electrolyte level. If distilled water is not available, use clean soft water. Avoid use of hard water. Remove foreign material from top of battery and coat terminals with petroleum jelly.

**IMPORTANT:** Never add water to battery in freezing weather unless engine will be run 2 to 3 hours.

Check battery connections.

Punch date code on battery.

Battery connections checked	Yes	No
Water added	Yes	No

### 5. Fuel Tank

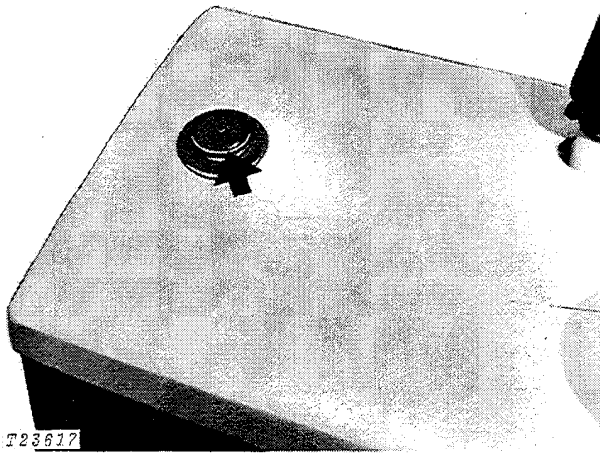

Fig. 5-Fuel Tank Filler Cap

Fill fuel tank with proper fuel. Check action of fuel gauge.

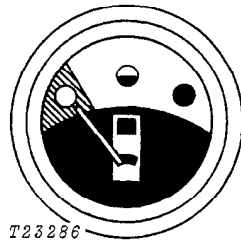

Fig. 6-Fuel Gauge

Fuel tank filled	Yes	No
Fuel gauge checked	Yes	No

### 6. Fuel Tank Sump

**IMPORTANT:** Sediment will settle over extended periods of transport or storage.

Open fuel tank drain cock. Drain liquid for several seconds. Close drain cock.

**NOTE:** Fuel tank sump drain is located on the bottom of the fuel tank.

Fuel sump drained	Yes	No
-------------------	-----	----

### 7. Radiator

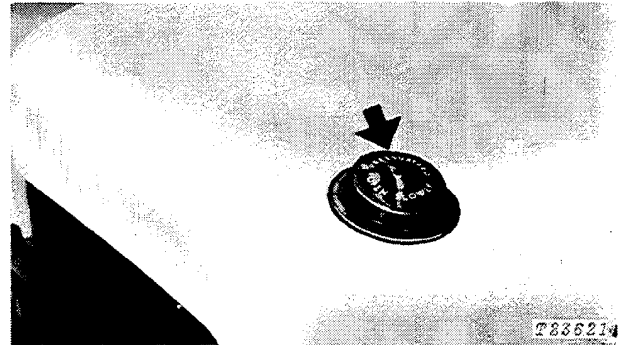

Fig. 7-Radiator Filler Cap

**CAUTION:** Remove radiator filler cap only when coolant temperature is below boiling point. Then loosen cap slightly to the stop to relieve pressure before removing the cap completely.

Check coolant level. Maintain 4 inches below the top of the filler neck. Add permanent-type antifreeze if cold weather is expected.

Radiator coolant level checked	Yes	No
Coolant or antifreeze added	Yes	No

**8. Tandem Drives**

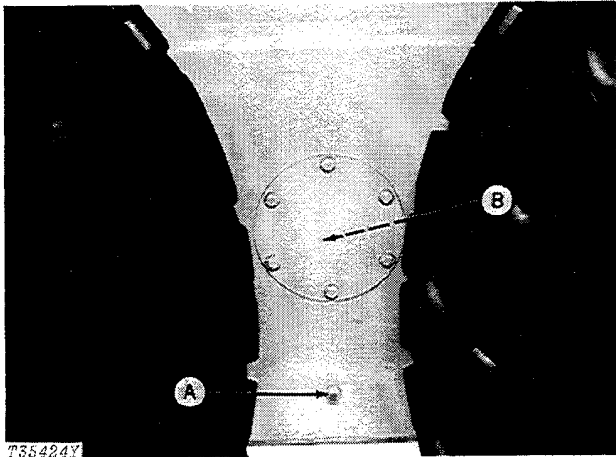

**A—Oil Level Plug**                      **B—Main Drive Sprocket Retainer**

Fig. 8-Tandem Drives

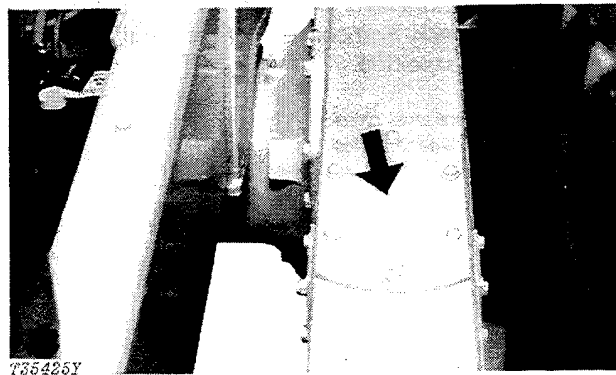

Fig. 9-Tandem Drive Inspection Plate

Park grader on level surface. Remove inspection plate from each tandem. Make sure oil reservoirs in front and rear outboard hubs are full.

Remove oil level plug from each tandem. Oil should be level with plug hole.

If oil is needed, use John Deere HY-GARD® Oil or equivalent.

Install inspection plate and plug.

Tandem oil level checked                      Yes    No

**9. Crankcase Oil Level**

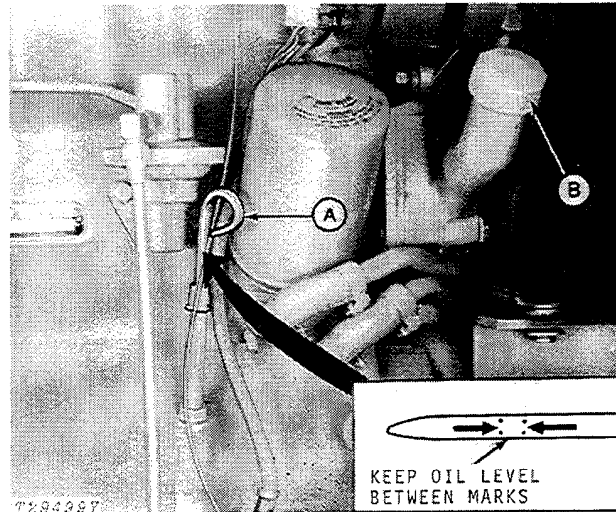

**A—Crankcase Dipstick**                      **B—Crankcase Filler Cap**

Fig. 10-Crankcase Oil Level

Check crankcase oil level with machine on level ground and engine off. If oil level is at or below bottom mark on dipstick, add oil specified on page 10-20-2 to bring oil level to between marks on dipstick. Do not operate engine with oil level below the bottom mark.

*NOTE: There is a 3-1/2 quart difference between the bottom mark and the top mark on the dipstick.*

Crankcase oil level checked                      Yes    No  
 Oil added, if any    \_\_\_\_\_ qts.

### 10. Circle Drive Gear Box

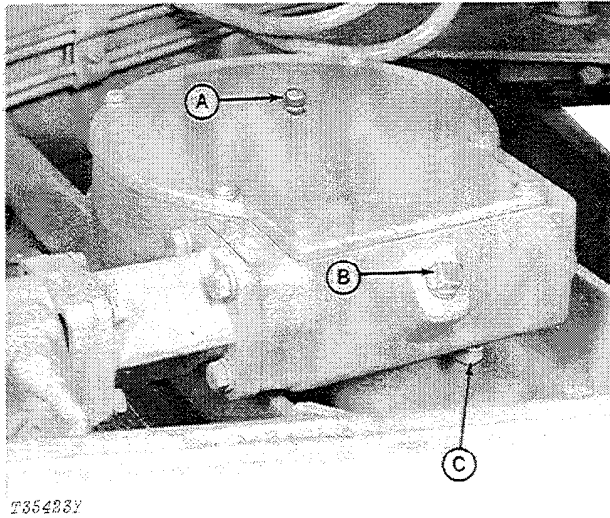

A—Vent  
 B—Oil Level and Filler Plug  
 C—Drain Plug

Fig. 11—Circle Drive Gear Box

With the blade resting on level ground, check the circle drive gear box oil level by removing the oil level plug. Oil should be level with the plug hole. If necessary, add John Deere SCL oil or equivalent. (See page 10-20-2.) Replace filler plug.

Circle drive gear box oil level checked Yes No  
 Oil added \_\_\_\_\_ qts.

### 11. Alternator - Fan Belts

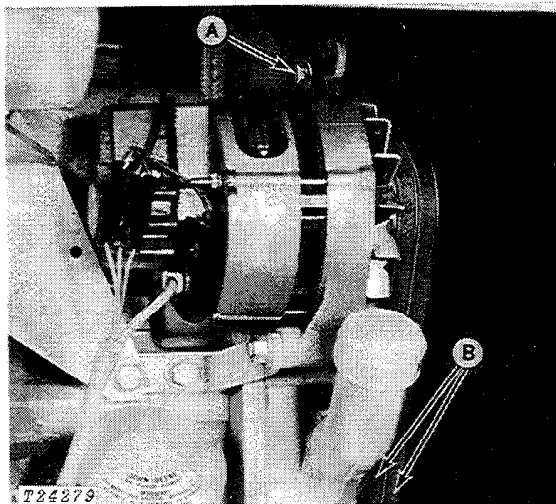

A—Adjusting Cap Screw  
 B—Alternator-Fan Belts

Fig. 12—Alternator - Fan Belts

Alternator-fan belt should deflect 3/4-inch when 20 pounds of force is applied to the belt midway between the two pulleys. Check front belt only. If a belt gauge is used, tighten new alternator belt to 100 pounds strand tension. After 3 minutes of operation, tension should be 90 pounds minimum.

**IMPORTANT:** Do not pry on the rear alternator housing as this may damage the alternator.

Alternator-fan belt tension \_\_\_\_\_ lbs. strand tension  
 \_\_\_\_\_ inch deflection

### 12. Air Intake Hoses

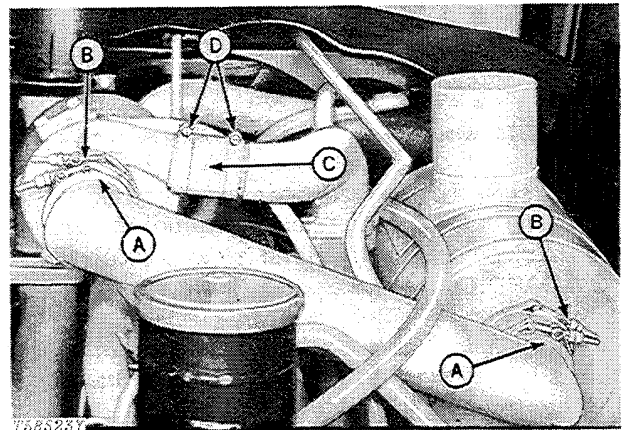

A—Air Intake Hose  
 B—Air Intake Hose Clamps  
 C—Turbocharger Inlet Hose  
 D—Turbocharger Inlet Hose Clamps

Fig. 13—Air Intake Hoses and Clamps

Check hoses (A) for cracks. Tighten clamps (B). Also check turbocharger inlet hose (C) and clamps (D).

Air intake hoses checked Yes No

### 13. Transmission-Hydraulic System Oil Level

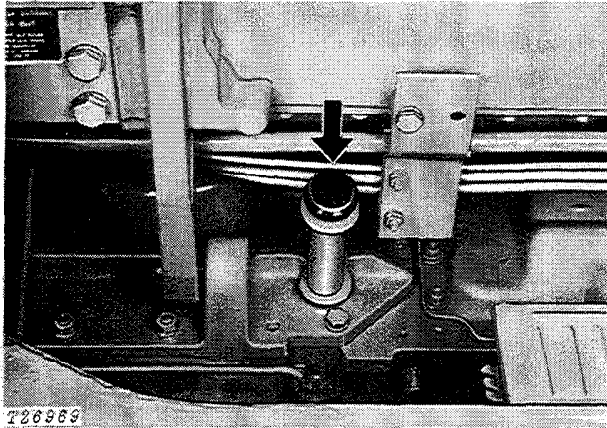

Fig. 14-Transmission-Hydraulic System Filler Cap and Dipstick

Be sure dipstick has been fully inserted before checking oil level. Do not start engine, unless oil is near top mark on dipstick. If oil level is low, add John Deere HY-GARD Oil or equivalent. Replace dipstick.

If the engine has been running and the transmission oil is warm, allow 10 minutes for oil to drain down before checking.

**NOTE:** Overfilling of the transmission-hydraulic system may cause overheating during extended 8th gear transport.

Transmission-hydraulic oil level checked Yes No  
 Transmission-hydraulic oil added \_\_\_\_\_ qts.

### 14. Engine Speeds

Warm up engine and attach a tachometer in the hour meter drive plug hole to check engine speeds.

No-load, fast idle speed should be  $2450 \pm 50$  rpm. Slow idle should be  $900 \pm 25$  rpm.

If engine speeds need adjustment, see page 10-10-25.

Engine speeds checked Yes No

### 15. Parking Brake

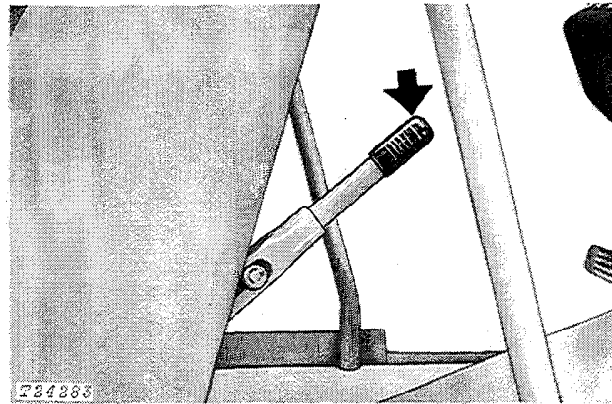

Fig. 15-Parking Brake Lever

Check parking brake adjustment.

A lifting force of 75 lbs (minimum) is required to set the parking brake lever. Check with spring scale attached to adjustment knob on end of parking brake lever.

If adjustment is required, see page 10-10-26.

Parking brake operational Yes No

### 16. Seat Operation

Check operation of seat.

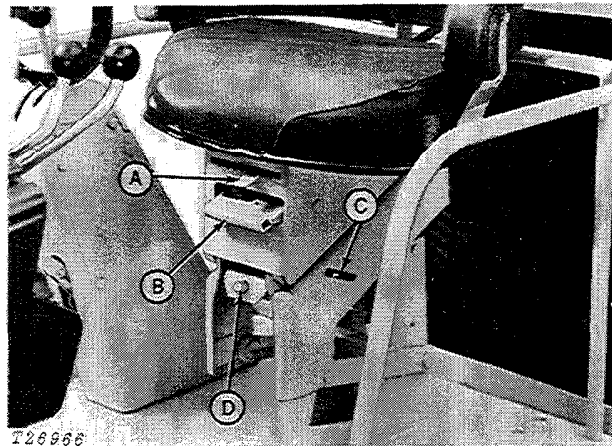

A—Seat Position Selector Lever  
 B—Seat Release Latch  
 C—Indicator  
 D—Weight Adjusting Screw

Fig. 16-Seat Operation

Move seat to upper rear position. Then sit down and move seat position selector lever (A) left or right until you reach desired position. Seat will always return to this position when you sit down after you have moved seat up and to rear for standing.

Turn weight adjusting screw (D) clockwise or counterclockwise until indicator (C) conforms to your weight.

To move seat up and back, stand up and lift seat-release latch (B). Seat will move automatically to upper rear position. Sit down to return seat to normal preset operating position.

If seat does not move fully to the rear when unlatched, adjust counterbalance spring as follows:

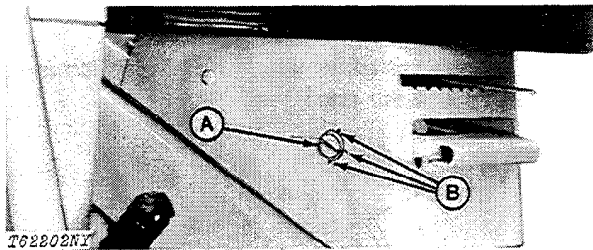

A—Seat Counterbalance Shaft      B—Notches

Fig. 17—Seat Counterbalance Shaft

Move the seat to the upper rear position. Insert a screwdriver in the slot in the counterbalance shaft, push in to unlatch the shaft, and turn the shaft counterclockwise. Align the latch in the end of the shaft with the notches in the side of the seat support and pull the screwdriver outward to latch the shaft.

Seat operation checked Yes    No

### 17. Light Operation

Check operation of lights and switches.

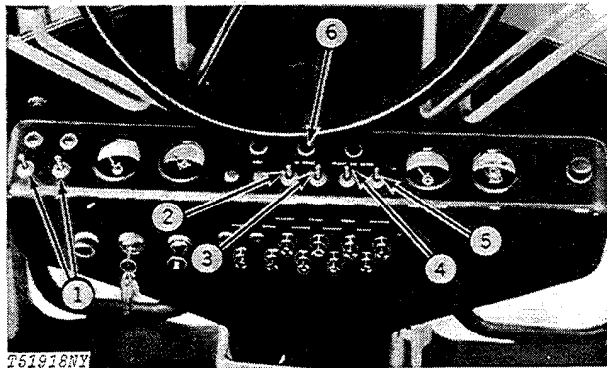

1—Direction Signal Switches      4—Work Light Switch  
2—Beacon Light Switch          5—Drive Light Switch  
3—Panel Light Switch            6—Hi-Beam Indicator Light

Fig. 18—Light Switches

Push all switches forward to turn lights on. Pull switches rearward to turn lights off.

Litho in U.S.A.

Turn signal switches (1) must be turned off after a turn. Turn both switches on for emergency flashers.

Dimmer switch on left floor panel controls high beam indicator light.

Lights and switches checked Yes    No

### 18. Transmission Shifting

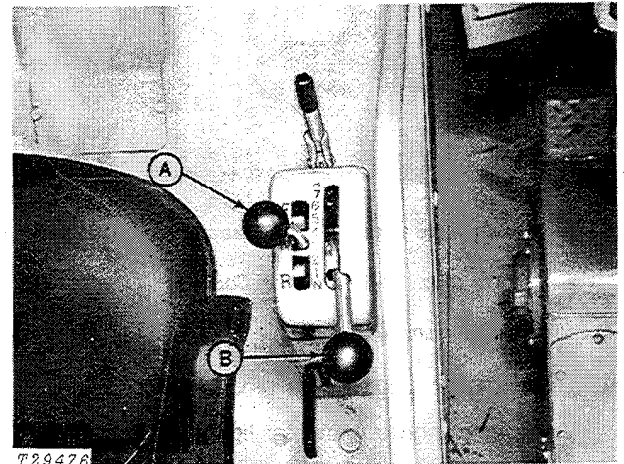

A—Forward-Reverse Lever      B—Transmission Shift Lever

Fig. 19—Transmission Controls

Check operation of motor grader in all gears.

To move grader forward, release parking brake, push forward-reverse lever into forward position, and move transmission shift lever to desired gear. Shift one gear at a time.

Use the forward-reverse lever to change the direction of travel "on the go" without declutching or shifting gears.

Transmission checked Yes    No

### 19. Reverser Operation

Check operation of forward-reverse lever.

*NOTE: Parking brake must be released before forward-reverse lever can be shifted out of neutral.*

To reverse grader, pull forward-reverse lever rearward to reverse position. With transmission shift lever in 5th gear or higher, forward-reverse lever cannot be put in reverse position.



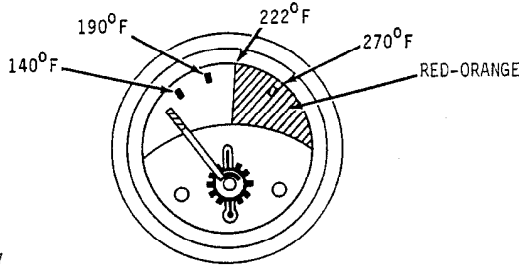

T62205N

Fig. 25-Transmission Oil Temperature Gauge

If indicator hand enters the red-orange zone, operate in a lower gear or speed. If hand remains in the red-orange zone, check transmission oil level or inspect for plugged oil cooler.

Indicator lights and gauges checked Yes No

## 21. Tire Pressure

Check the air pressure in all the tires with an accurate gauge having 1 psi graduations.

**IMPORTANT: All tires must be inflated to the same pressure.**

Adjust pressure in tires to the following specifications:

Tire size	Ply Rating	Inflation Pressures psi
13.00-24	8	25
13.00-24	10	30
15.5-25	8	25

Tire pressure checked Yes No

## 22. Differential Lock Operation

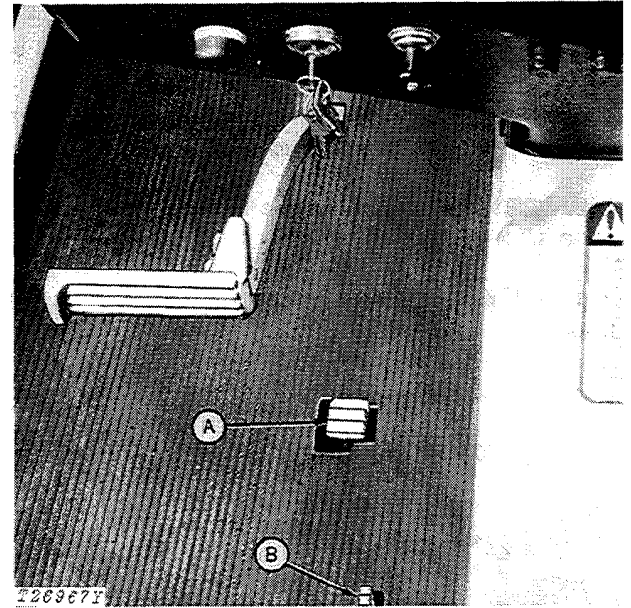

A—Front Pedal (Locked) B—Rear Pedal (Unlocked)

Fig. 26-Differential Lock Pedal

Check differential lock operation.

- 1 - Lift all four rear wheels off the ground.
- 2 - Move the transmission shift lever into first gear.
- 3 - Move the hand throttle to half-throttle position.
- 4 - Push down the front pedal (A, Fig. 26) to engage the differential lock.
- 5 - Push down the right (R.H.) brake pedal. If the differential lock is working correctly, the engine will slow down immediately.
- 6 - Release the brake pedal.
- 7 - Follow the same procedure with the left (L.H.) brake pedal.
- 8 - Push down the rear pedal (B; Fig. 26) to disengage the differential lock.

**IMPORTANT: Use first gear and half-throttle ONLY.**

9 - Push down the right (R.H.) brake pedal. If brakes engage correctly and the differential lock disengages correctly, the right (R.H.) wheels will stop and the left (L.H.) wheels will keep turning (speed-up).

**IMPORTANT: Hold the brake pedal down only for a short time.**

10 - Follow the same procedure with the left (L.H.) brake.

Differential lock checked Yes No

### 23. Hydraulic Brakes

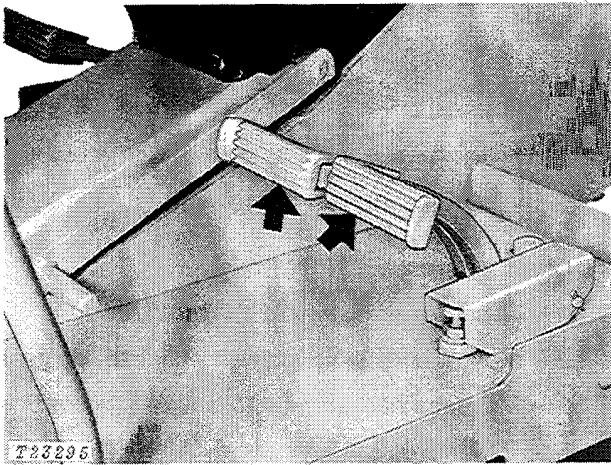

Fig. 27-Brake Pedals

Check brake system for leaks or improper operation.

Put grader in gear and depress brake pedal. Moderate pedal force should hold grader in place.

If pedal force does not hold grader in place, pedal feels spongy or bottoms out, repair is required, or system may require bleeding (page 10-10-30).

Brakes operational Yes No

### 24. Blade Lever Operation

Check operation of blade levers.

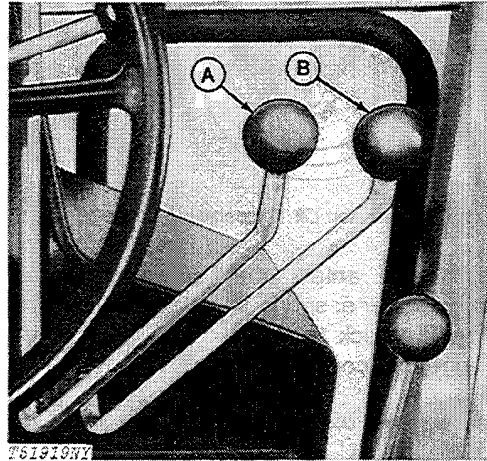

A—Left Blade Lift Lever

B—Right Blade Lift Lever

Fig. 28-Blade Lift Levers

Move levers A and B forward to lower the blade and rearward to raise the blade. Levers can be operated individually to position the blade at the desired working angle, or operated at the same time to lower the blade to working depth.

Blade lever action checked Yes No

### 25. Inching Pedal Operation

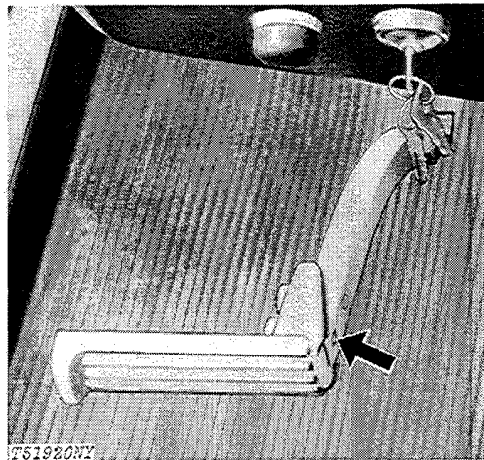

Fig. 29-Inching Pedal

Check inching pedal operation.

While driving the motor grader, depress the inching pedal completely. The transmission should disengage the drive wheels.

Inching pedal checked Yes No

### 26. Steering

Start engine and turn steering wheel. Steering should be free with engine running.

Steering operational Yes No

### 27. Lubrication

The motor grader was checked and lubricated before it left the factory. However, to insure customer satisfaction, check each lubrication point shown on the following pages. Lubricate with several strokes of John Deere Multi-Purpose Grease or equivalent, if necessary.

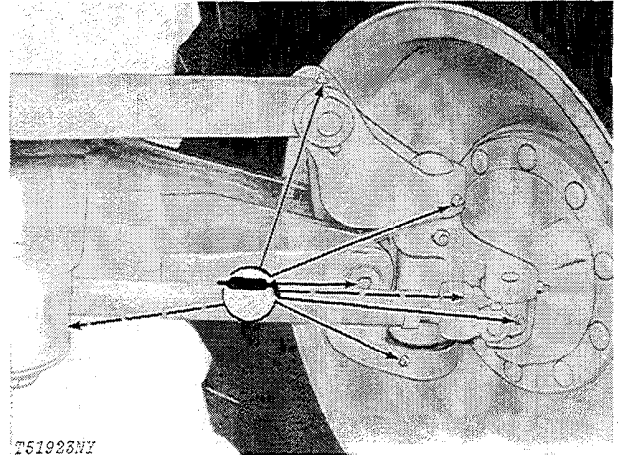

T61923NY

Fig. 32-Right Front Axle (7 points)

Lubricant required

Yes No

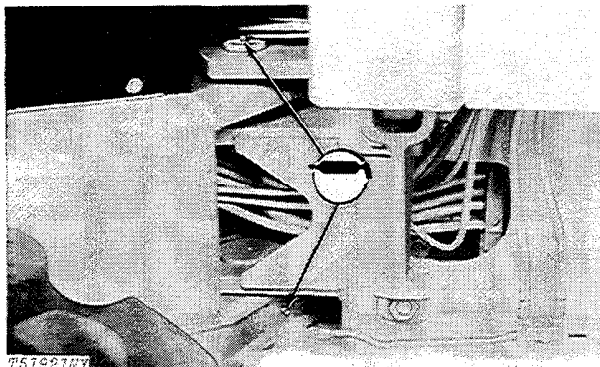

T61921NY

Fig. 30-Frame Pivot (2 points)

Lubricant required

Yes No

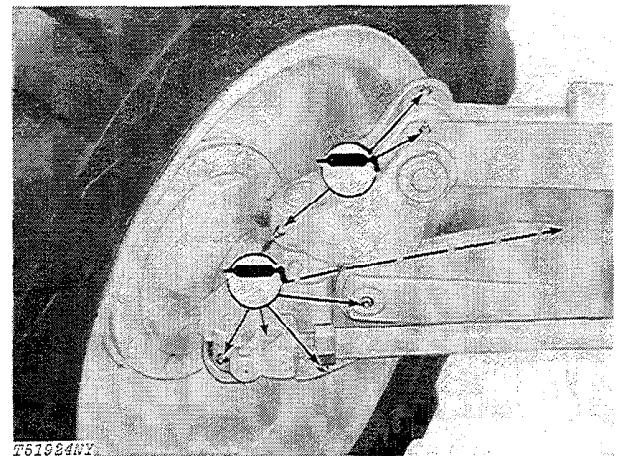

T61924NY

Fig. 33-Left Front Axle (8 points)

Lubricant required

Yes No

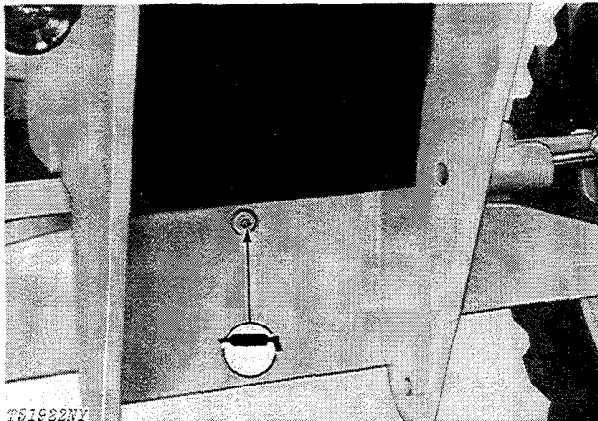

T61922NY

Fig. 31-Axle Pivot Pin (1 point)

Lubricant required

Yes No

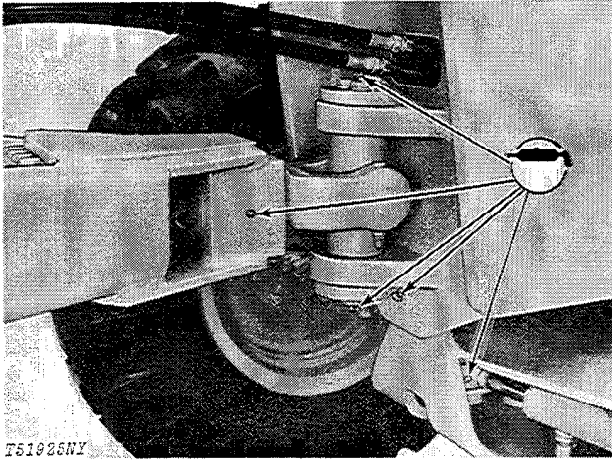

Fig. 34-Yoke and Retaining Pins (5 points)

Lubricant required Yes No

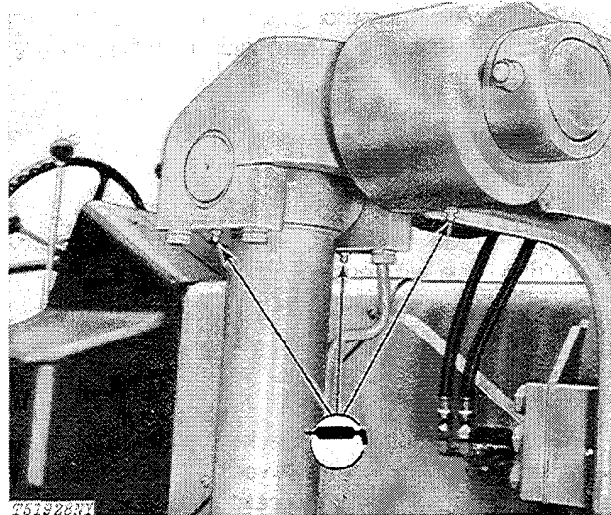

Fig. 37-Lift Cylinder Trunnions (6 points)

Lubricant required Yes No

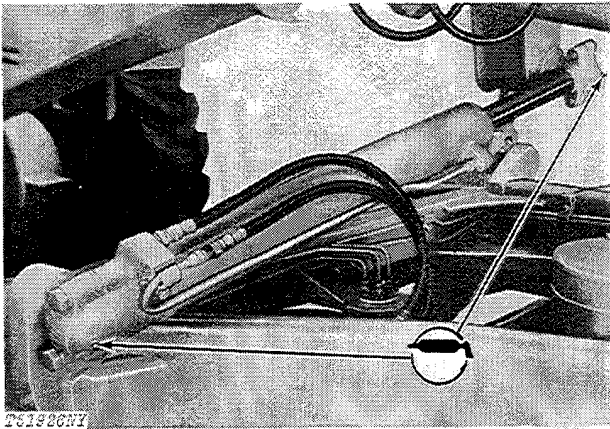

Fig. 35-Circle Side-Shift Cylinder (2 points)

Lubricant required Yes No

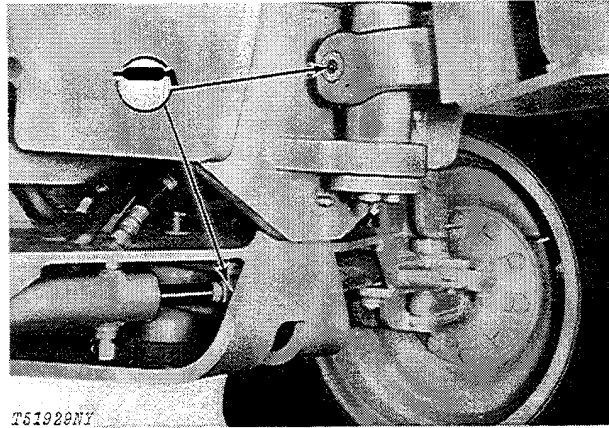

Fig. 38-Yoke and Steering Cylinder (2 points)

Lubricant required Yes No

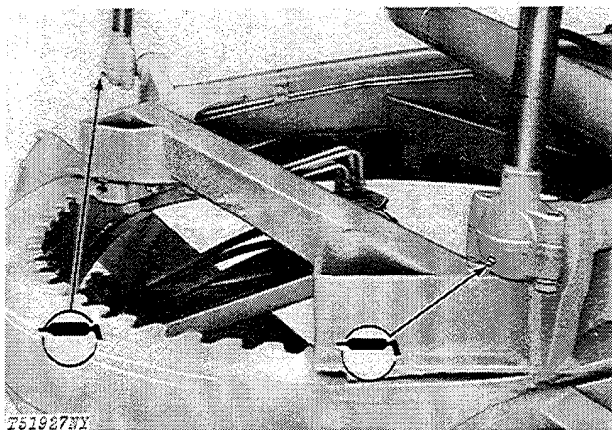
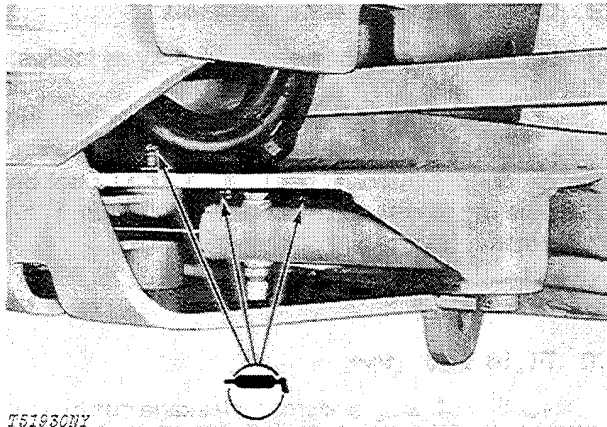

Fig. 36-Lift Cylinders (2 points)

Lubricant required Yes No



T51930NY

Fig. 39-Steering Arms (3 points)

Lubricant required Yes No

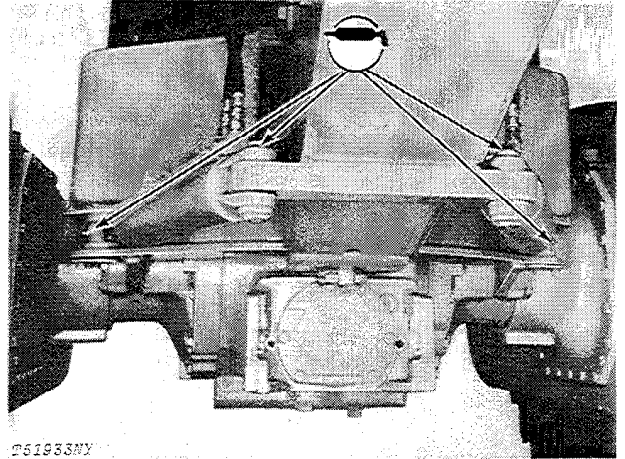

T51933NY

Fig. 42-Steering Cylinders (4 points)

Lubricant required Yes No

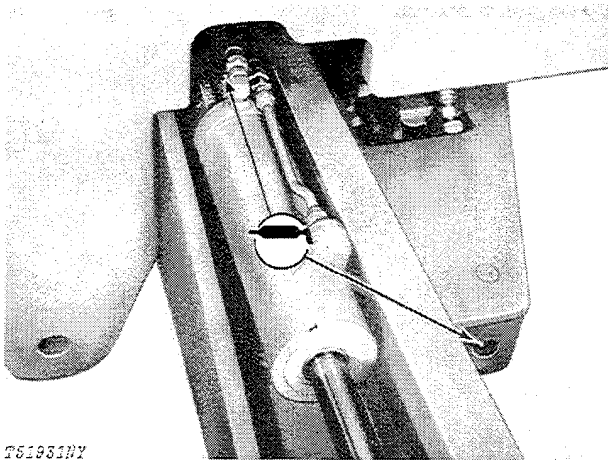

T51931NY

Fig. 40-Wheel Lean Cylinder and Pivot (2 points)

Lubricant required Yes No

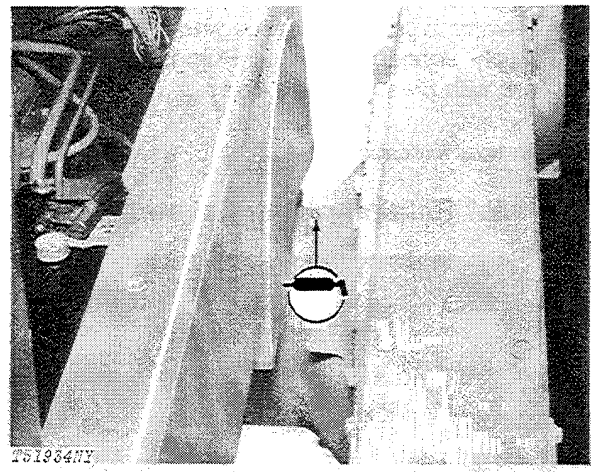

T51934NY

Fig. 43-Rear Axle Bearings (2 points)

Lubricant required Yes No

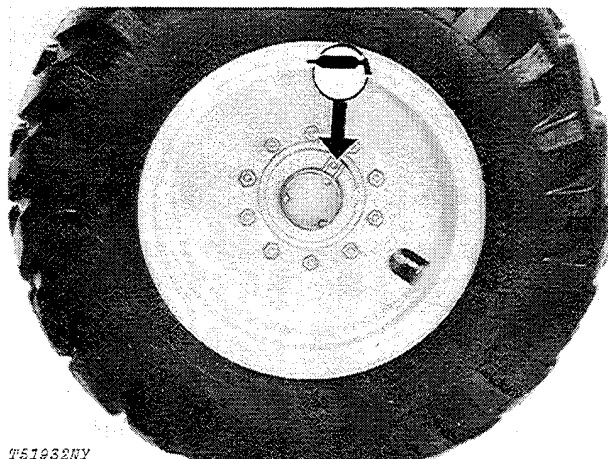

T51932NY

Fig. 41-Front Wheels (2 points)

Lubricant required Yes No

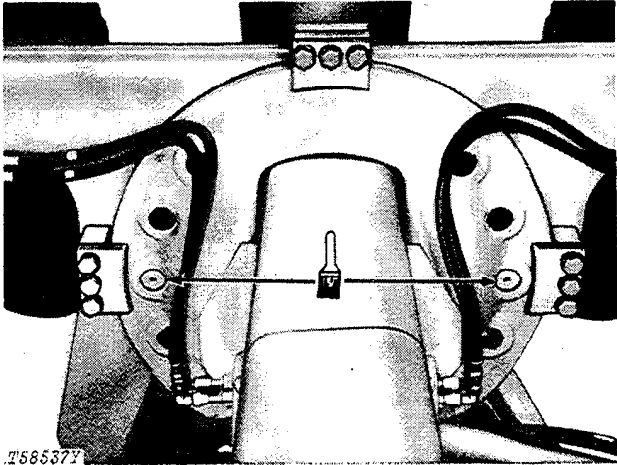

T58537Y

Fig. 44-Locking Pin Holes

Lubricate two locking pin holes.

Lower blade to ground. Disengage locking pins from holes. Apply John Deere Multi-Purpose Grease or equivalent with brush to each hole.

Locking pin holes lubricated Yes No

## 29. Check Accumulator Action

Check the accumulator reserve capacity as follows:

Start engine and run approximately one minute. Stop engine. Operate brake pedal twenty applications. After twenty applications, pedal travel should not be excessive with a firm but moderate pedal effort if the brake accumulator is functioning correctly.

Accumulator checked Yes No

## 30. Fluid Leakage

Check the following systems for leakage due to poor or faulty connections and broken hoses or lines.

A. Cooling system checked	Yes	No
B. Hydraulic system checked	Yes	No
C. Transmission system checked	Yes	No
D. Fuel system checked	Yes	No

## 28. Wheel Retaining Cap Screws

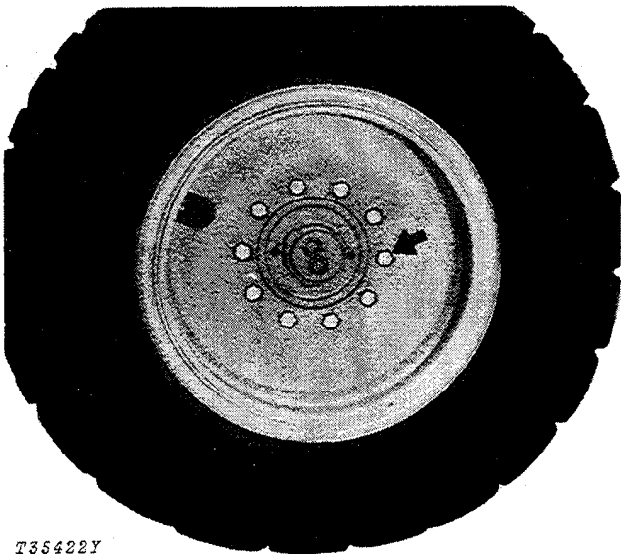

T35422Y

Fig. 45-Wheel Retaining Cap Screws



Check all wheel retainer cap screw torque. Tighten to 300 lb-ft.

Wheel retaining cap screws tightened Yes No

### 31. Accessible Hardware Torque Values

Check all accessible bolts and nuts for proper tightness. If hardware is loose, tighten it to the proper torque. The table below gives correct torque values for various bolts and cap screws. Most hardware used is high-strength (note dashes on hex. heads).

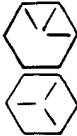
#### STANDARD TORQUE CHART

RECOMMENDED TORQUE IN LB - FT COARSE AND FINE THREADS			
	B	D	F
			
Bolt Diameter	Plain Head	Three Dashes	Six Dashes
1/4	Not used	10	14
5/16	Not used	20	30
3/8	Not used	35	50
7/16	35	55	80
1/2	55	85	120
9/16	75	130	175
5/8	105	170	240
3/4	185	300	425
7/8	160	445	685
1	250	670	1030
1-1/8	330	910	1460
1-1/4	480	1250	2060

T28433

Fig. 46-Torque Chart

The types of bolts and cap screws are identified by head markings as follows:

Plain Head: regular machine bolts and cap screws.

3-Dash Head: tempered steel high-strength bolts and cap screws.

6-Dash Head: tempered steel extra high-strength bolts and cap screws.

Machine bolts and cap screws 7/8-inch and larger are sometimes formed hot rather than cold, which accounts for the lower torque.

All accessible hardware torqued

Yes No

### 32. Final Check

The final predelivery procedure is the overall clean-up of the motor grader. Make the motor grader LOOK like a new motor grader with the proper touch-up of chipped paint and a good wash job. Deliver to the customer a motor grader anyone would be proud to own.

## DELIVERY SERVICE

A thorough discussion of the operation and service of this motor grader at the time of delivery helps to assure complete customer satisfaction. Proper delivery should be an important phase of a dealer's program. A portion of the John Deere Delivery Receipt emphasizes the importance of proper delivery service.

Many complaints arise because the owner was not shown how to operate and service the new motor grader properly. Devote enough time, at the customer's convenience, to introduce the owner to the new motor grader and explain how to operate and service it.

The following procedure is recommended before the service technician and owner complete the delivery acknowledgments portion of the Delivery Receipt.

Use the operator's manual as a guide to be sure that the owner understands these points thoroughly.

1. The importance of safety.
2. The importance of lubrication and periodic services.
3. The importance of the break-in period.
4. Controls and instruments.
5. How to start and stop the engine.
6. All functions of the hydraulic system.

After explaining and demonstrating the above features, have the owner sign the Delivery Receipt and give the owner the operator's manual.

## AFTER-SALE INSPECTION

The purchaser of a new John Deere motor grader is entitled to a free inspection at some mutually agreeable time within the warranty period after the equipment has been "run in," usually after 50 to 100 hours of motor grader operation. The terms of this after-sale inspection are outlined on the customer's John Deere Delivery Receipt.

The purpose of this inspection is to make sure that the customer is receiving satisfactory performance from the motor grader. At the same time, the inspection should reveal whether or not the motor grader is being operated, lubricated, and serviced properly.

If the recommended after-sale service inspection is followed, the dealer can eliminate a needless volume of service work by preventing minor irregularities from developing into serious problems later on. This will promote strong dealer-customer relations and present the dealer an opportunity to answer questions that may have arisen during the first few days of operation.

During the inspection service, the dealer has the further opportunity of promoting the possible sale of other new equipment.

Check operation of all controls and instruments for freedom of movement and correct operation.

## 1. Engine Crankcase Oil and Filter

**NOTE:** Check with the customer if oil has been changed and filter replaced before performing this service.

Normal sequence of service is as follows:

Oil and Filter Change - after first 100 hours  
- every 200 hours thereafter

If changed, record information below:

Approximate hours at change

If not, change as follows:

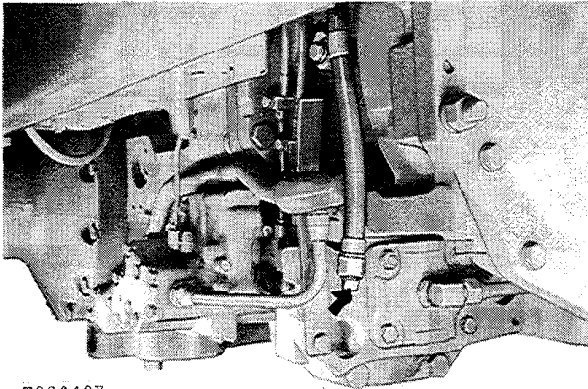

Fig. 47-Crankcase Drain Plug

Drain crankcase when the oil is hot. Remove the drain plug. Drain all oil.

While oil is draining, replace filter as follows:

Remove filter. (A, Fig 48) (turn counterclockwise).

Clean mounting surface.

Apply film of oil to sealing ring of new filter.

Tighten filter until sealing ring touches mounting surface.

Turn an additional 1-1/2 turns.

Do not overtighten.

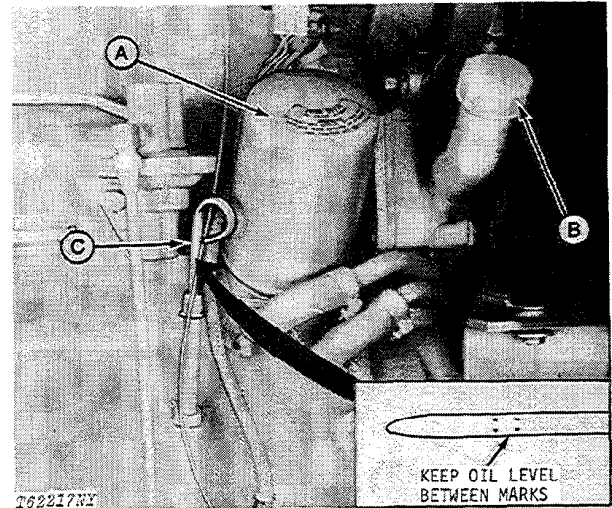

A—Oil Filter  
B—Filler Cap

C—Dipstick

Fig. 48-Changing Crankcase Oil and Filter

Install crankcase drain plug.

Fill crankcase with new oil of proper viscosity (B, Fig. 48). Capacity is 12 quarts with filter.

Run engine a short time and check for leaks at filter base and engine crankcase drain plug. Tighten filter if required.

Stop engine. Check oil level (C, Fig. 48).

Crankcase oil changed  
Oil filter changed

Yes	No
Yes	No

## 2. Transmission-Hydraulic System Oil Level and Filter Elements

**NOTE:** Before checking oil level find out if customer has changed transmission filter element (first 50 hours service).

If changed at an earlier date, record information below:

Approximate hours at change \_\_\_\_\_

If not, change as follows:

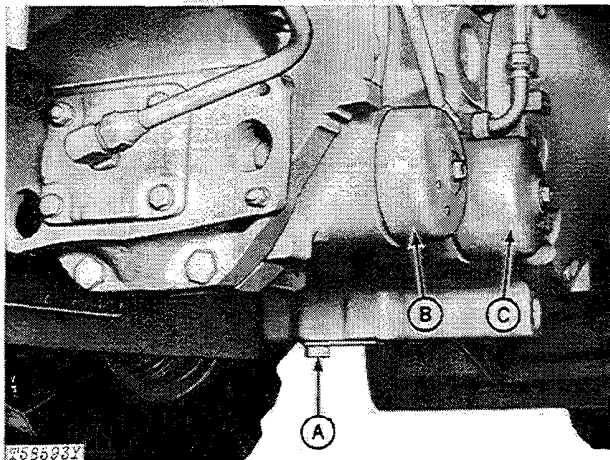

A—Drain Plug  
 B—Transmission Filter  
 C—Hydraulic Filter

Fig. 49-Transmission-Hydraulic System Filters

Stop the engine. Remove the transmission oil filter (B, Fig. 49) cover. Pull out the oil filter element and install new filter element. Replace the filter cover gasket. Install and tighten the filter cover to 55 lb-ft (77 Nm). Check the oil level.

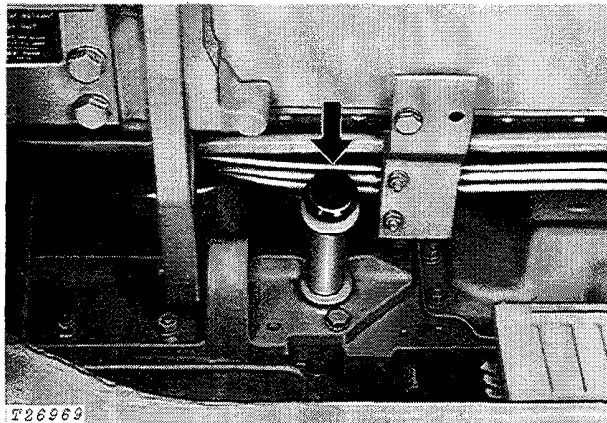

Fig. 50-Transmission-Hydraulic System Filler Cap and Dipstick

Be sure dipstick has been fully inserted before checking oil level. Do not start engine unless oil is near top mark on dipstick.

If oil is needed, add John Deere HY-GARD Oil or equivalent. Do not overfill.

Transmission filter changed	Yes	No
Oil level checked	Yes	No
Oil added	_____	qts.

## 3. Tandem Drives

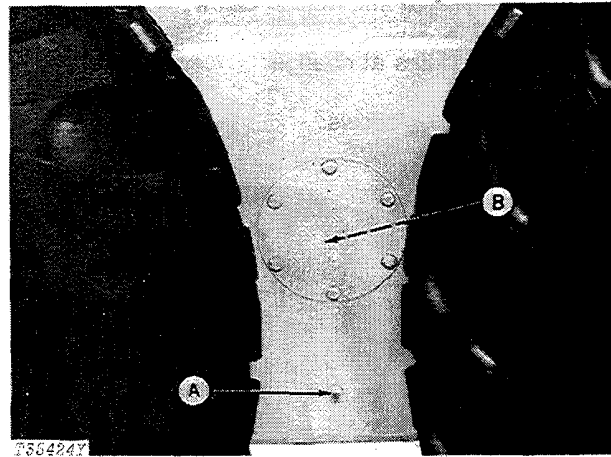

A—Oil Level Plug  
 B—Main Drive Sprocket Retainer

Fig. 51-Tandem Drives

With the grader on a level surface, check oil in both tandems by removing the oil level plug. Oil should be level with the check plug hole. If necessary, add John Deere HY-GARD Oil or equivalent through one of the holes under the inspection plates.

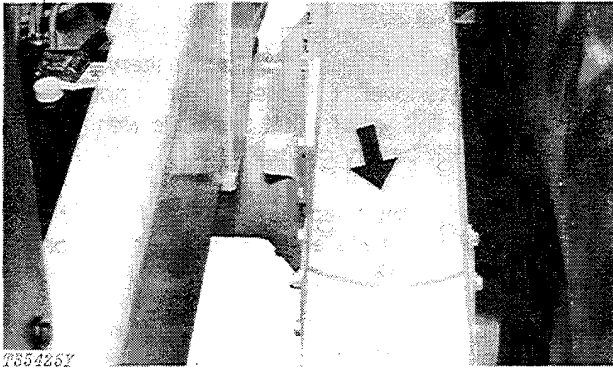
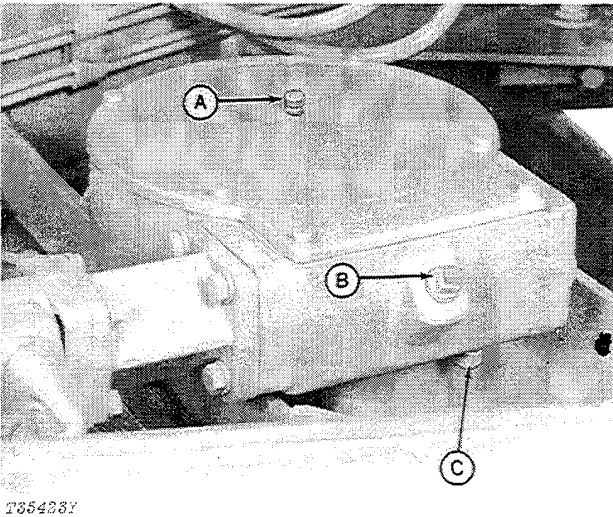

Fig. 52-Tandem Drive Inspection Plate

Tandem drives oil level checked Yes No  
 Oil added \_\_\_\_\_qts.

#### 4. Circle Drive Gear Box



A—Vent C—Drain Plug  
 B—Oil Level and Filler Plug

Fig. 53-Circle Drive Gear Box

With the blade resting on level ground, check the circle drive gear box oil level by removing the oil level plug. Oil should be level with the plug hole. If necessary, add John Deere SCL Gear Oil or equivalent. Replace filler plug.

Circle drive gear box oil level checked Yes No  
 Oil added \_\_\_\_\_qts.

#### 5. Precleaner

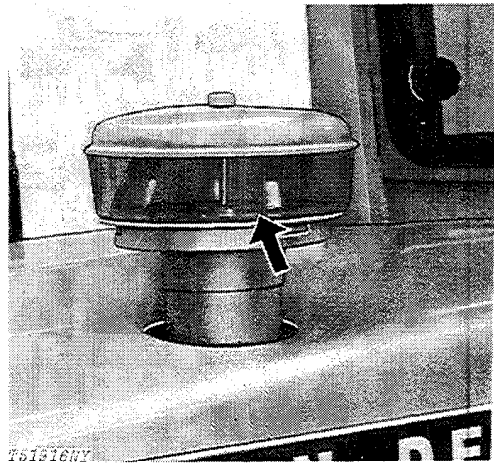
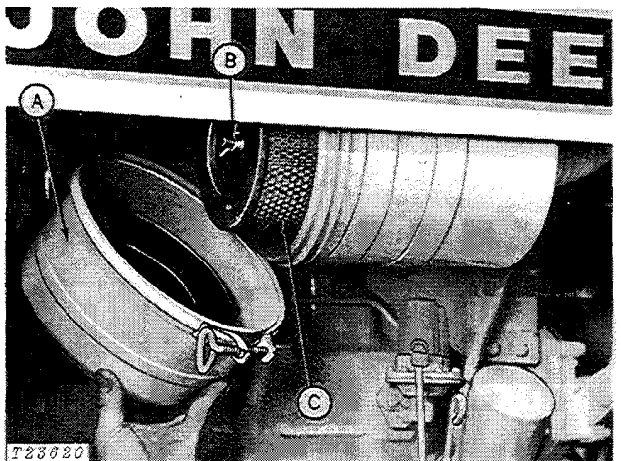

Fig. 54-Precleaner

Check precleaner bowl. Clean if necessary.

Precleaner checked Yes No

#### 6. Air Cleaner



A—Dust Cap  
 B—Wing Nut

C—Primary Element

Fig. 55-Air Cleaner

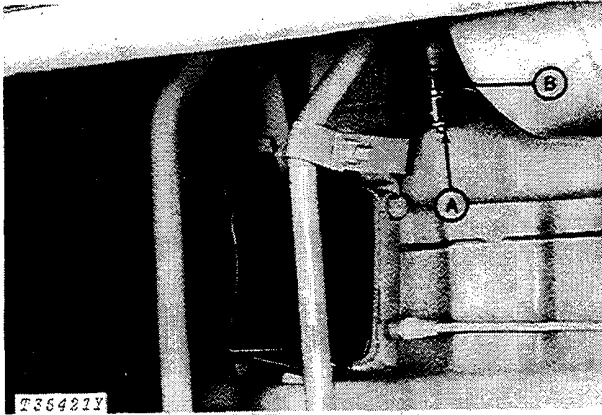

A—Reset Button      B—Red Signal

Fig. 56-Restriction Indicator

Check air cleaner restriction indicator. If indicator shows red, check elements. If only primary element is dirty, clean the element. If safety element is dirty, replace both elements.

Air cleaner checked	Yes	No
Elements replaced	Yes	No

### 7. Radiator

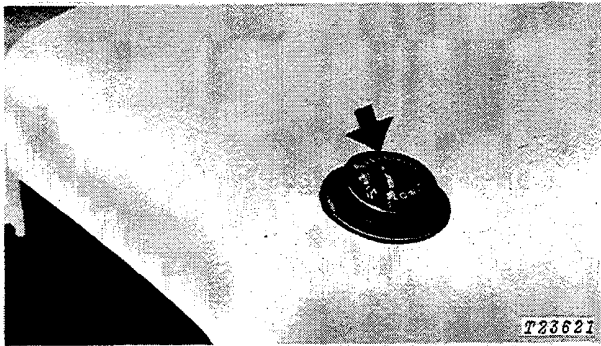

Fig. 57-Radiator Filler Cap

**CAUTION:** Remove the radiator filler cap only when the coolant temperature is below the boiling point. Then loosen the cap slightly to the stop to relieve pressure before removing the cap completely.

Check coolant level. Maintain 4 inches below the top of the filler neck.

Radiator coolant level checked	Yes	No
Coolant or anti-freeze added	_____	qts.

### 8. Batteries

Remove foreign material from top of battery. Check battery electrolyte level. If distilled water is not available, use clean soft water. Coat terminals with petroleum jelly. Check battery connections.

**IMPORTANT:** Never add water to battery in freezing weather unless engine will be run 2 or 3 hours.

Water added	Yes	No
Battery connections checked	Yes	No

### 9. Tire Pressure

Check the air pressure in all the tires with an accurate gauge having 1 psi graduations.

**IMPORTANT:** All tires must be inflated to the same pressure.

Adjust pressure in tires to the following specifications:

Tire size	Ply Rating	Inflation Pressures psi
13.00-24	8	25
13.00-24	10	30
15.5-25	8	25

Tire pressure checked	Yes	No
-----------------------	-----	----

### 10. Fuel Tank

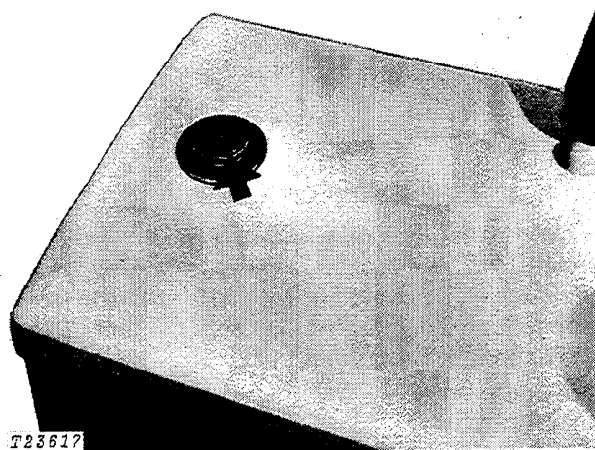

Fig. 58-Fuel Tank Filler Cap



Fig. 59-Fuel Gauge

Check fuel gauge. Turn on key switch and check for movement of indicator on gauge. If no movement is noted, add a small amount of fuel and repeat procedure.

If no indicator movement is noted, gauge is not functioning.

Fuel gauge functional Yes No

### 11. Fuel Tank Sump

Open fuel tank drain cock. Drain liquid for several seconds. Close drain cock.

*NOTE: Fuel tank sump drain is located on the bottom of the fuel tank.*

Fuel sump drained Yes No

### 12. Fuel Filter

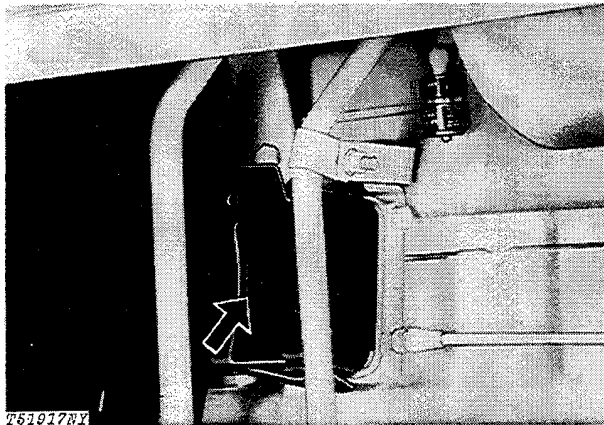

Fig. 60-Fuel Filter

Check fuel filters for sediment. Drain if necessary.

Bleed fuel system as follows:

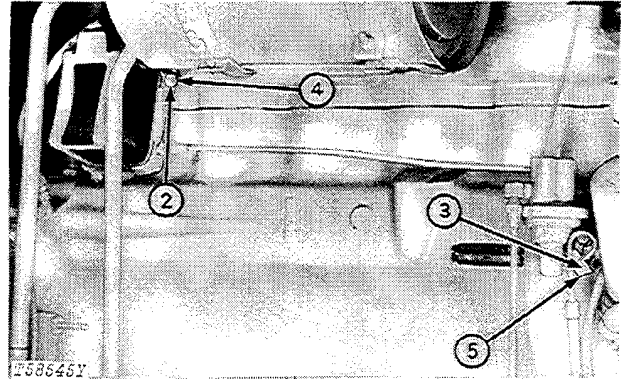

Fig. 61-Bleeding Fuel System

- 1 - Be sure fuel tank has sufficient fuel.
- 2 - Loosen the bleed screw.
- 3 - Pump the primer lever until fuel without air bubbles flows from the bleed screw.
- 4 - Tighten the bleed screw.
- 5 - Push the primer lever down.

*NOTE: If primer does not pump fuel and no resistance is felt at upper portion of lever stroke, turn engine slightly with starter to change fuel pump cam position.*

Sediment present in filter Yes No  
 Fuel system bled Yes No

### 13. Lubrication

Check each lubrication point shown in the following pages. Lubricate, if necessary, with several strokes of John Deere Multi-Purpose Grease or equivalent.

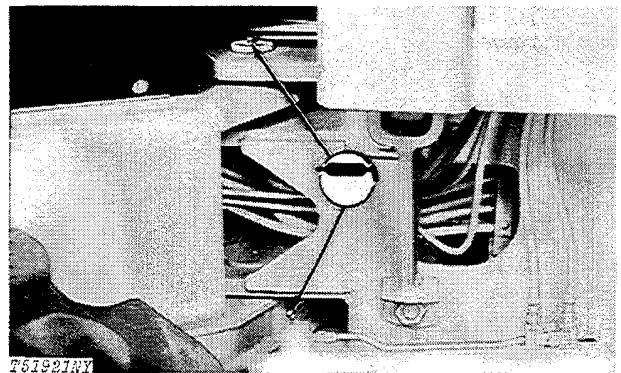

Fig. 62-Frame Pivot (2 points)

Lubricant required Yes No

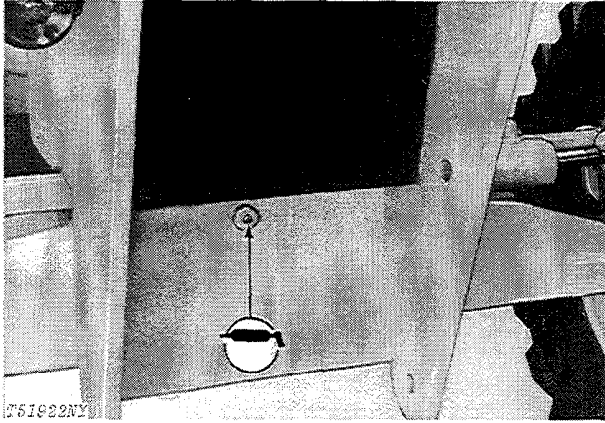

Fig. 63-Axle Pivot (1 point)

Lubricant required

Yes No

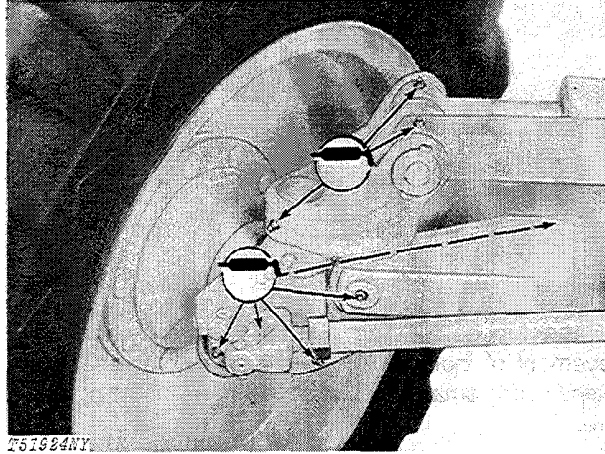

Fig. 65-Left Front Axle (8 points)

Lubricant required

Yes No

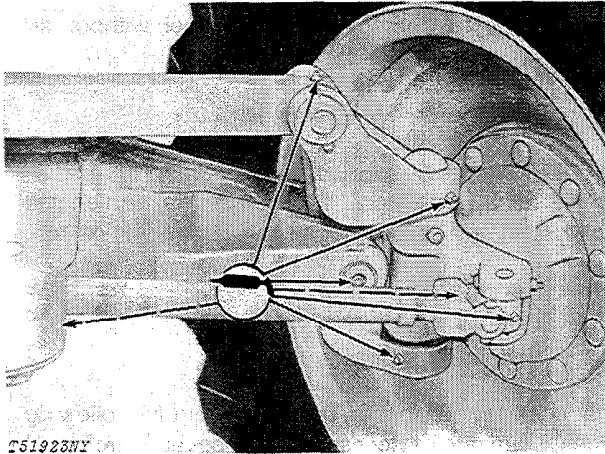

Fig. 64-Right Front Axle (7 points)

Lubricant required

Yes No

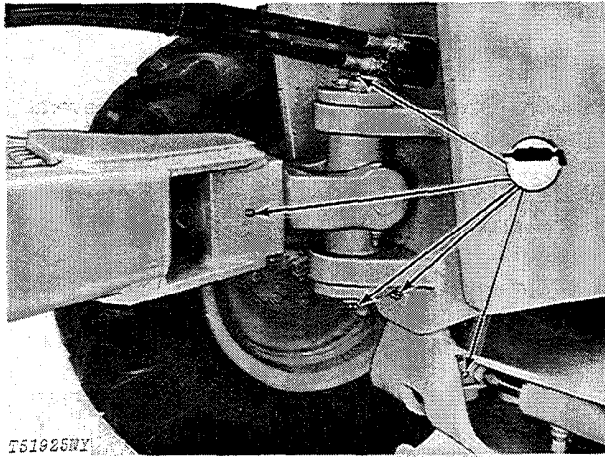

Fig. 66-Yoke and Retaining Pins (5 points)

Lubricant required

Yes No

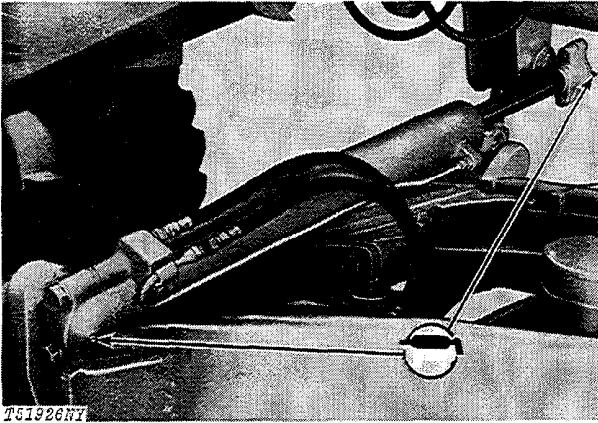

Fig. 67-Circle Side Shift Cylinder (2 points)

Lubricant required Yes No

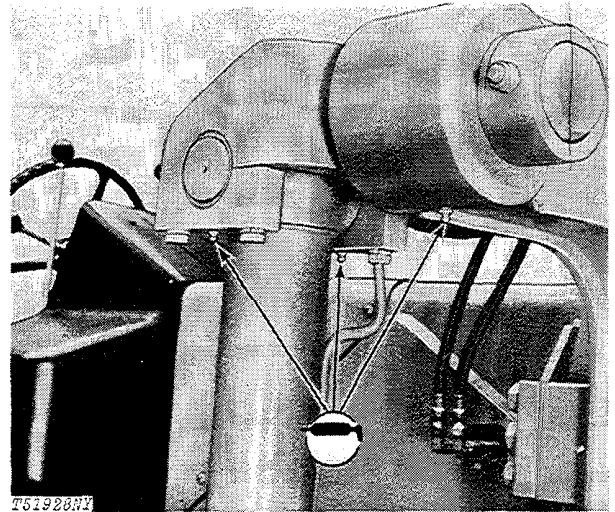

Fig. 69-Lift Cylinder Trunnions (6 points)

Lubricant required Yes No

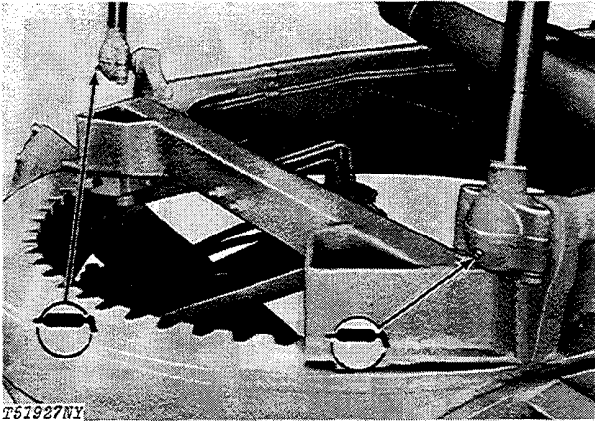

Fig. 68-Lift Cylinder (2 points)

Lubricant required Yes No

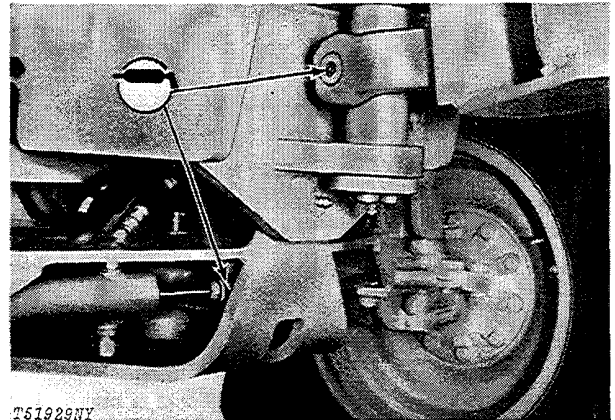
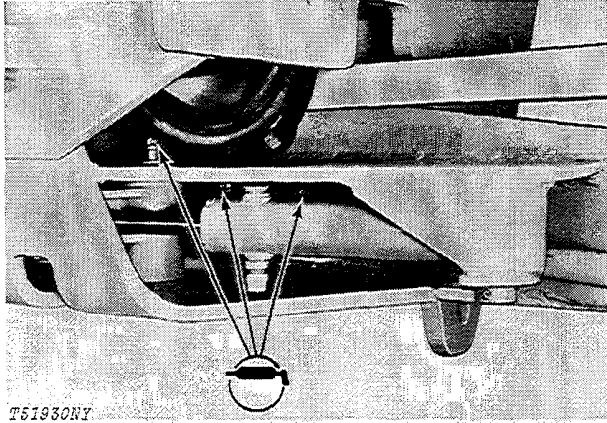

Fig. 70-Yoke and Steering Cylinder (2 points)

Lubricant required Yes No



T51930NY

Fig. 71-Steering Arms (3 points)

Lubricant required Yes No

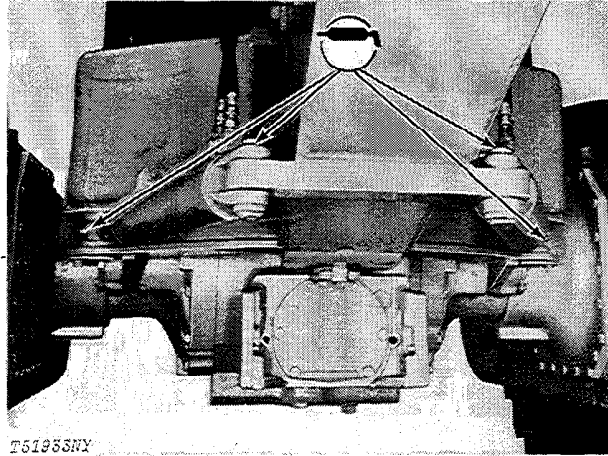

T51933NY

Fig. 74-Steering Cylinders (4 points)

Lubricant required Yes No

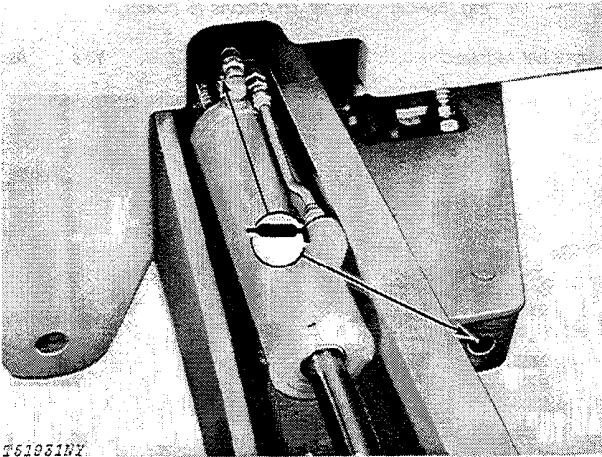

T51931NY

Fig. 72-Wheel Lean Cylinder and Pivot (2 points)

Lubricant required Yes No

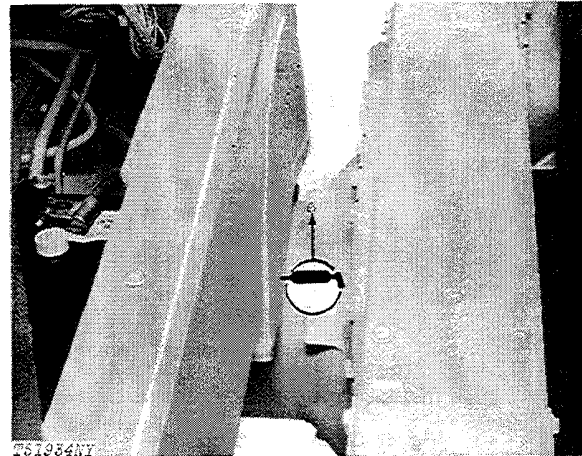

T51934NY

Fig. 75-Rear Axle Bearings (2 points)

Lubricant required Yes No

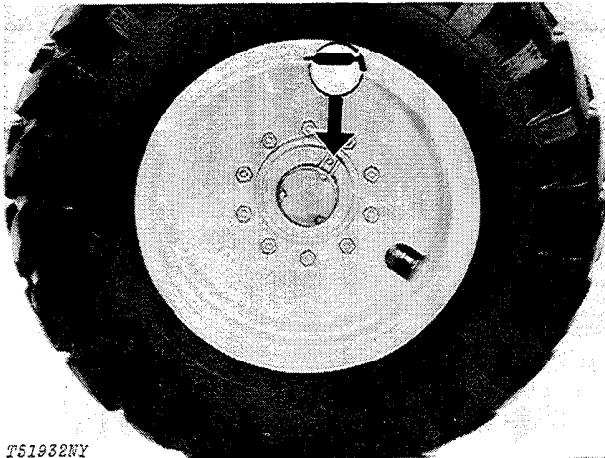

T51932NY

Fig. 73-Front Wheels (2 points)

Lubricant required Yes No

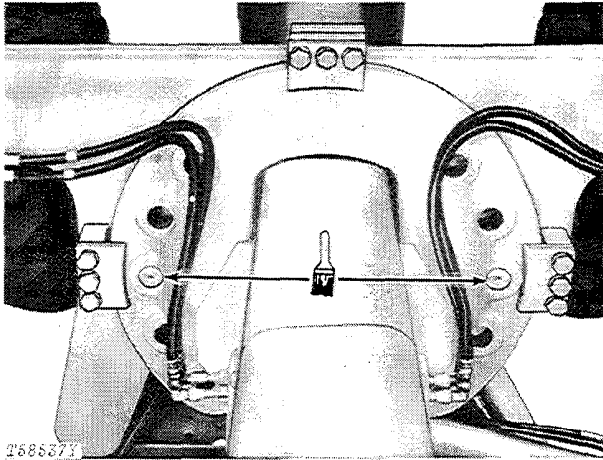

Fig. 76-Locking Pin Holes

Lubricate two locking pin holes.

Lower blade to ground. Disengage locking pins from holes. Apply John Deere Multi-Purpose Grease or equivalent with brush to each hole.

Locking pin holes lubricated Yes No

#### 14. Air Intake Hoses

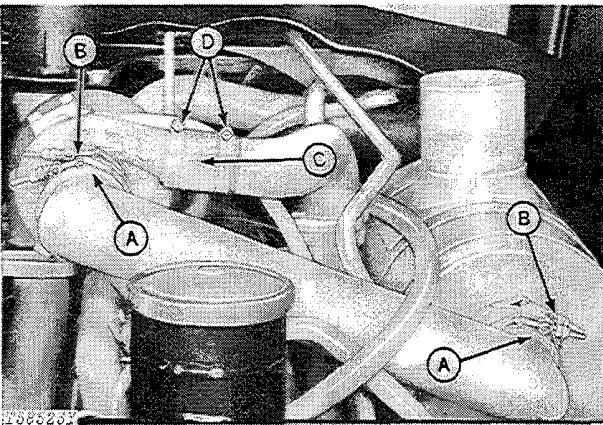

A—Air Intake Hose  
 B—Air Intake Hose Clamps  
 C—Turbocharger Inlet Hose  
 D—Turbocharger Inlet Hose Clamps

Fig. 77-Air Intake Hoses and Clamps

Check hoses (A) for cracks. Replace if necessary. Tighten clamps (B). Also check turbocharger inlet hose (C) and clamps (D).

Air intake hoses checked Yes No

#### 15. Alternator-Fan Belts

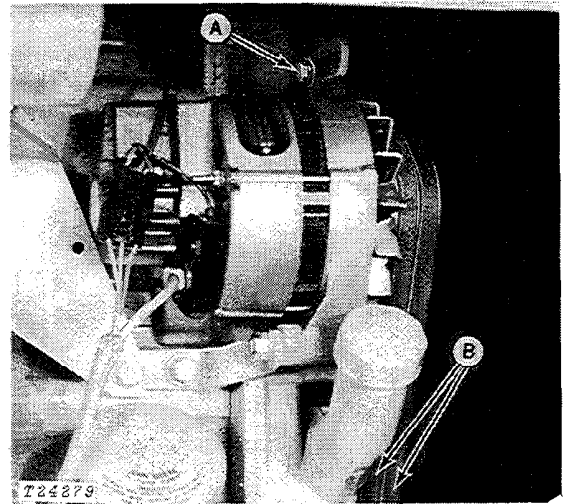

A—Adjusting Cap Screw B—Alternator-Fan Belts

Fig. 78-Alternator-Fan Belts

Alternator-fan belt should deflect 3/4-inch when 20 pounds of force is applied to the belt midway between the two pulleys. Check front belt only. If a belt gauge is used, tighten new alternator belt to 100 pounds strand tension. After 3 minutes of operation, tension should be 90 pounds minimum.

**IMPORTANT:** Do not pry on the rear alternator housing as this may damage the alternator.

Alternator-fan belt tension \_\_\_\_\_ lbs strand tension  
 \_\_\_\_\_ inch deflection

#### 16. Engine Speeds

Warm up engine and attach a tachometer in the hour meter drive plug hole to check engine speeds.

No-load, fast idle speed should be 2450 rpm. Slow idle should be 900 rpm.

If engine speeds do not agree with the above adjust as follows:

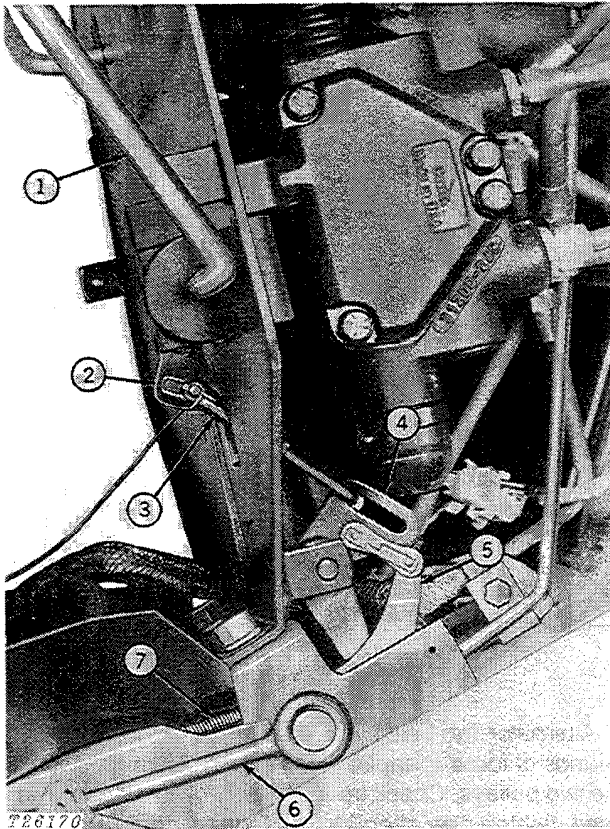

- 1—Hand Throttle Lever
- 2—Throttle Lever
- 3—Throttle Rod and Clevis
- 4—Throttle Link
- 5—Foot Throttle Arm
- 6—Foot Throttle Pedal
- 7—Spring

Fig. 79-Hand and Foot Throttle Linkage

With the foot throttle linkage in the slow idle position, adjust the throttle cable so the lever on the pump overrides the slow idle position by 1/4 inch.

Pull the hand throttle lever (1, Fig. 79) to the most rearward position and adjust the throttle rod and clevis linkage (3) on the hand throttle lever (1) to the shortest length without moving the foot throttle linkage.

Put the hand throttle lever in the most forward position. The lever on the pump should be in the fast idle override position. Fast idle override is 1/4 inch.

Engine speeds checked	Yes	No
Adjustments required	Yes	No

## 17. Parking Brake

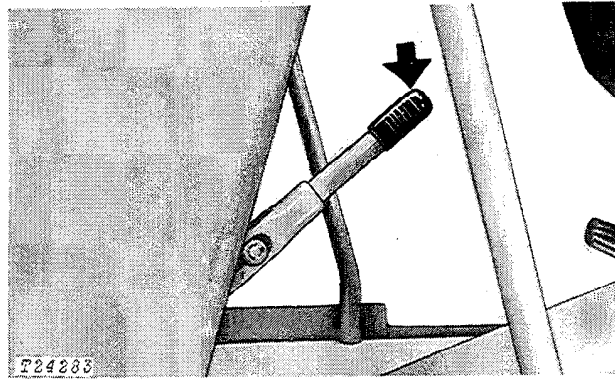

Fig. 80-Parking Brake Lever

Check parking brake adjustment.

A lifting force of 75 lbs (minimum) is required to set the parking brake lever.

If parking brake adjustment is required, adjust as follows:

The parking brake lever has a built-in adjustment knob. Turn the knob clockwise to adjust the brake.

When the end of this adjustment is reached, turn the knob counterclockwise several turns to release the brake, and adjust the clevis linkage.

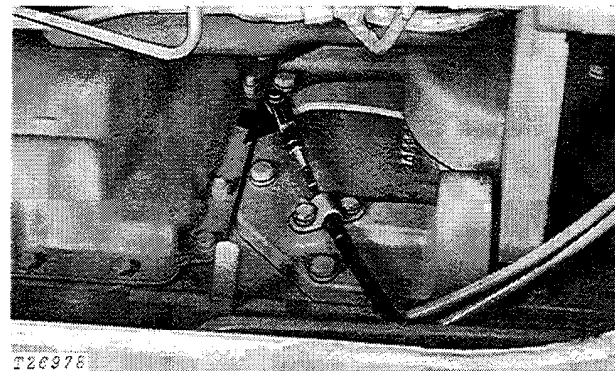
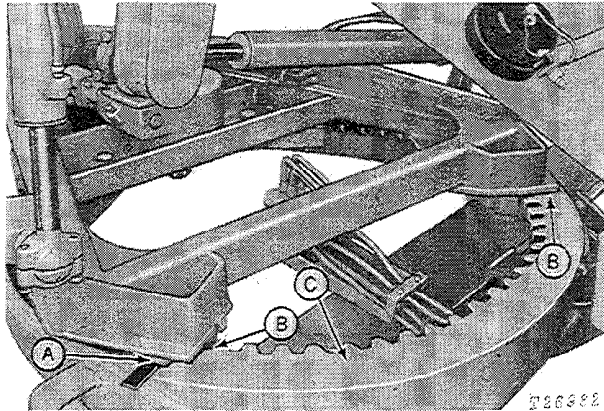

Fig. 81-Parking Brake Adjustment

Remove the clevis from brake arm and back off lock nuts. Turn clevis clockwise on brake cable to adjust brake. Tighten lock nuts and install clevis.

Parking brake checked	Yes	No
Adjustment required	Yes	No

### 18. Circle Adjustment



A—Wear Plate  
 B—0.02 to 0.08 Inch  
 C—Circle

Fig. 82-Circle Adjustment

#### Wear Plate-Circle Clearance

To adjust circle, position circle and blade assembly so blade is perpendicular to length of grader and centered on the circle. Raise the blade a couple of inches from the ground.

Adjust the circle support shim pack to obtain 0.02 to 0.08-inch clearance between the circle and each wear plate. Tighten support cap screws just enough so support is firmly against shim pack. Check and adjust one support at a time.

**NOTE:** Wear plates may be replaced if no further adjustment is possible.

Position the blade under the machine in such a manner that the moldboard can be sideshifted up against the front axle.

Loosen all circle support bolts.

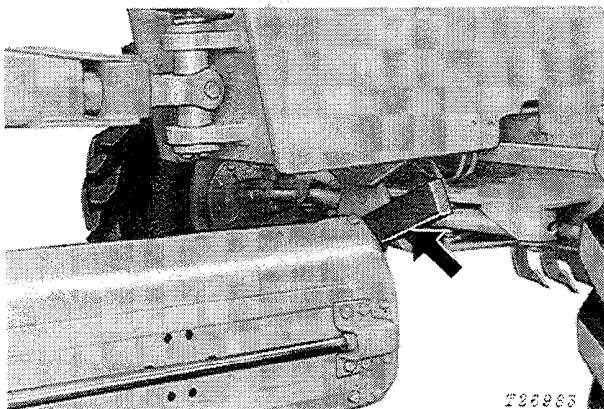
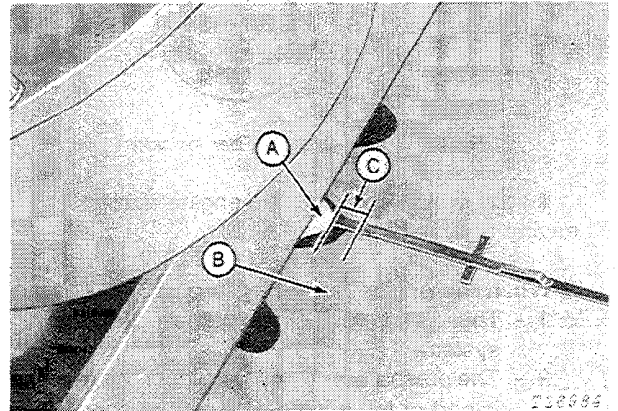

Fig. 83-Positioning Moldboard

Litho in U.S.A.

Place a wooden block (Fig. 83) between the end bit and the front axle. Force the circle back by sideshifting the moldboard against the wooden block.

The pinion tip-to-circle root distance should be a maximum of 0.35 inch (see below).



A—Pinion Gear  
 B—Circle  
 C—Maximum of 0.35 Inch

Fig. 84-Pinion Tip to Circle Adjustment

Sideshift moldboard back away from the wooden block slightly to relieve some pressure from the front circle support bolts. Tighten bolts snug and recheck the 0.35-inch maximum dimension.

Adjust the rear support shoes uniformly until they both just contact the circle teeth. Tighten each of the adjusting screws an additional 1/8 turn to snug the support shoe up against the circle teeth.

Tighten hardware to 670 lb-ft. and rotate circle 360 degrees in both directions. The 0.35-inch maximum dimension should be maintained after rotation. If, after initial adjustment, circle will not rotate a full 360 degrees without binding, loosen the rear circle supports and back them off slightly.

**NOTE:** The circle support shoes will polish the tips of the circle gear teeth and may initially peel small ribbons of steel off the bottom of the circle.

Circle adjustments required Yes No

If yes, explain \_\_\_\_\_

\_\_\_\_\_

\_\_\_\_\_

\_\_\_\_\_

\_\_\_\_\_

\_\_\_\_\_

## 19. Indicator Lights and Gauges

Check operation of indicator lights and gauges.



T23283

Fig. 85-Transmission Oil Filter Indicator Light

If light glows red while the engine is running, stop engine and determine cause.

When the engine is running and this light is on:

- 1 - There is a restriction in the transmission oil system.
- 2 - The pressure switch is not working. (This switch is part of the engine oil pressure sending unit.)
- 3 - The engine oil pressure is low.
- 4 - The engine oil is cold.

**NOTE:** This light glows when the key switch is in start position and the engine is off.



T 20466

Fig. 86-Alternator Indicator Light

The alternator indicator light glows red when the alternator is not charging. If the light goes on while the engine is running, stop engine and determine cause.

**NOTE:** Light should glow when key switch is in start position and engine off.

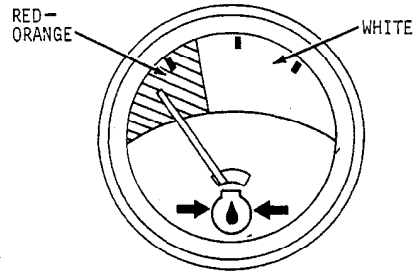

T62203N

Fig. 87-Engine Oil Pressure Gauge

During normal operations, the indicator hand should be in the white zone. If the indicator hand goes into the red-orange zone, stop the grader and check the engine oil level. If oil level is not low, check for restrictions in oil lines or incorrect viscosity oil.

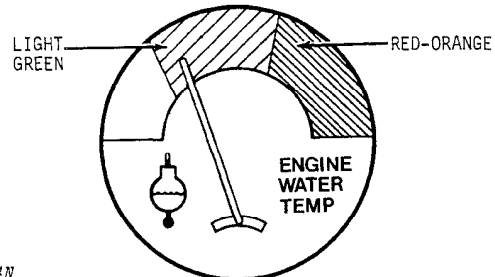

T62204N

Fig. 88-Engine Coolant Temperature Gauge

Normal operating temperature is indicated by the light green zone. If indicator hand enters red-orange zone, stop engine and determine the cause.

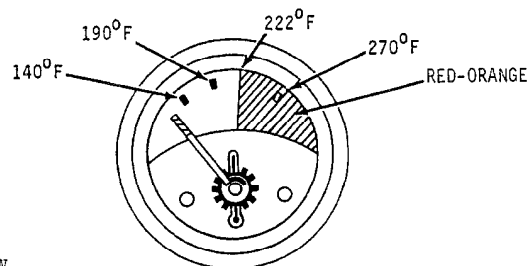

T62205N

Fig. 89-Transmission Oil Temperature Gauge

If indicator hand enters the red-orange zone, operate in a lower gear or speed. If hand remains in the red-orange zone, check transmission oil level or inspect for plugged oil cooler.

Indicator lights and gauges checked

Yes No

## 20. Transmission Operation

Check operation of transmission in all gears.

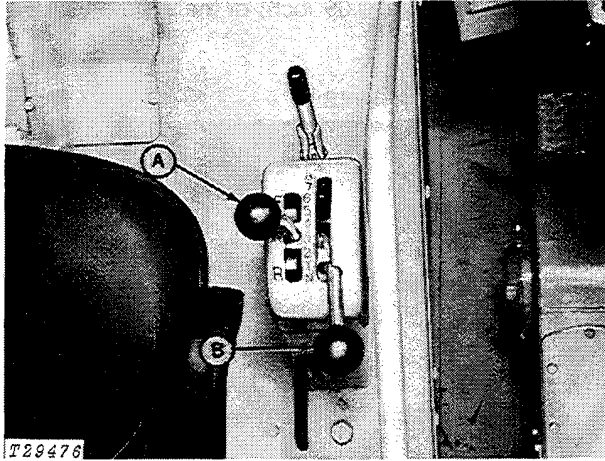

A—Forward-Reverse Lever B—Transmission Shift Lever

Fig. 90-Transmission Control Levers

Lever A - Release parking brake before shifting out of neutral. Change direction of travel "on the go" without declutching or shifting gears.

Lever B - Shift one gear at a time. When in 5th gear or higher, Lever A cannot be shifted into reverse.

Transmission operation checked Yes No

## 21. Charging System

When the motor grader is running and the alternator indicator light (see page 10-10-28) is not lit, the charging system is in proper working condition.

Charging system operational Yes No

## 22. Cylinder Ball and Socket Assemblies

The ball and socket assemblies on the lift cylinder rod ends and on the circle side-shift cylinder have shims which may be removed to compensate for wear.

Check looseness of sockets by lowering the blade to the ground and operating the cylinder back and forth without load. If movement exceeds 0.03 inch remove corresponding amounts of shims.

**NOTE:** Do not allow ball to bind in the socket.

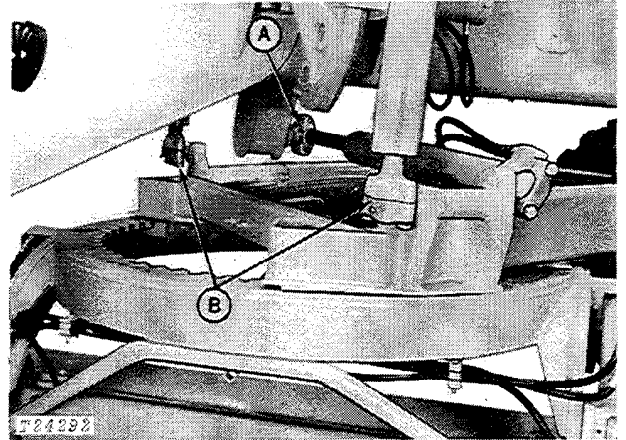

A—Circle Side-Shift Cylinder  
 B—Lift Cylinder Rod Ends

Fig. 91-Cylinder Ball and Socket

Socket looseness OK Yes No  
 If no, number of shims removed \_\_\_\_\_

## 23. Moldboard Retainers

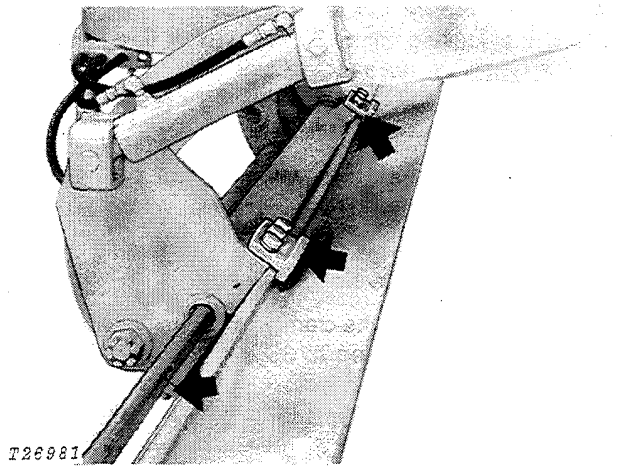
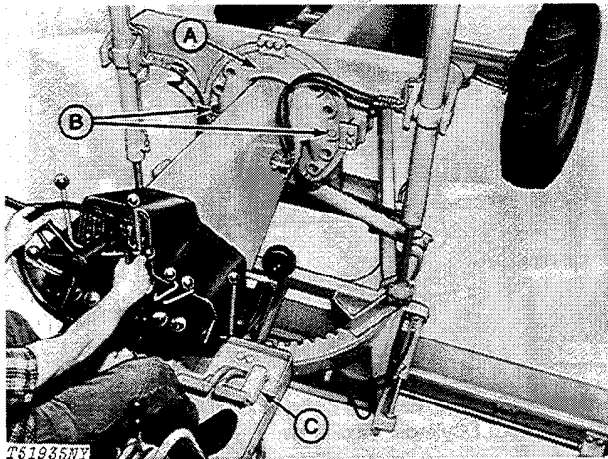

Fig. 92-Blade Side-Shift Rail Shims

The two upper guides on the blade side-shift rail have shims which may be removed to compensate for wear. Check the amount of looseness between the guides and the rail by slightly raising and lowering the blade to the ground. If excessive looseness is noticed, remove shims accordingly. Retain enough shims to allow blade to side-shift completely without binding.

Shims removed Yes No  
 If yes, indicate amount \_\_\_\_\_

## 24. Saddle Retaining Pins



A—Saddle Pivot  
 B—Saddle Retaining Pins  
 C—Locking Pin

Fig. 93-Saddle Retaining Pins (ROPS Canopy Removed for Illustration Purposes Only)

When the locking pin plunger (C, Fig. 93) is depressed the locking pins (B, Fig. 93) should retract from the holes in the saddle pivot (A, Fig. 93). The saddle may have to be "rocked" slightly (using the lift cylinders) to unload the locking pins.

When the locking pin plunger is released the locking pin should go back into the hole in the lift arm.

Visually check if pin is in hole. Also check if the locking pin plunger travels freely.

Check the torque on the clamp attaching bolts on the locking pin barrel. Tighten to 35 lb-ft.

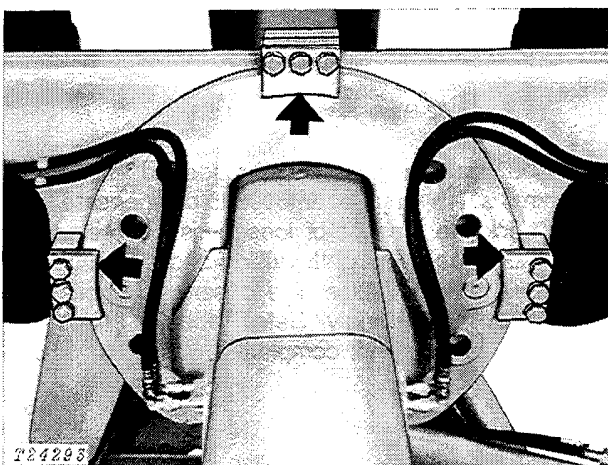

Fig. 94-Guide Shoes

Three adjustable guide shoes are located on the saddle. Shims located between the three guide shoes and the saddle can be removed or installed to control the clearance (0.02 to 0.09 inch) of the saddle in the guides.

## 25. Hydraulic Brakes

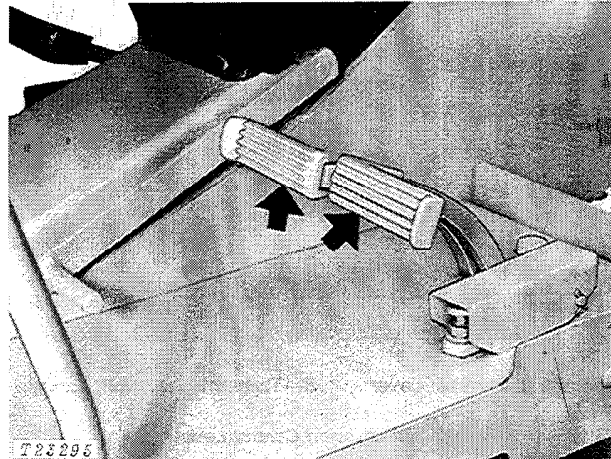
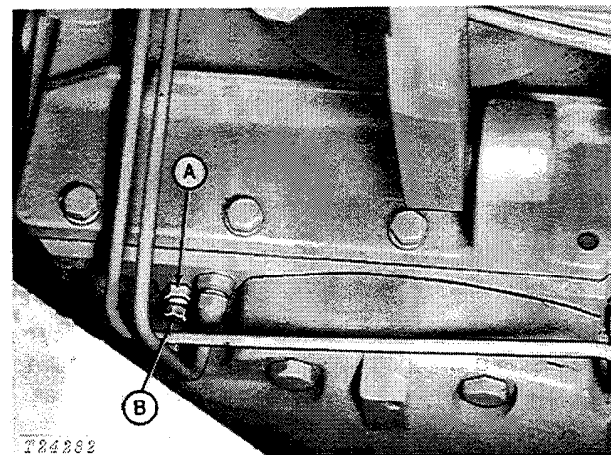

Fig. 95-Brake Pedals

Check brake system for leaks or improper operation. Put grader in gear and depress brake pedal. Moderate pedal force should hold grader in place.

If pedal force does not hold grader in place, pedal feels spongy or bottoms out, repair is required, or system may require bleeding as follows:



A—Lock Nut  
 B—Bleed Screw

Fig. 96-Bleed Screw

**NOTE:** This procedure requires two service technicians.

1. Lower all equipment to ground.
2. Stop engine.
3. Loosen lock nut on each bleed screw. Open bleed screw one turn. Tighten lock nut.

4. Hold brake pedals down to release accumulator pressure. Release pedals.
5. Run engine at slow idle.
6. Hold brake pedals down two minutes minimum.
7. Loosen lock nuts. Tighten bleed screws. Tighten lock nuts. Release pedals.
8. Pedal must feed solid. If not, bleed brakes again.

Brake pedal action OK	Yes	No
Bleeding required	Yes	No

## 26. Accumulator Action

Check the accumulator reserve capacity as follows:

Before starting engine, operate brake pedal several times. Excessive pedal travel means the accumulator has no reserve capacity.

Start engine and run approximately one minute. Stop engine. Operate brake pedal twenty applications. After twenty applications, pedal travel should not be excessive with a firm but moderate pedal effort if the brake accumulator is functioning correctly.

Accumulator functioning OK	Yes	No
----------------------------	-----	----

## 27. Check Cap Screw Torque

**NOTE:** If the following torque values are higher than your torque wrench is capable of measuring, use the following formula to determine the correct values while using a torque wrench extension.

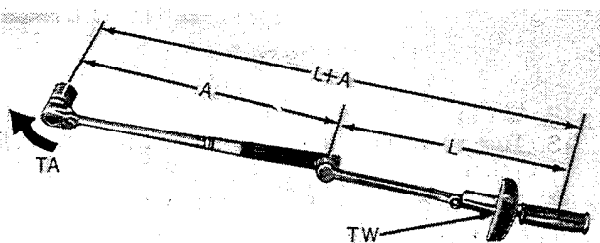

$$TW = Ta \times \frac{L}{L + A}$$

TW = Torque wrench reading - lb-ft  
 Ta = Required torque - lb-ft  
 L = Length (in feet) of torque wrench  
 A = Length (in feet) of extension

Fig. 97-Calculating Torque with an Extension

Check the following cap screw torque values:

Wheel retaining cap screws. Tighten to 300 lb-ft.

Wheel retaining cap screws tightened	Yes	No
--------------------------------------	-----	----

Saddle to saddle mounting cap screws. Tighten to 445 lb-ft.

Saddle to saddle mounting cap screws tightened	Yes	No
--	-----	----

Circle supports to draft frame cap screws. Tighten to 670 lb-ft.

Circle supports to draft frame cap screws tightened	Yes	No
---	-----	----

## 28. Accessible Hardware Torque Values

If hardware is loose, tighten it to the proper torque. See page 10-10-15 for torque chart.

All accessible loose hardware torqued	Yes	No
---------------------------------------	-----	----

## 29. Toe-In

### Checking Toe-In

Check toe-in regularly.

1. Park the grader on a level surface.
2. Use the blade or scarifier hydraulics to lift the front wheels off the ground. Block the front axle.

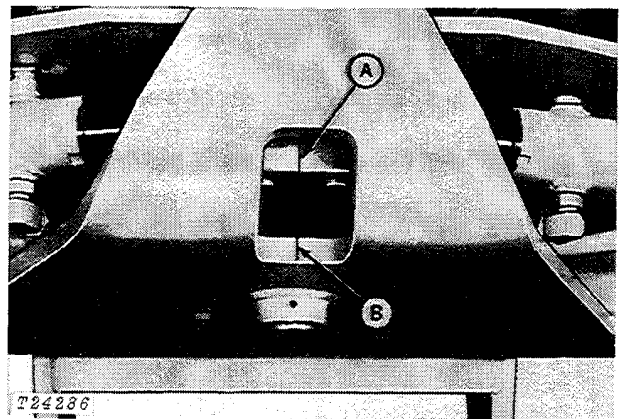

A—Bell Crank Centerline

B—Axle Centerline

Fig. 98-Aligning Centerlines

3. Line up the center mark on the bell crank with centerline on axle as shown.

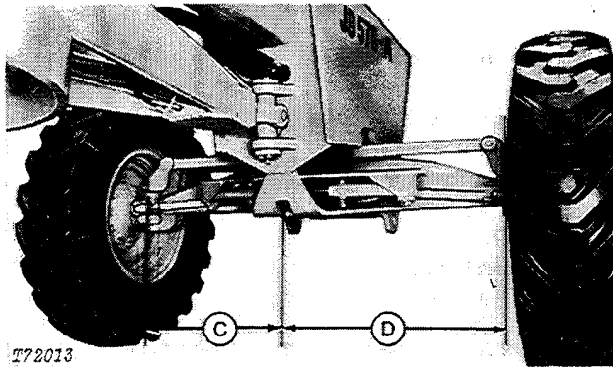

Fig. 99-Measuring Lines

4. Distance C (axle centerline to left tie rod pin) should be within 0.1 in. (2.5 mm) of distance D (centerline to right tie rod pin).
5. Measure distances E and F from floor to axle centerline.

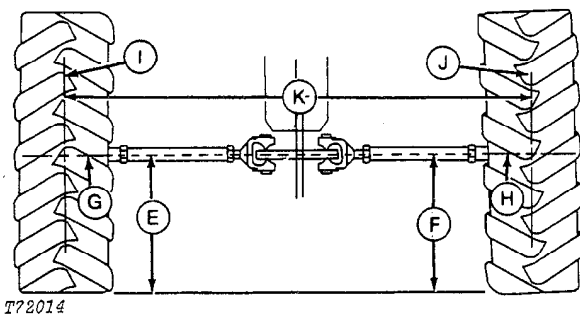

Fig. 100-Drawing Lines

6. Draw lines G and H on rear of tires.
7. Draw lines I and J at center of each tire.
8. Measure distance K at G and H height.

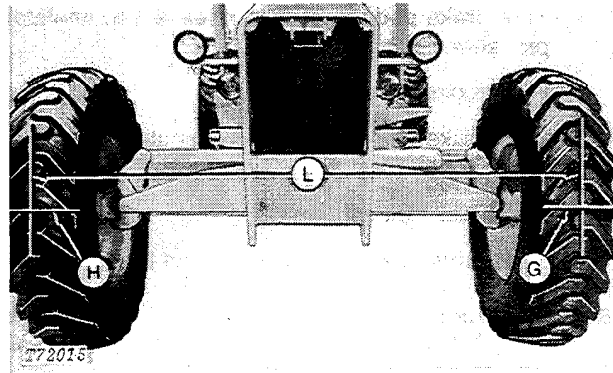

Fig. 101-Measuring Lines

9. Turn tires 180° so G and H are at axle centerline height in front of machine.
10. Measure distance L at G and H height.
11. Distance L must be 0 to 0.5 in. (0 to 13 mm) less than distance K.

### Adjusting Toe-In

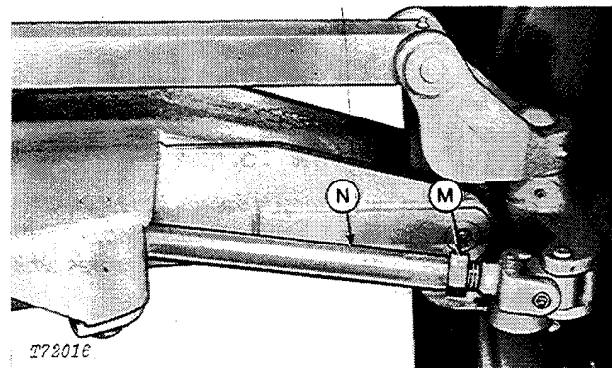

Fig. 102-Adjusting Toe-In

12. Loosen tie rod nuts (M).
13. Turn tie rods (N) the same number of turns until toe-in is correct.
14. Tighten nuts to 330 lb-ft (462 N-m).

Toe-in checked Yes No

### 30. Fluid Leakage

Check the following systems for leakage due to poor or faulty connections and broken hoses or lines.

A. Cooling system checked	Yes	No
B. Hydraulic system checked	Yes	No
C. Transmission system checked	Yes	No
D. Fuel system checked	Yes	No

## Group 15

# TUNE-UP AND ADJUSTMENT

### GENERAL INFORMATION

Before tuning up an engine, determine if it is in condition so that performance can be restored by tune-up. Perform the following tests:

### PREDELIVERY ENGINE TESTING

Operation	Specification	Reference
Vacuum test (at air cleaner)	8 to 25 inches of water at fast idle	
Check radiator for air bubbles and indication of oil	.....	.....
Check cylinder compression (minimum)	300 psi	
Test engine power output	Note and compare with output after tune-up	

### ENGINE TUNE-UP

#### AIR INTAKE SYSTEM

Air cleaner - clean filter element and dust cup	.....	Section 30, Group 10
Check breather pipe for restrictions	.....	.....
Retighten cylinder head cap screws	110 ft-lbs torque	Section 20, Group 10
Check valve clearances	0.014 in. intake 0.018 in. exhaust	Section 20, Group 10

#### BATTERY

Check electrolyte level	.....	.....
Clean cables, terminals, and box	.....	.....
Tighten cable clamps	.....	.....

#### ALTERNATOR

Check belt tension	20 pounds at 3/4 in.	.....
Replace brushes	If less than 1/4 in. beyond holder	Section 40, Group 10

#### FUEL SYSTEM

Check fuel tank and lines for leaks or restrictions	.....	.....
Clean fuel transfer pump bowl and strainer (JD570)	.....	.....
Replace fuel filter elements	.....	.....
Drain fuel tank sump	.....	See Operator's Manual
Time injection pump	.....	Section 30, Group 15
Check injection pump advance	.....	Section 30, Group 15
Bleed fuel system	.....	.....
Adjust speed control linkage and check engine speeds	.....	Section 20, Group 20

#### ENGINE LUBRICATION SYSTEM

Check engine oil pressure	40 to 60 psi at 2300 rpm (180° to 220° F.)	Section 20, Group 15
---------------------------	--	----------------------

ENGINE TUNE-UP—Continued

Operation	Specification	Reference
<b>COOLING SYSTEM</b>		
Clean and flush system	.....	.....
Inspect hoses	.....	.....
Clean trash from radiator	.....	.....

ADJUSTMENTS

<b>BRAKES</b>		
Bleed brakes	.....	Section 60, Group 15
Check action of brake accumulator	.....	Section 60, Group 10
Check mechanical parking brake lever effort	.....	Section 60, Group 20
Check service brake with no accumulator pressure	.....	Operator's Manual

POWER STEERING

Bleed steering system		
*Valve leakage (with oil at 140° F., cylinders against stops and 60 in-lbs applied to steering shaft).	2-3 rpm max. 4 rpm indicates excessive leakage	Section 60, Group 5

WHEELS

Check front and rear toe-in	.....	See Section 10, Group 10
Check front wheel bearings	.....	See Operator's Manual

TIRES

Check tire inflation	.....	See Operator's Manual
----------------------	-------	-----------------------

TIGHTEN ACCESSIBLE BOLTS AND CAP SCREWS

See torque chart.		Section 10, Group 25
-------------------	--	----------------------

\*Units with serial numbers 1441, 1447-1450 and 1470-1475



**Suggest:**

**If the above button click is invalid.**

**Please download this document**

**first, and then click the above link**

**to download the complete manual.**

**Thank you so much for reading**

**HYDRAULIC SYSTEM AVERAGE CYCLE TIMES  
 WITH OIL TEMPERATURE BETWEEN 65 AND 145 DEGREES FAHRENHEIT  
 AND ENGINE AT FULL THROTTLE**

Operation	Specifications
Blade pitch, forward . . . . .	1.0-2.0 Seconds
Blade pitch, back . . . . .	1.0-2.0 Seconds
Circle rotation, left (360°) . . . . .	36.0-52.0 Seconds
Circle rotation, right (360°) . . . . .	36.0-52.0 Seconds
Drawbar side shift, left . . . . .	7.4-10.5 Seconds
Drawbar side shift, right . . . . .	5.5-8.5 Seconds
Drift check, blade raised 6 in. movement is 1/16 inch maximum in 15 min.	
Frame steer, right and left. . . . .	3.0-7.0 Seconds
Lift cylinders, right and left, retract 12 inches (Early Units) . . .	4.0-7.5 Seconds
(Early Units) . . .	4.0-6.0 Seconds without orifice
retract 12 inches (Later Units) . . .	3.5-4.5 Seconds with orifice
extend 12 inches. . . . .	2.5-4.5 Seconds
Moldboard side shift, left. . . . .	7.5-10.2 Seconds
Moldboard side shift, right. . . . .	5.5-8.0 Seconds
Scarifier, extend (Early Units) . . . . .	4.0-8.0 Seconds
(Later Units with orifice) . . . . .	2.5-6.0 Seconds
Scarifier, retract (Early Units) . . . . .	6.5-9.7 Seconds
(Later Units with orifice). . . . .	3.5-7.0 Seconds
Wheel lean, left or right. . . . .	2.0-3.7 Seconds

Determine if engine is performing at its rated horsepower (83 hp for JD570, 85 hp for JD570-A).

Compare output of engine with what it delivered prior to tune-up.

**<https://www.ebooklibonline.com>**

Hello dear friend!

Thank you very much for reading.

Enter the link into your browser.

The full manual is available for immediate download.

**<https://www.ebooklibonline.com>**