

**570, 575
and 375
Skid-Steer
Loaders**

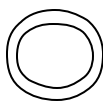
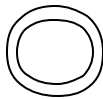
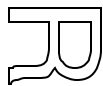
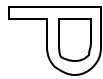
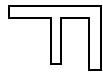
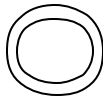

John Deere Horicon Works
TM1359 (20APR90)

LITHO IN U.S.A.
ENGLISH

Contents

SECTION 10—GENERAL INFORMATION

- Group 05—Introduction and Safety
- Group 10—General Specifications
- Group 15—Cap Screw Torque
- Group 20—Tune-Up
- Group 25—Fuel and Lubrication—570
- Group 30—Fuel and Lubrication—575 and 375
- Group 35—Serial Numbers



10

SECTION 20—DIESEL ENGINE

- Group 05—Engine Removal and Installation—Model 575
- Group 06—Engine Removal and Installation Model 375
- Group 10—Cooling System

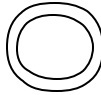

20

SECTION 25—GASOLINE ENGINE

- Group 05—Gasoline Engine Removal and Installation
- Group 10—Valve Actuating Means and Camshaft
- Group 15—Manifold, Cylinder Heads and Valves
- Group 20—Flywheel and Housing
- Group 25—Connecting Rods and Pistons
- Group 30—Crankshaft and Main Bearings
- Group 35—Gear Housing
- Group 40—Lubrication System
- Group 45—Cooling System

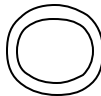

25

SECTION 30—FUEL AND AIR SYSTEM—DIESEL

- Group 05—Throttle Control Linkage
- Group 10—External Fuel Supply

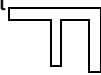

30

SECTION 35—FUEL AND AIR SYSTEM (GASOLINE)

- Group 05—Carburetor
- Group 10—Carburetor and Governor Linkages
- Group 15—External Fuel Supply

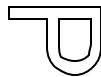

35

SECTION 40—ELECTRICAL

- Group 05—Alternator—Model 570
- Group 10—Starter—Model 570
- Group 15—Seat Lockout Switch



40

Index

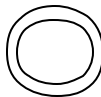

INDX

All information, illustrations and specifications in this manual are based on the latest information available at the time of publication. The right is reserved to make changes at any time without notice.

TM1359-19-20APR90

COPYRIGHT©1989
DEERE & COMPANY
Moline, Illinois
All rights reserved
A John Deere ILLUSTRATION™ Manual

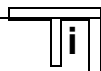

Contents

SECTION 50—POWER TRAIN

- Group 05—Hydrostatic Pumps—Models 570 and 575
- Group 06—Hydrostatic Pump—Model 375
- Group 10—Hydrostatic Motors—Models 570 and 575
- Group 11—Hydrostatic Motors—Model 375
- Group 15—Drive Chains and Axles—Models 570 and 575
- Group 16—Drive Chains and Axles—Model 375
- Group 20—Drive Shaft

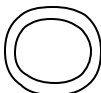

SECTION 60—STEERING AND BRAKES

- Group 05—Park Brake
- Group 10—Steering Neutralizer

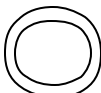

SECTION 70—HYDRAULICS

- Group 05—Hydraulic Pump—Models 570 and 575
- Group 06—Hydraulic Pump—Model 375
- Group 10—Main Control Valve
- Group 15—Hydraulic Cylinders
- Group 20—Miscellaneous Hydraulics
- Group 25—Lift Arms, Linkage and Stops

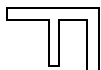

SECTION 210—SPECIFICATIONS/OPERATIONAL CHECKOUT

- Group 01—Test and Adjustment Specifications
- Group 05—Machine Operational Checkout

SECTION 220—ENGINE OPERATION AND TESTS

- Group 05—Engine System Checkout—375/575
- Group 06—Engine System Checkout—570
- Group 10—Engine System Diagnosis—375/575
- Group 11—Engine System Diagnosis—570

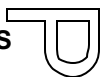

SECTION 240—ELECTRICAL OPERATION AND TESTS

- Group 05—Electrical System Checkout
- Group 10—Electrical System Diagnosis
- Group 15—Component Locations and Diagrams



SECTION 250—POWER TRAIN OPERATION AND TESTS

- Group 05—Power Train System Checkout
- Group 10—Power Train Tests and Adjustments



All information, illustrations and specifications in this manual are based on the latest information available at the time of publication. The right is reserved to make changes at any time without notice.



TM1359-19-20APR90

SECTION 270—HYDRAULIC OPERATION AND TEST

- Group 05—Hydraulic System Checkout
- Group 10—Hydraulic System Tests
- Group 15—Schematic Diagrams

50

60

70

210

220

240

250

270

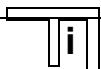

<https://www.ebooklibonline.com>

Hello dear friend!

Thank you very much for reading.

Enter the link into your browser.

The full manual is available for immediate download.

<https://www.ebooklibonline.com>

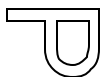

GENERAL INFORMATION

Contents

Page

Group 05—Introduction and Safety

Introduction	10-05-1
Safety	10-05-2

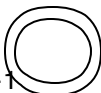

Group 10—General Specifications

570 Skid-Steer Loader	10-10-1
575 Skid-Steer Loader	10-10-3

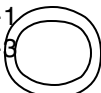

Group 15—Cap Screw Torque

Bolt Torque Chart	10-15-1
Metric Hardware Torque Specifications	10-15-2

Group 20—Tune-Up

570 and 575 Skid-Steer Loader	10-20-1
---	---------

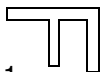

Group 25—Fuel and Lubrication—570

Fuel	10-25-1
Storing and Handling Fuel	10-25-1
Engine Oil	10-25-2
General Purpose Grease	10-25-2
Hydraulic Oil	10-25-3

Group 30—Fuel and Lubrication—575 and 375

Fuel	10-30-1
Fuel Specifications	10-30-1
Fuel Storage	10-30-2
Diesel Engine Oil	10-30-3
General Purpose Grease	10-30-4
Hydraulic Oil	10-30-4

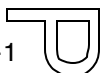

Group 35—Serial Numbers

Product Identification Number	10-35-1
Engine Serial Number	10-35-1

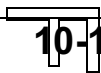
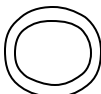
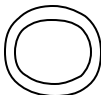

INTRODUCTION

This manual is part of a total service support program.

FOS MANUALS—REFERENCE

TECHNICAL MANUALS—MACHINE SERVICE

COMPONENT MANUALS—COMPONENT SERVICE

Fundamentals of Service (FOS) Manuals cover basic theory of operation, fundamentals of troubleshooting, general maintenance, and basic types of failures and their causes. FOS Manuals are for training new personnel and for reference by experienced technicians.

Technical Manuals are concise service guides for specific machines. Technical manuals are on-the-job guides containing only the vital information needed by an experienced service technician.

Component Technical Manuals are concise service guides for specific components. Component Technical Manuals are written as stand alone manuals covering multiple machine applications.



10-05

TM1359 -JUN 2004 J5.03

O53,INTRO2 -19-03JUL85

FEATURES OF THIS TECHNICAL MANUAL

John Deere ILLUSTRATION format emphasizing illustrations and concise instructions in easy-to-use modules.

Emphasis on diagnosis, analysis, and testing so you can understand the problem and correct it.

Diagnostic information presented with the most logical and easiest to isolate problems first to help you identify the majority of routine failures quickly.

Step-by-step instructions for teardown and assembly.

Summary listing at the beginning of each group of all applicable specifications, wear tolerances, torque values, essential tools, and materials needed to do the job.

An emphasis throughout on safety—so you do the job right without getting hurt.

This technical manual was planned and written for you—an experienced service technician. Keep it in a permanent binder in the shop where it is handy. Refer to it when you need to know correct service procedures or specifications.



TM1359 -JN-23N-J533

O53.INTRO3 -19-07OCT85

SAFETY AND YOU

CAUTION: This safety symbol is used for important safety messages. When you see this symbol, follow the safety message to avoid personal injury.



TJ1309 -JN-07C-2033

M45,1005A,3 -19-09JAN85

PREPARE FOR EMERGENCIES

Be prepared if a fire starts.

Keep a first aid kit and fire extinguisher handy.

Keep emergency numbers for doctors, ambulance service, hospital, and fire department near your telephone.

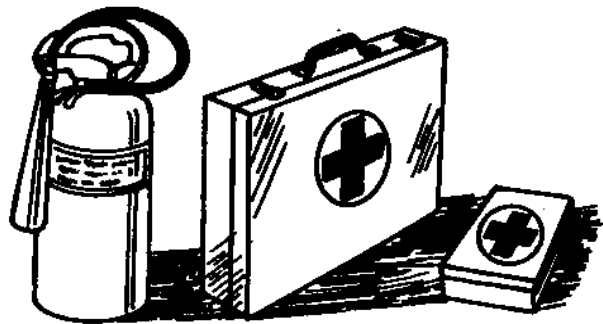
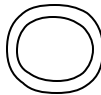

O53,FIRE2 -19-26JAN90

TS291 -JUN-20-1990

HANDLE FUEL SAFELY—AVOID FIRES

Handle fuel with care: it is highly flammable. Do not refuel the machine while smoking or when near open flame or sparks.

Always stop engine before refueling machine. Fill fuel tank outdoors.

Prevent fires by keeping machine clean of accumulated trash, grease, and debris. Always clean up spilled fuel.

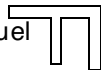
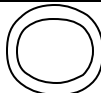

O53,FIRE1 -19-26JAN90

TS202 -JUN-20-1990

LEARN MACHINE SAFETY

Carefully read this manual. Learn how to operate the machine and how to use the controls properly.

Do not let anyone operate this machine without proper instruction.

Unauthorized modifications to the machine may impair the function and/or safety and affect machine life.

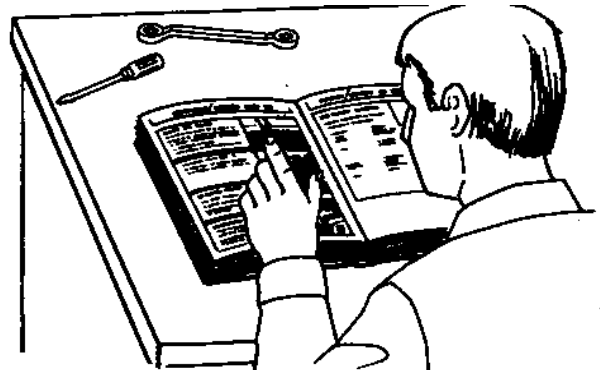
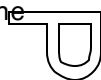

O53,READ2 -19-08JUL85

TS100 -JUN-20-1990

WEAR PROTECTIVE CLOTHING

Wear fairly tight clothing and safety equipment.

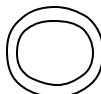
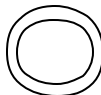

M45,1005A,6 -19-09JAN85

MS-300 -JUN-20-1990

PROTECT AGAINST NOISE

Prolonged exposure to loud noise can cause impairment or loss of hearing.

Wear a suitable hearing protective device such as earmuffs or earplugs to protect against objectionable or uncomfortable loud noises.

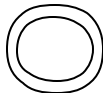

O53,NOISE -19-26JAN90

TS.217 -J14-20A-J5.23

AVOID HIGH-PRESSURE FLUIDS

Escaping fluid under pressure can penetrate the skin causing serious injury.

Avoid the hazard by relieving pressure before disconnecting hydraulic or other lines. Tighten all connections before applying pressure.

Search for leaks with a piece of cardboard. Protect hands and body from high pressure fluids.

If an accident occurs, see a doctor immediately. Any fluid injected into the skin must be surgically removed within a few hours or gangrene may result. Doctors unfamiliar with this type of injury may call the Deere & Company Medical Department in Moline, Illinois, or other knowledgeable medical source.

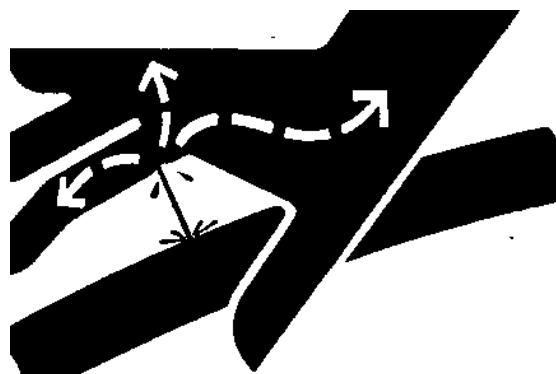
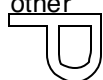
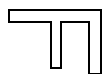
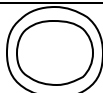

O53,FLUID -19-26JAN90

X8911 -J14-20A-J5.23

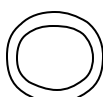
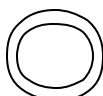

SERVICE LOADER SAFELY

Do not work under lift arms unless they are resting on lift arm stops.



Before you work on loader or any attached equipment:

- Lower attachments to ground, or
- Rest lift arms on lift arm stops.



Lower lift arms all the way and stop engine before you install or remove attachments.

Before you make repairs or adjustments, stop the engine.



Do not change engine governor settings or overspeed engine.

Keep the loader and attachments in good operating condition.



Keep safety devices in place and in working condition.

Keep all nuts, bolts, and screws tight so equipment is in safe working condition.

Before you work on any part of the engine, stop the engine, and let it cool. Hot engine parts can burn skin on contact.

Do not run engine unless park brake is locked.



Be careful to prevent clothing, jewelry, or long hair from getting caught in the fan blades, belts, or any other moving parts.

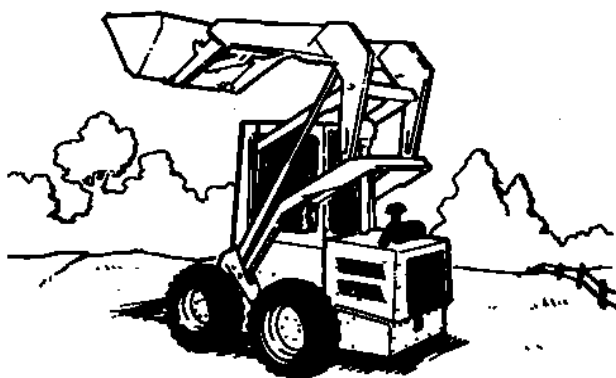

100909 -JN-20-2908

M21,SAU.I -19-09SEP85

PREVENT BATTERY EXPLOSIONS



Battery gas can explode. Keep sparks and flames away from batteries. Use a flashlight to check battery electrolyte level.

Never check battery charge by placing a metal object across the posts. Use a voltmeter or hydrometer.



Always remove grounded (-) battery clamp first and replace it last.

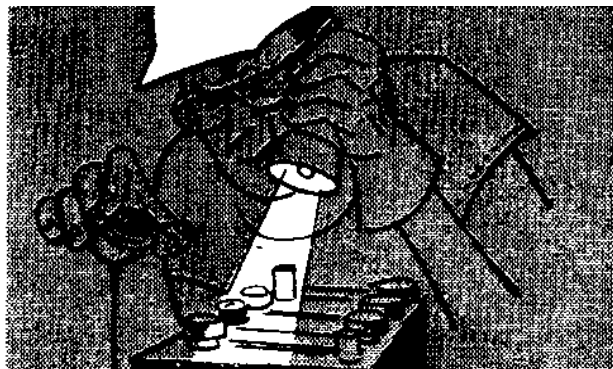

TS131 -JN-20-2503

O53,EXPLO -19-29JAN86

CAUTION: Sulfuric acid in battery electrolyte is poisonous. It is strong enough to burn skin, eat holes in clothing, and cause blindness if splashed into eyes.

Avoid the hazard by:

1. Filling batteries in a well-ventilated area.
2. Wearing eye protection and rubber gloves.
3. Avoiding breathing fumes when electrolyte is added.
4. Avoiding spilling or dripping electrolyte.
5. Use proper jump start procedure.

If you spill acid on yourself:

1. Flush your skin with water.
2. Apply baking soda or lime to help neutralize the acid.
3. Flush your eyes with water for 10—15 minutes. Get medical attention immediately.

If acid is swallowed:

1. Drink large amounts of water or milk.
2. Then drink milk of magnesia, beaten eggs, or vegetable oil.
3. Get medical attention immediately.

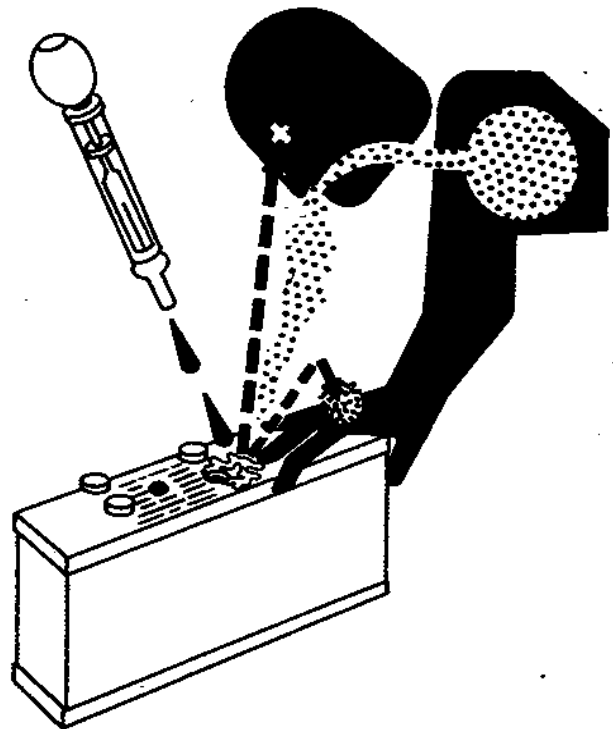

TS2200 -JUN-2014J55d3

O53,ACID -19-29JAN86

SERVICE TIRES SAFELY

Failure to follow proper procedures when mounting a tire on a wheel or rim can produce an explosion which may result in serious injury or death. Do not attempt to mount a tire unless you have the proper equipment and experience to perform the job. Have it done by your John Deere dealer or a qualified tire repair service.

When sealing tire beads on rims, never exceed 35 psi (241 kPa) (2.4 bar) or maximum inflation pressures specified by tire manufacturers for mounting tires.

Inflation beyond this maximum pressure may break the bead, or even the rim, with dangerous explosive force. If both beads are not seated when the maximum recommended pressure is reached, deflate, reposition tire, relubricate bead and reinflate.



1510
-JN-237-J588
O53-TIRE4

O53,TIRE4 -19-21APR86

P
R
O
O

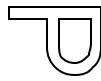

10
10

570 SKID-STEER LOADER

ENGINE

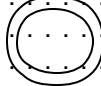
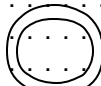
Manufacturer		Teledyne Continental
Model		TM13
Cylinders		2
Bore and stroker 3.58 x 4.06 in. (91 x 103.2 mm)		
Displacement		81.9 in. ³ (1342 cm ³)
Fast idle		2800 rpm
Slow idle		1000 rpm
Horsepower		31 at 2800 rpm
Intake valve clearance (cold)		0.014 in. (0.35 mm)
Exhaust valve clearance (cold)		0.018 in. (0.46 mm)
Spark plug		Champion RN9YC
Spark Plug gap		0.035 in. (0.89 mm)
Spark plug torque		30 lb-ft (41 N·m)
Gradability (maximum angle for engine operation on intermittent basis)		45° all directions

CAPACITIES

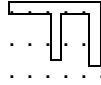
Engine oil with filter		5 qt (4.7 L)
Fuel tank		10 gal (38 L)
Cooling system		6 qt (5.7 L)
Hydraulic system		15 gal (57 L)

ELECTRICAL SYSTEM

Battery		12 V, cold cranking capacity: 445 amps at 0°F (-18°C)
Alternator		37 amp
Circuit breaker		20 amp

HYDROSTATIC TRANSMISSION

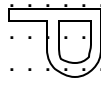
Manufacturer		Cessna
Charge filter		10 micron
Relief pressure		4000 psi (276 bar) (27 580 kPa)
Warning light pressure setting		50 psi (3.5 bar) (350 kPa)

HYDRAULIC SYSTEM

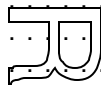
Relief pressure		2000 psi (138 bar) (13 790 kPa)
Pump manufacturer		Cessna
Return filter		10 micron
Suction screen		100 mesh
Pump output		8.2 gpm (31 L/min) at 2800 rpm

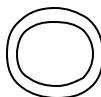

M21,1010U,A -19-10JUN86

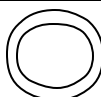

2019

LIFT ARM CYLINDERS

Type		Double-acting
Bore 1-1/2 in. (38 mm)		
Stroke		33 in. (840 mm)
Rod size		1-1/4 in. (32 mm)
Breakout force		1800 lb (816 kg)

BUCKET CYLINDER

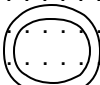
Type		Double-acting
Bore		3 in. (76 mm)
Stroke		9-1/2 in. (240 mm)
Rod size		1-1/2 in. (38 mm)
Breakout force		1950 lb (885 kg)
Raising time with SAE operating load		4 sec
Dumping time with SAE operating load		1.7 sec
Lowering time empty		2.7 sec
Retract time empty		1.8 sec
Maximum reach		29 in. (740 mm)

TIRE SIZES AND PRESSURES

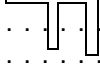
5.70 X 15 (4-ply tubeless)		50 psi (3.5 bar) (350 kPa)
27 x 8.50 x 15 (6-ply tubeless)		40 psi (2.8 bar) (280 kPa)
27 x 10.50 x 15 (6-ply tubeless)		40 psi (2.8 bar) (280 kPa)
Wheel bolt torque		150 lb-ft (200 N·m)



TRAVEL SPEEDS

(Forward and Reverse) 0—7.5 mph (11.2 km/h)

OPERATING WEIGHT

..... 3340 lb (1515 kg)

BUCKET CAPACITIES AND WEIGHTS

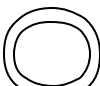
Bucket size in. (M)	Struck Capacity cu. ft. (M ³)		Heaped Capacity cu. ft. (M ³)	Weight lbs. (kg)
*47 (1.19) utility bucket	8.8 (0.25)		11.0 (0.31)	231 (105)
54 (1.37) dirt and foundry bucket	7.5 (0.21)		9.5 (0.27)	256 (116)
54 (1.37) utility bucket	10.2 (0.29)		12.7 (0.34)	254 (115)
60 (1.52) utility bucket	11.3 (0.32)		14.1 (0.40)	272 (123)
60 (1.52) low profile bucket	6.4 (0.18)		8.4 (0.24)	289 (131)
66 (1.68) light materials bucket	12.5 (0.35)		15.6 (0.44)	298 (135)

*Use with 5.70 x 15 tires only.

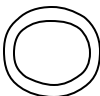

(Specifications and design subject to change without notice.)

M21,1010U,B -19-10OCT86

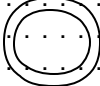

575 SKID-STEER LOADER

ENGINE

Manufacturer		Yanmar
Model		3TNA82RJL Diesel
Cylinders		3
Bore and stroke		3.23 x 3.39 in. (82 x 86 mm)
Displacement		83.1 in. ³ (1362 cm ³)
Fast idle		2950 rpm
Slow idle		950 rpm
Horsepower (mfg. rating)		33 at 3600 rpm (24.6 kW)
Operating horsepower		28.7 at 2800 rpm (21.4 kW)
Intake valve clearance (cold)		0.014 in. (0.35 mm)
Exhaust valve clearance (cold)		0.018 in. (0.46 mm)
Gradability (maximum angle for engine operation on intermittent basis)		45° all directions

CAPACITIES

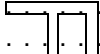
Engine oil with filter		6.4 qt (6 L)
Fuel tank		10 gal (38 L)
Cooling system		6 qt (5.7 L)
Hydraulic system		15 gal (57 L)

ELECTRICAL SYSTEM

Battery		12 V, cold cranking capacity: 445 amps at 0°F (-18°C)
Alternator		37 amp
Circuit breaker		20 amp

HYDROSTATIC TRANSMISSION

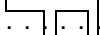
Manufacturer		Cessna
Charge filter		10 micron
Relief pressure		4000 psi (276 bar) (27 580 kPa)
Warning light pressure setting		50 psi (3.5 bar) (350 kPa)

HYDRAULIC SYSTEM

Relief pressure		2000 psi (138 bar) (13 790 kPa)
Pump manufacturer		Cessna
Return filter		10 micron
Suction screen		100 mesh
Pump output		8.2 gpm (31 L/min) at 2800 rpm
Displacement		0.66 cu in. per rev (10.8 cm ³)

SAE RATED LOAD LIMIT

.....		1200 LB (544 KG)
-------	--	------------------

DIMENSIONS—575 Skid-Steer Loader with 54-in. (1372 mm) bucket and 27 x 8.50 x 15 tires

Overall length		116-1/2 in. (2959 mm)
Overall width		54 in. (1372 mm)
Maximum height, bucket raised		126 in. (3200 mm)
Height to top of cab		171-3/4 in. (1822 mm)

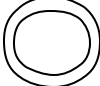



41010

LIFT ARM CYLINDERS

Type		Double-acting
Bore		
Stroke		33 in. (840 mm)
Rod size		1-1/4 in. (32 mm)
Breakout force		1800 lb (816 kg)

BUCKET CYLINDER

Type		Double-acting
Bore		3 in. (76 mm)
Stroke		9-1/2 in. (240 mm)
Rod size		1-1/2 in. (38 mm)
Breakout force		1950 lb (885 kg)
Raising time with SAE operating load		4 sec
Dumping time with SAE operating load		1.7 sec
Lowering time empty		2.7 sec
Retract time empty		1.8 sec
Maximum reach		29 in. (740 mm)

TIRE SIZES AND PRESSURES

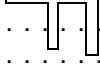
5.70 X 15 (4-ply tubeless)		50 psi (3.5 bar) (350 kPa)
27 x 8.50 x 15 (6-ply tubeless)		40 psi (2.8 bar) (280 kPa)
27 x 10.50 x 15 (6-ply tubeless)		40 psi (2.8 bar) (280 kPa)
Wheel bolt torque		150 lb-ft (200 N·m)



TRAVEL SPEEDS

(Forward and Reverse) 0—7.5 mph (11.2 km/h)

OPERATING WEIGHT

..... 3340 lb (1515 kg)

BUCKET CAPACITIES AND WEIGHTS

Bucket size in. (M)	Struck Capacity cu. ft. (M ³)		Heaped Capacity cu. ft. (M ³)	Weight lbs (kg)
*47 (1.19) utility bucket	8.8 (0.25)		11.0 (0.31)	231 (105)
54 (1.37) dirt and foundry bucket	7.5 (0.21)		9.5 (0.27)	256 (116)
54 (1.37) utility bucket	10.2 (0.29)		12.7 (0.34)	254 (115)
60 (1.52) utility bucket	11.3 (0.32)		14.1 (0.40)	272 (123)
60 (1.52) low profile bucket	6.4 (0.18)		8.4 (0.24)	289 (131)
66 (1.68) light materials bucket	12.5 (0.35)		15.6 (0.44)	298 (135)

*Use with 5.70 x 15 tires only.

(Specifications and design subject to change without notice.)

M21,1010U,D -19-20MAY86

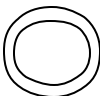

375 SKID-STEER LOADER

ENGINE

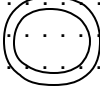
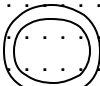
Make and model		Yanmar 3TN66
Cooling system		Water Cooled
Fuel		Diesel
Cylinders		3
Horsepower at governed rpm		17 hp @ 3400 rpm (12.7 kW)
Bore		2.6 in. (66 mm)
Stroke		2.53 in. (64.2 mm)
Displacement		41.8 cu in (.658 L)
RPM speeds:		
Fast (no load)		3600 to 3670 rpm
Slow (no load)		1400 to 1500 rpm
Fuel tank capacity		6 U.S. gal. (22.7 L)
Crankcase capacity		2.5 qt. (2.4 L)
Cooling capacity		4.6 qt. (4.4 L)

ELECTRICAL SYSTEM

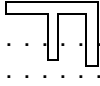
Alternator		20 amp
Battery cold capacity amps at 0°F (-18°C)		390 amps
Battery		BCI-71, 12 V
Regulator		Solid state

TRANSMISSION

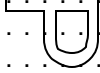
Type		Hydrostatic
Manufacturer		
—Pumps		Sundstrand
—Motors		Nichols 130 Series
Pump type		Axial piston, variable swash plate
Motor type		Geroller motor
Filter		10 micron (no by-pass)
Capacity		9 U.S. gal (34 L)

TRAVEL SPEED

(Forward/Backward) 0 to 5.8 mph (0 to 9.3 km/h)

BOOM CYLINDERS

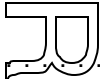
		Double acting
--	---	---------------

HYDRAULIC SYSTEM

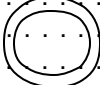
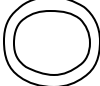
Pump type		Gear
Pump manufacturer		Parker
Output (at governed rpm)		8 gpm (30.2 L/min)
Displacement		13 cm ³ (.512 cu in)
Main system relief pressure		1600 psi (11,032 kPa)
Suction screen		100 mesh
Filter (return side no by-pass)		10 micron
Hydraulic fluid		JD HY-GARD® or equivalent SAE J20A oil

General Specifications 575 Skid-Steer Loader

61210

PERFORMANCE RATING*

Operating load, SAE (per SAE J818)		675 lb (306 kg)
Tipping load, SAE	1365 lb (619 kg)
Breakout force, (bucket) SAE IEMC	1409 lb (619 kg)
Operating weight, SAE	2200 lb (998 kg)

SHIPPING WEIGHT

Without attachments		1750 lb (794 kg)
---------------------	---	------------------

CYCLE TIMES (SECONDS)

Boom raised	5.5 seconds
Boom lowered	3.4 seconds
Bucket rollback	1.9 seconds
Bucket dumping		0.9 seconds

TIRE PRESSURE

5.70x12	50 psi (345 kPa)
23x8.50-12	35 psi (240 kPa)

*Performance ratings taken with:

- Full fuel tank, 175 lb operator
- 42-in. (106.7 cm) utility bucket
- 8.50x12-in. tires

(Specifications and design subject to change without notice.)

M21,1010U,F -19-10OCT86

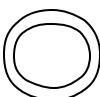
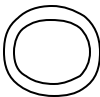
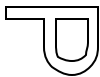



BOLT TORQUE CHART

Grade of Bolt		SAE-2	SAE-5	SAE-8	Socket or Wrench Size	
Min. Tensile Strength		64,000 PSI	105,000 PSI	150,000 PSI		
Grade Marking on Bolt					U.S. Regular	
U.S. Standard					U.S. Regular	
Bolt Dia.	U.S. Dec. Equiv.	TORQUE IN FOOT POUNDS			Bolt Head	Nut
1/4	0.250	(8.14 N-m) 6	(13.56 N-m) 10	(18.98 N-m) 14	7/16	7/16
5/16	0.3125	(17.63 N-m) 13	(27.12 N-m) 20	(40.68 N-m) 30	1/2	1/2
3/8	0.375	(31.19 N-m) 23	(47.46 N-m) 35	(67.80 N-m) 50	9/16	9/16
7/16	0.4375	(47.46 N-m) 35	(74.58 N-m) 55	(108.48 N-m) 80	5/8	11/16
1/2	0.500	(74.58 N-m) 55	(115.26 N-m) 85	(162.72 N-m) 120	3/4	3/4
9/16	0.5625	(101.70 N-m) 75	(176.28 N-m) 130	(237.30 N-m) 175	13/16	7/8
5/8	0.625	(142.38 N-m) 105	(230.52 N-m) 170	(325.44 N-m) 240	15/16	15/16
3/4	0.750	(250.86 N-m) 185	(406.80 N-m) 300	(576.30 N-m) 425	1-1/8	1-1/8
7/8	0.875	(216.96 N-m) 160	(616.98 N-m) 445	(928.86 N-m) 685	1-5/16	1-5/16
1	1.000	(339.00 N-m) 250	(908.52 N-m) 670	(1396.68 N-m) 1030	1-1/2	1-1/2

Multiply readings by 12 for inch-pound values.

* "B" Grade bolts larger than 3/4-inch (19.1 mm) are sometimes formed hot rather than cold, which accounts for the lower recommended torque.

NOTE: Allow a tolerance of plus or minus 10 per cent on all torques given in this chart.

SET SCREW SEATING TORQUE CHART

Screw Size	Cup Point	Square Head
	Torque in Inch Pounds	
#5	(1.02 N-m) 9	—
#6	(1.02 N-m) 9	—
#8	(2.25 N-m) 20	—
#10	(3.78 N-m) 33	—
1/4	(9.83 N-m) 87	(23.96 N-m) 212
5/16	(18.65 N-m) 165	(47.46 N-m) 420
3/8	(32.77 N-m) 290	(93.79 N-m) 830
7/16	(48.59 N-m) 430	—
1/2	(70.06 N-m) 620	(237.30 N-m) 2100
9/16	(70.06 N-m) 620	—
5/8	(138.43 N-m) 1225	(480.25 N-m) 4250
3/4	(240.13 N-m) 2125	(870.10 N-m) 7700

Divide readings by 12 for foot-pound values

NOTE: Allow a tolerance of plus or minus 10 per cent on all torques given in this chart.

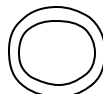
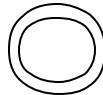

1423373 -19-230-2908

M21,1010K,C -19-25AUG82

12515

METRIC HARDWARE TORQUE SPECIFICATIONS

Metric Standard Thread

Thread	8.8		10.9		1	2.9	
	N·m	(lb-ft)	N·m	(lb-ft)	N·m	(lb-ft)	
M5	5.9	(4.4)	7.9	(5.8)	9.8	(7.2)	
M6	9.8	(7.2)	13.8	(10.2)	16.7	(12.3)	
M8	24.6	(18.1)	34.4	(25.4)	40.2	(29.6)	
M10	48.1	(35.5)	67.8	(50.0)	81.5	(60.1)	
M12	84.4	(62.2)	118.0	(87.0)	142.0	(105.0)	
M14	133.0	(98.0)	187.0	(138.0)	226.0	(187.0)	
M16	206.0	(152.0)	290.0	(214.0)	348.0	(257.0)	
M18	285.0	(210.0)	398.0	(294.0)	476.0	(351.0)	
M20	402.0	(296.0)	570.0	(420.0)	677.0	(499.0)	
M22	540.0	(398.0)	765.0	(564.0)	914.0	(674.0)	
M24	697.0	(514.0)	980.0	(723.0)	1180.0	(870.0)	

Metric Fine Thread

Thread	8.8		10.9		12.9	
	N·m	(lb-ft)	N·m	(lb-ft)	N·m	(lb-ft)
M8 x 1	26.5	(19.5)	37.3	(27.5)	44.2	(32.6)
M10 x 1	47.1	(34.7)	68.8	(50.7)	81.5	(60.1)
M12 x 1.5	88.4	(65.2)	123.0	(91.0)	147.0	(106.0)
M14 x 1.5	147.0	(108.0)	206.0	(152.0)	246.0	(181.0)
M16 x 1.5	221.0	(163.0)	309.0	(228.0)	373.0	(275.0)
M18 x 1.5	319.0	(235.0)	451.0	(333.0)	540.0	(398.0)
M20 x 1.5	451.0	(333.0)	628.0	(463.0)	755.0	(557.0)
M22 x 1.5	599.0	(442.0)	845.0	(623.0)	1030.0	(760.0)
M24 x 2	765.0	(564.0)	1080.0	(796.0)	1275.0	(940.0)
M26 x 2	1130.0	(833.0)	1570.0	(1158.0)	1915.0	(1412.0)

O53.TORQUE -19-13MAR85

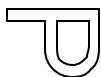

TUNE-UP SPECIFICATIONS

570 SKID-STEER LOADER



Fast idle	2800 rpm
Slow idle	1000 rpm
Horsepower	31 at 2800 rpm
Intake valve clearance (cold)	0.35 mm (0.014 in.)
Exhaust valve clearance (cold)	0.46 mm (0.018 in.)
Spark plug	Champion RN9YC
Spark plug gap	0.89 mm (0.035 in.)
Spark plug torque	41 N·m (30 lb-ft)
Gradability (maximum angle for engine operation on intermittent basis)	45° all directions

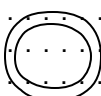

CAPACITIES

Engine oil with filter	4.7 L (5 qt)
Fuel tank	38 L (10 gal)
Cooling system	5.7 L (6 qt)
Hydraulic system	57 L (15 gal)

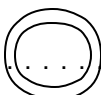

575 SKID-STEER LOADER

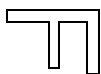

Fast idle	2950 rpm
Slow idle	950 rpm
Horsepower (mfg. rating)	33 at 3600 rpm (24.6 kW)
Operating horsepower	28.7 at 2800 rpm (21.4 kW)
Intake valve clearance (cold)	0.2 mm (0.008 in.)
Exhaust valve clearance (cold)	0.2 mm (0.008 in.)
Gradability (maximum angle for engine operation on intermittent basis)	45° all directions

CAPACITIES

Engine oil with filter	6 L (6.4 qt)
Fuel tank	38 L (10 gal)
Cooling system	5.7 L (6 qt)
Hydraulic system	57 L (15 gal)

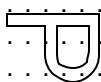

375 SKID-STEER LOADER



Fast idle	3600/3670 rpm
Slow idle	1400/1500 rpm
Horsepower	17 at 3400 rpm (12.7 kW)
Intake valve clearance (cold)	0.2 mm (0.008 in.)
Exhaust valve clearance (cold)	0.2 mm (0.008 in.)
Gradability (maximum angle for engine operation on intermittent basis)	45° all directions

CAPACITIES

Engine oil with filter	3 L (3.1 qt)
Fuel tank	22.7 L (6 gal)
Cooling system	4.4 L (4.6 qt)
Hydraulic system	34 L (9 gal)

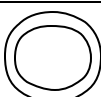
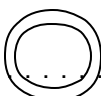

M21,1020U,A -19-27OCT86

FUEL

CAUTION: Handle fuel carefully. If the engine is running, do not fill the fuel tank. If engine is hot, let engine cool several minutes before you add fuel. Do not smoke while you fill the fuel tank or service the fuel system. Fill fuel tank only to bottom of filler neck.

Fuel tank cap is vented, Use only a vented cap.



M21, FLU, A -19-30SEP85

Check Fuel Gauge Regularly

Use regular or unleaded gasoline. Do not alternate. Use one type. Regular gasoline should have minimum octane rating of 85. Gasohol is not recommended.

Fuel tank capacity is 10 gal (38 L).

Fill fuel tank at end of each day's operation.



M21, FLU, B -19-10SEP85

STORING AND HANDLING FUEL

Buy clean, high quality fuel from an honest supplier.

IMPORTANT: Keep dirt, scale, water or other foreign material out of fuel.

Keep fuel in a clean container in a protected area away from buildings.

Drain water and sediment from storage tank regularly.

Keep storage tank on its side with plug up.

Avoid storing fuel for a long time. If you keep fuel for a long time, add a fuel conditioner to prevent water condensation and varnish. See your John Deere dealer for conditioner.

M21, FLA, B -19-10APR85

ENGINE OIL

Use oil viscosity, as shown on the temperature chart for the expected air temperature range during the drain interval.

John Deere TORQ-GARD SUPREME® engine oil is recommended. If other oils are used, they must be premium quality engine oils meeting performance requirements of:

—API Service Classification SD, SE, SE/CC or SF.

Quality engine oils are blended, so additives are neither required nor recommended.

Some increase in oil consumption may be expected when SAE 5W-20 oil is used. Check oil level frequently.

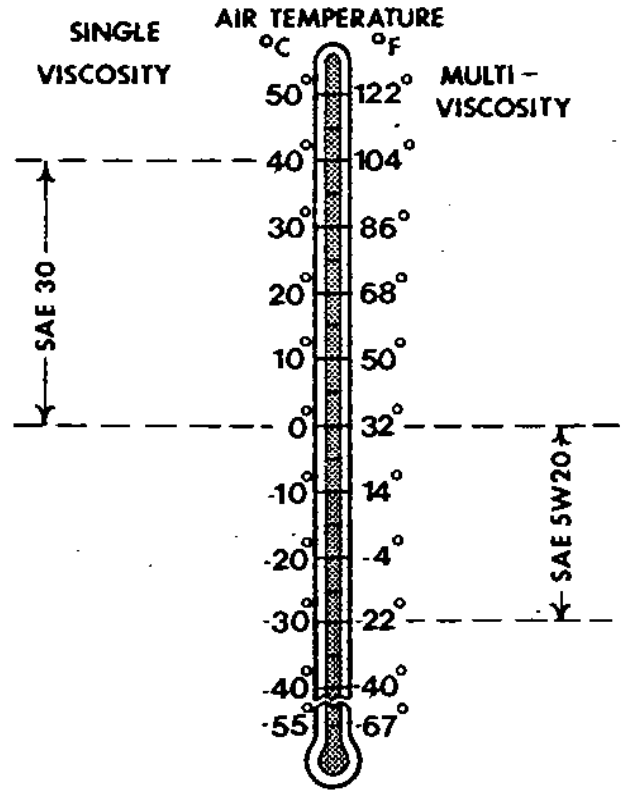

M21,FLJ,02 -19-22APR83

GENERAL PURPOSE GREASE

Use grease as shown on the temperature chart for the expected air temperature range during the service interval.

John Deere Multipurpose Grease is recommended. If other greases are used, use:

- SAE Multipurpose Grease.
- Multipurpose Grease containing 3 to 5 percent molybdenum disulfide.

At temperatures below -22°F (-30°C), use arctic greases such as those meeting Military Specification MIL-G-10924C.

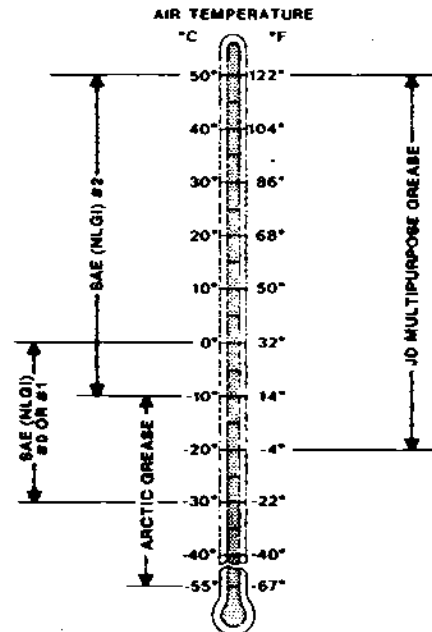

M21,FLJ,05 -19-12MAY83

HYDRAULIC OIL

Use John Deere HY-GARD® Transmission and Hydraulic Oil or an equivalent or oil meeting John Deere J20A specifications.

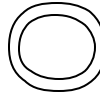
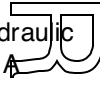

M21,FLU,C -19-10SEP85

COLD WEATHER OPERATION

Additional information on cold weather operation is available from your John Deere dealer.

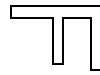
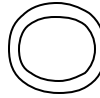

M21,FLA,E -19-23NOV83

ALTERNATIVE LUBRICANTS

Conditions in certain geographical areas outside the United States and Canada may require different lubricant recommendations than those printed in the operator's manual. Consult your John Deere dealer to obtain alternative lubricant recommendations.

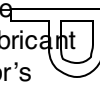

M21,FLA,F -19-23NOV83

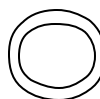
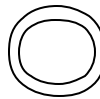

FUEL

CAUTION: Handle fuel carefully. If the engine is running, do not fill the fuel tank. If engine is hot, let engine cool several minutes before you add fuel. Do no smoke while you fill the fuel tank or service the fuel system. Fill fuel tank only to bottom of filler neck.

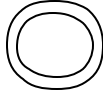

Fuel tank cap is vented. Use only a vented cap.



M21_FLW,A -19-11DEC85

10
30
-JN-085-203
M09009

Check fuel gauge regularly.

Fuel tank capacity is 10 gal (38 L).

Fill fuel tank at end of each day's operation.

If engine runs out of fuel:

- Fill full tank.
- Bleed fuel system. (See Bleeding Fuel System in Service/as Necessary section.)

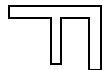
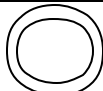

M21_FLW,B -19-11DEC85

-JN-290J533
M00905

FUEL SPECIFICATIONS

Use ONLY clean, high-quality fuel.

Use Grade No. 2-D fuel at temperatures above 40°F (4°C).

Use Grade No. 1-D fuel at temperatures below 40°F (4°C).

Use Grade No. 1-D fuel for all air temperatures at altitudes above 5000 ft (1500 m).

IMPORTANT: Use fuel with less than 1.0 percent sulfur. If possible, use fuel with less than 0.5 percent sulfur.

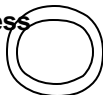
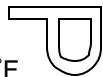

If fuel sulfur is more than 0.5 percent, change engine oil and filter every 100 hours.

For maximum filter life, sediment and water should not be more than 0.10 percent.

The cetane number should be 40 minimum. If you operate your machine where air temperatures are normally low or where altitudes are high, you may need fuel with a higher cetane number.

Cloud Point—For cold weather operation, cloud point should be 10°F (6°C) below lowest normal air temperature.

M21_FLQ,A -19-12MAR85

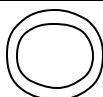



FUEL STORAGE

NOTE: Diesel fuels stored for a long time may form gum and plug filters.



If possible, install a water separator at the storage tank outlet. (See you John Deere dealer for this part.)

Keep fuel in a clean container in a protected area. Water and sediment must be removed before fuel gets to the engine. Do not use de-icers to remove water from fuel. Do not depend on fuel filters to remove water.

IMPORTANT: Keep all dirt, scale, water or other foreign material out of fuel.



Store fuel drum on its side with plug up.

M21,FLQU,B -19-02APR85

DO NOT USE GALVANIZED CONTAINERS



IMPORTANT: Diesel fuel stored in galvanized containers reacts with zinc coating on the container to form zinc flakes. If fuel contains water, a zinc gel will also form. The gel and flakes will quickly plug fuel filters and damage fuel injectors and fuel pumps.

Store fuel in:

- plastic containers.
- aluminum containers.
- specially coated steel containers made for diesel fuel.



DO NOT USE brass-coated containers: brass is an alloy of copper and zinc.

DO NOT USE a galvanized container to store diesel fuel.



M21,FLQ,B1 -19-02AUG85



ENGINE OIL

Depending upon the expected air temperature range during the drain interval, use oil viscosity shown on the adjoining temperature chart.

John Deere TORQ-GARD SUPREME® engine oil is recommended. If other oils are used, they must be premium quality engine oils meeting performance requirements of:

- API Service Classification CD/SC
- Military Specification MIL-L-2104C or MIL-L-2104D

Quality engine oils are blended, so additives are neither required nor recommended.

For SAE 5W20, SAE 10W20, and arctic oil viscosity grades, where oils meeting the above requirements may not be available, oils meeting a minimum of API Service classification CC/SC or Military Specification MIL-L-46152 may be used, but at a short drain interval.

At temperatures below -30°C (-22°F), use arctic oils meeting a minimum of API Service Classification CC/SC or Military Specification MIL-L-46167, but at a shorter drain interval.

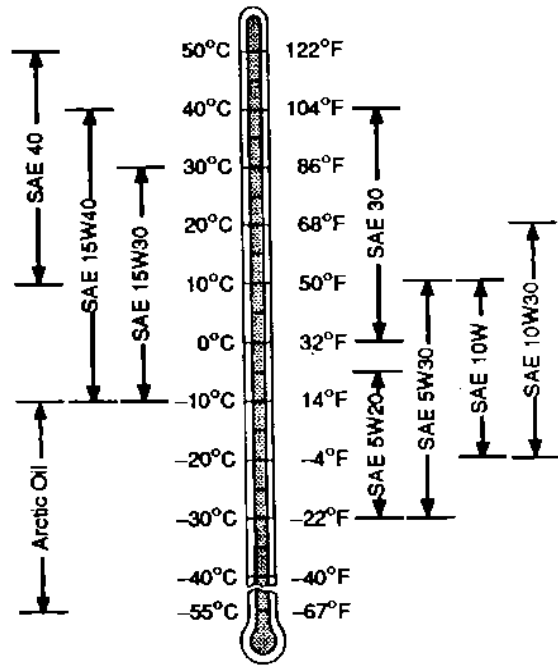

O53, ENGOIL -19-11MAY84

10
30
4

GENERAL PURPOSE GREASE

Use grease as shown on the temperature chart for the expected air temperature range during the service interval.

John Deere Multipurpose Grease is recommended. If other greases are used, use:

- SAE Multipurpose Grease.
- Multipurpose Grease containing 3 to 5 percent molybdenum disulfide.

At temperatures below -22°F (-30°C), use arctic greases such as those meeting Military Specification MIL-G-10924C.

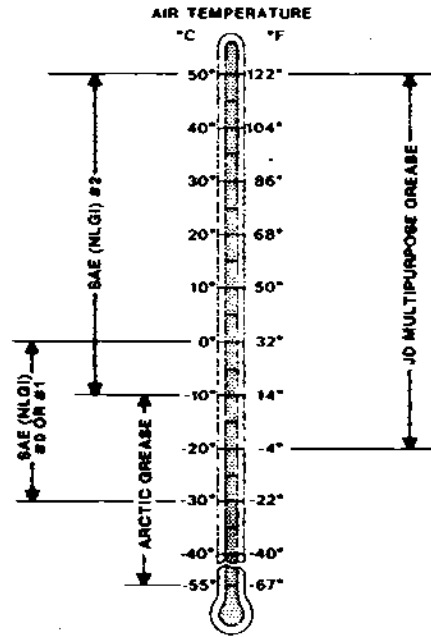

X812A3 -19-00157-00

M21,FLJ,05 -19-12MAY83

HYDRAULIC OIL

Use John Deere HY-GARD® Transmission and Hydraulic Oil or an equivalent or oil meeting John Deere J20A specifications.

M21,FLU,C -19-10SEP85

COLD WEATHER OPERATION

Additional information on cold weather operation is available from your John Deere dealer.

M45,FLA,E -19-23NOV83

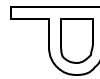

SERIAL NUMBERS

When working on machines or components that are covered by warranty, it is **IMPORTANT** that you include the tractor Product Identification Number and the component serial number on the warranty claim form.



the location of component serial number plates are shown below.

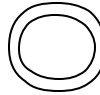

M21,1030R,1 -19-22APR85

PRODUCT IDENTIFICATION NUMBER

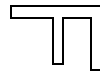
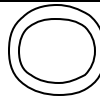

M09012 -19-29MAY83

M21,1035U,A -19-21MAY86

ENGINE SERIAL NUMBER

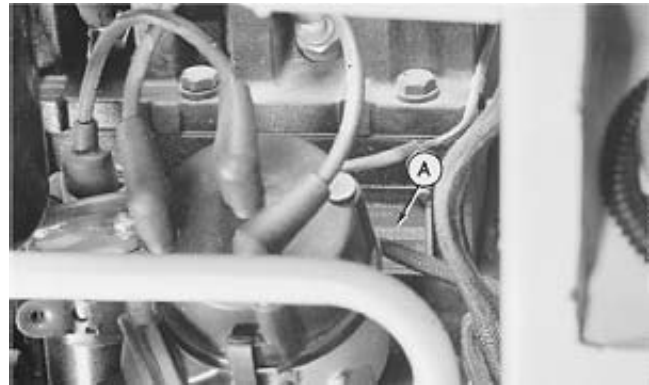
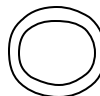
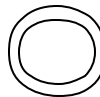
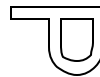

M09010 -19-21MAY80

570



M09014 -19-08JUN86

575 AND 375

M21,1035U,B -19-13JUN86

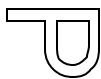

Section 20 DIESEL ENGINE



Contents

Page

Group 05—Engine Removal and Installation—Model 575

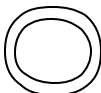

Service Equipment and Tools	20-05-1
Specifications	20-05-1
Remove	
Engine	20-05-2
Engine Mounts	20-05-7
Install	
Engine Mounts	20-05-8
Engine	20-05-8

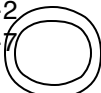

Group 06—Engine Removal and Installation Model 375

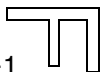

Service Equipment and Tools	20-06-1
Specifications	20-06-1
Engine	
Remove	20-06-2
Install	20-06-5
Bleed Fuel System	20-06-9

Group 10—Cooling System

Radiator—Model 575	
Remove	20-10-1
Install	20-10-2
Radiator—Model 375	
Remove, Inspect and Install	20-10-3

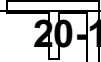
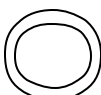
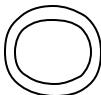
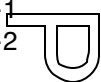

20

SERVICE EQUIPMENT AND TOOLS

NOTE: Order tools from the U.S. SERVICEGARD™ Catalog or from the European Microfiche Tool Catalog (MTC). Some tools may be available from a local supplier.

Name	Use
Load-Positioning Sling	To remove and install engine

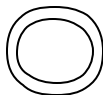

M21,2005U,A -19-30MAY86

SPECIFICATIONS

Item	Measurement	Specification
Engine Mounting Angle Cap Screws	Torque	43 N·m (32 lb-ft)
Engine Mounting Pad Cap Screws	Torque	89 N·m (66 lb-ft)
Hydrostatic Pump Mounting Cap Screws	Torque	37—42 N·m 27—31 (lb-ft)
Engine Mount Bracket-to-Frame Cap Screws	Torque	9 N·m (66 lb-ft)

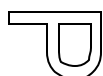
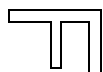
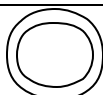

M21,2005U,B -19-30MAY86

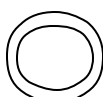
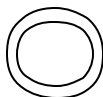

20
05
1

REMOVE ENGINE

CAUTION: Skid steer is very unbalanced if bucket or attachment is on lift arms. Remove bucket or attachment before removing engine.

1. Remove bucket or any lift arm attachment.
2. Park skid steer safely. Put lift arms on lift arm stops. Open engine shield.
3. Remove radiator. (See Remove Radiator in Section 20, Group 10.)
4. Remove battery.

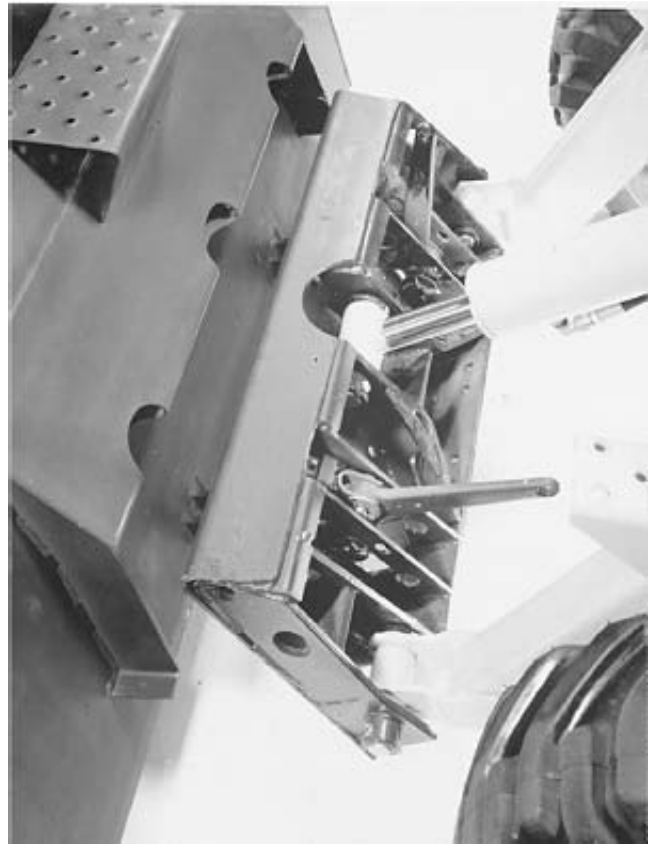

M21,2005U,C -19-09APR86

5. Remove three lower cap screws on engine shield.



M21,2005U,D -19-09APR86

CAUTION: Engine shield is heavy. Handle this weight safely.

6. Open engine shield. Remove three cap screws on each side of engine shield. Remove engine shield.



M21,2005U,E -19-09APR86

7. Remove engine belly pan.



M21,2005U,F -19-09APR86

8. Disconnect air cleaner hose.

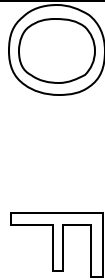

M21,2005U,G -19-09APR86

9. Remove cap screw. Remove cap screw, nut, and fuse holder (A).



M21,2005U,H -19-09APR86

10. Remove two cap screws, nuts, and wiring harness straps (A). Remove air cleaner assembly (B).

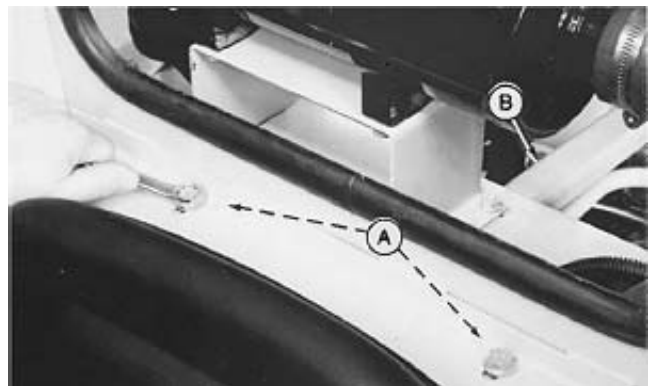

M21,2005U,I -19-09APR86

11. Disconnect air heater wires (A and B). Remove four cap screws and remove air heaters.



M21,2005U,J -19-09APR86

TM1359 (20APR90)

12. Disconnect wires (A, B and C) from sender, alternator, and starter.

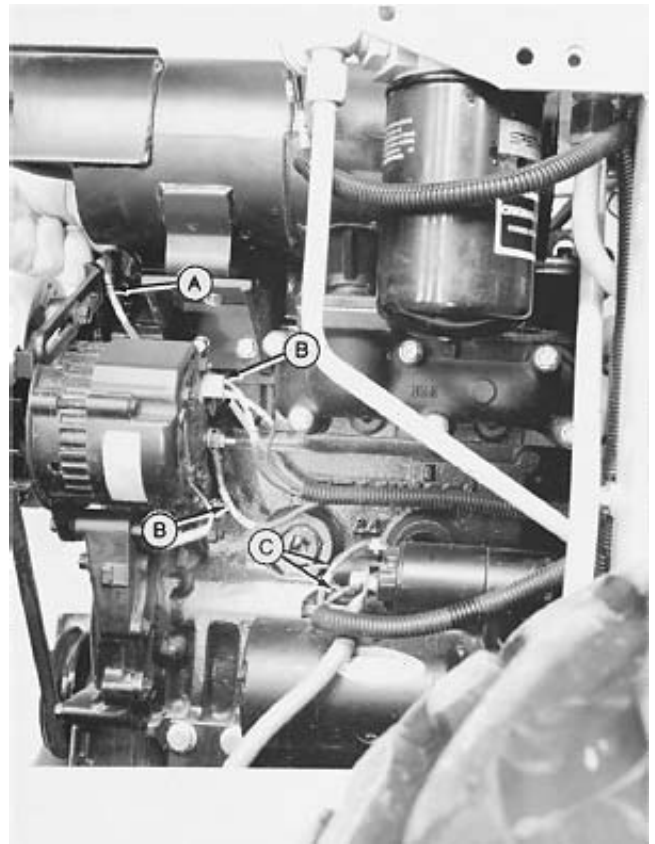

M21,2005U,K -19-30MAY86

TM1359 (20APR90)

13. Disconnect ground strap and negative battery cable from cap screw (A).



M21,2005U,L -19-09APR86

TM1359 (20APR90)

20054

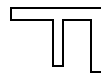
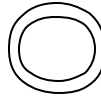
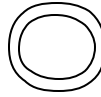
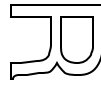

14. Remove two cap screws and four nuts (A). Remove muffler assembly and gasket (B).

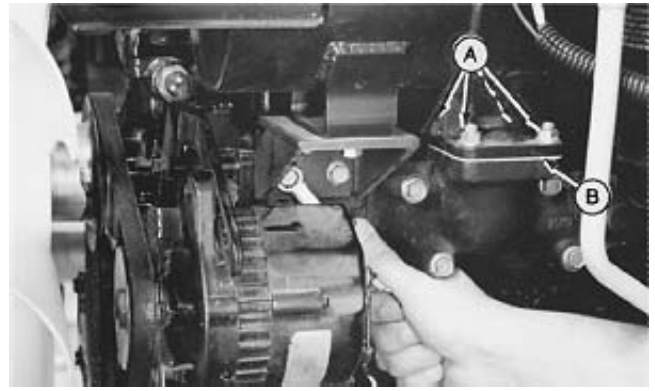
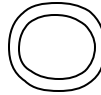
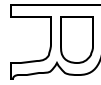

M21,2005U,M -19-09APR86

15. Disconnect fuel lines (A and B). Remove fuel line (B) from behind injector lines and strap on dipstick tube.

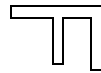
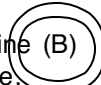

M21,2005U,N -19-09APR86

16. Disconnect wires form electric fuel shut-off harness (A).

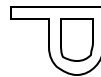

M21,2005U,O -19-09APR86

17. Disconnect throttle linkage (A).

18. Disconnect wire (B) from sender.

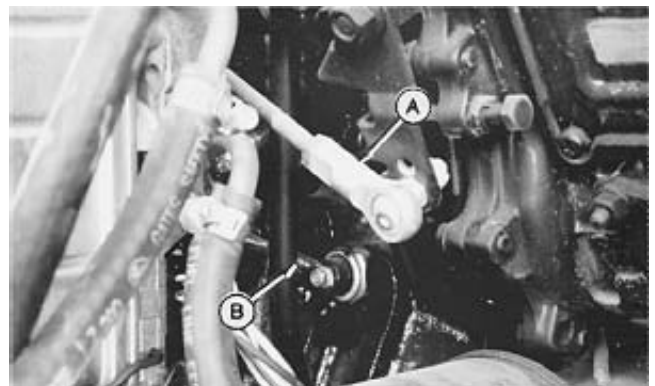
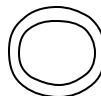
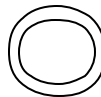

M21,2005U,P -19-09APR86



Suggest:

If the above button click is invalid.

Please download this document

first, and then click the above link

to download the complete manual.

Thank you so much for reading

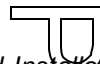

19. Remove wiring harness strap from engine. Install a lifting strap (A) in its place.

20. Remove oil fill tube (B).

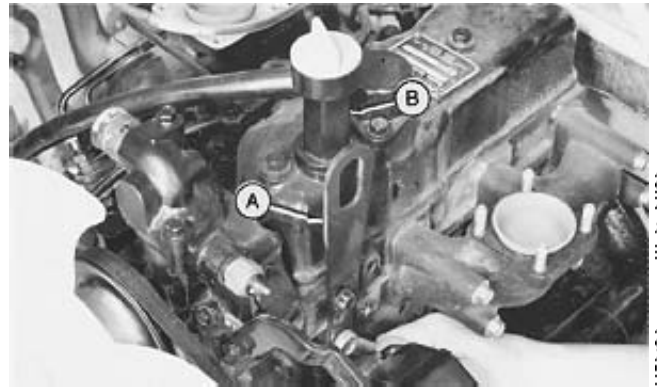
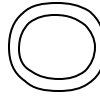
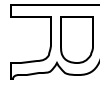

M21,2005U,Q -19-09APR86

TM1359 (20APR90)

20-05-6

21. Support hydrostatic pumps with a lifting strap. Remove cap screws (A).

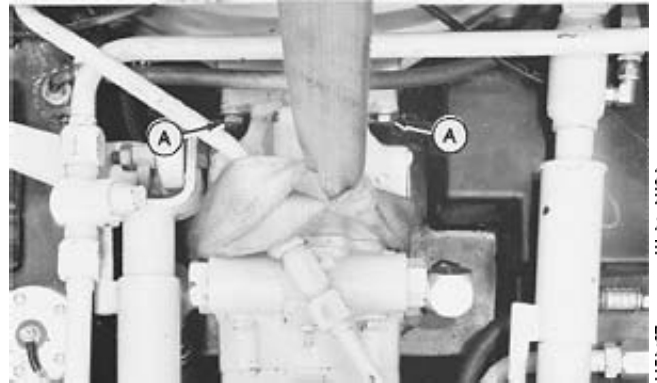
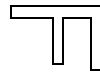
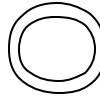

M21,2005U,R -19-09APR86

TM1359 (20APR90)

22. Remove cap screws and nuts from both engine mount brackets.

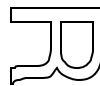
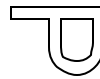

M21,2005U,S -19-09APR86

TM1359 (20APR90)

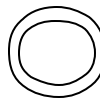
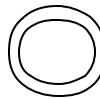

<https://www.ebooklibonline.com>

Hello dear friend!

Thank you very much for reading.

Enter the link into your browser.

The full manual is available for immediate download.

<https://www.ebooklibonline.com>