

John Deere JD555 Crawler Loader

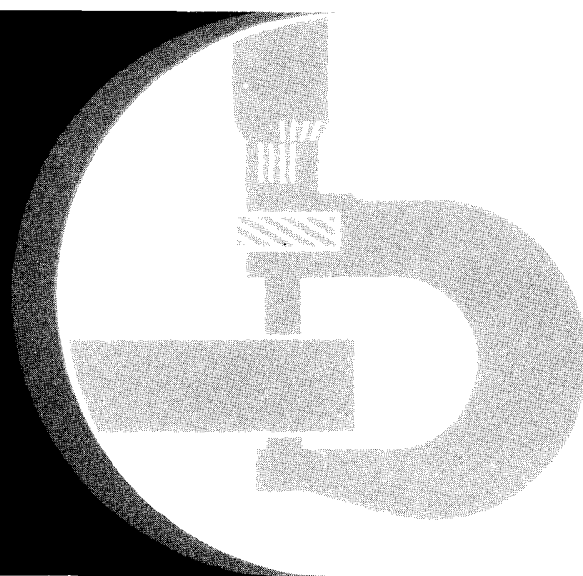

TECHNICAL MANUAL

John Deere Dubuque Works
TM-1111



Litho in U.S.A.

SECTION AND GROUP CONTENTS OF THIS MANUAL

SECTION 1 - GENERAL INFORMATION

- Group I - Contents
- Group II - Introduction and Safety Information
- Group III - General Specifications
- Group IV - Predelivery, Delivery and After-Sale Services
- Group V - Lubrication

SECTION 1 - TRACKS

- Group 0130 - Track Systems
- Group 0199 - Specifications and Special Tools

SECTION 2 - AXLES AND SUSPENSION SYSTEMS

- Group 0201 - Drive Axle Housing and Support
- Group 0210 - Differential or Bevel Drive
- Group 0225 - Input Drive Shafts
- Group 0250 - Axle Shaft, Bearings and Reduction Gears
- Group 0299 - Specifications and Special Tools

SECTION 3 - TRANSMISSION

- Group 0315 - Controls
- Group 0325 - Input Drive Shafts
- Group 0431 - Housings and Covers
- Group 0350 - Gears, Shafts, Bearings and Power Shift Clutch
- Group 0360 - Transmission Hydraulics
- Group 0399 - Specifications and Special Tools

SECTION 4 - ENGINES

- Group 0401 - Crankshaft and Main Bearings
- Group 0402 - Camshafts and Valve Actuating Means
- Group 0403 - Connecting Rods and Pistons
- Group 0404 - Cylinder Block (Liners)
- Group 0407 - Engine Oiling System
- Group 0408 - Ventilating System
- Group 0409 - Cylinder Head and Valves
- Group 0410 - Exhaust Manifold
- Group 0413 - Fuel Injection System
- Group 0415 - Engine Balancer
- Group 0416 - Turbocharger
- Group 0417 - Water Pump
- Group 0418 - Thermostats, Housings and Piping
- Group 0419 - Engine Oil Cooler
- Group 0420 - Fuel Filter
- Group 0421 - Fuel Transfer Pump
- Group 0422 - Starting System
- Group 0433 - Flywheel, Housing and Fasteners
- Group 0499 - Specifications and Special Tools

SECTION 5 - ENGINE AUXILIARY SYSTEMS

- Group 0505 - Cold Weather Starting Aids
- Group 0510 - Engine Cooling Systems
- Group 0520 - Intake System
- Group 0560 - External Fuel Supply Systems
- Group 0599 - Specifications and Special Tools

SECTION 6 - TORQUE CONVERTER

- Group 0615 - Controls and Linkage
- Group 0641 - Converter Housing and Cover
- Group 0651 - Converter Turbine, Gears, Shafts, Etc.
- Group 0660 - Converter Hydraulics
- Group 0699 - Specifications and Special Tools

SECTION 9 - STEERING SYSTEMS

- Group 0960 - Power Steering
- Group 0999 - Specifications and Special Tools

SECTION 15 - EQUIPMENT ATTACHING

- Group 1511 - Drawbar
- Group 1599 - Specifications and Special Tools

SECTION 16 - ELECTRICAL SYSTEMS

- Group 1671 - Batteries, Support and Cables
- Group 1672 - Alternator, Regulator and Charging System Wiring
- Group 1673 - Vehicle Lighting System
- Group 1674 - Wiring Harness and Switches
- Group 1699 - Specifications and Special Tools

SECTION 17 - CRAWLER MAIN FRAME

- Group 1741 - Crawler Main Frame
- Group 1746 - Frame Bottom Guard
- Group 1749 - Chassis Weights
- Group 1799 - Specifications and Special Tools

SECTION 18 - OPERATOR'S STATION

- Group 1808 - Comfort and Convenience Items
- Group 1810 - Operator Enclosure
- Group 1821 - Seat
- Group 1823 - Instruments and Indicators
- Group 1824 - External Engine Speed Controls
- Group 1899 - Specifications and Special Tools

SECTION 19 - SHEET METAL

- Group 1910 - Hood or Engine Enclosure
- Group 1921 - Grille and Grille Housing

SECTION 21 - MAIN HYDRAULIC SYSTEM

- Group 2160 - Hydraulic System
- Group 2199 - Specifications and Special Tools

SECTION 30 - WINCH

- Group 3015 - Controls Linkage
- Group 3041 - Winch Housing and Mounting Structure
- Group 3050 - Winch Drive and Clutches
- Group 3060 - Winch Hydraulic System
- Group 3099 - Specifications and Special Tools

SECTION 31 - LOADER

- Group 3102 - Buckets
- Group 3103 - Forks
- Group 3115 - Controls Linkage
- Group 3140 - Loader Frames
- Group 3160 - Loader Hydraulics
- Group 3199 - Specifications and Special Tools

SECTION 33 - BACKHOE

- Group 3302 - Bucket
- Group 3315 - Controls Linkage
- Group 3340 - Frames
- Group 3360 - Hydraulic System
- Group 3399 - Specifications and Special Tools

SECTION 37 - LOG ARCH

- Group 3740 - Frames

SECTION 40 - WINCH DRIVE

- Group 4051 - Gears, Shafts and Bearings
- Group 4099 - Specifications and Special Tools

SECTION 42 - GROUND CONDITIONING TOOL

- Group 4201 - Teeth and Shanks
- Group 4240 - Frame
- Group 4260 - Hydraulic System
- Group 4299 - Specifications and Special Tools

SECTION 90 - SYSTEM TESTING

- Group 9005 - General Information - Seven Basic Steps of Testing and Diagnosis
- Group 9010 - Engine
- Group 9015 - Electrical System
- Group 9020 - Power Train
- Group 9025 - Hydraulic System
- Group 9025A - Hydraulic System (Analyzer)
- Group 9030 - Miscellaneous Components
- Group 9035 - Specifications and Special Tools

II INDEX

Group II INTRODUCTION AND SAFETY INFORMATION INTRODUCTION

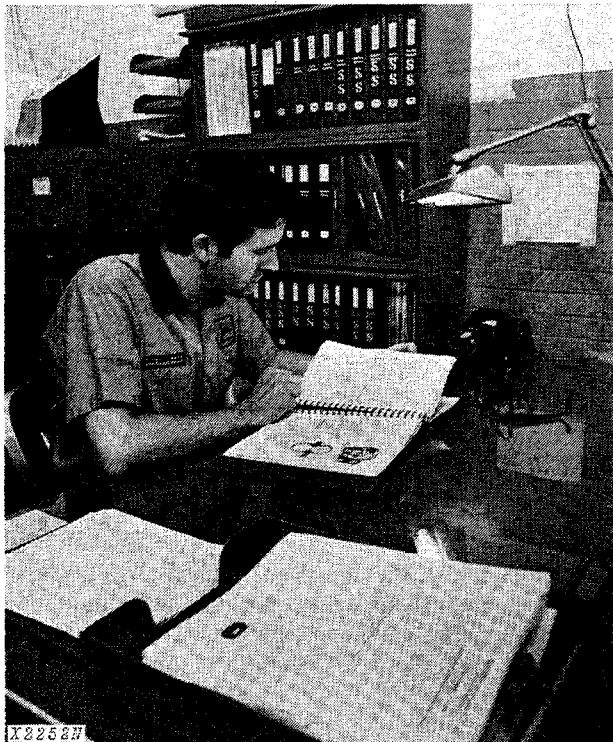

Use FOS Manuals for Reference

This technical manual is part of a twin concept of service:

The two kinds of manuals work as a team to give you both the general background and technical details of shop service.

•FOS Manuals—for reference

Fundamentals of Service (FOS) Manuals cover basic theory of operation, *fundamentals* of trouble shooting, *general* maintenance, and *basic* types of failures and their causes. FOS Manuals are for training new personnel and for reference by experienced service technicians.



When a service technician should refer to a FOS Manual for more information, a FOS symbol like the one at the left is used in the TM to identify the reference.

•Technical Manuals—for actual service

Technical Manuals are concise service guides for a specific machine. Technical manuals are on-the-job guides containing only the vital information needed by an experienced mechanic.



Use Technical Manuals for Actual Service

This technical manual was planned and written for you—an experienced service technician. Keep it in a permanent binder in the shop where it is handy. Refer to it whenever in doubt about correct service procedures or specifications.

Some features of this manual:

- Inside front cover - "Table of Contents".
- Section I - Contents, safety information, general specifications and general services.
- Sections 1 through 42 - Removal, repair, testing (components removed), installation, and adjustment.
- Section 90 - Detailed explanation of system operation, diagnosis, visual inspection, testing, and adjustments.
- Specifications grouped and illustrated at the end of each section.

<https://www.ebooklibonline.com>

Hello dear friend!

Thank you very much for reading.

Enter the link into your browser.

The full manual is available for immediate download.

<https://www.ebooklibonline.com>

MAINTENANCE WITHOUT ACCIDENT

Before servicing, adjusting, or repairing crawlers which have attachments such as buckets, etc.—**LOWER** attachments to the ground—or, if necessary to raise them for access to certain parts, **SECURELY SUPPORT** by external means. **DO NOT** rely on controls to support or position attachments for maintenance.

Never allow **ANYONE** to walk under equipment that is raised and not properly blocked.

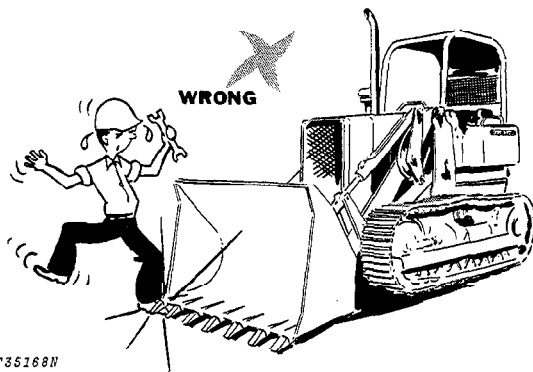

T35168N

Avoid working directly under raised and blocked equipment unless absolutely necessary.

If the machine is on an incline, block it securely.

Use hoisting equipment for lifting heavy parts. **TAKE CARE! WATCH OUT FOR OTHER PEOPLE IN THE VICINITY.**

Use extreme caution in removing radiator caps, drain plugs, grease fittings, or hydraulic pressure caps.

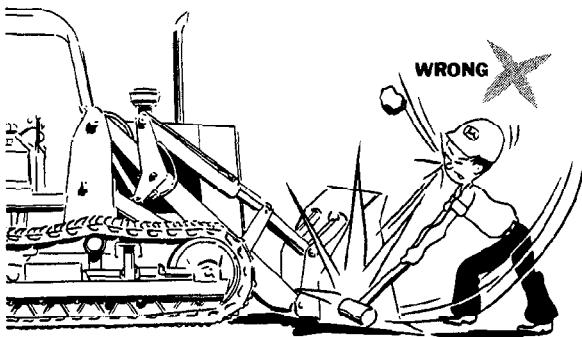

T35169N

Wear safety glasses when drilling, grinding, or hammering metal.

Make sure the maintenance area is adequately vented.

Keep maintenance area **CLEAN AND DRY**. Oily and wet floors are slippery; greasy rags are a fire hazard; wet spots are dangerous when working with electrical equipment.

Store starting aids in a cool and well-ventilated place, out of the reach of unauthorized personnel.

SERVICING PRECAUTIONS

Stop the engine before cleaning or lubricating the equipment.

Lower mounted equipment and tools to the ground *carefully*.

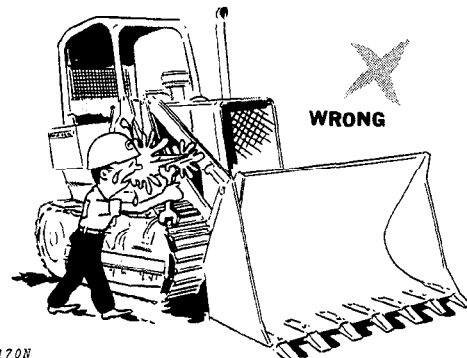

T35170N

Engine coolant gets hot! Don't remove the radiator cap until coolant temperature is below the boiling point. Then turn cap slightly to relieve pressure before removing.

Exhaust gases are dangerous! Periodically check exhaust system for excessive leakage.

Don't forget a hydraulic system may be pressurized! To relieve pressure, shut off engine and move control levers until hydraulic functions do not respond.

When checking hydraulic pressure, be sure to use the correct test gauge for the pressure in the particular system.

MAINTENANCE WITHOUT ACCIDENT

Keep ALL equipment free of dirt and oil. This attention will minimize fire hazards and facilitate spotting of loose or defective parts.

When preparing engine for storage, remember that inhibitor is volatile and therefore dangerous. Seal and tape openings after adding the inhibitor. Keep container tightly closed when not in use.

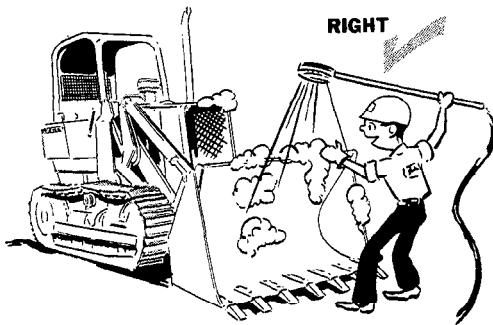

T35171N

ADJUSTING PRECAUTIONS

... for Operating Adjustments

Keep clutch and brake control units properly adjusted at all times. Before making adjustments, stop engine.

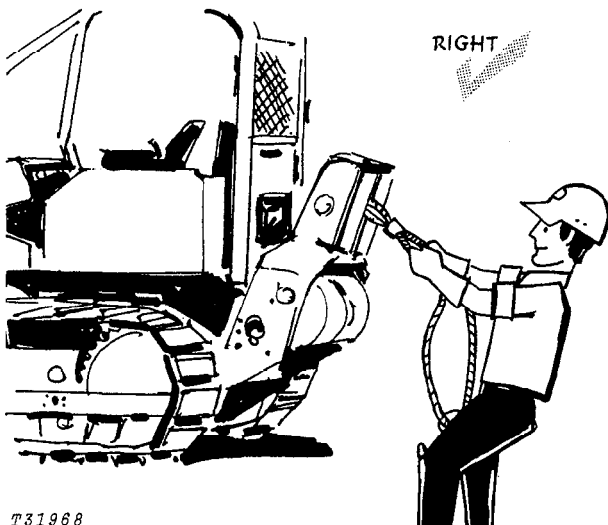

T31968

Always Wear Gloves When Handling Cable.

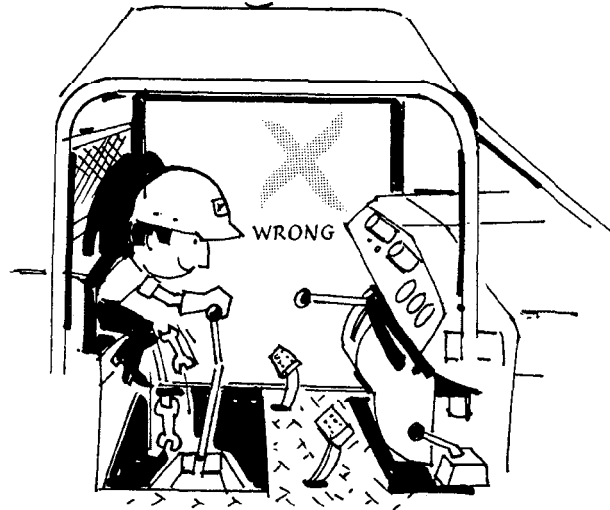

T31969

Before removing any housing covers, stop engine. Take all objects from your pockets which could fall into the opened housings. Don't let adjusting wrenches fall into opened housings.

... for Maintenance Adjustments

Don't attempt to check belt tension while the engine is running.

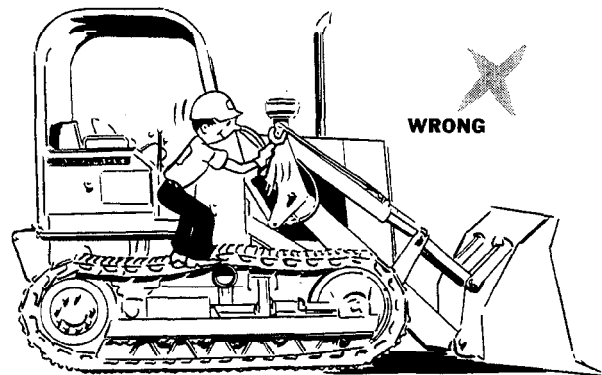

T35172N

Don't adjust the fuel system while the machine is in motion.

MAINTENANCE WITHOUT ACCIDENT

PRECAUTIONS DURING REPAIR

Before working on the engine fuel system—close fuel shutoff valve.

Before working on hydraulic system—make sure engine is not running and the system pressure is relieved by working the control levers in all directions with the engine shut off.

Before repairing the electrical system, or performing a major overhaul, make sure the batteries are disconnected.

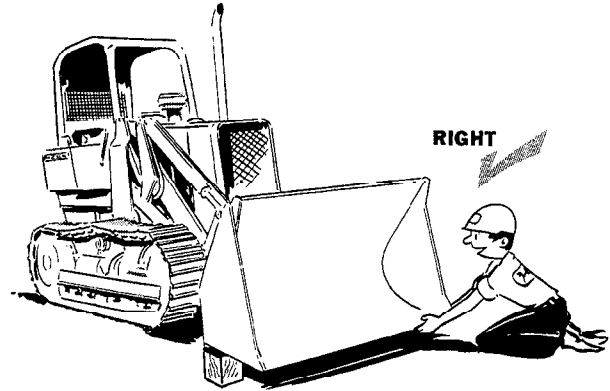

T35174N

When changing cutting edges on the bucket—

Stop the engine and securely block the bucket.

Never let your bare hands come in contact with the sharp edges. WEAR GLOVES.

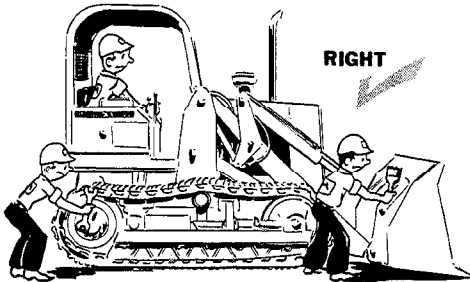

T35173N

Keep all equipment free of dirt and oil. This attention will minimize fire hazards and facilitate spotting of loose or defective parts.

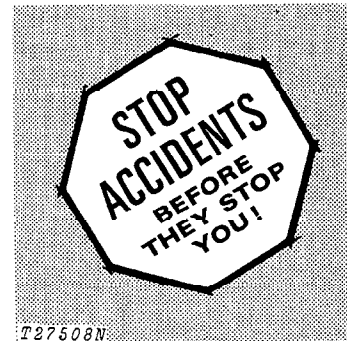

T27508N

MAINTENANCE WITHOUT ACCIDENT

KNOW EQUIPMENT IS READY!

Check guards, ROPS, safety bars—all protective devices installed on the crawler. Every one should be in place and secure.

CHECK IT OUT!

- GUARDS
- SHIELDS
- PROTECTIVE DEVICES
- ROLL-OVER PROTECTIVE STRUCTURES
- SEAT BELTS, ETC.

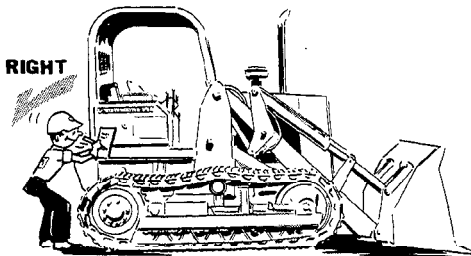

T35175N

Carefully inspect equipment for visual defects—leaks in fuel, lubrication, and hydraulic systems. Do not search for pressurized fluid leaks with your hands. Use cardboard or wood to search for leaks.

Check and secure all caps and filler plugs for fuel, oils, radiator, etc.

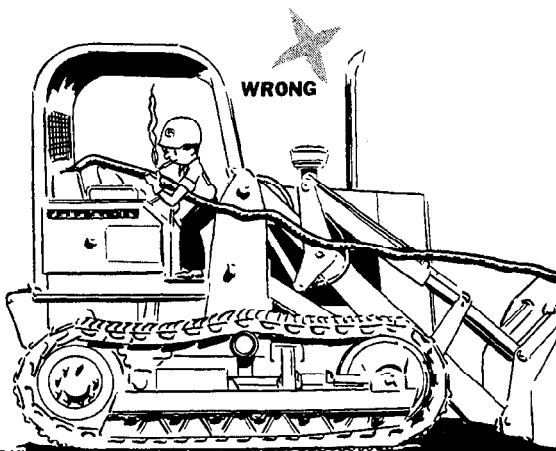

T35176N

Check levels of fuel, coolant, hydraulic fluid, and lubricating oil. If fuel must be added—**FIRST, PUT OUT THAT CIGARET.**

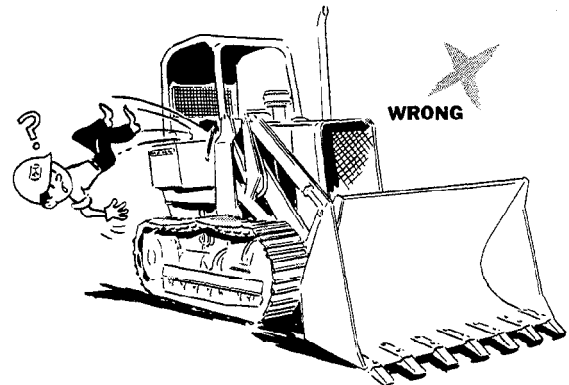

T35177N

Be sure to clean any oil, grease or mud accumulation from floor of operator's compartment, stepping points, and grab rails to minimize the danger of slipping.

In freezing weather beware of snow or ice deposits on stepping points, grab rails, and floor.

Remove loose bolts, tools, or other objects from floor of operator's compartment.

Although it is impractical to try to cover every possible maintenance situation, the safety precautions recommended here should serve to develop and promote safe maintenance procedures.

The information contained in this manual is not intended to replace safety codes, insurance requirements, federal, state, and local laws, rules and regulations. In particular, your service area or jobsite activities may be subject to state safety rules and/or federal regulation under the Occupational Safety and Health Act (OSHA). Familiarize yourself with all regulations applicable to your situation in order to avoid possible safety violations.

Illustrations and copy reproduced in part by permission of Construction Industry Manufacturers' association (CIMA).

Group III

GENERAL SPECIFICATIONS

(Specifications and design subject to change without notice. Wherever applicable, specifications are in accordance with ICED and SAE standards. Except where otherwise noted, these specifications are based on a unit equipped with 1-1/4 cu. yd. (0.96 m³) digging bucket with teeth, roll-over protective structure and standard equipment.)

Power (@ 2,200 engine rpm):	SAE	DIN
Gross	80 hp (59.7 kW*)	
Net	72 hp (53.7 kW*)	73 PS

Net engine flywheel power is for an engine equipped with fan, air cleaner, water pump, lubricating oil pump, fuel pump, alternator and muffler. The gross engine power is without fan. Gross and net flywheel power ratings are under SAE standard conditions of 500-ft. (152 m) altitude and 85°F (29°C) temperature and DIN 70 020 conditions (non-corrected). No derating is required up to 10,000 feet (3000 m) altitude.

**In the international system of units (SI), power is expressed in Kilowatts (kW).*

ENGINE:

John Deere, 4-cylinder, turbocharged diesel, 4-stroke cycle

Bore and stroke	4.19 x 5.00 in. (106.4 x 127 mm)
Piston displacement	276 cu. in. (4 523 cm ³)
Compression ratio	16.2 to 1
Maximum torque @ 1,200 rpm	230 lb-ft (31.8 kg-m)
NACC or AMA (U.S. Tax) horsepower	28
Lubrication	Pressure system with full-flow filter and cooler
Main bearings	5
Cooling	Pressurized with dual thermostat and controlled bypass
Fan	Blower
Air cleaner with restriction indicator	Dry
Electrical system	12-volt
Battery	Reserve capacity: 180 minutes

TRANSMISSION:

Converter-driven, 3-speed forward and reverse, Power Shift.

STEERING:

Steering clutches and brakes are controlled by a single pedal for each track. A separate pedal provides braking, and lockdown for parking.

Clutches . . . Oil-cooled, hydraulically-actuated, multiple-disk, 11-in. (279 mm) disks; 16 friction surfaces per clutch.

Brakes . . . Self-adjusting, self-energizing, oil-cooled contracting band with bonded lining.

TRAVEL SPEEDS:

	Forward		Reverse	
	mph	km/h	mph	km/h
1st	2.01	3.23	2.42	3.89
2nd	3.26	5.25	3.90	6.28
3rd	5.63	9.06	6.75	10.86

HYDRAULIC SYSTEM:

Control	Triple hydraulic valve with single-lever bucket control and third function control
Pump	Gear, 28 gpm (106 Lpm)
Pressure	2,250 psi (158.2 kg/cm ²)
Oil lines	Seamless steel tubing; double-wire braid hose
Filter	Micronic in return line

HYDRAULIC CYLINDERS:

	Bore	Stroke
Boom, two	4.25-in. (108 mm)	28.25-in. (718 mm)
Bucket, two	3.5 in. (89 mm)	31.1-in. (790 mm)
Cylinder rods	Ground, heat-treated, chrome-plated, polished	
Boom cylinder rods	2.25-in. (57 mm) dia.	
Bucket cylinder rods	1.75 in. (44.5 mm) dia.	

TRACKS (5-roller track frames with rock guards):
 Triple semi-grouser,
 open-center 14-in. (356 mm)
 Track shoes, each side 37
 Ground contact area 2,128 sq. in. (13 729 cm²)
 Ground pressure 8.2 psi (0.58 kg/cm²)
 Length of track on ground 76 in. (1.93 m)
 Track gauge 52 in. (1.32 m)
 Carrier roller 1
 Adjustment Hydraulic
 Clearance at rear crossbar 14.25 in. (362 mm)

BUCKETS:	SAE Heaped	
	Capacity	Width
Digging	1-1/4 cu. yd. (0.96 m ³)	72.25 in. (1.84 m)
Light Materials	1-3/4 cu. yd. (1.34 m ³)	78.25 in. (1.99 m)
Multi-purpose	1-1/4 cu. yd. (0.96 m ³)	73 in. (1.85 m)

OPERATING INFORMATION:

Breakout force 15,750 lb. (7 144 kg)
 Lifting capacity, full height 10,600 lb. (4 808 kg)
 Maximum dumping angle 50 deg.
 Raising time 7.0 sec.
 Dumping time 1.6 sec.
 Lowering time 4.0 sec.

CAPACITIES:	U.S.	Litres
Cooling system	5 gal.	18.9
Fuel tank	36 gal.	136.3
Crankcase including filter	15 qt.	14.2
Transmission (total capacity)	13.5 gal.	51.1
Final drive (each)	7 qt.	6.6
Hydraulic reservoir	7 gal.	26.5
Hydraulic system	13 gal.	49.2
Steering clutch housing		
(each side)	28 qt.	26.5
Winch reservoir	9 qt.	8.5
SAE operating weight with ROPS	18,225 lb.	(8 267 kg)

ADDITIONAL STANDARD EQUIPMENT:

Front bottom guard
 Front hitch
 Cushion seat with arm rests
 Key switch with push-button start switch
 Precleaner
 Electric hour meter
 Cigar lighter
 Vandal protection
 Bottom guard counterweight with fixed drawbar
 Bucket level indicator
 Radiator sand shield
 Sprocket weights
 Lights
 Enclosed alternator with solid state regulator
 Engine side shields
 Boom safety lock bar
 Muffler
 Tachometer
 Cold weather starting aid
 Front idler shields
 Master electrical disconnect switch
 Return-to-dig
 Decelerator
 Pedal steering

SPECIAL EQUIPMENT:

13-in. (330 mm) rubber shoes
 Cab (includes ROPS)
 Winch drive
 Two batteries
 Rear counterweight for multi-purpose bucket or log loader
 Brush screens
 Limb risers with overhead exhaust

LOADER OPERATING DIMENSIONS

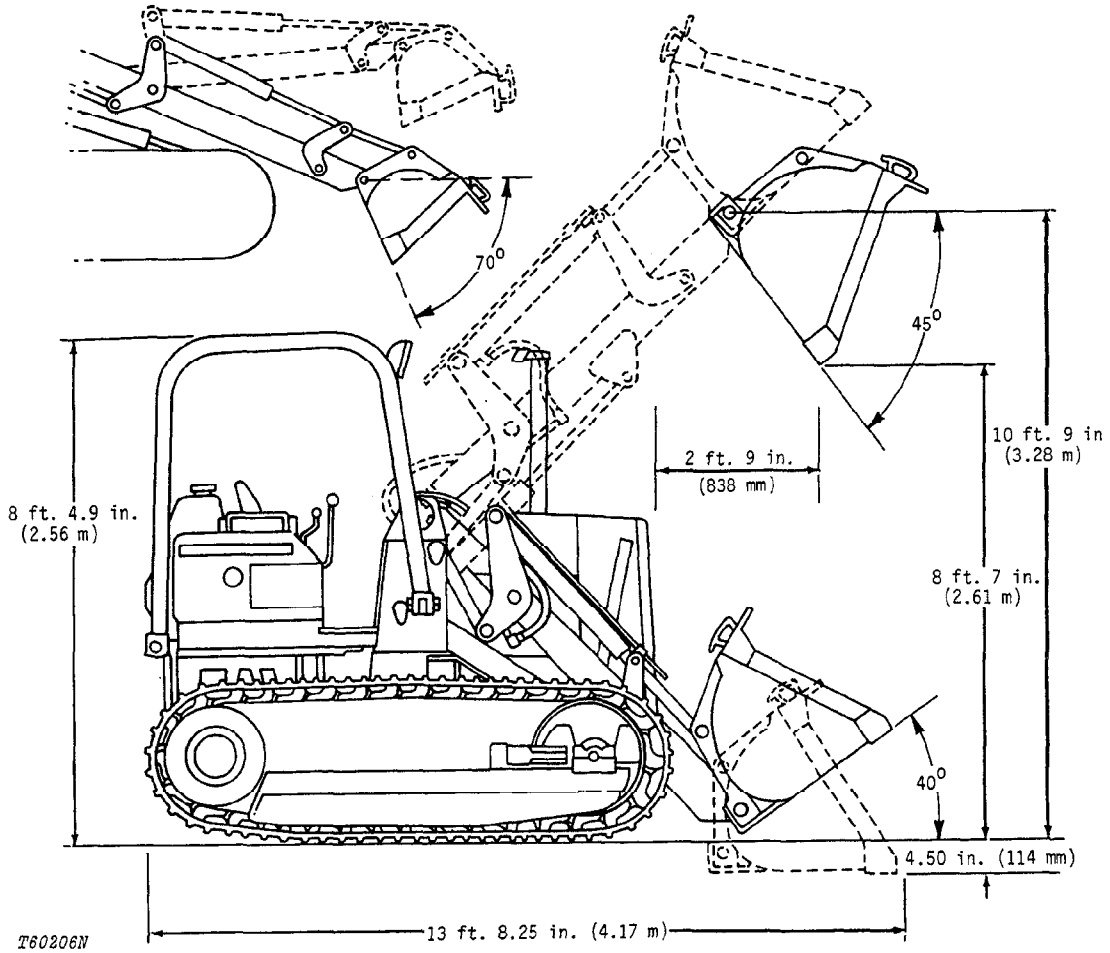

3110 RIPPER DIMENSIONS

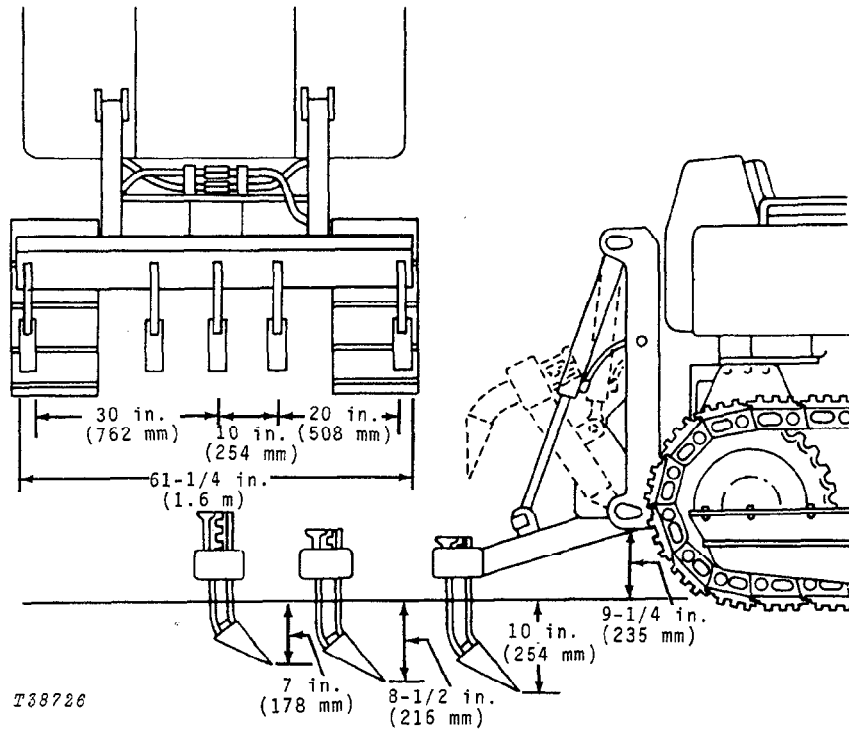

Width (overall)	66 inches (1.7 m)
Working width (max.)	61-1/4 inches (1.6 m)
Penetration (Adjustable)	7, 8-1/2, 10 inches (178, 216 and 254 mm)
Cylinders	Double-Acting
Bore	2-1/2 inches (63.5 mm)
Stroke	15 inches (381 mm)
Weight with three teeth	685 pounds (311 kg)
Ground clearance at frame	9-1/4 inches (235 mm)

9300 BACKHOE SPECIFICATIONS

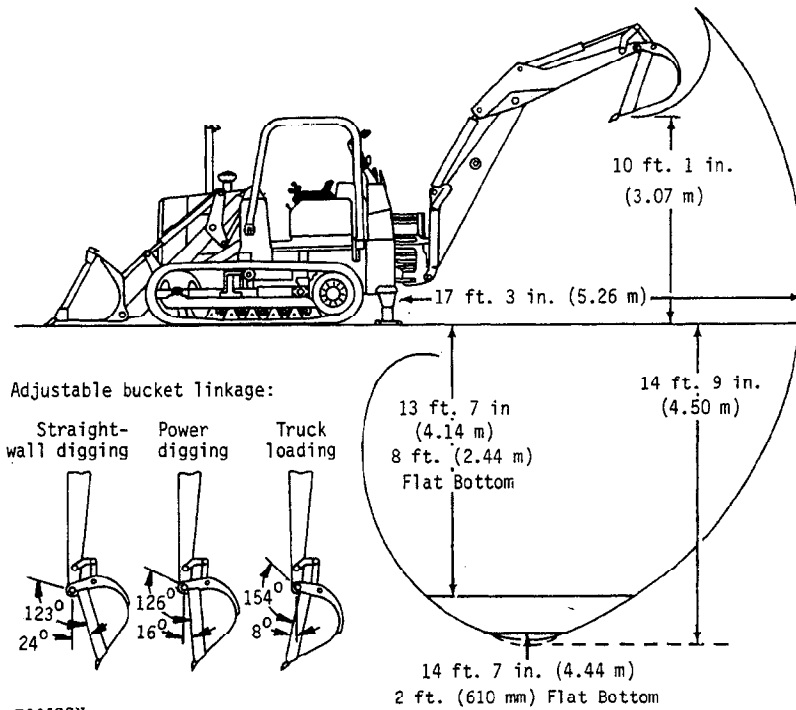

T60533N

Operating Information:

Digging Depth (ICED):

Maximum	14 ft. 9 in. (4.50 m)
2-ft. (610 mm) flat bottom	14 ft. 7 in. (4.44 m)
8-ft. (2.44 m) flat bottom	13 ft. 7 in. (4.14 m)
Swing arc	180 deg.
Digging force (bucket cylinder), ICED	9226 lb. (41.35 kN) (4185 kg)
Digging force, crowd cylinder	5835 lb. (26.15 kN) (2647 kg)
Reach from center of swing mast, ICED	17 ft. 3 in. (5.26 m)
Loading height, ICED	10 ft. 1 in. (3.07 m)
Transport height	11 ft. 1 in. (3.38 m)

Hydraulic System

Pressure	2250 psi (155.1 bar) (158.2 kg/cm ²)
Pump	28 gpm (106 L/min) @ 2500 engine rpm

Hydraulic Cylinders:

	Bore	Stroke	Rod Diameter
Boom	4.5-in. (114 mm)	34-in. (864 mm)	2.25-in. (57 mm)
Crowd	4-in. (102 mm)	33-in. (838 mm)	2-in. (51 mm)
Bucket	3.5-in. (89 mm)	27.37-in. (695 mm)	2.25-in. (57 mm)
Stabilizer	4-in. (102 mm)	16.62-in. (422 mm)	2-in. (51 mm)

Swing cylinder Rotary vane-type; built-in automatic swing cushion
Cylinder rods.....Ground, heat-treated, chrome-plated, polished

Stabilizer Width:

Transport position	7 ft. 3 in. (2.21 m)
Operating position (overall)	10 ft. 6 in. (3.20 m)
Operating position (ICED)	9 ft. 1 in. (2.77 m)

Buckets:

	Width		Struck Capacity	
	in.	mm	cu. ft.	m ³
Standard	12	305	2.5	0.071
	16	406	3.6	0.102
	18	457	4.4	0.125
	24	610	6.0	0.170
	30	762	7.6	0.215
Heavy-duty	36	914	7.2	0.204
	18	457	4.4	0.125
	24	610	6.0	0.170
Ejector	30	762	7.6	0.215
	24	610	4.2	0.119

Attachments:

Ripper tooth replaces backhoe bucket. Cast steel, 225 lb. (102 kg) tooth has hardened replaceable tip. Bolt-on rubber street pads for stabilizer pads.

Shipping Weight:

Exclusive of mounting parts, bucket, and front counterweights 3200 lb. (1452 kg)

LUMBER FORK (WITH CLAMP) DIMENSIONS

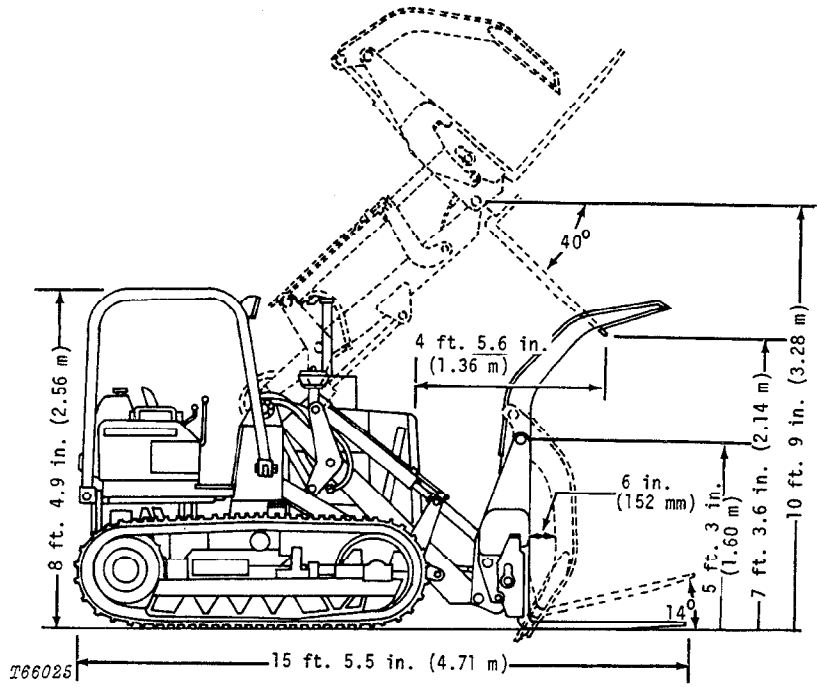

Group IV PREDELIVERY, DELIVERY, AND AFTER-SALE SERVICES

TEMPORARY STORAGE

After receiving your crawler from the factory and before putting the crawler into temporary storage, perform the following checks:

1. Check battery electrolyte level and charge the battery, if necessary.
2. Check the level of coolant in the radiator. The coolant should be maintained at a level midway between the radiator core and filler neck.
3. Fill the fuel tank.
4. Check crankcase oil level. Oil should be at top mark of dipstick after crawler has been shut down for 10 minutes.
5. Relieve hydraulic pressure by stopping engine, lowering all equipment and operating control levers until system fails to respond.

PREDELIVERY SERVICE

Because of the shipping factors involved, plus extra finishing touches that are necessary to promote customer satisfaction, proper predelivery service is of prime importance to the dealer and the customer.

Use the following list when preparing a crawler for delivery to the customer.

1. Air Cleaner

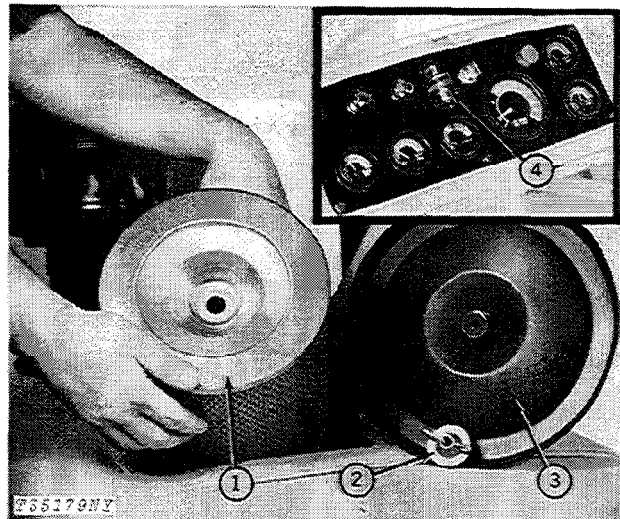

- | | |
|-----------------------|-------------------------|
| 1—Primary Filter | 3—Air Cleaner Cover |
| 2—Gasket and Wing Nut | 4—Restriction Indicator |

Fig. 1—Air Cleaner Primary Element

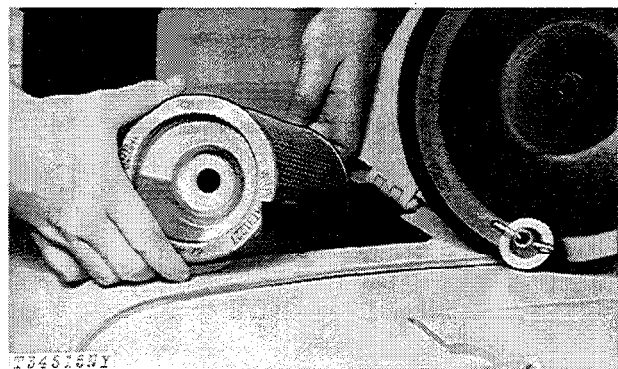

Fig. 2—Air Cleaner Safety Element

Check air filter restriction indicator. If red signal locks in full view, remove primary element and clean.

Air cleaner element checked Yes No

2. Pre-Cleaner

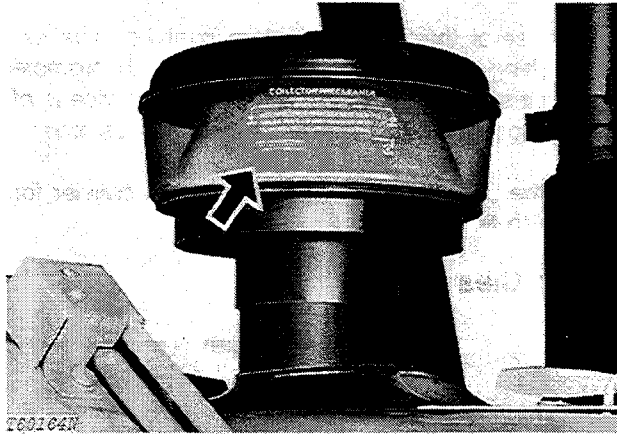

Fig. 3-Pre-Cleaner Attachment

Check the pre-cleaner and empty if necessary.

Pre-cleaner cleaned out Yes No

3. Fuel Filter

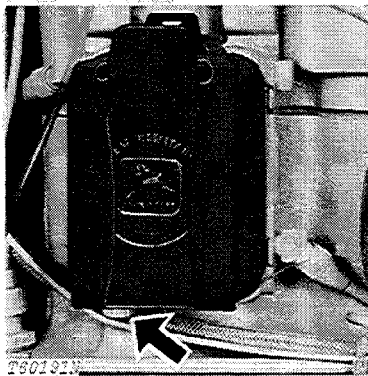

Fig. 4-Fuel Filter Drain Plug

Check fuel filter for sediment and drain, if necessary. Bleed fuel system after draining. See page I-IV-30.

Sediment present in filter Yes No

4. Battery

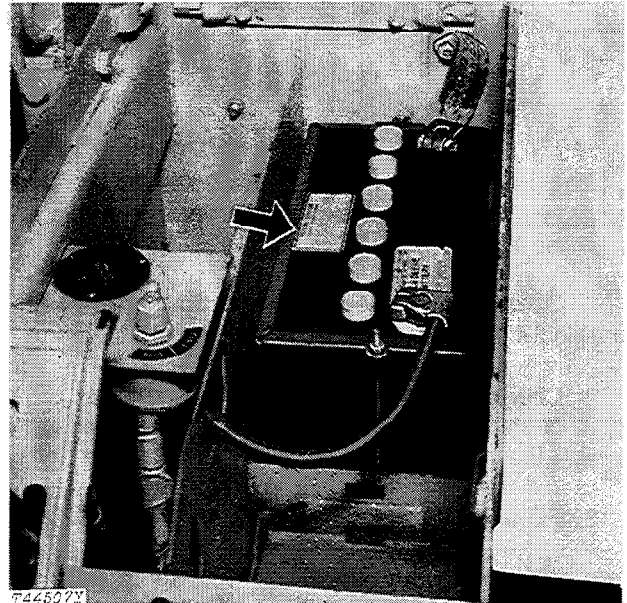

Fig. 5-Batteries

Check battery electrolyte level. If distilled water is not available, use clean soft water. Avoid use of hard water. Remove foreign material from top of battery and coat terminals with petroleum jelly. Check vent holes in battery caps.

IMPORTANT: Never add water to battery in freezing weather unless engine is to be run 2 or 3 hours to assure mixing of water and electrolyte.

Check battery connections.

Punch date code on battery.

Water added Yes No

Battery connections checked Yes No

8. Air Intake Hoses

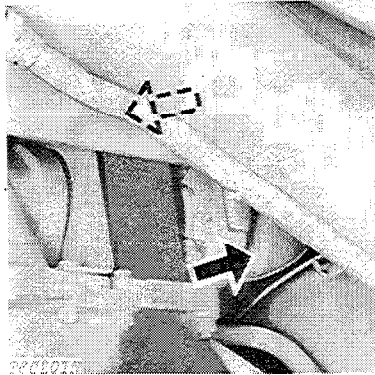
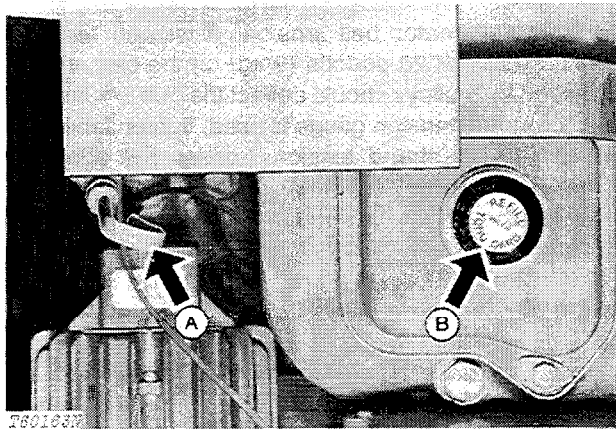

Fig. 9-Hose Clamps

Check clamps on hose which connects air cleaner and engine. Tighten hose clamps where necessary. Inspect hoses for cracks.

Air intake hose checked	Yes	No
Loose connections	Yes	No

9. Crankcase Oil Level



A—Dipstick

B—Oil Filler Cap

Fig. 10-Crankcase Oil Level

NOTE: Access to the crankcase dipstick and oil filler cap is obtained through a cover in the hood.

Check crankcase oil level with unit on level ground and engine off. If oil level is at or below bottom mark on dipstick, add sufficient oil of the proper viscosity and type specified on page I-V-2 to bring oil level to between marks on dipstick. Do not operate engine with oil level below the bottom mark.

Crankcase oil level checked	Yes	No
Oil added, if any	_____	qts. (L)

10. Hydraulic Reservoir Oil Level

Oil level should be halfway up in oil level window with the bucket rolled back on the ground.

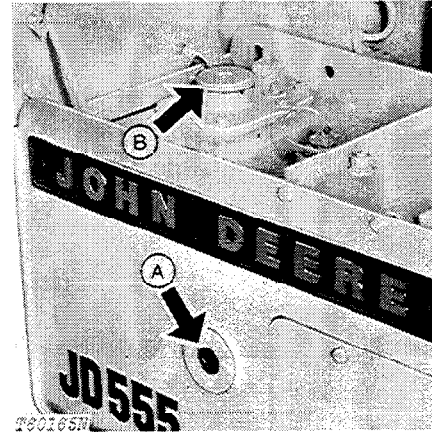

A—Oil Level Window

B—Filler Cap

Fig. 11-Hydraulic System Oil Level

IMPORTANT: If the JD555 is equipped with a backhoe, the backhoe must be in transport position to obtain correct oil level reading.

To add oil, turn latch and lift reservoir cover. Turn pressure cap slowly and remove it. Add oil specified on page I-V-2 until oil level reaches half circle on window.

IMPORTANT: Do not operate crawler without oil in reservoir. Doing so will damage the hydraulic system.

Oil level checked	Yes	No
Oil added, if any	_____	qts. (L)

11. Transmission Oil Level

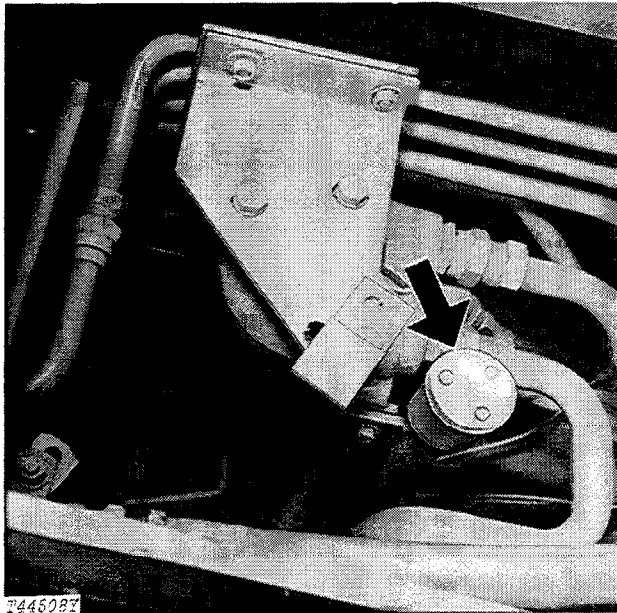

Fig. 12-Transmission Oil Dipstick

The transmission dipstick is accessible by lifting the seat cushion up. The correct oil level check is made with the dipstick resting on the tiller tube.

Perform both of the following transmission oil level checks:

(a) Before starting the engine, check the oil level with dipstick. If the oil level is at or near the upper (FULL) mark, there is sufficient oil in the system to permit starting the engine. If oil level is low, add transmission oil of the type specified on page I-V-2. Replace dipstick.

(b) Operate crawler until the transmission reaches normal operating temperature—transmission temperature gauge needle a minimum of 1/4 way up in light green zone. With the engine idling, transmission locked in neutral and the parking brake set, check the transmission oil level.

Oil level should now be at or above the lower (ADD) mark and not above the upper (FULL) mark on the dipstick. If necessary, add fluid of the type specified on page I-V-2. Do not overfill.

Oil level checked _____ Yes No
 Oil added, if any _____ qts. (L)

12. Winch Housing Oil Level

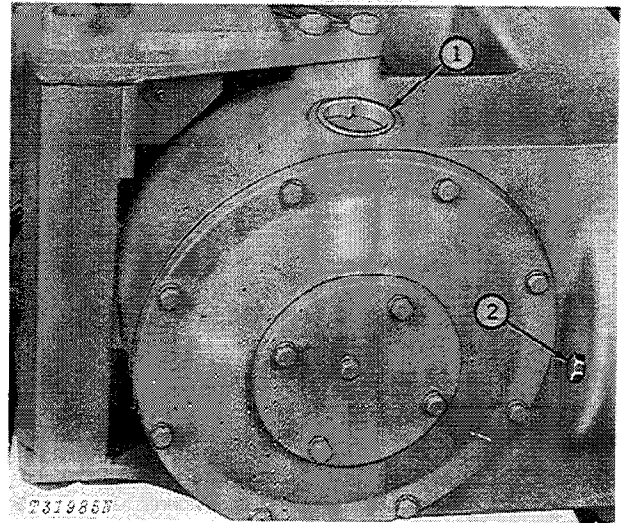

1—Filler Plug

2—Oil Level Plug

Fig. 13-Winch Oil Level

Check oil level of winch housing by removing the oil level plug. If necessary, remove the filler plug and add oil as specified on page I-V-2 until oil is to level of oil level hole.

Oil level checked _____ Yes No
 Oil added, if any _____ qts. (L)

13. Fuel Tank Sump

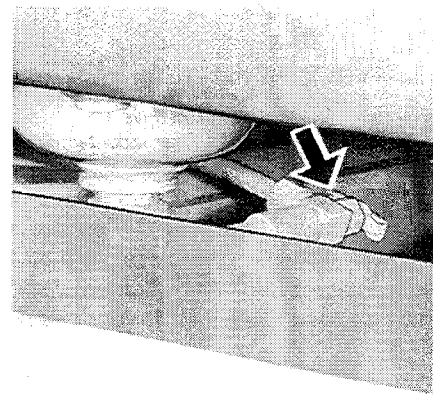

Fig. 14-Fuel Tank Sump Drain Cock

Drain sump after crawler has been shut down 3-4 hours. Open drain cock under seat. Drain fuel until it is clear of water, dirt, etc. Close drain cock.

Fuel sump drained _____ Yes No

14. Final Drives

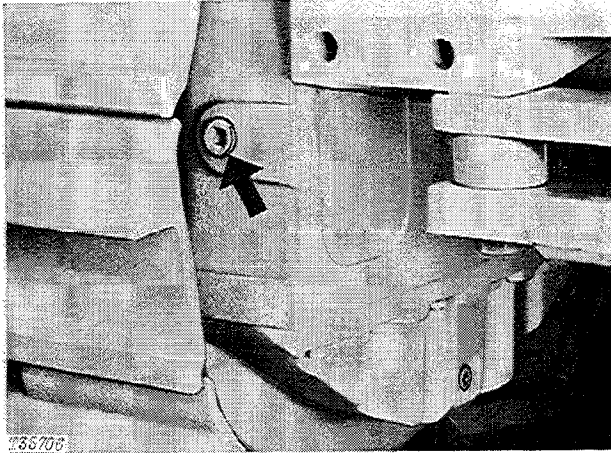

Fig. 15-Final Drive Oil Level Check Plug
 (Without Rear Mounted Equipment)

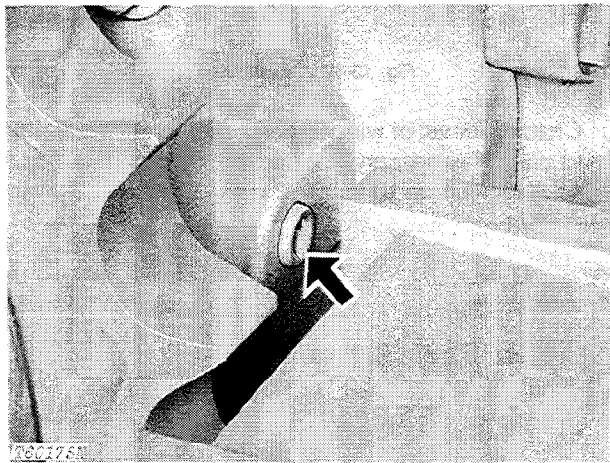

Fig. 16-Final Drive
 Oil Level Check Plug (With Rear Mounted Equipment)

NOTE: Whenever the crawler is equipped with rear mounted equipment, the oil level may be checked at the front check plug (Fig. 16). When the crawler is not equipped with rear mounted equipment, it is easier and faster to check the oil level at the rear check plug (Fig. 15).

The oil level in the final drives should be maintained at the level of the oil level hole. Check oil level and if necessary, add oil specified on page I-V-2 to bring oil to this level.

Oil level checked	Yes	No
Oil added, if any	_____	qts. (L)

15. Lights

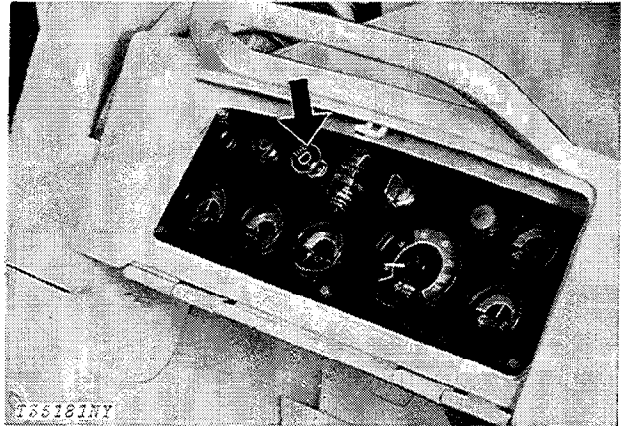
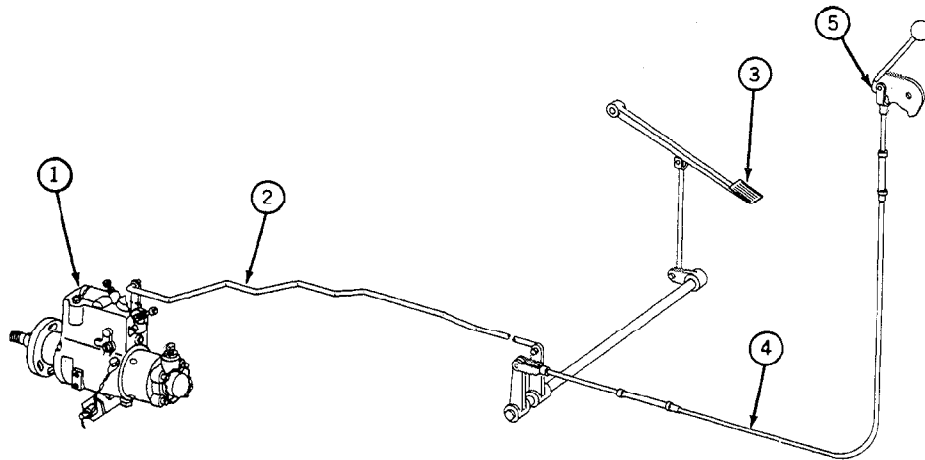

Fig. 17-Light Switch

Pull out switch knob to turn on lights. Push in switch knob to turn off lights. The key switch must be in the "on" position before the lights will operate.

Lights operational	Yes	No
--------------------	-----	----

16. Engine Speed Control



T34528N

1—Injection Pump
2—Speed Control Rod

3—Decelerator Pedal
4—Control Cable

5—Speed Control Lever

Fig. 18-Speed Control Linkage

Adjust speed control linkage as follows:

Unit With Decelerator Pedal:

With injection pump lever in fast idle position, the lever arm of the inside bell crank should be angled approximately 15° to the rear.

Push speed control lever forward to stop (fast idle position).

Align cable yoke with bell crank hole and tighten yoke four turns to allow for free travel.

Unit Without Decelerator Pedal:

Push speed control lever forward (fast idle position).

With injection pump lever in fast idle position, align cable yoke to pump lever and tighten yoke four turns to allow for free travel.

NOTE: Slow idle cannot be adjusted by the speed control linkage. If fast idle is adjusted properly slow idle will automatically be adjusted.

Speed control linkage adjusted

Yes No

17. Transmission Shifting



Fig. 19-Transmission Control Lever

The crawler has three speeds forward and three speeds reverse.

Shift the crawler from first and second reverse to first and second forward. Shift from third forward or reverse to a speed in the opposite direction by shifting into second before changing direction.

Transmission operational

Yes No

18. Gauge Operation

When operating the crawler, check the following gauges for correct operation.

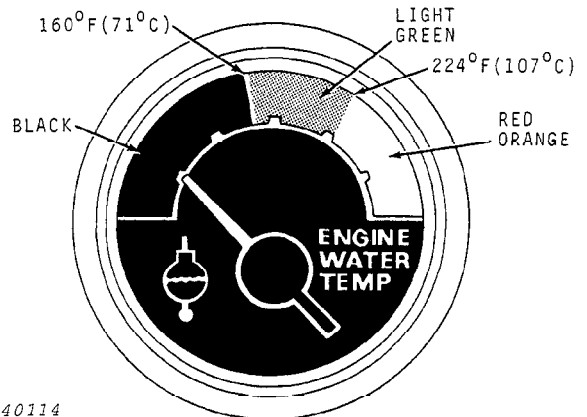

T40114

Fig. 20-Engine Coolant Temperature Gauge

Normal operating range is indicated by the light green zone on the gauge face.

If engine coolant temperature indicator hand is not in the green zone, stop engine and check cooling system.

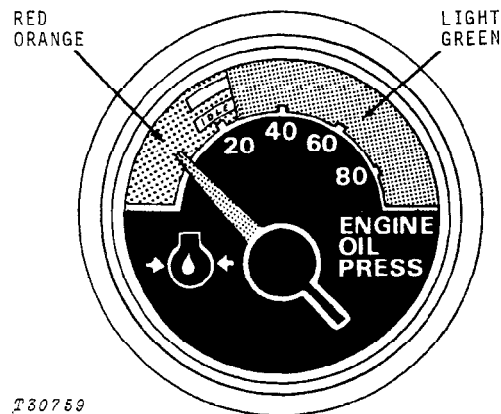

T30759

Fig. 21-Engine Oil Pressure Gauge

Normal operating range is indicated by the light green zone on the gauge face.

If engine oil pressure indicator hand is not in the green zone, stop engine and check oil level.

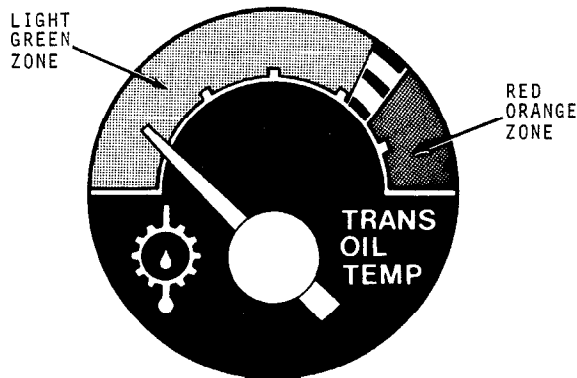

T34530N

Fig. 22-Transmission Temperature Gauge

Normal operating range is indicated by the light green zone on the gauge face.

If transmission temperature indicator hand is not in the green zone, stop engine and check oil level.

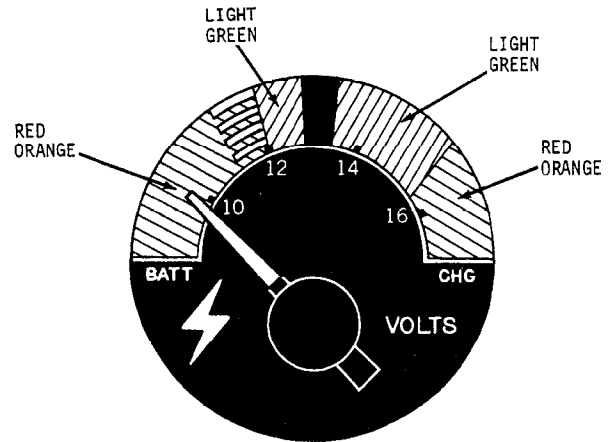

T44558

Fig. 24-Voltmeter

Normal operating range is indicated by the right light green zone on the gauge face.

If voltmeter indicator hand is not in the green zone, trouble shoot the electrical system.

All gauges operational

Yes No

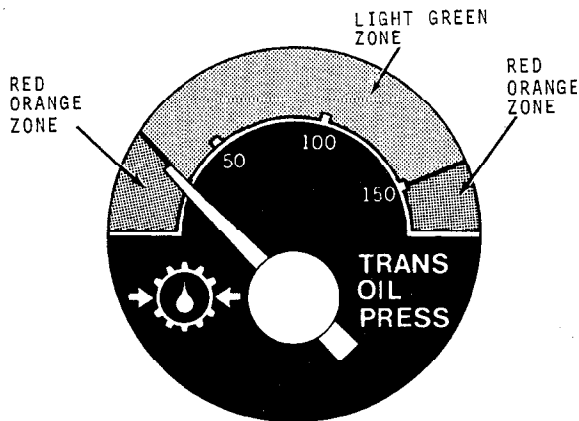

T34531N

Fig. 23-Transmission Oil Pressure Gauge

Normal operating range is indicated by the light green zone on the gauge face.

If transmission oil pressure indicator hand is not in the green zone, stop engine and check oil level.

19. Brakes

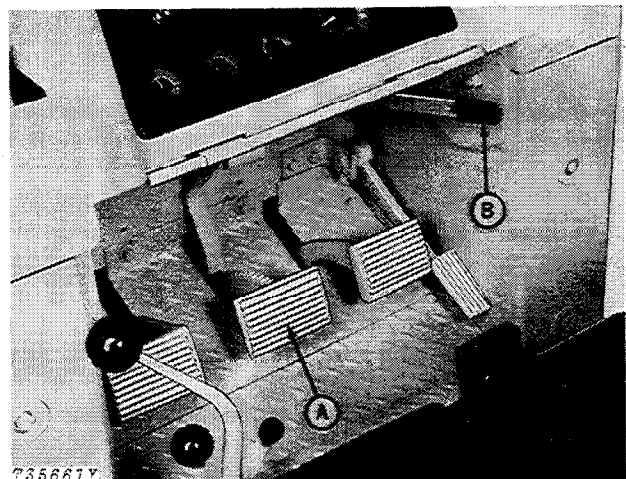

T35661Y

A—Park Brake Pedal

B—Park Brake Lever

Fig. 25-Brakes

Apply park brake pedal and lever. Park brake should hold crawler from moving. If not, brakes need adjusting.

Brakes operational

Yes No

20. Steering Adjustment

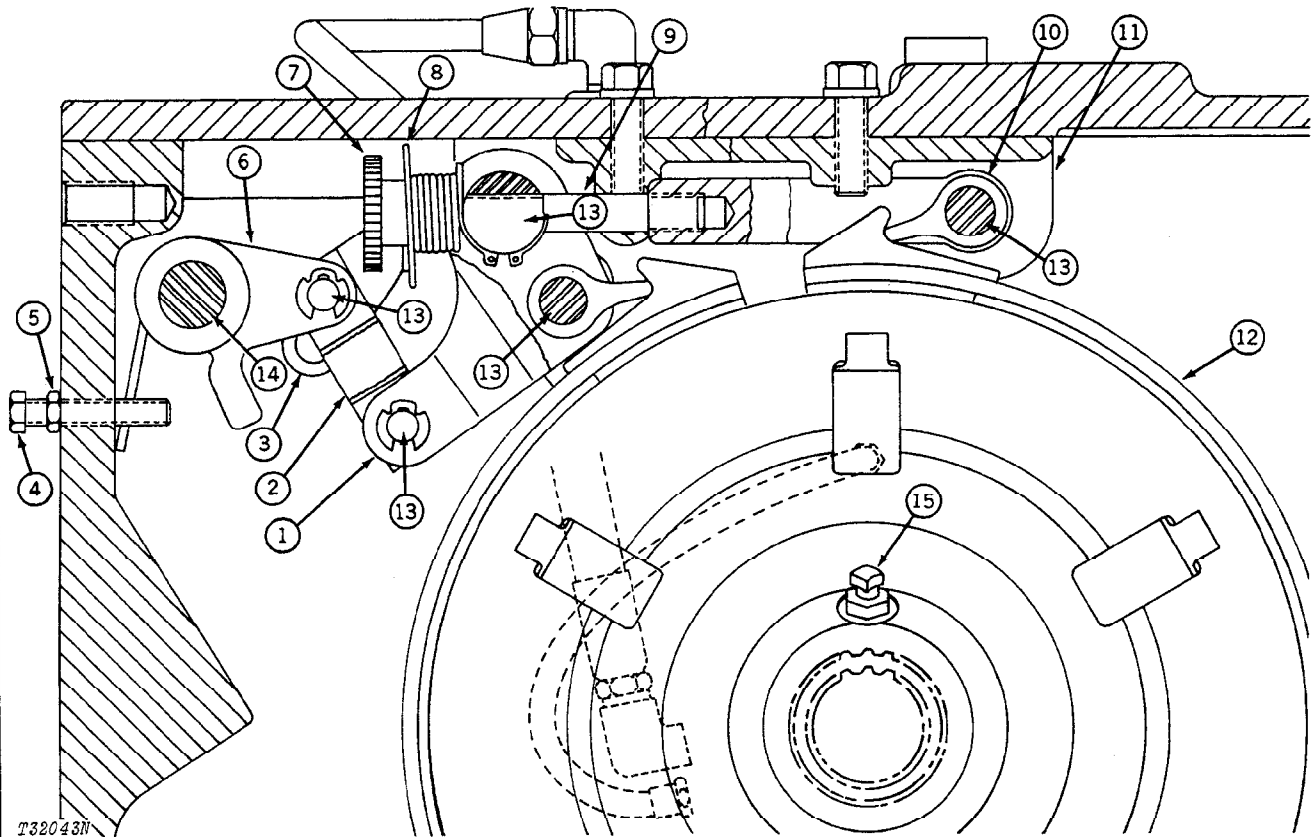

T32043N

- 1—Brake Band Yoke
- 2—Link
- 3—Adjusting Link
- 4—Brake Lever Adjusting Screw
- 5—Jam Nut

- 6—Brake Lever
- 7—Adjusting Nut
- 8—Spring
- 9—Stud
- 10—Brake Strut

- 11—Brake Anchor
- 12—Brake Band
- 13—Pin
- 14—Brake Lever Shaft
- 15—Brake Drum Set Screw

Fig. 26-Steering-Brake Assembly

The steering should be adjusted so that the brakes start to pick up at 2.5 in. (63.5 mm) of pedal travel.

If adjustment is required, proceed as follows:

NOTE: Adjust one side at a time.

1. Tighten adjusting nut (7, Fig. 26) so brakes start to pick up at 2.5" (63.5 mm) pedal travel.

2. Tighten adjusting nut one notch more to insure that adjusting link (3) is against bottom of adjusting nut.

3. Loosen jam nut (5) and turn brake lever adjusting screw (4) in two turns, or far enough so the brakes will NOT self-adjust.

NOTE: Step 4 will require two service technicians.

4. While driving the crawler forward, repeatedly push pedal to the stop. Check if adjusting link (3) is picking up the next notch in the adjusting nut.

If necessary, repeat procedure after backing out adjusting screw (4) in quarter-turn increments until the adjusting link just picks up the next notch on the adjusting nut. Then lock the adjusting screw by tightening jam nut (5).

5. After the adjusting screw is set and locked in position, back off the adjusting nut so the pedals can be pushed down to the stop with little effort. Readjust pedal travel so bottom of pedal is 0.30" (7.62 mm) above floor when brake stop is contacted.

6. Readjust the brake adjusting nut so the brakes start to engage at 2.5" (63.5 mm) pedal travel.

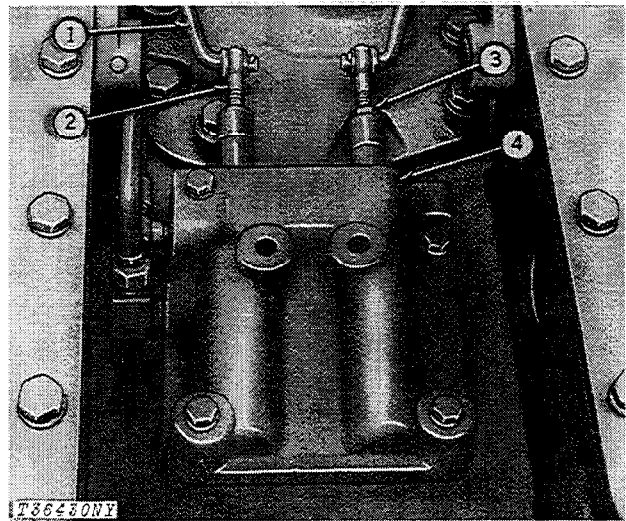

1—Steering Valve Rods 3—Lock Nut
2—Steering Valve Eyebolts 4—Steering Valve Housing

Fig. 27-Steering Valve Spool Adjustments

Refer to Fig. 27 and adjust the steering valve spool. Start the engine and place the transmission in first gear and the reverser in gear. Set the foot brake and lock it down.

Adjust the steering valve spools so that the clutches are engaged when the tops of the steering pedals are 1.5 inches (38 mm) from the "at rest position" and disengaged when the tops of the pedals are 2.5 inches (63.5 mm) from the "at rest position".

Steering adjusted

Yes No

21. Loader Control Lever

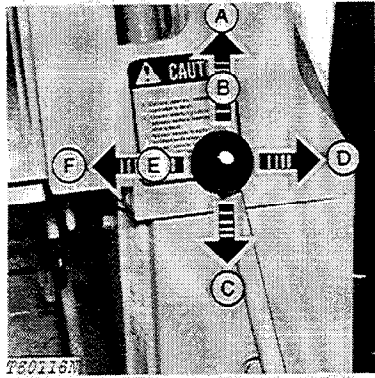

- A—Float
- B—Lower
- C—Raise
- D—Dump
- E—Retract
- F—Return-to-Dig

Fig. 28-Loader Control Lever

Push lever forward to lower boom and pull it rearward to raise boom. Lever should automatically return to neutral when released.

Push lever to right to dump and pull it to the left to retract the bucket or fork. Lever should automatically return to neutral when released.

Loader control lever operational Yes No

22. Attachment Control Lever

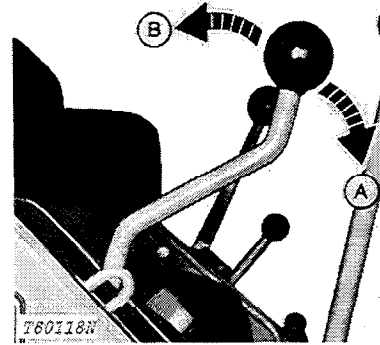

- A—Lower
- B—Raise

Fig. 29-Attachment Control Lever

Push lever forward to lower attachment, pull rearward to raise attachment.

Attachment control lever operational Yes No

23. Stabilizer Control Levers

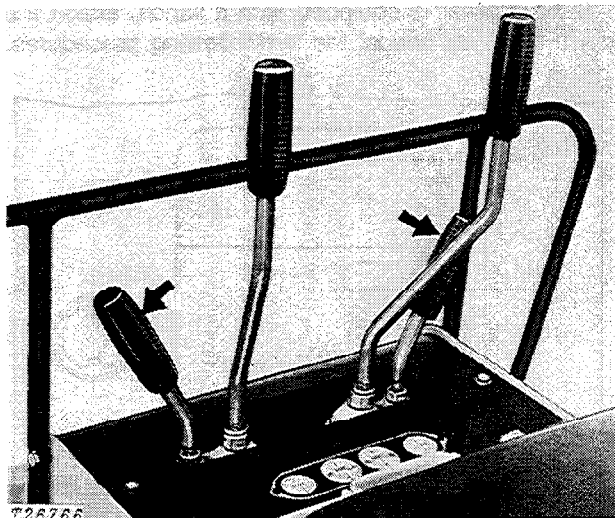
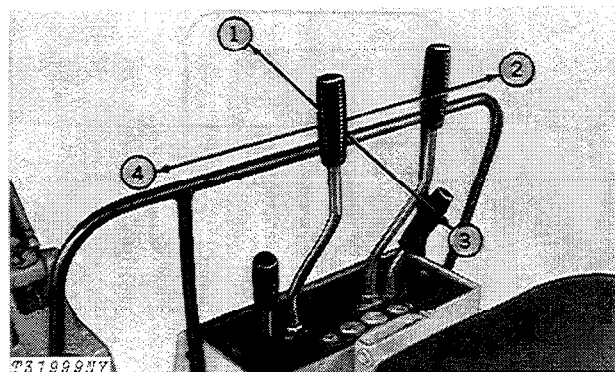

Fig. 30-Stabilizer Control Levers

To lower the stabilizers, move the control levers forward. To raise them, pull the levers rearward.

Stabilizer control levers operational Yes No

24. Boom and Swing Control Lever



1—Down 3—Up
 2—Right 4—Left

Fig. 31-Boom and Swing Control Lever

Lower the boom by moving the control lever forward. Raise the boom by moving the lever rearward. Swing left by moving the lever to the left and swing right by moving lever to the right.

Move the lever to one of the intermediate positions. The boom will move to the left or right at the same time it is being raised or lowered, performing two operations simultaneously.

Boom and swing control lever operational Yes No

25. Bucket and Dipperstick Control Lever

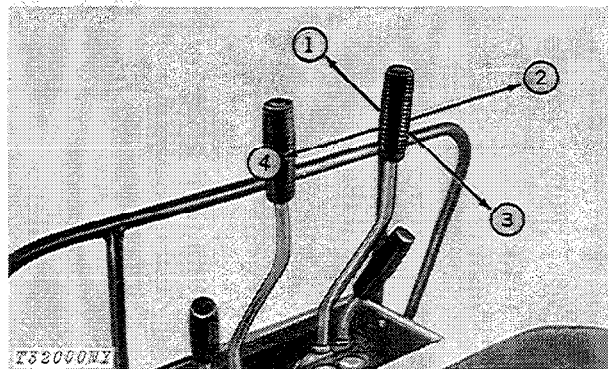

1—Bucket Out 3—Bucket In
 2—Dump 4—Load

Fig. 32-Bucket and Dipperstick Control Lever

Extend dipperstick by moving the control lever forward and retract it by moving the lever rearward.

Dump the bucket by moving the control lever to the right and load it by moving the lever to the left.

Move the lever to one of the intermediate positions. The dipperstick can be extended or retracted at the same time the bucket is being loaded or dumped.

Bucket and dipperstick control lever operational Yes No

26. Winch Control Lever

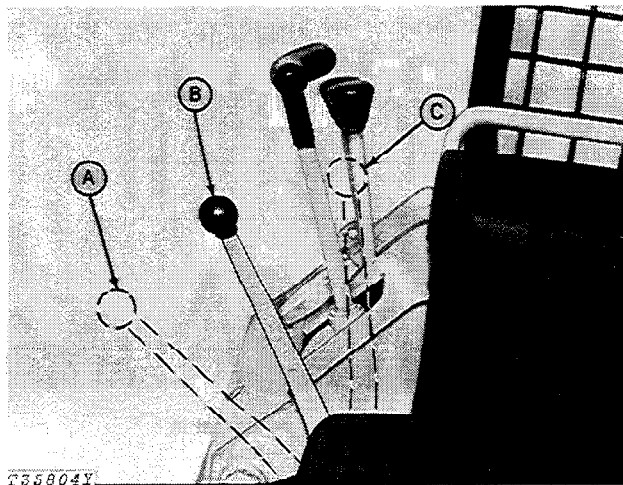

A—Wind
 B—Hold

C—Unwind

Fig. 33-Winch Control Lever

To operate the winch, start the engine and allow it to warm up properly. Adjust the engine speed from 1500 rpm to 2375 rpm.

The winch control lever has three positions: Hold, Wind, and Unwind.

When the control lever is in the center position, the winch is in the "HOLD" position. In this position, the winch brake prevents the cable drum from rotating.

To release the cable, move the control lever rearward to the "UNWIND" position. This allows the cable drum to "free-spool" and unwind by the "line-pull." The control lever will remain in the "UNWIND" position until released when it will return to the "HOLD" position.

To wind the cable, push the lever forward to the "WIND" position. The winch will continue to wind until the lever is released. The engine speed can be varied between 1500 rpm and 2375 rpm to regulate the winch wind-in speed. When the control lever is released, the lever will return to the "HOLD" position.

Winch control lever operational Yes No

27. Attaching Cable to Winch Drum

If the crawler is equipped with a winch, attach the winch cable by one of the two following procedures.

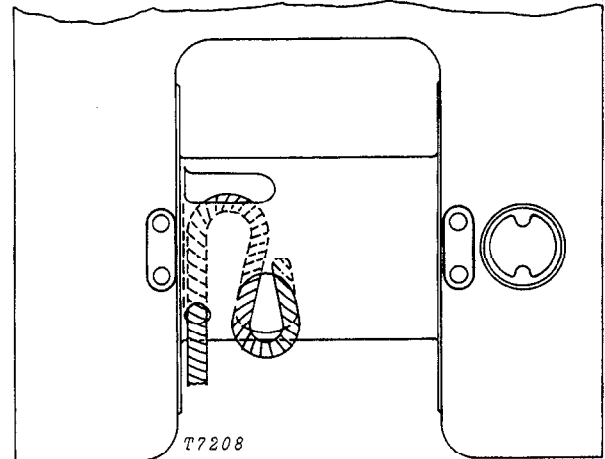

Fig. 34-Attaching Cable to Winch Drum

Thread cable through winch drum, fold end of cable back into drum, and pound it in.

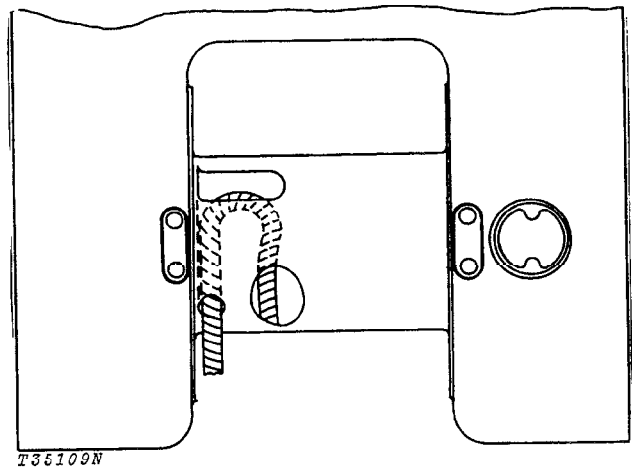

Fig. 35-Attaching Cable To Winch

To conform to certain state laws, the winch cable must be attached to the winch drum so that it can come loose if the cable is unwound.

Thread the cable through the winch drum as shown above and wind the cable onto the drum.

NOTE: When the cable is attached to the winch in this manner, unwinding the cable below five turns on the drum will allow the cable to disconnect from the drum.

Winch cable attached correctly Yes No



Suggest:

If the above button click is invalid.

Please download this document

first, and then click the above link

to download the complete manual.

Thank you so much for reading

28. Electric Return-to-Dig

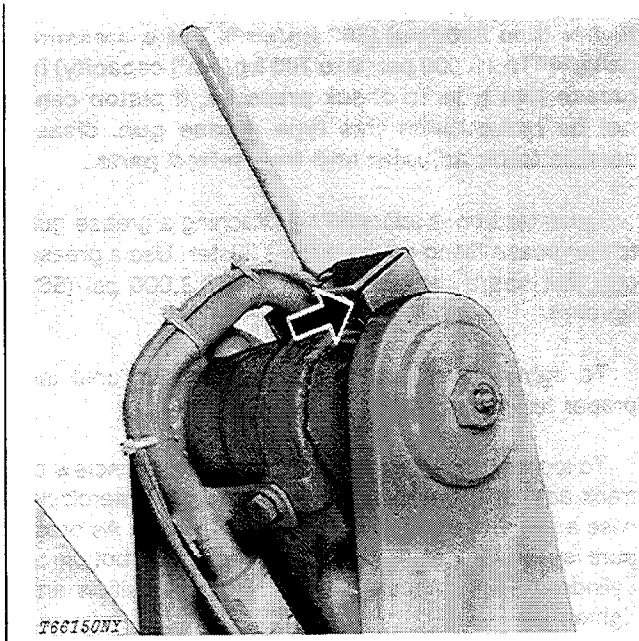

Fig. 36-Electric Return-To-Dig Switch

If adjusted properly, the bucket will be positioned in level or dig position when the boom is lowered to the ground.

To adjust the bucket positioner, loosen the two screws on top of the return-to-dig support. Adjust roller on boom switch lever so it is at least to the center of the tube when looking down the tube bore. Tighten the two screws.

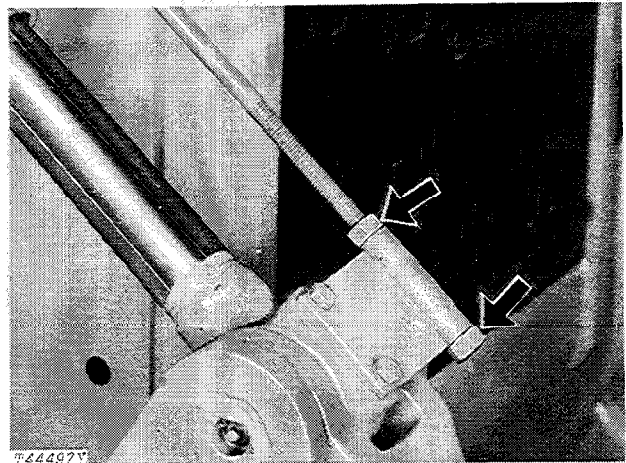

Fig. 37-Adjusting Indicator

To adjust the indicator, loosen the two nuts holding the indicator rod. Level the bucket and position the indicator rod so the end is flush with the end of the tube. Tighten the two nuts.

To adjust the spool switch on the control valve, loosen the two screws holding the switch. Position the switch so that the actuator pin will depress the lever on the bottom of the spool switch with the control valve handle in the bucket roll-back position.

<i>Electric return-to-dig operational</i>	Yes	No
<i>Electric return-to-dig adjusted</i>	Yes	No

<https://www.ebooklibonline.com>

Hello dear friend!

Thank you very much for reading.

Enter the link into your browser.

The full manual is available for immediate download.

<https://www.ebooklibonline.com>